

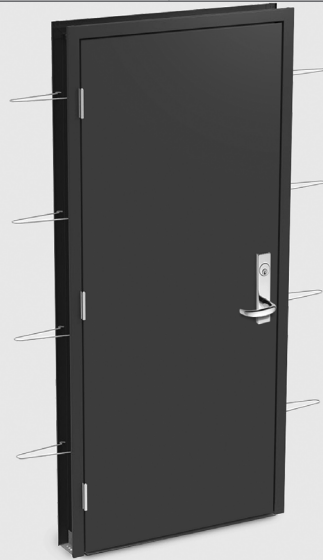

**Republic**  
DOORS AND FRAMES

# Price book

Effective March 1, 2024



## Customer Care

Our Customer Care Representatives are available for questions or assistance.

**800-733-3667**

### Customer Service

Press **1**  
 Republic.Order.Entry@allegion.com

### Technical Support

Republic is backed by a knowledgeable Product Support team that can be reached at:

**877-671-7011**

Follow the prompts to select Product Support, then Doors and Frames, then Republic.

The team may also be contacted at:

Doors\_Frames\_TechProdSupport@allegion.com

### List Price Estimating

Republic Factories and Service Centers  
 Republic.Estimating@allegion.com

www.republicdoor.com

## Administrative offices

### Allegion administrative office

11819 N. Pennsylvania St.  
 Carmel, IN 46032  
[allegion.com/us](http://allegion.com/us)

## Request for quote

### Carolinas

(North Carolina, South Carolina, Virginia)  
[Carolinas.Quotes@allegion.com](mailto:Carolinas.Quotes@allegion.com)

### Central

(Illinois, Iowa, Kansas, Missouri, Nebraska)  
[Central.Quotes@allegion.com](mailto:Central.Quotes@allegion.com)

### Chicago

(Northern Illinois, Wisconsin)  
[Chicago.Quotes@allegion.com](mailto:Chicago.Quotes@allegion.com)

### Florida

[Florida.Quotes@allegion.com](mailto:Florida.Quotes@allegion.com)

### Metro New York

(Metro New York, Northern New Jersey)  
[Metro.Quotes@allegion.com](mailto:Metro.Quotes@allegion.com)

### Michigan

[Michigan.Quotes@allegion.com](mailto:Michigan.Quotes@allegion.com)

### Mid Atlantic North

(New York, Western Pennsylvania)  
[Mid.Atlantic.North.Quotes@allegion.com](mailto:Mid.Atlantic.North.Quotes@allegion.com)

### Mid Atlantic South

(Delaware, Eastern Pennsylvania, Maryland, Northern Virginia, Southern New Jersey, Washington DC)  
[Mid.Atlantic.South.Quotes@allegion.com](mailto:Mid.Atlantic.South.Quotes@allegion.com)

### Midwest

(Indiana, Kentucky, Ohio, West Virginia)  
[Midwest.Quotes@allegion.com](mailto:Midwest.Quotes@allegion.com)

### Mountain States

(Colorado, Idaho, Montana, Nevada, Utah, Wyoming)  
[Mtn.States.Quotes@allegion.com](mailto:Mtn.States.Quotes@allegion.com)

### New England

(Connecticut, Maine, Massachusetts, New Hampshire, Rhode Island, Vermont)  
[NewEngland.Quotes@allegion.com](mailto:NewEngland.Quotes@allegion.com)

### North Central

(Minnesota, North Dakota, South Dakota)  
[NorthCentral.Quotes@allegion.com](mailto:NorthCentral.Quotes@allegion.com)

### Northern California

[NoCal.Quotes@allegion.com](mailto:NoCal.Quotes@allegion.com)

### Northwest

(Alaska, Oregon, Washington)  
[Northwest.Quotes@allegion.com](mailto:Northwest.Quotes@allegion.com)

### South

(Alabama, Georgia, Louisiana, Mississippi, Tennessee)  
[South.Quotes@allegion.com](mailto:South.Quotes@allegion.com)

### Southern California

(Southern California, Hawaii)  
[SoCal.Quotes@allegion.com](mailto:SoCal.Quotes@allegion.com)

### Southwest

(Arizona, New Mexico)  
[Southwest.Quotes@allegion.com](mailto:Southwest.Quotes@allegion.com)

### Texas

(Arkansas, Texas, Oklahoma)  
[Texas.Quotes@allegion.com](mailto:Texas.Quotes@allegion.com)

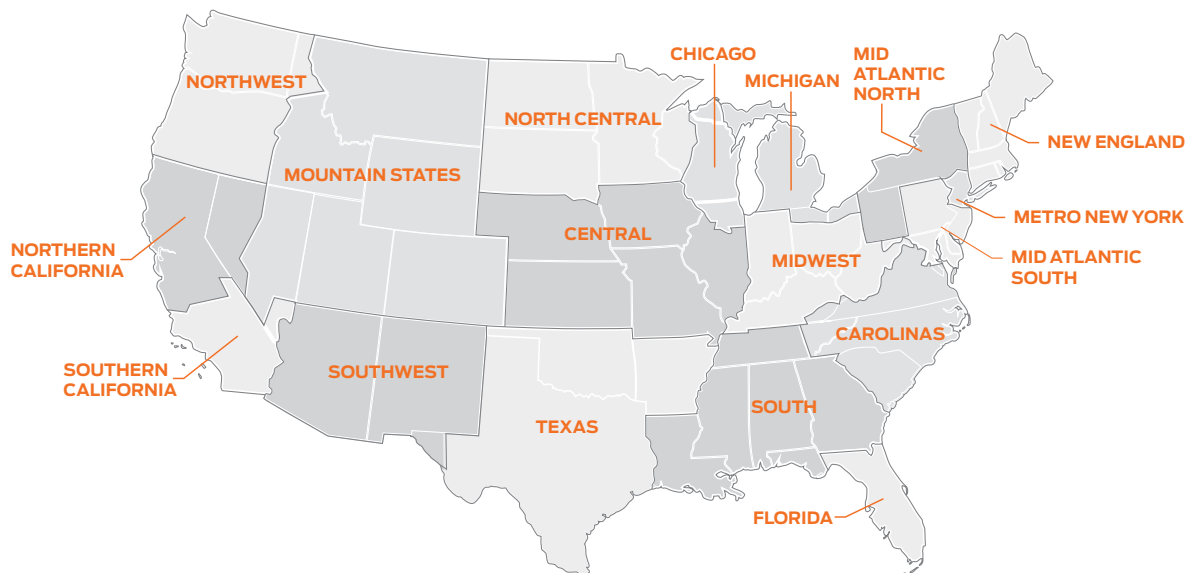

## Contents

<b>Doing business with Allegion</b> .....	<b>4</b>	<b>Specialty</b> .....	<b>46</b>
<b>General</b> .....	<b>5</b>	Lead lined doors and frames.....	46
Conditions of sale.....	5	Bullet resistant doors and frames.....	50
Abbreviations.....	7	DF Series.....	54
Weights.....	9	Hurricane/Wind resistant.....	58
<b>Doors</b> .....	<b>16</b>	Sound transmission control (STC).....	62
DP Series.....	16	<b>Sticks</b> .....	<b>70</b>
Honeycomb.....	18	SE Series.....	70
Insulated.....	21	Borrowed lites.....	73
Steel stiffened.....	24	Cut-N-Notch and Panels.....	76
Embossed.....	27	<b>Engineering</b> .....	<b>82</b>
<b>Frames</b> .....	<b>31</b>	<b>Valu-Pac</b> .....	<b>86</b>
Universal ME Series.....	31	<b>Door parts</b> .....	<b>90</b>
Drywall MH Series.....	35	<b>Frame parts</b> .....	<b>95</b>
Double egress ME Series.....	39	<b>Hardware</b> .....	<b>102</b>
Double egress MH Series.....	43		

### Policies and documents

The purchase of Allegion products is governed by the Allegion Authorized Seller Program. For program terms and conditions, and other program details, please visit: [www.allegion.com/AuthorizedSeller](http://www.allegion.com/AuthorizedSeller).

For Warranty information, visit [us.allegion.com/warranty](http://us.allegion.com/warranty) or contact Customer Service at 877-671-7011.



Online ordering is available through Overtur™ Estimate and Order (OEO)

OEO offers much more than placing online orders including:

- Provides net price for direct customers and list price for indirect customers, integrator partners and end-users
- Online Ordering for direct customers
- Automated price updates
- Ability to export price lists and cross-reference guides in Excel
- Configuration and configuration reports, including e-lock configurations
- Request a quote or quote revision from an estimate
- Keying Guide
- Library pre-built hardware sets

How to get it:

1. Login or register at <http://360portal.allegion.com>
2. Find the Estimate and Order Icon and follow the instructions to request access
3. The Online Ordering team will begin working on your access with your Allegion Sales Representative

#### Traditional ordering methods:

Email: [Republic.Order.Entry@allegion.com](mailto:Republic.Order.Entry@allegion.com)

When using traditional ordering methods, list the product attributes in the order outlined in this price book, which follow the ACN format guidelines.

#### Training and Troubleshooting



Scan the QR Code to access our resource center or visit

<https://support.oeo.allegion.com/hc/en-us>

Questions or issues should be reported to [Online.Ordering.Support@allegion.com](mailto:Online.Ordering.Support@allegion.com) for escalation

CONDITIONS OF SALE

1. **CONFORMANCE TO REGULATIONS** - Manufacture, shipment and delivery are subject to any prohibition, restriction, priority, allocation regulation or condition imposed by or on behalf of the United States of America which may prevent or interfere with fulfillment of this order.
2. **SELLER'S ACCEPTANCE** - Until accepted in writing on this form by Republic Doors & Frames ("Seller"), Buyer's order shall constitute an offer to purchase; when so accepted by Seller, this form shall constitute the entire contract between the parties [and Seller shall not be bound by any terms, conditions, representations, or warranties, express or implied, except as state herein]. It is understood by the parties, and Buyer hereby agrees, that no term or condition contained in any order submitted by Buyer which is inconsistent with, additional to or different from the terms and conditions stated herein shall be binding on Seller unless Specifically agreed to by Seller in a written acknowledgment or acceptance; unless Seller specifically so agrees, any inconsistent, additional or different terms or conditions appearing in any order submitted by Buyer shall be deemed waived by Buyer. Receipt by Buyer of Seller's acceptance of goods without prompt objection to the terms and conditions herein set forth shall constitute acceptance by Buyer of such terms and conditions. It is understood that Seller's acceptance of Buyer's order is subject to credit approval.
3. **GENERAL CONTRACT** - Seller shall not be bound by the provisions of any contract and related documents governing the general construction requirements except for that portion of the specifications, unless modified in Seller's Acknowledgment, which describes the scope of Sellers work.
4. **DELAY** - In no event shall Seller be liable for any claims for any consequential or any other damages resulting from failure or delay in delivery of material and/or field labor (if field labor is included as part of this order). Seller will endeavor to ship promptly and to make delivery on the date requested on the front hereof; however, time is not of the essence. It is understood that Seller cannot guarantee any time for delivery; that delivery to the initial carrier shall constitute delivery to Buyer; that Seller's responsibility ceases upon delivery in good order to such carrier; and that all goods are shipped at Buyer's risk. In any event, Seller will not be liable for any delay or failure in delivery or shipment of goods or for any default or failure to perform this contract, or for any damages suffered by reason thereof, when such delay, failure or default is directly or indirectly due to accident (in manufacture or otherwise), fire, flood, riot, war, embargo, labor dispute or stoppage, inadequate transportation, shortage of material or supplies, delay or default on the part of the Seller's vendor, regulation by any governmental authority or any like or dissimilar cause beyond Seller's control. In the event of the occurrence of any such cause or contingency, Seller may extend the delivery schedule of this contract for the duration of such cause or contingency or, at its option, cancel this contract in whole or in part without liability.
5. **PARTIAL DELIVERY** - Partial delivery shall be accepted by the Buyer and paid for at the price and on the terms herein stated. Any partial delivery of merchandise hereunder, whether or not provided for herein, shall constitute a separate sale, and payment therefor shall be separately made when due.
6. **CLAIMS** - Claim for errors, deficiencies or imperfections or delay not covered by Section 3 above will not be considered unless made in writing within 30 days after receipt of material. Seller, at its option, will replace or repair such materials as proven defective, or to allow for credit for their return. Seller will not accept the return of materials for credit or replacement without its previous written authority for such return. If materials appear defective, Buyer should discontinue their use and notify Seller Promptly so that Seller may investigate. Seller will not allow any claim for labor or expense occasioned by the use of defective materials, nor be responsible for damages beyond Seller's price of the defective material. Seller shall not be liable for any claims for consequential damages whether founded in contract or in tort. Risk of loss involving materials should be F.O.B. shipping point, even though transportation costs may be included in price. Risk of loss shall be borne by Buyer and Buyer shall pursue claims with the carrier in the event of loss or damage in transit. Seller shall not be liable for liquidated damages. Expenses in connection with detention of carrier's equipment at destination shall be for the account of Buyer. The remedies to Buyer hereunder are exclusive.
7. **INDEMNIFICATION** - Seller's obligation to indemnify Buyer for any cause, except for patent infringement as provided in this Acknowledgment shall be limited to the established sole negligent acts of Seller's agents and employees.
8. **CANCELLATION** - After acceptance of Seller, this contract may not be canceled or modified, or releases hereunder held be Buyer after the order is in process, except by Seller's written agreement. If any cancellation or modification is agreed to by Seller, Buyer will promptly pay all reasonable engineering and other expenses incurred by Seller prior to its agreement to such cancellation or to be incurred by Seller in connection with such modification.
9. **PAYMENT TERMS** - The terms of payment specified on the front hereof shall be subject to change or limitation by Seller at any time either before or after delivery of any part of the goods under this contract, and Seller may demand payment in cash before delivery. Delivery may be withheld or shipment stopped in transit on an accepted order without any liability on the part of the Seller if, in the Seller's opinion, Buyer's ability to pay for the goods on the terms and conditions stated herein is in doubt.
10. **LIENS** - Seller shall not be required to waive its right of Mechanic's Lien in advance of payment.

11. TAXES - Any tax, excise, duty or other governmental charge, whether federal, state, municipal or foreign, now or hereafter levied upon the manufacture, sales, use of shipment of goods contracted for or sold hereunder will be charged to and paid for by Buyer. Tax exemption certificates acceptable to such taxing authorities will be accepted in lieu of such payment.
12. SELLER'S OPTIONS - If Buyer shall fail to make payments on this or any other order in accordance with Seller's terms, or if Seller shall have any doubt as to Buyer's responsibility, Seller may suspend performance hereunder, except upon receipt of security satisfactory to Seller.
13. COLLECTION - In the event Seller is forced to place the Buyer's account for collection, Buyer agrees to pay all reasonable costs of collection including, but not limited to, reasonable attorney's fees and court costs.
14. QUANTITY, WEIGHT AND SIZE - Material, unless otherwise provided shall be invoiced in accordance with Seller's published schedules of weights, areas, bundles and standard lengths, which invoicing shall govern settlement in absence of a contrary showing.
15. SHOP PAINT - Where a shop coat of paint is specified, it shall mean one temporary protective coat of Seller's standard shop paint and no special treatment, field or permanent painting of any kind is included unless expressly stated on the face hereof.
16. CHANGES IN WORK - Subsequent changes in the scope of the work required of seller shall be subject to any adjustment in price to be agreed upon by Buyer and Seller prior to any obligation of Seller for such changes, and such adjustment shall not be affected by the decision of third parties.
17. LITERATURE AND DESIGN - Material unless otherwise provided shall be in accord with Seller's literature, unless modified in the interest of improvement, in which event it shall be deemed in accord with such literature. Seller assumes no responsibility for design prepared by others.
18. TRANSPORTATION ADJUSTMENT - When the price includes transportation it shall be adjusted to the increase or decrease in transportation rates at the time of shipment with rates at date this order is acknowledged.
19. INSPECTING AND TESTING - Seller shall not be liable for inspecting and testing charges unless expressly stated on the face hereof.
20. PATENTS - Seller shall indemnify and save harmless Buyer from any judgement for damages and cost which may be rendered against Buyer in any suit brought against Buyer on account of the infringement by the materials, per se, supplied by Seller hereunder of any United States patent, provided prompt written notice be given Seller of the bringing of any such suit and an opportunity be given Seller to settle or defend the same as Seller may see fit, provided further that every reasonable assistance which Seller may require in defending any such suit be rendered to Seller by Buyer, the forgoing states the entire liability of Seller to Buyer for patent infringement.
21. APPROVAL OF DRAWINGS - If Seller prepares drawings or placing details, approval thereof by the Buyer or his representative or the representative of the owner of the project for which Seller's materials are regarded as a final interpretation of all other documents, with respect to such drawings or details, and constitute authority for Seller to furnish material in accordance with those drawings or details.
22. DESIGN SAFETY FACTOR - Buyer agrees to any design safety factor provided in the products covered by this transaction is to accommodate variations in the properties of materials, manufacturing and operating conditions, and design assumptions, and under no condition should be considered as implying authorization for or protection against loads on such products which exceed the design limits.
23. COLLATERAL MATERIALS AND LABOR - This order does not include: collateral steel for fastening such material, ornamental iron, anchor bolts, glass, putty, glazing, glass cleaning, field painting, grouting, pointing, caulking, or any other material or labor unless expressly stated on the face hereof.
24. ARBITRATION - Neither Buyer or Seller shall be required to submit to arbitration in the event of any dispute unless Buyer and Seller shall agree in writing hereto at the time of such dispute, and arbitration is not to be a condition precedent, except by mutual agreement of the parties in writing, to the right of legal action by either part.
25. WARRANTY - Seller warrants to Buyer that it will, at its option and in its sole discretion, furnish F.O.B. McKenzie, TN (or other point of origin), a replacement for, repair, or refund the purchase price to Buyer of any goods of its manufacture or part or portion thereof proved to its satisfaction to be defective in workmanship for material under normal use and service within one year (365 days) from the date of delivery to such Buyer, provided that notice of such defect is given to Seller within such one year (365 days) period. Seller makes no warranty with respect to items on the reverse side here of supplied to Buyer by Seller but manufactured by others, except to the extent of any warranty given to Seller by such others. Buyer further agrees that Seller is not responsible for any other conditions over which Seller has no control. In no case shall Seller be liable for consequential damages arising from breach of any of the foregoing warranties. THERE IS NO IMPLIED WARRANTY OF MERCHANTABILITY OR IMPLIED WARRANTY OF FITNESS FOR A PARTICULAR PURPOSE OR ANY OTHER WARRANTY, EXPRESS OR IMPLIED, AND SELLER WILL NOT BE RESPONSIBLE FOR ANY DAMAGES WHATSOEVER, OR FOR ANY LABOR, TRANSPORTATION OR OTHER COSTS OR EXPENSES RELATING TO SUCH REPLACEMENT OR SUCH REPAIR, INCLUDING ANY INDIRECT, INCIDENTAL OR CONSEQUENTIAL DAMAGES. This Warranty is for Buyer's exclusive benefit and is not assignable or transferable, nor is Buyer permitted to present to its customer, or any third party, that it may rely on the Warranty.

### ABBREVIATIONS

ACT	Active
ANSI	American National Standards Institute
AR	Adams Rite
AST	Astragal
AUTO	Automatic
B	Beveled lock edge
BH	Binding Head
BJ	Blank Jamb
BS	Backset
C	Cylindrical Lock Prep (2-3/8" Backset)
CAD	Cadmium
CB	Cross Buck
CERT	Certified
CH	Cylindrical Lock Prep (2-3/4" Backset)
CHOL	Cylindrical Lock Edge Prep Omit Face Cutout
CL	Centerline
C/O	Cutout
CR	Closer reinforcement
CRS	Cold rolled steel
COMM	Communicating
CONC V-ROD	Concealed Vertical Rod
CVR	Concealed Vertical Rod
COR/RUS	Corbin/Russwin
CTSK	Countersunk
CW	Continuous Weld
CY	Inverted Blade Louver
CYL	Cylinder
DE	Four (4) Channel Door Without McKenzie Edge
DL	Four (4) Channel Door With Lapped Edge Seams
DP	Pan and Lid Door
DS	Double Swing
DDLK	Dead lock
DEV	Device
DD	Dutch door
DRS	Doors
ELEC	Electric
P1	Embossed 1 Panel Door
P2	Embossed 2 Panel Door
P4	Embossed 4 Panel Door
P6	Embossed 6 Panel Door
P8	Embossed 8 Panel Door
F/AST	Flat Bar Astragal
F	Flush
FA	Folger Adams
FB	Flushbolt
FC	Floor Clearance
FG	Full Glass

### ABBREVIATIONS

F.H.	Flat Head
FL	Full Louver
FRM	Frame
FW	Face Weld
G	Half Glass (G2, G3, G4, G6)
GA	Gauge
GB	Glazing Bead
GBO	Glass By Others
GLV	Galvanized/Galvanneal
GOV'T	Government
GSD	Guide Sheet Doors
GSF	Guide Sheet Frames
HJ	Hinge Jamb
HVY	Heavy
H	Heavy Weight Hinge (example: 5H)
HS	Half Surface
HDWE	Hardware
HNG	Hinge
HNG-BS	Hinge Backset
HR	Hour
INA	Inactive Door
INS	Insulated - Polystyrene
INT	Intermediate
ITS	Intertek Testing Services
I/S	Inside
I/S-PNL	Inside Panel
L	Louver
LF	Leaf
LH	Left Hand
LHR	Left Hand Reverse
LIN	Lineal
LOC	Location
M	Mortise Lock Preparation
MAS	Masonry Anchor
ME	Masonry Frame (Mitered Corner)
MH	Drywall Frame (Mitered Corner)
MK#	Mark Number
MIN	Minute
MISC RNF	Miscellaneous Reinforcement
MOD	Modifiable Door
MOL	Mortise Lock Edge Prep (No Face Cutout)
MOLP	Mortise Lock Edge Prep with Face Prep
MRC	Monarch
M-RNF	Mortise Exit Reinforcement
M.S.	Machine Screw
N	Narrow Lite
NH	Non-Handed

### ABBREVIATIONS

NT	Non-Template
NS	Non-Standard
O.H.	Oval Head
OH	Omit Hinge
OHOL	Omit Hinge/Omit Lock Prep
OL	Omit All Lock and Latch Prep
OS	Omit Strike
OBS	Open back strike
OS/PNL	Outside Panel
OSH	Omit Silencer Hole
PA	Parallel Arm
PHIL	Phillips Head
PNL	Panel
PIP	Panel in place
PLT	Plate
POA	Prepared Opening Anchor
PR	Pair
PREP	Preparation
PP-RNF	Push Pull Reinforcement
PS	Polystyrene
RH	Right Hand
RHR	Right Hand Reverse
RIM	Rim Exit Device
RIM-RNF	Rim Exit Device Reinforcement
RIX	Rixson
RNF	Reinforcement
RPL	Remove Panel
SE	Sticks Masonry Profile
SCR	Sleeve Closer reinforcement
S.D.S.	Self Drilling Screw
SGT	Sargent
SH	Sticks Drywall Profile
SJ	Strike Jamb
SLB	Seamless-Bondo
SLW	Seamless Weld
SS	Steel Stiffened
SSA	Steel Stud Anchor
STC	Sound Transmission Class
STD	Standard
S.T.S.	Self Tapping Screw
SUAW	Set Up and Weld
SIL	Silencer
SPC	Special
S	Standard Weight Hinge
STK	Strike
SB	Surface Bolt
S-HDWE	Surface Hardware

### ABBREVIATIONS

TAPPL	Tap Plate
TR	Temperature Rise
T/L	Top Leaf
UL	Underwriters Laboratories
URT	Urethane
UNIFIT	Metal Replacement Doors
UNIV	Universal
V	Vision Lite
V-ROD	Vertical Rod
VIEW	Viewer
VD	Von Duprin
W/O	Without
WD	Wood
WH	Warnock Hersey
WMA	Wire Masonry Anchor
WOPOA	Welded on Prepared Opening Anchor
WSA	Wood Stud Anchor
WT	Weight
WD-STUD	Wood Stud
478	4-7/8" Strike

#### Examples

- For doors with panel in place (PIP), the description will read 22x33G C/O-PIP.
- For doors with the vision insert (GBO) or louver installed, the description will read 22x33G or 24x24L.
- For doors with cutout and remove panel, the description will read 22x33G C/O-RPL.

Please note that for steel stiffened doors both the vision insert (GBO) and louver cutouts will receive reinforcing channels unless otherwise instructed.

#### DOOR AND FRAME SIZES ARE DESIGNATED AS FOLLOWS:

30	=	3'0"
310	=	3'10"
70	=	7'0"
710	=	7'10"
100	=	10'0"
3070	=	3'0" Wide x 7'0" High

Nominal Sizes, Width and Height



DOOR WEIGHTS

SIZE	DP 20	DP18	DL 20	DL 18	DL 16	DE 14	DL 18 STEEL STIFFENED	DL 16 STEEL STIFFENED	DE 14 STEEL STIFFENED
2068	N/A	N/A	49	62	76	84	78	98	106
2468									
2668	57	75	61	77	95	106	98	123	133
2868	61	80	65	82	102	113	104	131	141
21068	65	85	69	87	108	120	111	139	50
3068	69	90	73	92	114	127	117	148	159
3468	76	101	81	103	127	141	130	164	177
3668	80	106	86	108	133	148	137	172	186
3868	84	111	90	113	140	155	143	180	194
31068	88	116	94	118	146	162	150	189	203
4068	91	121	98	123	152	169	156	197	212
4010	N/A	N/A	N/A	N/A	N/A	N/A	206	232	295
2070	N/A	N/A	51	65	80	89	82	103	111
2470	56	74	60	75	93	103	96	121	130
2670	60	79	64	81	100	111	102	129	139
2870	64	84	68	86	107	118	109	138	148
21070	68	90	72	92	113	126	116	146	158
3070	72	95	77	97	120	133	123	155	167
3470	N/A	100	N/A	102	127	140	130	164	176
3670	N/A	111	N/A	113	140	155	143	181	195
3870	N/A	116	N/A	119	147	163	150	189	204
31070	N/A	121	N/A	124	153	170	157	198	213
4070	N/A	127	N/A	129	160	177	164	207	223
5070	N/A	N/A	N/A	169	196	258	219	241	329
2072	N/A	N/A	N/A	66	82	91	84	106	114
2472	N/A	N/A	N/A	77	95	106	98	123	133
2672	N/A	N/A	N/A	83	102	113	105	132	142
2872	N/A	N/A	N/A	88	109	121	112	141	152
21072	N/A	N/A	N/A	94	116	129	119	150	161
3072	N/A	N/A	N/A	99	123	136	126	159	171
3472	N/A	N/A	N/A	110	136	151	140	176	190
3672	N/A	N/A	N/A	116	143	159	147	185	199
3872	N/A	N/A	N/A	121	150	166	154	194	209
31072	N/A	N/A	N/A	124	153	170	157	198	213
4072	N/A	N/A	N/A	132	164	182	168	212	228
5072	N/A	N/A	N/A	173	201	265	221	249	313
2080	N/A	N/A	N/A	74	91	101	94	118	127
2480	N/A	N/A	N/A	86	107	118	109	138	148
2680	N/A	N/A	N/A	92	114	127	117	148	159
2880	N/A	N/A	N/A	99	122	135	125	157	170
21080	N/A	N/A	N/A	105	130	144	133	167	180
3080	N/A	N/A	N/A	111	137	152	141	177	191
3480	N/A	N/A	N/A	123	152	169	156	197	212
3680	N/A	N/A	N/A	129	160	177	164	207	223
3880	N/A	N/A	N/A	136	168	186	172	217	233
31080	N/A	N/A	N/A	142	175	194	1280	226	244
4080	N/A	N/A	N/A	148	183	203	187	236	254
5080	N/A	N/A	N/A	192	223	294	247	278	349

**ME SERIES 16 GAUGE FRAME WEIGHTS**

FRAME SIZE	5-3/4"	6-3/4"	7-3/4"	8-3/4"	10-3/4"	12-3/4"
<b>2068</b>	35	38	41	44	50	55
<b>2468</b>	36	39	42	45	51	56
<b>2668</b>	36	39	42	45	51	57
<b>2868</b>	37	40	43	46	52	58
<b>21068</b>	37	40	43	46	52	58
<b>3068</b>	37	40	43	46	52	59
<b>3468</b>	38	41	44	47	53	60
<b>3668</b>	38	41	45	48	54	60
<b>3868</b>	39	42	45	48	54	61
<b>31068</b>	39	42	45	49	55	61
<b>4068</b>	39	43	46	49	55	62
<b>4868</b>	42	45	48	52	58	65
<b>5068</b>	42	45	49	52	59	66
<b>5468</b>	43	46	50	53	60	67
<b>5868</b>	43	47	50	54	61	68
<b>6068</b>	44	47	51	54	61	68
<b>6868</b>	45	49	52	56	63	71
<b>7068</b>	45	49	53	57	64	71
<b>7468</b>	46	50	54	57	65	72
<b>7868</b>	47	51	54	58	66	73
<b>8068</b>	47	51	55	59	66	74
<b>10068</b>	53	57	61	66	74	83
<b>2070</b>	37	40	43	46	52	58
<b>2470</b>	37	40	43	46	52	59
<b>2670</b>	38	41	44	47	53	59
<b>2870</b>	38	41	44	47	53	60
<b>21070</b>	38	41	45	48	54	60
<b>3070</b>	39	42	45	48	54	61
<b>3470</b>	39	43	46	49	55	62
<b>3670</b>	40	43	46	49	56	62
<b>3870</b>	40	43	47	50	56	63
<b>31070</b>	40	44	47	50	57	64
<b>4070</b>	41	44	47	51	57	64
<b>4870</b>	43	47	50	53	60	67
<b>5070</b>	43	47	50	54	61	68
<b>5470</b>	44	48	51	55	62	69
<b>5870</b>	45	48	52	56	63	70
<b>6070</b>	45	49	52	56	63	71
<b>6870</b>	46	50	54	58	65	73
<b>7070</b>	47	51	54	58	66	73
<b>7470</b>	48	51	55	59	67	75
<b>7870</b>	48	52	56	60	68	76
<b>8070</b>	49	53	56	60	68	76
<b>10070</b>	54	59	63	67	76	85

FRAME SIZE	5-3/4"	6-3/4"	7-3/4"	8-3/4"	10-3/4"	12-3/4"
<b>2072</b>	37	40	43	46	52	59
<b>2472</b>	38	41	44	47	53	60
<b>2672</b>	38	41	45	48	54	60
<b>2872</b>	39	42	45	48	54	61
<b>21072</b>	39	42	45	49	55	61
<b>3072</b>	39	43	46	49	55	62
<b>3472</b>	40	43	47	50	56	63
<b>3672</b>	40	44	47	50	57	64
<b>3872</b>	41	44	47	51	57	64
<b>31072</b>	41	44	48	51	58	65
<b>4072</b>	41	45	48	52	58	65
<b>4872</b>	44	47	51	54	61	68
<b>5072</b>	44	48	51	55	62	69
<b>5472</b>	45	48	52	56	63	70
<b>5872</b>	45	49	53	57	64	71
<b>6072</b>	46	50	53	57	64	72
<b>6872</b>	47	51	55	59	66	74
<b>7072</b>	48	51	55	59	67	75
<b>7472</b>	48	52	56	60	68	76
<b>7872</b>	49	53	57	61	69	77
<b>8072</b>	49	53	57	61	69	77
<b>10072</b>	55	59	64	68	77	86
<b>2080</b>	42	45	48	52	58	65
<b>2480</b>	42	46	49	53	59	66
<b>2680</b>	43	46	50	53	60	67
<b>2880</b>	43	47	50	53	60	67
<b>21080</b>	43	47	50	54	61	68
<b>3080</b>	44	47	51	54	61	68
<b>3480</b>	44	48	52	55	62	70
<b>3680</b>	45	48	52	56	63	70
<b>3880</b>	45	49	52	56	63	71
<b>31080</b>	45	49	53	57	64	71
<b>4080</b>	46	50	53	57	64	72
<b>4880</b>	48	52	56	60	67	75
<b>5080</b>	49	53	57	61	68	76
<b>5480</b>	50	54	57	61	69	77
<b>5880</b>	50	54	58	62	70	78
<b>6080</b>	51	55	59	63	71	79
<b>6880</b>	52	57	61	65	73	82
<b>7080</b>	53	57	62	66	74	83
<b>7480</b>	54	58	62	67	75	84
<b>7880</b>	54	59	63	68	76	85
<b>8080</b>	55	60	64	68	77	86
<b>10080</b>	59	64	69	74	83	93

ME SERIES 14 GAUGE FRAME WEIGHTS

FRAME SIZE	5-3/4"	6-3/4"	7-3/4"	8-3/4"	10-3/4"	12-3/4"
2068	44	48	51	55	62	69
2468	45	49	52	56	63	71
2668	45	49	53	57	64	72
2868	46	50	53	57	65	72
21068	46	50	54	58	65	73
3068	47	50	54	58	66	74
3468	47	51	55	59	67	75
3668	48	52	56	60	68	76
3868	48	52	56	60	68	77
31068	49	53	57	61	69	77
4068	49	53	57	62	70	78
4868	52	56	60	65	73	82
5068	52	57	61	65	74	82
5468	53	58	62	66	75	84
5868	54	59	63	67	76	85
6068	55	59	64	68	77	86
6868	56	61	66	70	79	89
7068	57	61	66	71	80	89
7468	58	62	67	72	81	91
7868	58	63	68	73	83	92
8068	59	64	69	74	83	93
10068	66	71	77	82	93	104
2070	46	50	53	57	65	72
2470	47	50	54	58	66	74
2670	47	51	55	59	67	74
2870	47	51	55	59	67	75
21070	48	52	56	60	68	76
3070	48	52	56	60	68	77
3470	49	53	57	62	70	78
3670	50	54	58	62	70	79
3870	50	54	58	63	71	79
31070	51	55	59	63	72	80
4070	51	55	59	64	72	81
4870	54	58	63	67	76	85
5070	54	59	63	67	76	85
5470	55	60	64	69	78	87
5870	56	60	65	70	79	88
6070	56	61	66	70	79	89
6870	58	63	68	72	82	92
7070	58	63	68	73	83	92
7470	59	64	69	74	84	94
7870	60	65	70	75	85	95
8070	61	66	71	76	86	96
10070	68	73	79	85	96	107

FRAME SIZE	5-3/4"	6-3/4"	7-3/4"	8-3/4"	10-3/4"	12-3/4"
2072	47	50	54	58	66	74
2472	47	51	55	59	67	75
2672	48	52	56	60	68	76
2872	48	52	56	60	68	77
21072	49	53	57	61	69	77
3072	49	53	57	62	70	78
3472	50	54	58	63	71	79
3672	51	55	59	63	72	80
3872	51	55	59	64	72	81
31072	51	56	60	64	73	81
4072	52	56	60	65	73	82
4872	55	59	64	68	77	86
5072	55	60	64	69	78	87
5472	56	60	65	70	79	88
5872	57	61	66	71	80	89
6072	57	62	67	71	81	90
6872	59	64	69	74	83	93
7072	59	64	69	74	84	94
7472	60	65	70	75	85	95
7872	61	66	71	76	86	96
8072	62	67	72	77	87	97
10072	69	74	80	86	97	108
2080	52	56	60	65	73	82
2480	53	57	61	66	74	83
2680	53	58	62	66	75	84
2880	54	58	63	67	76	85
21080	54	59	63	67	76	85
3080	55	59	64	68	77	86
3480	55	60	65	69	78	87
3680	56	60	65	70	79	88
3880	56	61	66	70	79	89
31080	57	61	66	71	80	89
4080	57	62	67	71	81	90
4880	60	65	70	75	84	94
5080	61	66	71	76	86	95
5480	62	67	72	77	87	97
5880	63	68	73	78	88	98
6080	63	69	74	79	89	100
6880	65	71	76	81	92	102
7080	66	71	77	82	93	104
7480	67	72	78	83	94	105
7880	68	73	79	84	96	107
8080	69	74	80	86	97	108
10080	74	80	86	92	104	116

### MH SERIES 16 GAUGE FRAME WEIGHTS

FRAME SIZE	5-7/8"	6-1/4"	7-1/8"	8-1/4"	9"
<b>2068</b>	38	38	41	44	50
<b>2468</b>	36	39	42	45	51
<b>2668</b>	36	39	42	45	51
<b>2868</b>	37	40	43	46	52
<b>21068</b>	37	40	43	46	52
<b>3068</b>	37	40	43	46	52
<b>3468</b>	38	41	44	47	53
<b>3668</b>	38	41	45	48	54
<b>3868</b>	39	42	45	48	54
<b>31068</b>	39	42	45	49	55
<b>4068</b>	39	43	46	49	55
<b>4868</b>	42	45	48	52	58
<b>5068</b>	42	45	49	52	59
<b>5468</b>	43	46	50	53	60
<b>5868</b>	43	47	50	54	61
<b>6068</b>	44	47	51	54	61
<b>6868</b>	45	49	52	56	63
<b>7068</b>	45	49	53	57	64
<b>7468</b>	46	50	54	57	65
<b>7868</b>	47	51	54	58	66
<b>8068</b>	47	51	55	59	66
<b>10068</b>	53	57	61	66	74
<b>2070</b>	37	40	43	46	52
<b>2470</b>	37	40	43	46	52
<b>2670</b>	38	41	44	47	53
<b>2870</b>	38	41	44	47	53
<b>21070</b>	38	41	45	48	54
<b>3070</b>	39	42	45	48	54
<b>3470</b>	39	43	46	49	55
<b>3670</b>	40	43	46	49	56
<b>3870</b>	40	43	47	50	56
<b>31070</b>	40	44	47	50	57
<b>4070</b>	41	44	47	51	57
<b>4870</b>	43	47	50	53	60
<b>5070</b>	43	47	50	54	61
<b>5470</b>	44	48	51	55	62
<b>5870</b>	45	48	52	56	63
<b>6070</b>	45	49	52	56	63
<b>6870</b>	46	50	54	58	65
<b>7070</b>	47	51	54	58	66
<b>7470</b>	48	51	55	59	67
<b>7870</b>	48	52	56	60	68
<b>8070</b>	49	53	56	60	68

FRAME SIZE	5-7/8"	6-1/4"	7-1/8"	8-1/4"	9"
<b>2072</b>	37	40	43	46	52
<b>2472</b>	38	41	44	47	53
<b>2672</b>	38	41	45	48	54
<b>2872</b>	39	42	45	48	54
<b>21072</b>	39	42	45	49	55
<b>3072</b>	39	43	46	49	55
<b>3472</b>	40	43	47	50	56
<b>3672</b>	40	44	47	50	57
<b>3872</b>	41	44	47	51	57
<b>31072</b>	41	44	48	51	58
<b>4072</b>	41	45	48	52	58
<b>4872</b>	44	47	51	54	61
<b>5072</b>	44	48	51	55	62
<b>5472</b>	45	48	52	56	63
<b>5872</b>	45	49	53	57	64
<b>6072</b>	46	50	53	57	64
<b>6872</b>	47	51	55	59	66
<b>7072</b>	48	51	55	59	67
<b>7472</b>	48	52	56	60	68
<b>7872</b>	49	53	57	61	69
<b>8072</b>	49	53	57	61	69
<b>10072</b>	55	59	64	68	77
<b>2080</b>	42	45	48	52	58
<b>2480</b>	42	46	49	53	59
<b>2680</b>	43	46	50	53	60
<b>2880</b>	43	47	50	53	60
<b>21080</b>	43	47	50	54	61
<b>3080</b>	44	47	51	54	61
<b>3480</b>	44	48	52	55	62
<b>3680</b>	45	48	52	56	63
<b>3880</b>	45	49	52	56	63
<b>31080</b>	45	49	53	57	64
<b>4080</b>	46	50	53	57	64
<b>4880</b>	48	52	56	60	67
<b>5080</b>	49	53	57	61	68
<b>5480</b>	50	54	57	61	69
<b>5880</b>	50	54	58	62	70
<b>6080</b>	51	55	59	63	71
<b>6880</b>	52	57	61	65	73
<b>7080</b>	53	57	62	66	74
<b>7480</b>	54	58	62	67	75
<b>7880</b>	54	59	63	68	76
<b>8080</b>	55	60	64	68	77

<b>SE SERIES 16 GAUGE STICK WEIGHTS</b>						
<b>Stick Part</b>	<b>5-3/4"</b>	<b>6-3/4"</b>	<b>7-3/4"</b>	<b>8-3/4"</b>	<b>10-3/4"</b>	<b>12-3/4"</b>
Blank Jamb 10' 3"	21	23	25	27	30	34
Filler With Stop 10' 3"	12	14	16	18	21	25
Filler Without Stop 10' 3"	9	11	12	14	18	22
Blank Jamb 4" Face 10' 3"	29	30	32	34	38	42
6" Face Sill 10' 3"	41	43	45	47	52	56
8" Face Sill 10' 3"	50	52	54	56	60	64
10" Face Sill 10' 3"	58	60	62	64	68	72
12" Face Sill 10' 3"	66	68	70	72	77	81
Cased open Blank Jamb 10' 3"	19	21	23	24	28	32
Double Egress Blank Jamb 10' 3"	22	24	26	28	31	35
Blank Mull 10' 3"	34	36	38	40	43	47
Blank Mull 6' 8"	22	23	25	26	28	31
Blank Mull 7' 0"	23	25	26	27	30	32
Blank Mull 7' 2"	24	25	26	28	30	33
Blank Mull 8' 0"	27	28	30	31	34	37
2 Way Corner Post 10' 3"	49	51	53	54	58	62
3 Way Corner Post 10' 3"	50	52	54	55	59	63

<b>SH SERIES 16 GAUGE STICK WEIGHTS</b>					
<b>Stick Part</b>	<b>5-7/8"</b>	<b>6-1/4"</b>	<b>7-1/8"</b>	<b>8-3/4"</b>	<b>9"</b>
Blank Jamb 10' 3"	21	22	24	26	27

<b>SE SERIES 14 GAUGE STICK WEIGHTS</b>						
<b>Stick Part</b>	<b>5-3/4"</b>	<b>6-3/4"</b>	<b>7-3/4"</b>	<b>8-3/4"</b>	<b>10-3/4"</b>	<b>12-3/4"</b>
Blank Jamb 10' 3"	27	29	32	34	39	43
Filler With Stop 10' 3"	15	18	20	22	27	32
Filler Without Stop 10' 3"	11	13	16	18	23	27
Blank Jamb 4" Face 10' 3"	36	39	41	43	48	53
6" Face Sill 10' 3"	52	54	57	59	64	70
8" Face Sill 10' 3"	62	64	67	70	75	80
10" Face Sill 10' 3"	72	75	77	80	85	90
12" Face Sill 10' 3"	82	85	88	90	95	100
Cased open Blank Jamb 10' 3"	24	26	29	31	36	40
Double Egress Blank Jamb 10' 3"	28	30	33	35	40	44
Blank Mull 10' 3"	43	46	48	50	55	60
Blank Mull 6' 8"	28	30	31	33	36	39
Blank Mull 7' 0"	30	31	33	34	38	41
Blank Mull 7' 2"	30	32	33	35	38	42
Blank Mull 8' 0"	34	36	37	39	43	47
2 Way Corner Post 10' 3"	62	64	67	69	74	78
3 Way Corner Post 10' 3"	63	65	68	70	75	79

SIZE	STC 50 HM DOOR	FEMA 320/361 DOOR	8-3/4" DEPTH FEMA FRAME	BULLET RESISTANT LEVEL 3 DOOR	8-3/4" DEPTH BULLET RESISTANT LEVEL 3 FRAME	BULLET RESISTANT LEVEL 8 DOOR	8-3/4" DEPTH BULLET RESISTANT LEVEL 8 FRAME	1/16" LEAD LINED DOOR	8-3/4" DEPTH 1/16" LEAD LINED FRAME
2068	130	125	56	143	66	275	86	132	78
2468	151	146	57	167	67	321	88	154	79
2668	162	156	58	179	68	344	89	165	80
2868	173	167	58	190	69	367	89	176	81
21068	183	177	59	202	69	389	90	187	82
3068	194	188	60	214	70	412	91	198	83
3468	216	208	61	238	72	458	93	220	84
3668	227	219	61	250	72	481	94	231	85
3868	237	229	62	262	73	504	95	242	86
31068	248	240	63	274	74	527	96	253	87
4068	259	250	63	286	74	550	97	264	88
5068	N/A	N/A	N/A	357	79	687	103	330	93
2070	136	131	58	150	69	289	89	139	81
2470	159	153	60	175	70	337	91	162	83
2670	170	164	60	187	71	361	92	173	84
2870	181	175	61	200	72	385	93	185	84
21070	193	186	61	212	72	409	94	196	85
3070	204	197	62	225	73	433	95	208	86
3470	227	219	63	250	74	481	97	231	88
3670	238	230	64	262	75	505	98	243	89
3870	249	241	64	275	76	529	99	254	89
31070	261	252	65	287	77	553	100	266	90
4070	272	263	66	300	77	577	101	277	91
5070	N/A	N/A	N/A	375	82	722	106	347	96
2072	139	134	60	154	70	296	91	142	83
2472	162	157	61	179	72	345	93	166	84
2672	174	168	61	192	72	369	94	177	85
2872	186	179	62	205	73	394	95	189	86
21072	197	190	63	218	74	419	96	201	87
3072	209	202	63	230	74	443	97	213	88
3472	232	224	64	256	76	492	99	237	89
3672	244	235	65	269	77	517	100	248	90
3872	255	246	66	282	77	542	101	260	91
31072	267	258	66	294	78	566	102	272	92
4072	278	269	67	307	79	591	103	284	93
5072	N/A	N/A	N/A	384	83	739	108	355	98
2080	155	150	66	171	77	330	101	158	91
2480	181	175	67	200	79	385	103	185	93
2680	194	188	67	214	79	412	103	198	94
2880	207	200	68	229	80	440	104	211	95
21080	220	213	69	243	81	467	105	224	95
3080	233	225	69	257	82	495	106	238	96
3480	259	250	71	286	83	550	108	264	98
3680	272	263	71	300	84	577	109	277	99
3880	285	278	72	314	84	605	110	291	100
31080	298	288	72	329	85	632	111	304	100
4080	311	300	73	343	86	660	112	317	101
5080	N/A	N/A	N/A	429	92	825	119	N/A	N/A

this page intentionally blank

## DP SERIES

### Honeycomb/Polystyrene

refer to technical data sheet on page 9

- Thickness – 1-3/4"
- Actual Door Size – Door undersized from nominal by 1/4" in width and 7/8" in height. Standard undercut is 3/4".
- Hinge Edge and Reinforcement – Hinge edge is square edge and includes reversible hinge filler plate. Standard 7 gauge hinge reinforcement.
- Lock Edge – Square edge, 14ga reinf. for mortise or 16ga for cylindrical locks. Compliant with ANSI A1115 standards.
- Edge Seams – Visible seam
- Top Channel – Top Channel is a 16 gauge flush channel, projection welded at a maximum 2-1/2" on center. (Optional - Inverted)
- Bottom Channel – Bottom Channel is an inverted 16 gauge channel, projection welded at a maximum 2-1/2" on center
- Face Skins – 20 gauge or 18 gauge, Cold rolled steel or A60 Galvannealed
- Closer Reinforcement (Optional) – 14 gauge standard
- Size Availability – Please see price sheet for sizes as indicated
- SDI 100 Level/Model
  - Level 1 Model 1 (Standard Duty, minimum 20 gauge, hollow steel composite)
  - Level 2 Model 1 or 2 (Heavy Duty, minimum 18 gauge, hollow steel composite)
- Universal Hinge Prep – Allowing for an easy modification from standard to heavy weight hinge prep
- Handing Design – Square edge, non-handed

### CORES AVAILABLE FOR DP DOORS

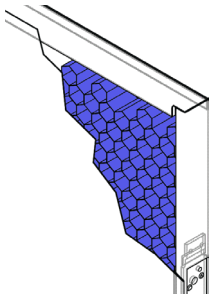

Honeycomb Core

- Efficient in 95% of all weather conditions
- STC rating 38 Inoperable Slab

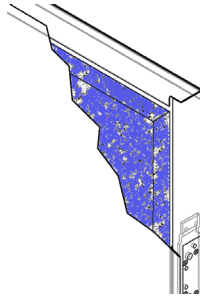

Polystyrene Core

- Efficient in extreme weather conditions
- STC rating 35 Inoperable Slab

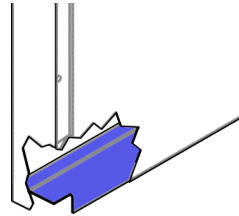

Bottom Channel

- 16 gauge steel channel (standard inverted)
- Approximate depth 9/16"

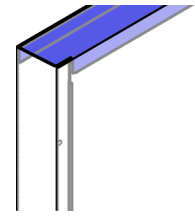

Top Channel

- 16 gauge steel channel (standard flush)
- When closer reinforcement requested 14 gauge standard

### LOCK EDGE OF PAN

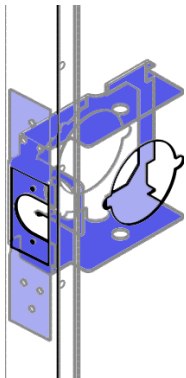

16 gauge cylindrical lock reinforcement with provisions for Gov't Series 160 or 161 cylindrical lock sets (2-3/4" backset) and ANSI A115.2 lock front

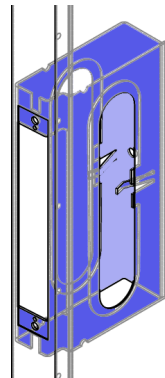

14 gauge mortise lock reinforcement with provisions for Gov't Series 86 mortise lockset and ANSI A115.1 lock front

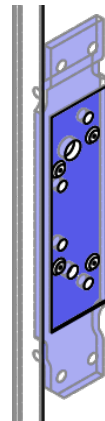

Hinge edge with 7 gauge reinforcements  
Shown: 4-1/2" hinges



DP HONEYCOMB CORE 1-3/4" THICK			
Width	Height	20 GA	18 GA
2'6" and 2'8"	6'8"	\$559	\$655
	7'0"	\$584	\$675
3'0"	6'8"	\$561	\$637
	7'0"	\$584	\$656
	8'0"	N/A	\$837
3'4" and 3'6"	6'8"	N/A	\$732
	7'0"	N/A	\$771
3'8"	6'8"	N/A	\$833
	7'0"	N/A	\$834
4'0"	6'8"	N/A	\$833
	7'0"	N/A	\$834
	8'0"	N/A	\$1,045

DP POLYSTYRENE CORE 1-3/4" THICK			
Width	Height	20 GA	18 GA
2'6" and 2'8"	6'8"	\$598	\$694
	7'0"	\$623	\$714
3'0"	6'8"	\$600	\$676
	7'0"	\$623	\$695
	8'0"	N/A	\$876
3'4" and 3'6"	6'8"	N/A	\$771
	7'0"	N/A	\$810
3'8"	6'8"	N/A	\$872
	7'0"	N/A	\$873
4'0"	6'8"	N/A	\$872
	7'0"	N/A	\$873
	8'0"	N/A	\$1,084

DP EMBOSSED 1-3/4" THICK				
Pattern	Width	Height	20	18
2-Panel HD P2	3'0"	6'8"	N/A	\$924
		7'0"	N/A	\$943
		8'0"	N/A	\$1,128
6-Panel	3'0"	6'8"	N/A	\$924
		7'0"	N/A	\$943
6-Panel (8'0")	3'0"	8'0"	N/A	\$1,128

Note: All DP Embossed are A40 galvanized.

STEEL TYPES	
Cold rolled steel	Included
A60 Galvanized steel	\$105.00

HINGE PREPARATIONS	
Special hinge locations (vertical)	No charge
4-1/2" Heavy weight hinge prep	No charge
Additional hinge prep (per hinge)	\$25.00
3/16" (7 gauge) Hinge reinforcements (per hinge)	Included

CLOSER PREPARATIONS	
Closer reinforcement - 14 GA x 18" x 6"	\$37.00

LABEL PREPARATIONS	
Mark numbers	No charge
U.L. Mylar label (standard unless specified otherwise) **LIMITATIONS**	\$20.00
U.L. Metal label **LIMITATIONS**	\$48.00
ITS/Warnock Hersey Metal label **LIMITATIONS**	\$48.00
Hurricane label (E330 only) **LIMITATIONS** (See <a href="#">Engineering</a> for details)	

SPECIAL CONSTRUCTIONS	
Special width	N/A
Special height	N/A
3/4" Undercuts	No charge
Flush bottom channel	No charge

INACTIVE LEAF PREPARATIONS	
Flush bolt embossed top/bottom channel	No charge
ANSI 4-7/8" Strike prep - requires the application of a Z astragal with tap plates	\$59.00
Attaching astragal (includes astragal)	\$110.00
Flush bolt (edge, top and bottom prep) ANSI A115.4 ▪ DP Series door requiring FB prep accommodated by the application of Z astragal with tap plates	\$95.00
Surface bolt reinforce only	\$36.00

STRIKE/LOCK PREPARATIONS	
Special lock location (vertical)	No charge
Cylindrical or Cyl-DT (Lever)	No charge
Gov't 86 Edge and panel prep	No charge
Gov't 86 Edge prep only	No charge
Cylindrical dead lock prep (min distance between 7")	\$61.00
Rim reinforcement only	\$50.00

FINISH PREPARATIONS	
Second coat of primer	\$124.00
Finish paint setup charge (never waived)	\$1,350.00
Finish paint ▪ Minimum quantity of 20 per color ▪ Price includes full carton wrap	\$274.00



## HONEYCOMB

### DL/DE Series

refer to technical data sheet on page 9

- Door Thickness – 1-3/4" (14 gauge = 1-13/16")
- Actual Door Size – Door undersized from nominal by 1/4" in width and 7/8" in height. Standard undercut is 3/4".
- Core – 3/4" Cell Honeycomb Core. STC rating of 38 (standard doors are not STC labeled. See STC doors for labeled doors)
- Hinge Rail and Reinforcement – Hinge edge is non-beveled and reinforced with a continuous 16 gauge steel channel (Optional 10 gauge - DE Series) projection welded at a maximum of 5" on center
  - Additional reinforcement plates are provided (DL Series) at the hinge locations to give a total of 3/16" reinforcement (Backset 1/4")
- Top Channel – Top channel is a flush 16 gauge steel channel, projection welded at a maximum of 2-1/2" on center
- Bottom channel – Bottom channel is an inverted 16 gauge steel channel, projection welded at a maximum of 2-1/2" on center
- Lock Rail – Lock edge is square and reinforced with a continuous 16 gauge steel channel projection welded at a maximum of 5" on center (Optional - Beveled 1/8" in 2")
  - 16 gauge reinforcements for mortise or cylindrical locks are of an integral type in accordance with ANSI A115 standards
- Face Skins – 20 gauge, 18 gauge, 16 gauge, or 14 gauge (DE Series) (cold rolled steel or A60 galvanized)
  - G90 Galvanized available in 16 or 14 gauge only
- Closer reinforcement – 14 gauge 18" x 6" (Optional 12 gauge)
- Size Availability
  - Max. 4'0" x 10'0" (Singles)
  - Max. 8'0" x 10'0" (Pairs)
- SDI 100 - Grade/Model – Levels 1-4 and Models 1 and 2 (Maximum Duty Performance level A)
- Label Range – 20 minute through 3 hour / Underwriters Laboratory or ITS/Warnock Hersey
- Edge Seam Construction – Visible seam is standard. Continuously welded seamless or intermittently welded seamless available. (Options)
- Universal Standard/Heavy Weight Hinge – Hinge fillers are used allowing for easy modification from heavy to standard weight hinge prep
- Handing Design – Non-handed standard (Optional handed)

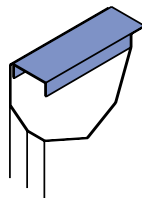
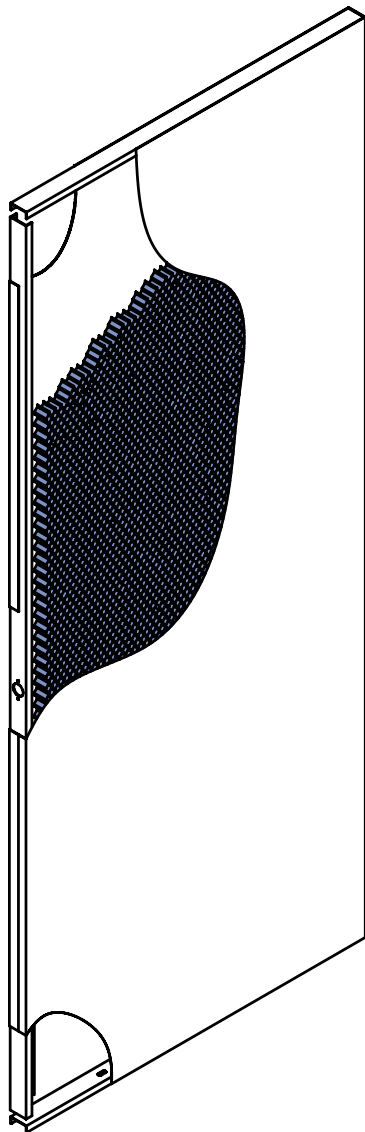

Flush Top

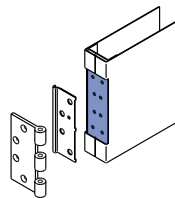

Door Hinge Prep



Paired doors without astragal

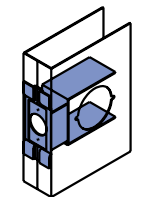

Cylindrical Lock Prep

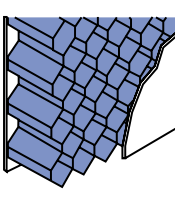

Honeycomb Core



Paired doors with flat bar astragal



Paired doors with "Z" astragal

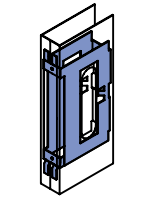

Mortise Lock Prep

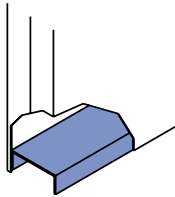

Inverted Bottom Channel



F



V



N



G



FG



LI



D

DP SERIES

HONEYCOMB

INSULATED

STEEL STIFFENED

EMBOSSED

SDI CLASSIFICATIONS				
Grade		Model	Construction	Republic Series
I	Physical Performance Level C 1-3/4" (44) and 1-3/8" (35) Standard Duty Minimum Gauge = 20	1	Full Flush	DL 420
		2	Seamless (Unavailable)	DL 420
II	Physical Performance Level B 1-3/4" (44) Only Heavy Duty Minimum Gauge = 18	1	Full Flush	DL 418, DE 418
		2	Seamless	DL 418, DE 418
III	Physical Performance Level A 1-3/4" (44) Only Extra-Heavy Duty Minimum Gauge = 16	1	Full Flush	DL 416, DE 416
		2	Seamless	DL 416, DE 416
IV	Physical Performance Level A 1-3/4" (44) Only Extra-Heavy Duty Minimum Gauge = 14	1	Full Flush	DE 414
		2	Seamless	DE 414

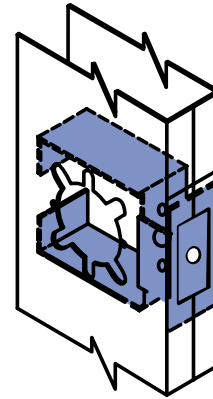

Universal Lock Prep "DT"

HONEYCOMB DOOR 1-3/4" THICK					
Width	Height	20 GA	18 GA	16 GA	14 GA
1'6" – 2'8"	6'8"	\$770	\$860	\$1,058	\$1,445
	7'0"	\$796	\$892	\$1,094	\$1,558
	7'2"	N/A	\$968	\$1,127	\$1,559
	8'0"	N/A	\$1,199	\$1,393	\$1,939
	9'0"	N/A	\$1,576	\$1,715	\$2,353
	10'0"	N/A	\$1,762	\$1,988	\$2,405
Over 2'8" – 3'0"	6'8"	\$804	\$868	\$1,075	\$1,457
	7'0"	\$820	\$898	\$1,076	\$1,505
	7'2"	N/A	\$994	\$1,165	\$1,581
	8'0"	N/A	\$1,231	\$1,436	\$1,958
	9'0"	N/A	\$1,576	\$1,715	\$2,353
	10'0"	N/A	\$1,762	\$1,988	\$2,405
Over 3'0" – 3'6"	6'8"	N/A	\$1,043	\$1,241	\$1,636
	7'0"	N/A	\$1,087	\$1,281	\$1,656
	7'2"	N/A	\$1,117	\$1,321	\$1,717
	8'0"	N/A	\$1,377	\$1,570	\$2,115
	9'0"	N/A	\$1,752	\$1,978	\$2,367
	10'0"	N/A	\$1,941	\$2,219	\$2,589
Over 3'6" – 4'0"	6'8"	N/A	\$1,149	\$1,344	\$1,725
	7'0"	N/A	\$1,199	\$1,381	\$1,787
	7'2"	N/A	\$1,264	\$1,485	\$1,850
	8'0"	N/A	\$1,485	\$1,656	\$2,205
	9'0"	N/A	\$1,862	\$2,167	\$2,472
	10'0"	N/A	\$1,941	\$2,219	\$2,589

STEEL TYPES	
Cold rolled steel	Included
A60 Galvanized steel	\$105.00
G90 Galvanized steel (available in 14 and 16 gauge only)	\$419.00

HINGE PREPARATIONS	
Special hinge locations	No charge
4-1/2" or 5" Universal hinge prep	No charge
Additional hinge prep (per hinge)	\$25.00
Electric hinge <ul style="list-style-type: none"> <li>Cutout in one hinge reinf., no conduit, no wiring</li> </ul>	\$25.00
Surface mounted hinges (reinforced only)	\$114.00
Continuous hinge reinforcement	\$88.00
Special backset (per hinge)	\$131.00
Power transfer <ul style="list-style-type: none"> <li>No junction box or conduit</li> <li>Cutout with reinforcement/tap plate(s)</li> </ul>	\$131.00

CLOSER PREPARATIONS	
Closer reinforcement	\$37.00
Concealed overhead door closer, holder or stop	\$371.00
Allegion Concealed overhead door closer, holder or stop	\$323.00

SPECIAL FINISH PREPARATIONS	
Second coat of primer	\$124.00
Finish paint setup charge (never waived)	\$1,350.00
Finish paint <ul style="list-style-type: none"> <li>Minimum quantity of 20 per color</li> <li>Price includes full carton wrap</li> </ul>	\$274.00

DP SERIES

HONEYCOMB

INSULATED

STEEL STIFFENED

EMBOSSED

LOCK PREPARATIONS	
Special lock location	No charge
Special lock backset up to 5"	No charge
Sectional trim prep (mortise lock with function holes)	\$56.00
Cylindrical dead lock	\$61.00
Mortise dead lock	\$61.00
Rim reinforcement only	\$50.00
Rim reinforcement with function prep	\$56.00
Mortise exit device reinforcement only	\$37.00
Mortise exit device reinforcement with function prep	\$89.00
Allegion Mortise exit device reinforcement with function prep	\$71.00
Surface vertical rod reinforcement only	\$82.00
Surface vertical rod reinforcement with function prep	\$99.00
Allegion Surface vertical rod reinforcement with function prep	\$87.00
Concealed vertical rod	\$611.00
Allegion Concealed vertical rod	\$476.00
▪ Frame mortise strike (per prep)	
▪ Door per template	
Exit alarm reinforcement only	\$62.00
Inset exit device (14 and 16 gauge doors only)	\$476.00
Push pull reinforcement	\$40.00

SPECIAL CONSTRUCTIONS	
Undercut - less than 3/8" price as next larger door height	No charge
Inverted top channel	No charge
Flush bottom channel	No charge
Dutch door (4) 4.5" hinge preps x (1) 161 lock prep	\$92.00
Unifit (retrofit) hinge channel	\$89.00
Seal top or bottom channel and finish smooth each	\$142.00
Mag switch/DPS - Hole only	\$23.00
Mag switch/DPS - Prep and reinf.	\$123.00
Bondo filled edge	\$115.00
Continuous welded edge (N/A in 20 gauge)	\$169.00
Beveled lock edge (1/8" in 2") N/A in 14 gauge and Inactive leaves with strike(s)	\$23.00
10 Gauge hinge and 14 gauge lock channels DE Series (standard on 14 gauge door)	\$156.00
1-3/8" Thick door - DE Series (See <a href="#">Engineering</a> for details)	\$156.00
Door viewer	\$30.00
Mail slot	\$85.00
Automatic door bottom (mortise type)	\$225.00
Conduit/raceway - includes wire pull	\$190.00

LABEL PREPARATIONS	
Mark numbers	No charge
U.L. Mylar label (standard unless specified otherwise)	\$20.00
U.L. Metal label	\$48.00
ITS/Warnock Hersey Metal label	\$48.00
Hurricane label (See <a href="#">Engineering</a> for details)	\$20.00

INACTIVE LEAF PREPARATIONS	
Flush bolt embossed top/bottom channel	No charge
Cylindrical (2-3/4") or mortise (3-1/2") dead lock strike	\$61.00
Electric strike (no conduit)	\$135.00
ASA Strike only	\$59.00
Attaching astragal (includes astragal)	\$110.00
Flush bolt prep (ANSI 115.4)	\$95.00
Surface bolt reinforce only	\$36.00
Open back strike	\$161.00

GLASS KIT OPTIONS			
	Vision/ Narrow Lite up to 100 inch <sup>2</sup>	Half Glass over 100 inch <sup>2</sup> up to 800 inch <sup>2</sup>	Full Glass over 800 inch <sup>2</sup>
Cutout with kit installed	\$231	\$274	N/A
Cutout with kit and reinf.	\$313	\$356	\$389
Sunburst kit (1/2" glass included)	\$560	N/A	N/A
Muntin bar (each)	\$150	\$150	\$150
Galvanized kit add	\$127	\$127	\$127
Glass pocket add (other than 1/4" )	\$209	\$209	\$209

Note: Prices are based on Republic standard lite kit. (No glass unless noted otherwise.)

CUTOUT ONLY OPTIONS (GLASS KITS AND LOUVERS)			
	Up to 100 inch <sup>2</sup>	Over 100 inch <sup>2</sup> up to 800 inch <sup>2</sup>	Over 800 inch <sup>2</sup>
Panel in place	\$85	\$85	N/A
Cutout only	\$85	\$85	N/A
Cutout with reinforcement	\$167	\$167	\$167
Round cutout only (no reinf)	\$325	\$325	N/A

LOUVER OPTIONS		
Description	Size	Price
Louver installed no reinf	12" x 12"	\$400.00
Louver installed no reinf	18" x 12"	\$453.00
Louver installed no reinf	24" x 12"	\$535.00
Louver installed no reinf	24" x 18"	\$603.00
Louver installed no reinf	24" x 24"	\$734.00
Louver installed no reinf	24" x 60"	\$1,524.00
Galvanized louver add	-	\$54.00
Fusible link louver add	-	\$402.00

Note: Prices are based on Republic standard louver.

See [Engineering Section](#) for further options and/or details.

## INSULATED

### DL/DE Series

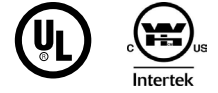

refer to technical data sheet on page 9

- Door Thickness – 1-3/4" (14 gauge = 1-13/16")
- Actual Door Size – Door undersized from nominal by 1/4" in width and 7/8" in height. Standard undercut is 3/4".
- Core - 1 lb. density Polystyrene (standard)/ Optional 2 lb. Polyurethane core
- Polystyrene Core
  - "U" Factor = 0.41/STC = 35
  - "R" Factor = 2.43 (per ASTM C1363)
- Polyurethane Core
  - "U" Factor = 0.39/STC = 33
  - "R" Factor = 2.56 (per ASTM C1363)
- Hinge Rail and Reinforcement – Hinge edge is non-beveled and reinforced with a continuous 16 gauge steel channel (Optional 10 gauge - DE Series) projection welded at a maximum of 5" on center
  - Additional reinforcement plates are provided (DL Series) at the hinge locations to give a total of 3/16" reinforcement (Backset 1/4")
- Lock Rail – Lock edge is non-beveled and reinforced with a continuous 16 gauge steel channel projection welded at a maximum of 5" on center (Optional - Beveled 1/8" in 2" )
  - 16 gauge reinforcements for mortise or cylindrical locks are of an integral type in accordance with ANSI A115 standards
- Top Channel – Top channel is a flush 16 gauge steel channel, projection welded at a maximum of 2-1/2" on center
- Bottom channel – Bottom channel is an inverted 16 gauge steel channel, projection welded at a maximum of 2-1/2" on center
- Face Skins – 20 gauge (DL Series), 18 gauge, 16 gauge or 14 gauge (DE Series) (cold rolled steel or A60 galvanized)
  - \* G90 Galvanized available in 16 or 14 gauge only
- Closer reinforcement – 14 gauge 18" x 6" (Optional 12 gauge)
- Size Availability
  - Max. 4'0" x 10'0" (Singles)
  - Max. 8'0" x 10'0" (Pairs)
- SDI 100 - Grade/Model – Levels 1-4 and Models 1 and 2 (Maximum Duty Performance level A)
- Label Range – 20 minute through 3 hour/ Underwriters Laboratory or ITS/Warnock Hersey (Not available in urethane)
- Edge Seam Construction – Visible seam is standard. Continuously welded or intermittently welded seamless available (Options)
- Universal Standard/Heavy Weight Hinge – Hinge fillers are used allowing for easy modification from standard to heavy weight hinge prep
- Handing Design – Non-handed standard (Optional handed)

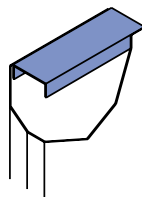
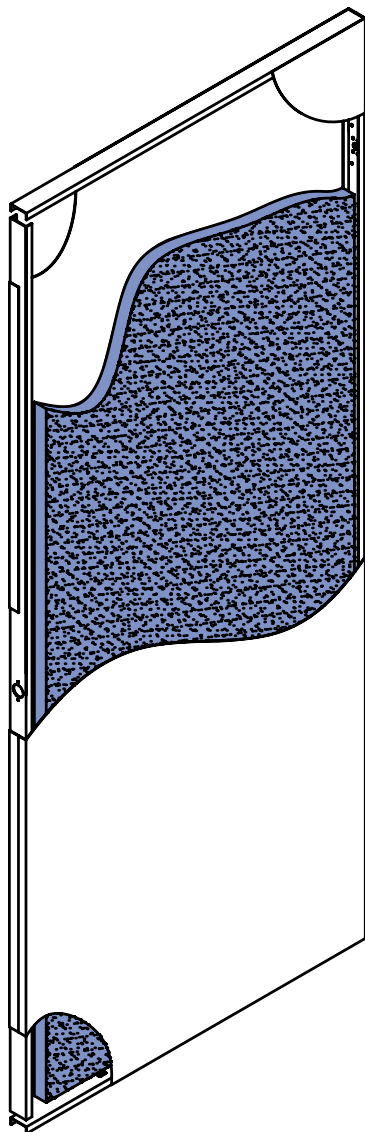

Flush Top

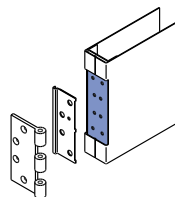

Door Hinge Prep

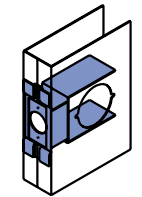

Cylindrical Lock Prep

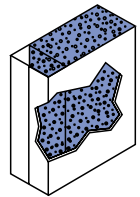

Insulated Core

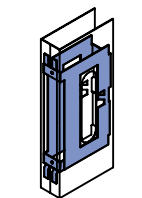

Mortise Lock Prep

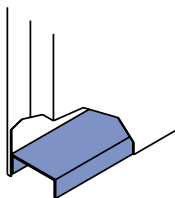

Inverted Bottom Channel

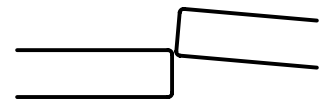

Paired doors without astragal



Paired doors with flat bar astragal



Paired doors with "Z" astragal



F



V



N



G



FG



LI



D

DP SERIES

HONEYCOMB

INSULATED

STEEL STIFFENED

EMBOSSED

SDI CLASSIFICATIONS				
Grade		Model	Construction	Republic Series
I	Physical Performance Level C 1-3/4" (44) and 1-3/8" (35) Standard Duty Minimum Gauge = 20	1	Full Flush	DL 420
		2	Seamless (Unavailable)	DL 420
II	Physical Performance Level B 1-3/4" (44) Only Heavy Duty Minimum Gauge = 18	1	Full Flush	DL 418, DE 418
		2	Seamless	DL 418, DE 418
III	Physical Performance Level A 1-3/4" (44) Only Extra-Heavy Duty Minimum Gauge = 16	1	Full Flush	DL 416, DE 416
		2	Seamless	DL 416, DE 416
IV	Physical Performance Level A 1-3/4" (44) Only Extra-Heavy Duty Minimum Gauge = 14	1	Full Flush	DE 414
		2	Seamless	DE 414

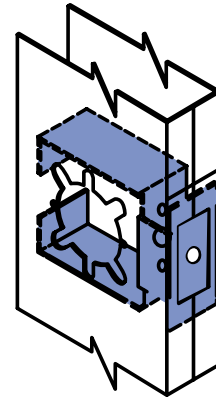

Universal Lock Prep  
"DT"

POLYSTYRENE DOOR 1-3/4" THICK					
Width	Height	20 GA	18 GA	16 GA	14 GA
1'6" – 2'8"	6'8"	\$809	\$899	\$1,097	\$1,484
	7'0"	\$835	\$931	\$1,133	\$1,597
	7'2"	N/A	\$1,007	\$1,166	\$1,598
	8'0"	N/A	\$1,238	\$1,432	\$1,978
	9'0"	N/A	\$1,615	\$1,754	\$2,392
	10'0"	N/A	\$1,801	\$2,027	\$2,444
Over 2'8" – 3'0"	6'8"	\$843	\$907	\$1,114	\$1,496
	7'0"	\$859	\$937	\$1,115	\$1,544
	7'2"	N/A	\$1,033	\$1,204	\$1,620
	8'0"	N/A	\$1,270	\$1,475	\$1,997
	9'0"	N/A	\$1,615	\$1,754	\$2,392
	10'0"	N/A	\$1,801	\$2,027	\$2,444
Over 3'0" – 3'6"	6'8"	N/A	\$1,082	\$1,280	\$1,675
	7'0"	N/A	\$1,126	\$1,320	\$1,695
	7'2"	N/A	\$1,156	\$1,360	\$1,756
	8'0"	N/A	\$1,416	\$1,609	\$2,154
	9'0"	N/A	\$1,791	\$2,017	\$2,406
	10'0"	N/A	\$1,980	\$2,258	\$2,628
Over 3'6" – 4'0"	6'8"	N/A	\$1,188	\$1,383	\$1,764
	7'0"	N/A	\$1,238	\$1,420	\$1,826
	7'2"	N/A	\$1,303	\$1,524	\$1,889
	8'0"	N/A	\$1,524	\$1,695	\$2,244
	9'0"	N/A	\$1,901	\$2,206	\$2,511
10'0"	N/A	\$1,980	\$2,258	\$2,628	

INSULATED CORES	
Polystyrene	Included
Polyurethane (N/A for fire rated)	\$194.00
Temperature rise (250° mineral fiberboard)	\$1,005.00

STEEL TYPES	
Cold rolled steel	Included
A60 Galvanized steel	\$105.00
G90 Galvanized steel (available in 14 and 16 gauge only)	\$419.00

HINGE PREPARATIONS	
Special hinge locations	No charge
4-1/2" or 5" Universal hinge prep	No charge
Additional hinge prep (per hinge)	\$25.00
Electric hinge	\$25.00
▪ Cutout in one hinge reinf., no wiring included, no conduit	
Surface mounted hinges (reinforced only)	\$114.00
Continuous hinge reinforcement	\$88.00
Special backset (per hinge)	\$131.00
Power transfer	\$131.00
▪ No junction box or conduit	
▪ Cutout with reinforcement/tap plate(s)	

CLOSER PREPARATIONS	
Closer reinforcement	\$37.00
Concealed overhead door closer, holder or stop	\$371.00
Allegion Concealed overhead door closer, holder or stop	\$323.00

LOCK PREPARATIONS	
Special lock location	No charge
Special lock backset up to 5"	No charge
Sectional trim prep (mortise lock with function holes)	\$56.00
Cylindrical dead lock	\$61.00
Mortise dead lock	\$61.00
Rim reinforcement only	\$50.00
Rim reinforcement with function prep	\$56.00
Mortise exit device reinforcement only	\$37.00
Mortise exit device reinforcement with function prep	\$89.00
Allegion Mortise exit device reinforcement with function prep	\$71.00
Surface vertical rod reinforcement only	\$82.00
Surface vertical rod reinforcement with function prep	\$99.00
Allegion Surface vertical rod reinforcement with function prep	\$87.00
Concealed vertical rod	\$611.00
Allegion Concealed vertical rod	\$476.00
▪ Frame mortise strike (per prep)	
▪ Door per template	
Exit alarm reinforcement only	\$62.00
Inset exit device (14 and 16 gauge doors only)	\$476.00
Push pull reinforcement	\$40.00

LABEL PREPARATIONS	
Mark numbers	No charge
U.L. Mylar label (standard unless specified otherwise)	\$20.00
U.L. Metal label	\$48.00
ITS/Warnock Hersey Metal label	\$48.00
Hurricane label (See <a href="#">Engineering</a> for details)	\$20.00

SPECIAL CONSTRUCTIONS	
Undercut - under 3/8" price next larger size	No charge
Inverted top channel	No charge
Flush bottom channel	No charge
Dutch door (4) 4.5" hinge preps x (1) 161 lock prep	\$92.00
Unifit hinge channel	\$89.00
Seal top or bottom channel and finish smooth each	\$142.00
Mag switch/DPS - Hole only	\$23.00
Mag switch/DPS - Prep and reinf.	\$123.00
Bondo filled edge	\$115.00
Continuous welded edge (N/A in 20 gauge)	\$169.00
Beveled lock edge (1/8" in 2") N/A in 14 gauge and Inactive leafs with strike(s)	\$23.00
10 Gauge hinge and 14 gauge lock channels DE Series (standard on 14 gauge door)	\$156.00
1-3/8" Thick door - DE Series (See <a href="#">Engineering</a> for details)	\$156.00
Door viewer	\$30.00
Mail slot	\$85.00
Automatic door bottom (mortise type)	\$225.00
Conduit/raceway - includes wire pull	\$190.00

See [Engineering Section](#) for further options and/or details.

INACTIVE LEAF PREPARATIONS	
Flush bolt embossed top/bottom channel	No charge
Cylindrical (2-3/4") or mortise (3-1/2") dead lock strike	\$61.00
Electric strike (no conduit)	\$135.00
ASA Strike only	\$59.00
Attaching astragal (includes astragal)	\$110.00
Flush bolt prep (ANSI 115.4)	\$95.00
Surface bolt reinforce only	\$36.00
Open back strike	\$161.00

SPECIAL FINISH PREPARATIONS	
Second coat of primer	\$124.00
Finish paint setup charge (never waived)	\$1,350.00
Finish paint	\$274.00
▪ Minimum quantity of 20 per color	
▪ Price includes full carton wrap	

GLASS KIT OPTIONS			
	Vision/ Narrow Lite up to 100 inch <sup>2</sup>	Half Glass over 100 inch <sup>2</sup> up to 800 inch <sup>2</sup>	Full Glass over 800 inch <sup>2</sup>
Cutout with kit installed	\$231	\$274	N/A
Cutout with kit and reinf.	\$313	\$356	\$389
Sunburst kit (1/2" glass included)	\$560	N/A	N/A
Muntin bar (each)	\$150	\$150	\$150
Galvanized kit add	\$127	\$127	\$127
Glass pocket add (other than 1/4")	\$209	\$209	\$209

Note: Prices are based on Republic standard lite kit. (No glass unless noted otherwise.)

CUTOUT ONLY OPTIONS			
	Up to 100 inch <sup>2</sup>	Over 100 inch <sup>2</sup> up to 800 inch <sup>2</sup>	Over 800 inch <sup>2</sup>
Panel in place	\$85	\$85	N/A
Cutout only	\$85	\$85	N/A
Cutout with reinforcement	\$167	\$167	\$167
Round cutout only (no reinf)	\$325	\$325	N/A

LOUVER OPTIONS		
Description	Size	Price
Louver installed no reinf	12" x 12"	\$400.00
Louver installed no reinf	18" x 12"	\$453.00
Louver installed no reinf	24" x 12"	\$535.00
Louver installed no reinf	24" x 18"	\$603.00
Louver installed no reinf	24" x 24"	\$734.00
Louver installed no reinf	24" x 60"	\$1,524.00
Galvanized louver add	-	\$54.00
Fusible link louver add	-	\$402.00

Note: Prices are based on Republic standard louver.



## STEEL STIFFENED

### DL/DE Series

refer to technical data sheet on page 9

- Door Thickness – 1-3/4" (14 gauge = 1-13/16")
- Actual Door Size – Door undersized from nominal by 1/4" in width and 7/8" in height. Standard undercut is 3/4".
- Core – Fiberglass batting between each stiffener
  - "U" Factor = 0.61
  - "R" Factor = 1.65
  - (Optional) Polystyrene or polyurethane between stiffeners
- Hinge Rail and Reinforcement – Hinge edge is non-beveled and reinforced with a continuous 16 gauge steel channel projection welded at a maximum of 5" on center. (Optional 10 gauge)
- Lock Rail – Lock edge is non-beveled and reinforced with a continuous 16 gauge steel channel projection welded at a maximum of 5" on center. (Optional 14 gauge) (Beveled 1/8" in 2" optional)
- Top Channel – Top channel is a flush 16 gauge steel channel, projection welded at a maximum of 2-1/2" on center
- Bottom Channel – Bottom channel is an inverted 16 gauge steel channel, projection welded at a maximum of 2-1/2" on center
- Face Skins – 18 gauge, 16 gauge, or 14 gauge (cold rolled steel or A60 galvanized)
  - \* G90 Galvanized available in 16 or 14 gauge only
- Stiffener Gauge – 20 gauge (Optional 18 or 16 gauge)
- Stiffener Spacing – 6" maximum apart (Varies according to door width)
- Stiffener Welding – 5" maximum on center (Vertically)
- Closer Reinforcement – 14 gauge 18" x 6" (Optional 12 gauge)
- Size Availability
  - Max. 4'10" x 10'0" (Singles)
  - Max. 9'8" x 10'0" (Pairs) (max. 18 ga – 4'0" x 8'0")
- SDI 100 - Grade/Model – Levels 2-4 and Models 1 and 2 (Maximum Duty Performance level A)
- Label Range – 20 minute through 3 hour/ Underwriters Laboratory or ITS/Warnock Hersey (Not available in urethane)
- Edge Seam Construction – Visible seam (standard), continuously welded seamless or intermittently welded seamless available
- Universal Standard/Heavy Weight Hinge – Hinge fillers are used allowing for easy modification from standard to heavy weight hinge prep
- Handing Design – Non-handed standard (Optional handed)

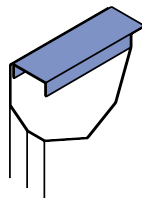
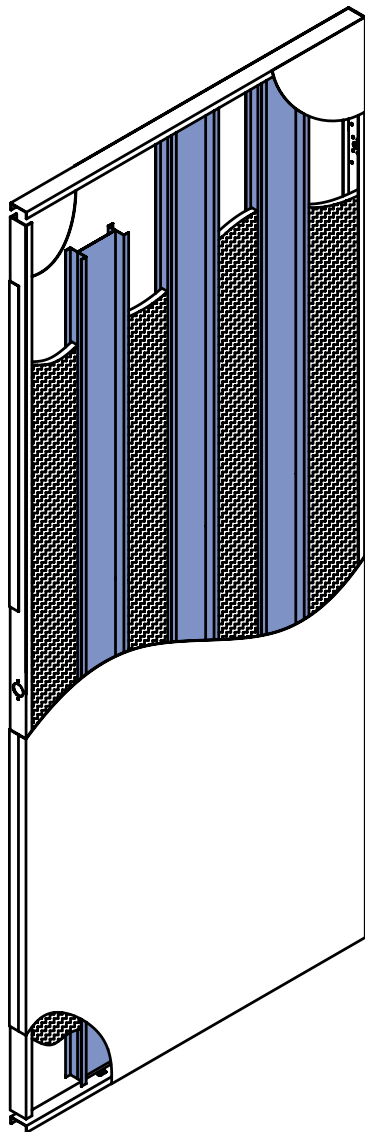

Flush Top

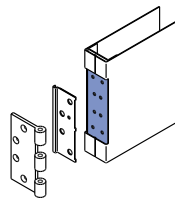

Door Hinge Prep

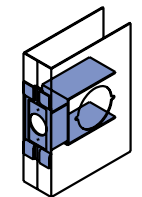

Cylindrical Lock Prep

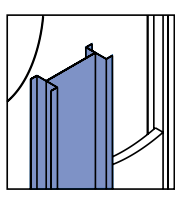

Steel Stiffened Core

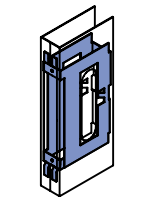

Mortise Lock Prep

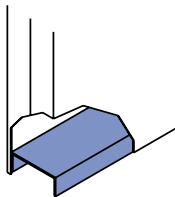

Inverted Bottom Channel

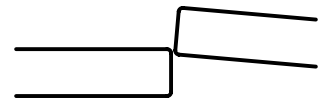

Paired doors without astragal



Paired doors with flat bar astragal



Paired doors with "Z" astragal



F



V



N



G



LI



D

DP SERIES

HONEYCOMB

INSULATED

STEEL STIFFENED

EMBOSSED



SDI CLASSIFICATIONS				
Grade		Model	Construction	Republic Series
II	Physical Performance Level B 1-3/4" (44) Only Heavy Duty Minimum Gauge = 18	1	Full Flush	DL 418, DE 418
		2	Seamless	DL 418, DE 418
III	Physical Performance Level A 1-3/4" (44) Only Extra-Heavy Duty Minimum Gauge = 16	1	Full Flush	DL 416, DE 416
		2	Seamless	DL 416, DE 416
IV	Physical Performance Level A 1-3/4" (44) Only Extra-Heavy Duty Minimum Gauge = 14	1	Full Flush	DE 414
		2	Seamless	DE 414

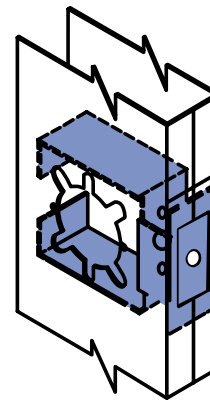

Universal Lock Prep  
"DT"

STEEL STIFFENED DOOR 1-3/4" THICK					
Width	Height	20 GA	18 GA	16 GA	14 GA
1'6" – 2'8"	6'8"	N/A	\$1,097	\$1,273	\$1,707
	7'0"	N/A	\$1,139	\$1,317	\$1,778
	7'2"	N/A	\$1,195	\$1,348	\$1,799
	8'0"	N/A	\$1,484	\$1,651	\$2,118
	9'0"	N/A	\$1,845	\$2,075	\$2,570
	10'0"	N/A	\$1,949	\$2,200	\$2,642
Over 2'8" – 3'0"	6'8"	N/A	\$1,110	\$1,338	\$1,714
	7'0"	N/A	\$1,149	\$1,350	\$1,785
	7'2"	N/A	\$1,227	\$1,399	\$1,811
	8'0"	N/A	\$1,484	\$1,651	\$2,118
	9'0"	N/A	\$1,845	\$2,075	\$2,570
	10'0"	N/A	\$1,949	\$2,200	\$2,642
Over 3'0" – 3'6"	6'8"	N/A	\$1,303	\$1,477	\$1,870
	7'0"	N/A	\$1,344	\$1,520	\$1,934
	7'2"	N/A	\$1,370	\$1,535	\$2,004
	8'0"	N/A	\$1,632	\$1,822	\$2,248
	9'0"	N/A	\$1,986	\$2,237	\$2,708
	10'0"	N/A	\$2,138	\$2,244	\$2,884
Over 3'6" – 4'0"	6'8"	N/A	\$1,420	\$1,557	\$1,981
	7'0"	N/A	\$1,439	\$1,590	\$2,037
	7'2"	N/A	\$1,443	\$1,648	\$2,117
	8'0"	N/A	\$1,771	\$1,912	\$2,364
	9'0"	N/A	\$2,020	\$2,323	\$2,830
	10'0"	N/A	\$2,195	\$2,343	\$3,071
Over 4'0" – 4'10"	6'8"	N/A	N/A	\$3,993	\$5,043
	7'0"	N/A	N/A	\$4,201	\$5,147
	7'2"	N/A	N/A	\$4,296	\$5,276
	8'0"	N/A	N/A	\$4,464	\$5,468
	9'0"	N/A	N/A	\$4,657	\$5,659
	10'0"	N/A	N/A	\$4,743	\$5,746

14/16 Gauge doors over 4'0 available in Galv only.

CORES	
20 Gauge stiffeners	Included
18 Gauge stiffeners	\$375.00
16 Gauge stiffeners	\$526.00
Polystyrene between stiffeners	\$39.00
Polyurethane between stiffeners (N/A as fire rated)	\$352.00

STEEL TYPES	
Cold rolled steel	Included
A60 Galvanized steel	\$105.00
G90 Galvanized steel (available in 14 and 16 gauge only); N/A in 14 gauge doors over 4'0" wide)	\$419.00

HINGE PREPARATIONS	
Special hinge locations	No charge
4-1/2" or 5" Universal hinge prep	No charge
Additional hinge prep (per hinge)	\$25.00
Electric hinge <ul style="list-style-type: none"> <li>▪ Cutout in one hinge reinf.</li> <li>▪ No wiring included, no conduit</li> </ul>	\$25.00
Surface mounted hinges (reinforced only)	\$114.00
Continuous hinge reinforcement	\$88.00
Special backset (per hinge)	\$131.00
Power transfer (no conduit)	\$131.00

CLOSER PREPARATIONS	
Closer reinforcement	\$37.00
Concealed overhead door closer, holder or stop	\$371.00
Allegion Concealed overhead door closer, holder or stop	\$323.00

DP SERIES

HONEYCOMB

INSULATED

STEEL STIFFENED

EMBOSSED

LOCK PREPARATIONS	
Special lock location	No charge
Special lock backset up to 5"	No charge
Sectional trim prep (mortise lock with function holes)	\$56.00
Cylindrical dead lock	\$61.00
Mortise dead lock	\$61.00
Rim reinforcement only	\$50.00
Rim reinforcement with function prep	\$56.00
Mortise exit device reinforcement only	\$37.00
Mortise exit device reinforcement with function prep	\$89.00
Allegion Mortise exit device reinforcement with function prep	\$71.00
Surface vertical rod reinforcement only	\$82.00
Surface vertical rod reinforcement with function prep	\$99.00
Allegion Surface vertical rod reinforcement with function prep	\$87.00
Concealed vertical rod	\$611.00
Allegion Concealed vertical rod	\$476.00
<ul style="list-style-type: none"> <li>Frame mortise strike (per prep)</li> <li>Door per template</li> </ul>	
Exit alarm reinforcement only	\$62.00
Inset exit device (14 and 16 gauge doors only)	\$476.00
Push pull reinforcement	\$40.00

LABEL PREPARATIONS	
Mark numbers	No charge
U.L. Mylar label (standard unless specified otherwise)	\$20.00
U.L. Metal label	\$48.00
ITS/Warnock Hersey Metal label	\$48.00
Hurricane label (See <a href="#">Engineering</a> for details)	\$20.00

Note: Polyurethane unavailable as fire rated.

SPECIAL CONSTRUCTIONS	
Undercut - under 3/8" price next larger size	No charge
Inverted top channel	No charge
Flush bottom channel	No charge
Dutch door (4) 4.5" hinge preps x (1) 161 lock prep	\$92.00
Unifit hinge channel	\$89.00
Seal top or bottom channel and finish smooth each	\$142.00
Mag switch/DPS - Hole only	\$23.00
Mag switch/DPS - Prep and reinf.	\$123.00
Continuous welded edge (N/A in 20 gauge)	\$169.00
Bondo filled edge	\$115.00
Beveled lock edge (1/8" in 2") N/A in 14 gauge	\$23.00
10 Gauge hinge and 14 gauge lock channels DE Series (standard on 14 gauge door)	\$156.00
1-3/8" Thick door DE (See <a href="#">Engineering</a> for details)	\$156.00
Door viewer	\$30.00
Mail slot	\$85.00
Automatic door bottom (mortise type)	\$225.00
Conduit/raceway - includes wire pull	\$190.00

See [Engineering Section](#) for further options and/or details.

INACTIVE LEAF PREPARATIONS	
Flush bolt embossed top/bottom channel	No charge
Cylindrical (2-3/4") or mortise (3-1/2") dead lock strike	\$61.00
Electric strike (no conduit)	\$135.00
ASA Strike only	\$59.00
Attaching astragal (includes astragal)	\$110.00
Flush bolt prep (ANSI 115.4)	\$95.00
Surface bolt reinforce only	\$36.00
Open back strike	\$161.00

SPECIAL FINISH PREPARATIONS	
Second coat of primer	\$124.00
Finish paint setup charge (never waived)	\$1,350.00
Finish paint	\$274.00
<ul style="list-style-type: none"> <li>Minimum quantity of 20 per color</li> <li>Price includes full carton wrap</li> </ul>	

GLASS KIT OPTIONS			
	Vision/ Narrow Lite up to 100 inch <sup>2</sup>	Half Glass over 100 inch <sup>2</sup> up to 800 inch <sup>2</sup>	Full Glass over 800 inch <sup>2</sup>
Cutout with kit installed	\$231	\$274	N/A
Cutout with kit and reinf.	\$313	\$356	\$389
Sunburst kit (1/2" glass included)	\$560	N/A	N/A
Muntin bar (each)	\$150	\$150	\$150
Galvanized kit add	\$127	\$127	\$127
Glass pocket add (other than 1/4")	\$209	\$209	\$209

Note: Prices are based on Republic standard lite kit. (No glass unless noted otherwise.)

CUTOUT ONLY OPTIONS (GLASS KITS AND LOUVERS)			
	Up to 100 inch <sup>2</sup>	Over 100 inch <sup>2</sup> up to 800 inch <sup>2</sup>	Over 800 inch <sup>2</sup>
Panel in place	N/A	N/A	N/A
Cutout only	N/A	N/A	N/A
Cutout with reinforcement	\$167	\$167	\$167
Round cutout only (no reinf)	N/A	N/A	N/A

LOUVER OPTIONS		
Description	Size	Price
Louver installed no reinf	12" x 12"	\$400.00
Louver installed no reinf	18" x 12"	\$453.00
Louver installed no reinf	24" x 12"	\$535.00
Louver installed no reinf	24" x 18"	\$603.00
Louver installed no reinf	24" x 24"	\$734.00
Louver installed no reinf	24" x 60"	\$1,524.00
Galvanized louver add	-	\$54.00
Fusible link louver add	-	\$402.00

Note: Prices are based on Republic standard louver.

## EMBOSSED

### DL/DE Series



refer to technical data sheet on page 9

- Door Thickness – 1-3/4" (1-3/8" available in 6-Panel only)
- Actual Door Size – Door undersized from nominal by 1/4" in width and 7/8" in height. Standard undercut is 3/4".
- Core – 1 to 1.25 lb. density Polystyrene (standard)
- Hinge Rail and Reinforcement – Hinge edge is non-beveled and reinforced with a continuous 16 gauge steel channel (Optional 10 gauge - DE Series) projection welded at a maximum of 5" on center
  - Additional reinforcement plates are provided at the hinge locations to give a total of 3/16" reinforcement (Backset 1/4")
- Lock Rail – Lock edge is non-beveled and reinforced with a continuous 16 gauge steel channel projection welded at a maximum of 5" on center (Optional - Beveled 1/8" in 2")
  - 16 gauge reinforcements for mortise or cylindrical locks are of an integral type in accordance with ANSI A115 standards
- Top Channel – Top channel is a flush 16 gauge steel channel, projection welded at a maximum of 2-1/2" on center
- Bottom Channel – Bottom channel is an inverted 16 gauge steel channel, projection welded at a maximum of 2-1/2" on center
- Face Skins – 20, 18 or 16 - Faces shall be deep drawn embossed raised panels, both inside and out (16 gauge only available in 6-panel)
- Closer Reinforcement – 14 gauge 18" x 6" (Optional 12 gauge)
- Size Availability
  - Minimum 2'6" x 6'8"
  - Maximum 3'6" x 8'0" (maximum 20 gauge = 3'0" x 7'0")
  - (Optional - 3'0" x 8'0", 6-Panel design with elongated panel embossments)
- SDI 100 - Grade/Model – Levels 1-3 and Models 1 and 2 (Maximum Duty Performance level A)
- Label Range – 20 minute through 3 hour/ Underwriters Laboratory or ITS/Warnock Hersey
- Edge Seam Construction – Visible seam is standard. (Optional) Continuously welded seamless or intermittently welded seamless available (Not available in 20 gauge)
- Universal Standard/Heavy Weight Hinge – Hinge fillers are used allowing for easy modification from standard to heavy weight hinge prep
- Handing Design – Non-handed standard (Optional handed)

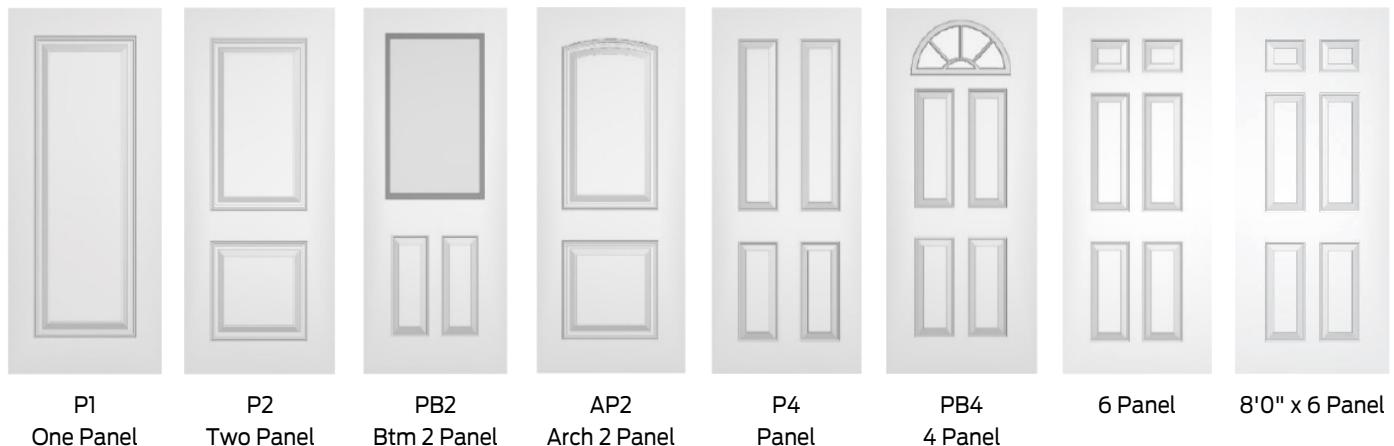

SDI CLASSIFICATIONS				
Grade		Model	Construction	Republic Series
I	Physical Performance Level C 1-3/4" (44) and 1-3/8" (35) Standard Duty Minimum Gauge = 20	1	Full Flush (Not applicable)	DL 420
		2	Seamless (Unavailable)	DL 420
II	Physical Performance Level B 1-3/4" (44) Only Heavy Duty Minimum Gauge = 18	1	Full Flush (Not applicable)	DL 418, DE418
		2	Seamless	DL 418, DE418
III	Physical Performance Level A 1-3/4" (44) Only Extra-Heavy Duty Minimum Gauge = 16	1	Full Flush (Not applicable)	DL 416, DE 416
		2	Seamless	DL 416, DE 416



Standard 6-Panel Embossment

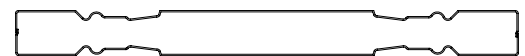

High Def Embossment (1 and 2 Panel only)

## Embossed patterns and sizes



DP SERIES





HONEYCOMB

INSULATED

STEEL STIFFENED

EMBOSSED

P1 - One Panel					
	Width	Height	18 GA	16 GA	
	Over 2'8" – 3'0"	6'8"		\$1,268	N/A
		7'0"		\$1,268	N/A
		8'0"		\$1,518	N/A
	Over 3'0" – 3'6"	6'8"		\$1,407	N/A
		7'0"		\$1,445	N/A
		8'0"		\$1,732	N/A
	P2 - Two Panel				
		Width	Height	18 GA	16 GA
2'8"		6'8"		\$1,302	N/A
		7'0"		\$1,362	N/A
		8'0"		\$1,508	N/A
Over 2'8" – 3'0"		6'8"		\$1,337	N/A
		7'0"		\$1,400	N/A
		8'0"		\$1,508	N/A
Over 3'0" – 3'6"		6'8"		\$1,487	N/A
		7'0"		\$1,506	N/A
		8'0"		\$1,724	N/A
PB2 - Btm Two Panel					
		Width	Height	18 GA	16 GA
	2'8"	6'8"		\$1,295	N/A
		7'0"		\$1,295	N/A
	Over 2'8" – 3'0"	6'8"		\$1,268	N/A
		7'0"		\$1,268	N/A
	Over 3'0" – 3'6"	6'8"		\$1,407	N/A
		7'0"		\$1,445	N/A
	AP2 - Arch Two Panel				
		Width	Height	18 GA	16 GA
2'8"		6'8"		\$1,360	N/A
		7'0"		\$1,409	N/A
Over 2'8" – 3'0"		6'8"		\$1,394	N/A
		7'0"		\$1,437	N/A
Over 3'0" – 3'6"		6'8"		\$1,536	N/A
		7'0"		\$1,560	N/A

P4 - Four Panel					
	Width	Height	18 GA	16 GA	
	2'8"	6'8"		\$1,295	N/A
		7'0"		\$1,295	N/A
		8'0"		\$1,518	N/A
	Over 2'8" – 3'0"	6'8"		\$1,268	N/A
		7'0"		\$1,268	N/A
		8'0"		\$1,518	N/A
	Over 3'0" – 3'6"	6'8"		\$1,407	N/A
		7'0"		\$1,445	N/A
8'0"			\$1,732	N/A	
PB4 - Four Panel					
	Width	Height	18 GA	16 GA	
	2'8"	6'8"		\$1,295	N/A
		7'0"		\$1,295	N/A
	Over 2'8" – 3'0"	6'8"		\$1,268	N/A
		7'0"		\$1,268	N/A
	Over 3'0" – 3'6"	6'8"		\$1,407	N/A
		7'0"		\$1,445	N/A
	6-Panel				
		Width	Height	18 GA	16 GA
2'8"		6'8"		\$1,228	\$1,440
		7'0"		\$1,301	\$1,430
Over 2'8" – 3'0"		6'8"		\$1,228	\$1,440
		7'0"		\$1,301	\$1,430
Over 3'0" – 3'6"		6'8"		\$1,412	N/A
		7'0"		\$1,466	N/A
8-0 x 6-Panel					
	Width	Height	18 GA	16 GA	
	2'8"	8'0"	\$1,581	\$1,861	
	Over 2'8" – 3'0"	8'0"	\$1,581	\$1,861	

1. For patterns, sizes or gauges not shown above please contact Customer Care for availability and options. Minimum buys may be required.
2. See Glass Kit Options section for options and price adders to above styles which do not include pricing for cutout/glass/kits as standard.
3. 6-Panel available STC 40 with Temp rise 250 core (see STC Eco).

CLOSER PREPARATIONS	
Closer reinforcement	\$37.00
Concealed overhead door closer, holder or stop	\$371.00
Allegion Concealed overhead door closer, holder or stop	\$323.00

SPECIAL CONSTRUCTIONS	
Undercut - under 3/8" price as next larger size	No charge
Inverted top channel	No charge
Flush bottom channel	No charge
Dutch door	\$92.00
Unifit Hinge Channel	\$89.00
Seal top or bottom channel and finish smooth each	\$142.00
Mag switch/DPS - Hole only	\$23.00
Mag switch/DPS - Prep and reinf.	\$123.00
Continuous welded edge (N/A in 20 gauge)	\$169.00
Bondo filled edge	\$115.00
Beveled lock edge (1/8" in 2")	\$23.00
10 Gauge hinge and 14 gauge lock channels (DE Series - standard on 14 gauge door)	\$156.00
1-3/8" Thick door (6 Panel only) DE (See <a href="#">Engineering</a> )	\$156.00
Door viewer	\$30.00
Mail slot	\$85.00
Automatic door bottom (mortise type)	\$225.00
Conduit/raceway - includes wire pull	\$190.00

INACTIVE LEAF PREPARATIONS	
Flush bolt embossed top/bottom channel	No charge
Cylindrical (2-3/4") or mortise (3-1/2") dead lock strike	\$61.00
Electric strike (no conduit)	\$135.00
ASA Strike only	\$59.00
Attaching astragal (includes astragal)	\$110.00
Flush bolt prep (ANSI 115.4)	\$95.00
Surface bolt reinforce only	\$36.00
Open back strike	\$161.00

LABEL PREPARATIONS	
Mark numbers	No charge
U.L. Mylar label (standard unless specified otherwise)	\$20.00
U.L. Metal label	\$48.00
Warnock Hersey Metal Label	\$48.00
Hurricane label (See <a href="#">Engineering Section</a> )	\$20.00

LOCK PREPARATIONS	
Special lock location	No charge
Special lock backset up to 5"	No charge
Sectional trim prep (mortise lock with function holes)	\$56.00
Cylindrical dead lock	\$61.00
Mortise dead lock	\$61.00
Rim reinforcement only	\$50.00
Rim reinforcement with function prep	\$56.00
Mortise exit device reinforcement only	\$37.00
Mortise exit device reinforcement with function prep	\$89.00
Allegion Mortise exit device reinforcement with function prep	\$71.00
Concealed vertical rod	\$611.00
Allegion Concealed vertical rod <ul style="list-style-type: none"> <li>▪ Frame mortise strike (per prep)</li> <li>▪ Door per template</li> </ul>	\$476.00
Surface vertical rod reinforcement only	\$82.00
Surface vertical rod reinforcement with function prep	\$99.00
Allegion Surface vertical rod reinforcement with function prep	\$87.00
Exit alarm reinforcement only	\$62.00
Inset exit device (16 gauge doors only)	Consult Factory
Push pull reinforcement	\$40.00

SPECIAL FINISH PREPARATIONS	
Second coat of primer	\$124.00
Finish paint setup charge (never waived)	\$1,350.00
Finish paint <ul style="list-style-type: none"> <li>▪ Minimum quantity of 20 per color</li> <li>▪ Price includes full carton wrap</li> </ul>	\$274.00

GLASS KIT OPTIONS			
	Vision/ Narrow Lite up to 100 inch <sup>2</sup>	Half Glass over 100 inch <sup>2</sup> up to 800 inch <sup>2</sup>	Full Glass over 800 inch <sup>2</sup>
Cutout with kit installed	N/A	N/A	N/A
Cutout with kit and reinf.	\$313	\$356	\$389
Sunburst kit (1/2" glass included)	\$560	N/A	N/A
Muntin bar (each)	\$150	\$150	\$150
Galvanized kit add	\$127	\$127	\$127
Glass pocket add (other than 1/4")	\$209	\$209	\$209

Note: Prices are based on Republic standard lite kit. (No glass unless noted otherwise.)

See [Engineering Section](#) for further options and/or details.

DP SERIES

HONEYCOMB

INSULATED

STEEL STIFFENED

EMBOSSED

CUTOUT ONLY OPTIONS (GLASS KITS AND LOUVERS)			
	Up to 100 inch <sup>2</sup>	Over 100 inch <sup>2</sup> up to 800 inch <sup>2</sup>	Over 800 inch <sup>2</sup>
Panel in place	N/A	N/A	N/A
Cutout only	N/A	N/A	N/A
Cutout with reinforcement	\$167	\$167	N/A
Round cutout only (no reinf)	N/A	N/A	N/A

STEEL TYPE	
Cold rolled steel	N/A
A40 Galvanized Steel	Included

See [Engineering Section](#) for further options and/or details.

HINGE PREPARATIONS	
Special hinge locations	No charge
4-1/2" or 5" Universal hinge prep	No charge
Additional hinge prep (per hinge)	\$25.00
Electric hinge <ul style="list-style-type: none"> <li>▪ Cutout in one hinge reinf.</li> <li>▪ No wiring included, no conduit</li> </ul>	\$25.00
Surface mounted hinges (reinforced only)	\$114.00
Continuous hinge reinforcement	\$88.00
Special backset (per hinge)	\$131.00
Power transfer (no conduit)	\$131.00

## ME SERIES

### Universal frames



refer to technical data sheet on page 10 and 11

- Thickness – Made for two basic door thicknesses: 1-3/8" or 1-3/4" (Consult factory for optional thicknesses)
  - Gauges – 16 or 14 (12 gauge available with coped corner connections for welding)
  - Faces – 3/4" to 4"
  - Standard Rabbets
    - 1-3/8" (actual dimension 1-9/16")
    - 1-3/4" (actual dimension 1-15/16")
    - Rabbet dimension is 3/16" greater than the door thickness
  - Stop – 5/8" standard
  - Closer Reinforcement (Optional) – 1-3/8" x 14" x 14 gauge plate
  - Size Availability
    - Maximum Size 5'0" x 10'0" Single
    - Maximum Size 10'0" x 10'0" Double
  - Label Range – Maximum fire rating 180 minute
  - Hinge Backset – 5/16"
  - Backbend – 7/16" (Single Return)
- Universal Standard/Heavy Weight Hinge – Frames for 1-3/4" doors shall have a 7 gauge steel hinge reinforcement plate, projection welded with provisions for 4-1/2" x 4-1/2" template hinges. Hinge plate is designed to be modified to accept a heavy weight hinge by removing spacer plate.
    - Frames for 1-3/8" doors shall have a 11 gauge steel hinge reinforcement plate, projection welded with provisions for 3-1/2" x 3-1/2" standard weight template hinges
  - Strike Prep – Frames for 1-3/4" doors shall have a 14 gauge steel strike reinforcement plate, extruded and formed to the equivalent of 10 gauge, projection welded with provisions for Universal ANSI A115.1 or ANSI A115.2 strike (4-7/8")
    - Frames for 1-3/8" doors shall have a 14 gauge steel strike reinforcement plate, extruded and formed to the equivalent of 10 gauge projection welded with provision for Universal ANSI A115.3 strike (2-3/4")
- Anchors – Sill anchors are included with all ME frames. All other anchors must be ordered separately.
  - Silencer Prep – 9/32" dia. holes shall be provided as standard on strike jambs and double headers, (3 per strike jamb and 2 per double head). Mutes are not supplied and must be ordered separately.
  - Double Heads – Double heads are undersized 1/16" (except for cased open heads, which are nominal)
  - Mortar Guards – Mortar guards of 26 gauge steel shall be welded to each hinge and strike reinforcement plate
  - Profiles – Equal Rabbet, Unequal Rabbet, Single Rabbet, Double Egress, Cased Opening and Kerf (Special profiles available, consult factory)
  - Handing – Frames are handed

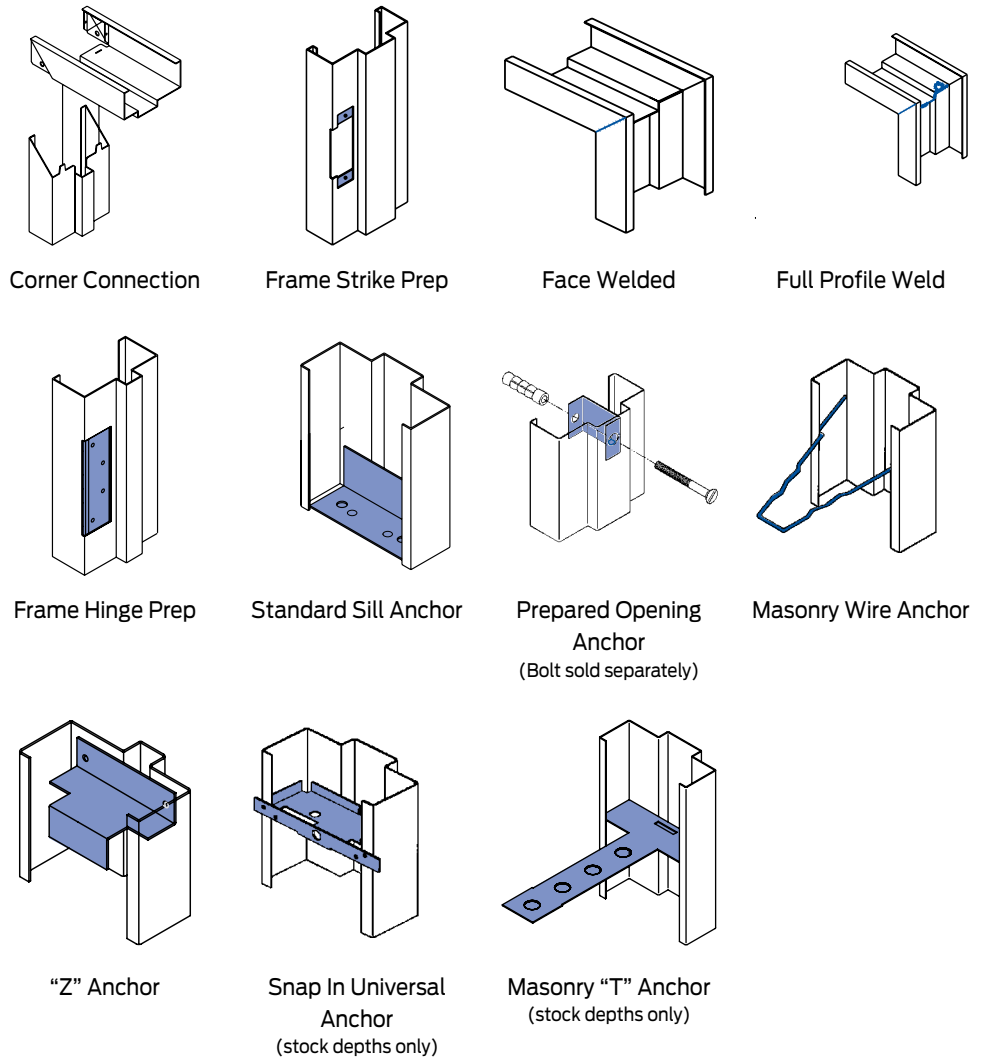
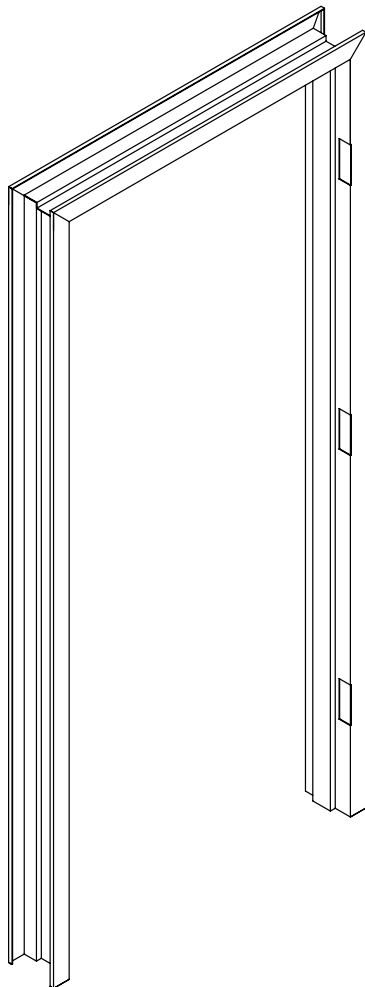

SPECIAL CONSTRUCTIONS	
Description	List add
Special width (use next larger size)	No charge
Special height (use next larger size)	No charge
Communicating (6) 4.5" hinge preps x (2) ASA preps	\$83.00
Dutch prep (4) 4.5" hinge preps x ASA prep	\$85.00
Cap top or bottom of jamb (each)	\$139.00
Mag switch/DPS - Hole only	\$22.00
Mag switch/DPS - Prep and reinf. (no junction box)	\$90.00
Hospital stop (galv) up to 6"	\$222.00
8" Junction box welded in	\$33.00
14" Junction box welded in	\$33.00
10" Junction box welded in soffit	\$33.00

LABEL PREPARATIONS	
Description	List add
Mark numbers	No charge
U.L. Mylar label (standard unless specified otherwise)	\$22.00
U.L. Metal label	\$29.00
ITS/Warnock Hersey Metal label	\$29.00
FBC/Florida building code (See <a href="#">Engineering</a> for details)	\$22.00

SPECIAL FINISH PREPARATIONS	
Description	List add
Second coat of primer	\$109.00
Finish paint setup charge frame (never waived)	\$1,350.00
Finish paint <ul style="list-style-type: none"> <li>▪ Minimum quantity of 20 frames per color</li> <li>▪ Price includes full carton wrap</li> </ul>	\$274.00

Note: Finish paint unavailable on welded frames.

ANCHOR OPTIONS	
Description	List add
Welded in prepared opening anchor (per anchor)	\$16.00
Welded in anchor (per anchor)	\$7.00
Punch and dimple only (per prep)	\$5.50

Note: Frames up to 7'0 quantity of anchors - 6 (max 8-3/4" depth).  
 Frames over 7'0 thru 10'0 quantity of anchors - 8 (max 8-3/4" depth).  
 Frames over 8-3/4" depth receive double anchor quantity.

FRAME CONSTRUCTION	
Description	List add
Unit bundle (3pc)	\$7.00
Standard face weld (3pc)	\$116.00
Full profile weld (3pc)	\$208.00

FRAME PROFILE OPTIONS	
Description	List add
No returns	No charge
Cased open	No charge
Single rabbet	No charge
4" Face heads (through 4'0")	\$59.00
4" Face heads (over 4'0")	\$83.00
Non-standard face - per frame (1" - 3-7/8" uniform)	\$65.00
Non-standard rabbet (per frame)	\$246.00
Kerf (includes weather-stripping) (16 gauge only)	\$183.00
Non-standard returns (uniform)	\$65.00



UNIVERSAL FRAMES 7/16" SINGLE RETURN													
Single		16 Gauge						14 Gauge					
Width	Height	4-5/8" thru 5-7/8"	6" thru 7-7/8"	8" thru 9-7/8"	10" thru 11-7/8"	12" thru 14-3/4"	14-7/8" thru 20"	4-5/8" thru 5-7/8"	5-7/8" thru 7-3/4"	8" thru 9-7/8"	10" thru 11-7/8"	12" thru 14-3/4"	14-7/8" thru 20"
Thru 3'0"	6'8"	\$280	\$307	\$345	\$386	\$458	\$638	\$350	\$374	\$409	\$462	\$548	\$728
	7'0"	\$290	\$326	\$356	\$400	\$474	\$654	\$356	\$390	\$424	\$478	\$565	\$745
	7'2"	\$306	\$340	\$376	\$422	\$498	\$678	\$381	\$412	\$443	\$496	\$589	\$769
	8'0"	\$362	\$380	\$417	\$466	\$545	\$725	\$437	\$459	\$491	\$548	\$637	\$817
	9'0"	\$404	\$435	\$461	\$519	\$606	\$786	\$488	\$519	\$552	\$613	\$716	\$896
	10'0"	\$460	\$492	\$526	\$584	\$676	\$856	\$546	\$572	\$612	\$677	\$790	\$970
Over 3'0" – 4'0"	6'8"	\$296	\$324	\$360	\$402	\$472	\$652	\$359	\$385	\$419	\$476	\$555	\$735
	7'0"	\$306	\$343	\$371	\$416	\$488	\$668	\$365	\$401	\$434	\$492	\$572	\$752
	7'2"	\$322	\$357	\$391	\$438	\$512	\$692	\$390	\$423	\$453	\$510	\$596	\$776
	8'0"	\$378	\$397	\$432	\$482	\$559	\$739	\$446	\$470	\$501	\$562	\$644	\$824
	9'0"	\$420	\$452	\$476	\$535	\$620	\$800	\$497	\$530	\$562	\$627	\$723	\$903
	10'0"	\$476	\$509	\$541	\$600	\$690	\$870	\$555	\$583	\$622	\$691	\$797	\$977
Over 4'0" – 5'0"	6'8"	\$326	\$351	\$389	\$432	\$503	\$683	\$394	\$425	\$456	\$516	\$591	\$771
	7'0"	\$336	\$370	\$400	\$446	\$519	\$699	\$400	\$441	\$471	\$532	\$608	\$788
	7'2"	\$352	\$384	\$420	\$468	\$543	\$723	\$425	\$463	\$490	\$550	\$632	\$812
	8'0"	\$408	\$424	\$461	\$512	\$590	\$770	\$481	\$510	\$538	\$602	\$680	\$860
	9'0"	\$450	\$479	\$505	\$565	\$651	\$831	\$532	\$570	\$599	\$667	\$759	\$939
	10'0"	\$506	\$536	\$570	\$630	\$721	\$901	\$590	\$623	\$659	\$731	\$833	\$1,013

Note: Frames are priced as equal or unequal rabbet. Frames 3"-4-1/2" jamb depth must be single rabbet (minimum 1" soffit).

UNIVERSAL FRAMES 7/16" SINGLE RETURN													
Double		16 Gauge						14 Gauge					
Width	Height	4-5/8" thru 5-7/8"	6" thru 7-7/8"	8" thru 9-7/8"	10" thru 11-7/8"	12" thru 14-3/4"	14-7/8" thru 20"	4-5/8" thru 5-7/8"	6" thru 7-7/8"	8" thru 9-7/8"	10" thru 11-7/8"	12" thru 14-3/4"	14-7/8" thru 20"
Over 4'0" – 5'0"	6'8"	\$339	\$365	\$406	\$449	\$521	\$701	\$405	\$438	\$472	\$537	\$611	\$791
	7'0"	\$347	\$383	\$418	\$461	\$535	\$715	\$415	\$452	\$492	\$545	\$621	\$801
	7'2"	\$365	\$405	\$438	\$485	\$567	\$747	\$437	\$480	\$512	\$567	\$655	\$835
	8'0"	\$437	\$451	\$486	\$537	\$621	\$801	\$509	\$534	\$566	\$629	\$711	\$891
	9'0"	\$483	\$511	\$534	\$593	\$681	\$861	\$565	\$594	\$628	\$697	\$791	\$971
	10'0"	\$541	\$571	\$610	\$667	\$767	\$947	\$623	\$654	\$700	\$759	\$871	\$1,051
Over 5'0" – 6'0"	6'8"	\$349	\$377	\$421	\$463	\$536	\$716	\$420	\$450	\$484	\$544	\$627	\$807
	7'0"	\$357	\$395	\$433	\$475	\$550	\$730	\$430	\$464	\$504	\$552	\$637	\$817
	7'2"	\$375	\$417	\$453	\$499	\$582	\$762	\$452	\$492	\$524	\$574	\$671	\$851
	8'0"	\$447	\$463	\$501	\$551	\$636	\$816	\$524	\$546	\$578	\$636	\$727	\$907
	9'0"	\$493	\$523	\$549	\$607	\$696	\$876	\$580	\$606	\$640	\$704	\$807	\$987
	10'0"	\$551	\$583	\$625	\$681	\$782	\$962	\$638	\$666	\$712	\$766	\$887	\$1,067
Over 6'0" – 8'0"	6'8"	\$373	\$403	\$452	\$493	\$568	\$748	\$446	\$478	\$515	\$582	\$664	\$844
	7'0"	\$381	\$421	\$464	\$505	\$582	\$762	\$456	\$492	\$535	\$590	\$674	\$854
	7'2"	\$399	\$443	\$484	\$529	\$614	\$794	\$478	\$520	\$555	\$612	\$708	\$888
	8'0"	\$471	\$489	\$532	\$581	\$668	\$848	\$550	\$574	\$609	\$674	\$764	\$944
	9'0"	\$517	\$549	\$580	\$637	\$728	\$908	\$606	\$634	\$671	\$742	\$844	\$1,024
	10'0"	\$575	\$609	\$656	\$711	\$814	\$994	\$664	\$694	\$743	\$804	\$924	\$1,104
Over 8'0" – 10'0"	6'8"	\$411	\$444	\$500	\$548	\$623	\$803	\$493	\$532	\$579	\$648	\$733	\$913
	7'0"	\$419	\$462	\$512	\$560	\$637	\$817	\$503	\$546	\$599	\$656	\$743	\$923
	7'2"	\$437	\$484	\$532	\$584	\$669	\$849	\$525	\$574	\$619	\$678	\$777	\$957
	8'0"	\$509	\$530	\$580	\$636	\$723	\$903	\$597	\$628	\$673	\$740	\$833	\$1,013
	9'0"	\$555	\$590	\$628	\$692	\$783	\$963	\$653	\$688	\$735	\$808	\$913	\$1,093
	10'0"	\$613	\$650	\$704	\$766	\$869	\$1,049	\$711	\$748	\$807	\$870	\$993	\$1,173

Note: Frames are priced as equal or unequal rabbet. Frames 3"-4-1/2" jamb depth must be single rabbet (minimum 1" soffit).

COMPONENTS UNIVERSAL FRAMES 7/16" SINGLE RETURN													
Header		16 Gauge						14 Gauge					
	Width	4-5/8" thru 5-7/8"	6" thru 7-7/8"	8" thru 9-7/8"	10" thru 11-7/8"	12" thru 14-3/4"	14-7/8" thru 20"	4-5/8" thru 5-7/8"	6" thru 7-7/8"	8" thru 9-7/8"	10" thru 11-7/8"	12" thru 14-3/4"	14-7/8" thru 20"
SGL Head	Thru 3'0"	\$55	\$63	\$72	\$85	\$108	\$168	\$75	\$81	\$97	\$111	\$140	\$200
	Over 3'0" – 4'0"	\$71	\$80	\$87	\$101	\$122	\$182	\$84	\$92	\$107	\$125	\$147	\$207
	Over 4'0" – 5'0"	\$101	\$107	\$116	\$131	\$153	\$213	\$119	\$132	\$144	\$165	\$183	\$243
DBL Head	Over 5'0" – 6'0"	\$111	\$119	\$131	\$145	\$168	\$228	\$134	\$144	\$156	\$172	\$199	\$259
	Over 6'0" – 8'0"	\$135	\$145	\$162	\$175	\$200	\$260	\$160	\$172	\$187	\$210	\$236	\$296
	Over 8'0" – 10'0"	\$173	\$186	\$210	\$230	\$255	\$315	\$207	\$226	\$251	\$276	\$305	\$365

COMPONENTS UNIVERSAL FRAMES 7/16" SINGLE RETURN													
Jamb Pair		16 Gauge						14 Gauge					
	Height	4-5/8" thru 5-7/8"	6" thru 7-7/8"	8" thru 9-7/8"	10" thru 11-7/8"	12" thru 14-3/4"	14-7/8" thru 20"	4-5/8" thru 5-7/8"	6" thru 7-7/8"	8" thru 9-7/8"	10" thru 11-7/8"	12" thru 14-3/4"	14-7/8" thru 20"
SGL Pair	6'8"	\$225	\$244	\$273	\$301	\$350	\$470	\$275	\$293	\$312	\$351	\$408	\$528
	7'0"	\$235	\$263	\$284	\$315	\$366	\$486	\$281	\$309	\$327	\$367	\$425	\$545
	7'2"	\$251	\$277	\$304	\$337	\$390	\$510	\$306	\$331	\$346	\$385	\$449	\$569
	8'0"	\$307	\$317	\$345	\$381	\$437	\$557	\$362	\$378	\$394	\$437	\$497	\$617
	9'0"	\$349	\$372	\$389	\$434	\$498	\$618	\$413	\$438	\$455	\$502	\$576	\$696
	10'0"	\$405	\$429	\$454	\$499	\$568	\$688	\$471	\$491	\$515	\$566	\$650	\$770
DBL Pair	6'8"	\$238	\$258	\$290	\$318	\$368	\$488	\$286	\$306	\$328	\$372	\$428	\$548
	7'0"	\$246	\$276	\$302	\$330	\$382	\$502	\$296	\$320	\$348	\$380	\$438	\$558
	7'2"	\$264	\$298	\$322	\$354	\$414	\$534	\$318	\$348	\$368	\$402	\$472	\$592
	8'0"	\$336	\$344	\$370	\$406	\$468	\$588	\$390	\$402	\$422	\$464	\$528	\$648
	9'0"	\$382	\$404	\$418	\$462	\$528	\$648	\$446	\$462	\$484	\$532	\$608	\$728
	10'0"	\$440	\$464	\$494	\$536	\$614	\$734	\$504	\$522	\$556	\$594	\$688	\$808

STEEL TYPES	
Description	List add
Cold rolled steel	Included
A60 Galvanized steel	\$56.00
G90 Galvanized steel (available in 14 and 16 gauge only)	\$102.00
12 Gauge - See <a href="#">Stick Section</a>	N/A

HINGE PREPARATIONS	
Description	List add
Special hinge locations	No charge
4-1/2" or 5" Universal hinge prep	No charge
Additional hinge prep (per hinge)	\$23.00
4" Template hinge prep (square corner only) (per hinge)	\$58.00
Electric hinge <ul style="list-style-type: none"> <li>One 1/2" dia. hole in one hinge reinf.</li> <li>No wiring included, no junction box</li> </ul>	\$22.00
Continuous hinge reinforcement (rabbet or face)	\$83.00
Power transfer (no junction box)	\$104.00

See page 102 for more options.

See [Engineering Section](#) for further options and/or details.

FRAME - STRIKE PREPARATIONS	
Description	List add
Special strike location	No charge
Standard strike at non standard location	No charge
Cylindrical dead lock (2-3/4" strike)	\$23.00
Mortise dead lock (3-1/2" strike)	\$23.00
Unit lock/double strike prep (ex. Schlage H)	N/A
Rim reinforcement only	\$30.00
Surface vertical rod reinforcement only	\$30.00
Concealed vertical rod (mortise strike) (per prep)	\$69.00
Exit alarm reinforcement only	\$29.00
Electric strike (no junction box)	\$68.00
Flush bolt strike prep/reversible or automatic	\$59.00
Surface bolt reinforce only	\$30.00

CLOSER PREPARATIONS	
Description	List add
Closer reinforcement - 14 GA Plate - RA or PA	\$29.00
Full depth reinforcement (price per foot)	\$32.00
Concealed overhead door closer, holder or stop	\$289.00
Allegion Concealed overhead door closer, holder or stop	\$262.00

## MH SERIES

### Drywall frames

Refer to technical data sheet on page 12

- Thickness – Made for two basic door thicknesses: 1-3/8" or 1-3/4" (Consult factory for optional thicknesses)
  - Gauges – 16 or 14
  - Faces – 1-1/4" to 4"
  - Standard Rabbets
    - 1-3/8" (actual dimension 1-9/16")
    - 1-3/4" (actual dimension 1-15/16")
    - Rabbet dimension is 3/16" greater than the door thickness
  - Stop – 5/8" standard
  - Closer Reinforcement (Optional) – 1-3/8" x 14" x 14 gauge plate
  - Size Availability
    - Maximum Size 5'0" x 10'0" Single
    - Maximum Size 10'0" x 10'0" Double
  - Label Range – Maximum fire rating 90 minute with compression anchors
  - Hinge Backset – 5/16"
  - Backbend – 1/2" (Double Return)
- Universal Standard/Heavy Weight Hinge – Frames for 1-3/4" doors shall have a 7 gauge steel hinge reinforcement plate, projection welded with provisions for 4-1/2" x 4-1/2" template hinges. Hinge plate is designed to be modified to accept a heavy weight hinge by removing spacer plate
    - Frames for 1-3/8" doors shall have a 11 gauge steel hinge reinforcement plate, projection welded with provisions for 3-1/2" x 3-1/2" standard weight template hinges
  - Strike Prep – Frames for 1-3/4" doors shall have a 14 gauge steel strike reinforcement plate, extruded and formed to the equivalent of 10 gauge, projection welded with provisions for Universal ANSI A115.1 or ANSI A115.2 strike (4-7/8")
    - Frames for 1-3/8" doors shall have a 14 gauge steel strike reinforcement plate, extruded and formed to the equivalent of 10 gauge projection welded with provision for Universal ANSI A115.3 strike (2-3/4")
- Anchors – Welded in compression anchors with loose sill anchors and hole plugs (Ordered separately)
  - Silencer Prep – 9/32" dia. holes shall be provided as standard on strike jambs and double headers, (3 per strike jamb and 2 per double head). Mutes are not supplied and must be ordered separately.
  - Double Heads – Double heads are undersized 1/16" (except for cased open heads, which are nominal)
  - Profiles – Equal Rabbet, Unequal Rabbet, Single Rabbet, Double Egress, Cased Opening and Kerf. (Special profiles available, consult factory)
  - Handing – Frames are handed

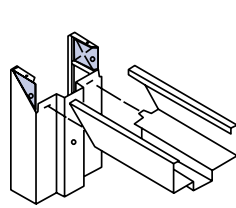
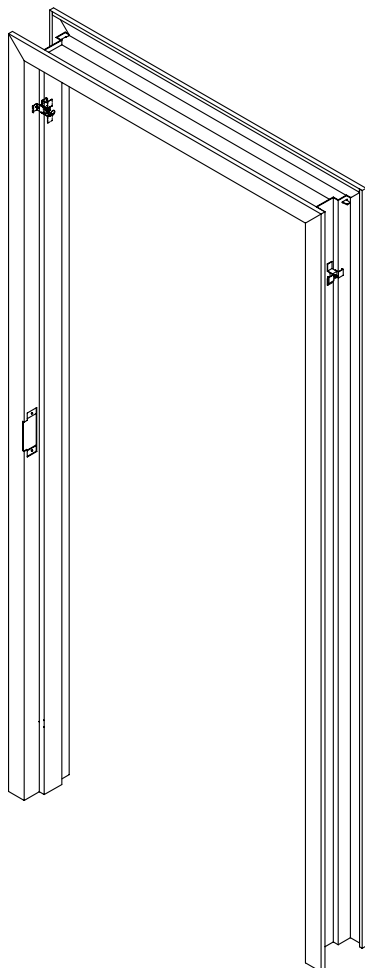

MH Corner Connection

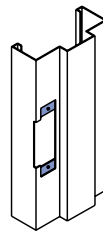

Frame Strike Prep

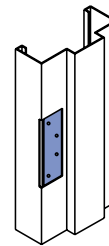

Frame Hinge Prep

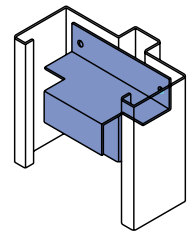

"Z" Anchor (Optional)  
(welded in)

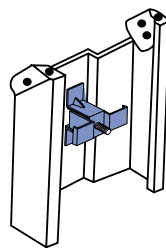

Compression Anchor

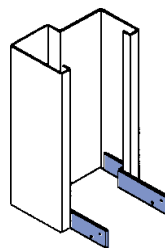

Drywall Sill Anchor  
(Sold/Shipped Loose)

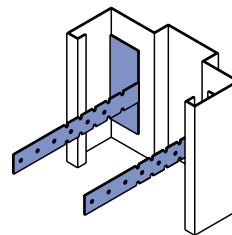

L Strap Anchor  
(Optional)

SPECIAL CONSTRUCTIONS	
Description	List add
Special width (use next larger size)	No charge
Special height (use next larger size)	No charge
Communicating (6) 4.5" hinge preps x (2) ASA preps	\$83.00
Dutch prep (4) 4.5" hinge preps x ASA prep	\$85.00
Cap top or bottom of jamb (each)	\$139.00
Mag switch/DPS - Hole only	\$22.00
Mag switch/DPS - Prep and reinf. (no junction box)	\$90.00
Hospital stop (galv) up to 6"	\$222.00
8" Junction box welded in	N/A
14" Junction box welded in	N/A
10" Junction box welded in soffit	\$33.00

LABEL PREPARATIONS	
Description	List add
Mark numbers	No charge
U.L. Mylar label (standard unless specified otherwise)	\$22.00
U.L. Metal label	\$29.00
ITS/Warnock Hersey Metal label	\$29.00

1. Maximum fire rating 1-1/2 hour with compression anchors.
2. Single rabbet min 3", max 4-3/8" depth.
3. Double rabbet min 4-1/2", max 15" depth.

SPECIAL FINISH PREPARATIONS	
Description	List add
Second coat of primer	\$109.00
Finish paint setup charge (never waived)	\$1,350.00
Finish paint <ul style="list-style-type: none"> <li>▪ Minimum quantity of 20 frames per color</li> <li>▪ Price includes full carton wrap</li> </ul>	\$274.00

Note: Finish paint unavailable on welded frames.

ANCHOR OPTIONS	
Description	Price adjustment
Welded in anchor (per anchor)	\$7.00
Omit drywall compression anchor (deduct)	-\$6.00
Embossed hole at bottom face	No charge

Drywall frames standard with (1) each compression anchor per jamb.

FRAME CONSTRUCTION	
Description	List add
Unit bundle (3pc)	\$7.00
Standard face weld (3pc) (omit compression anchor)	\$116.00
Full profile weld (3pc) (omit compression anchor)	\$208.00

FRAME PROFILE OPTIONS	
Description	List add
No returns	No charge
Cased open	No charge
Single rabbet	No charge
4" Face heads (through 4'0")	\$59.00
4" Face heads (over 4'0")	\$83.00
Non-standard face - per frame (1" - 3-7/8" uniform)	\$65.00
Non-standard rabbet (per frame)	\$246.00
Kerf (includes weather-stripping) (16 gauge only)	\$183.00

FRAMES 1/2" DOUBLE RETURN X COMPRESSION ANCHORS													
Single		16 Gauge						14 Gauge					
Width	Height	4-1/2" thru 5-7/8"	6" thru 7-7/8"	8" thru 9-7/8"	10" thru 11-7/8"	12" thru 14-3/4"	14-7/8" thru 20"	4-1/2" thru 5-7/8"	6" thru 7-7/8"	8" thru 9-7/8"	10" thru 11-7/8"	12" thru 14-3/4"	14-7/8" thru 20"
Thru 3'0"	6'8"	\$301	\$351	\$386	\$434	\$515	\$695	\$386	\$442	\$477	\$539	\$638	\$818
	7'0"	\$323	\$367	\$400	\$452	\$536	\$716	\$409	\$457	\$495	\$558	\$656	\$836
	7'2"	\$339	\$384	\$418	\$473	\$562	\$742	\$417	\$475	\$512	\$573	\$683	\$863
	8'0"	\$381	\$430	\$464	\$516	\$611	\$791	\$475	\$517	\$563	\$615	\$716	\$896
	9'0"	\$433	\$495	\$527	\$580	\$688	\$868	\$530	\$588	\$632	\$698	\$812	\$992
	10'0"	\$508	\$560	\$608	\$657	\$748	\$928	\$620	\$674	\$725	\$771	\$877	\$1,057
Over 3'0" – 4'0"	6'8"	\$316	\$367	\$398	\$450	\$526	\$706	\$394	\$456	\$486	\$559	\$646	\$826
	7'0"	\$338	\$383	\$412	\$468	\$547	\$727	\$417	\$471	\$504	\$578	\$664	\$844
	7'2"	\$354	\$400	\$430	\$489	\$573	\$753	\$425	\$489	\$521	\$593	\$691	\$871
	8'0"	\$396	\$446	\$476	\$532	\$622	\$802	\$483	\$531	\$572	\$635	\$724	\$904
	9'0"	\$448	\$511	\$539	\$596	\$699	\$879	\$538	\$602	\$641	\$718	\$820	\$1,000
	10'0"	\$523	\$576	\$620	\$673	\$759	\$939	\$628	\$688	\$734	\$791	\$885	\$1,065
Over 4'0" – 5'0"	6'8"	\$354	\$396	\$434	\$482	\$561	\$741	\$450	\$507	\$540	\$607	\$697	\$877
	7'0"	\$376	\$412	\$448	\$500	\$582	\$762	\$473	\$522	\$558	\$626	\$715	\$895
	7'2"	\$392	\$429	\$466	\$521	\$608	\$788	\$481	\$540	\$575	\$641	\$742	\$922
	8'0"	\$434	\$475	\$512	\$564	\$657	\$837	\$539	\$582	\$626	\$683	\$775	\$955
	9'0"	\$486	\$540	\$575	\$628	\$734	\$914	\$594	\$653	\$695	\$766	\$871	\$1,051
	10'0"	\$561	\$605	\$656	\$705	\$794	\$974	\$684	\$739	\$788	\$839	\$936	\$1,116

Note: Frames are priced as equal or unequal rabbet. Frames 3"-4-1/2" jamb depth must be single rabbet (minimum 1" soffit).

FRAMES 1/2" DOUBLE RETURN X COMPRESSION ANCHORS													
Double		16 Gauge						14 Gauge					
Width	Height	4-1/2" thru 5-7/8"	6" thru 7-7/8"	8" thru 9-7/8"	10" thru 11-7/8"	12" thru 14-3/4"	14-7/8" thru 20"	4-1/2" thru 5-7/8"	6" thru 7-7/8"	8" thru 9-7/8"	10" thru 11-7/8"	12" thru 14-3/4"	14-7/8" thru 20"
Over 4'0" – 6'0"	6'8"	\$366	\$414	\$456	\$501	\$581	\$761	\$469	\$534	\$556	\$623	\$714	\$894
	7'0"	\$384	\$424	\$472	\$515	\$603	\$783	\$491	\$542	\$576	\$643	\$732	\$912
	7'2"	\$402	\$448	\$488	\$541	\$637	\$817	\$503	\$566	\$594	\$665	\$762	\$942
	8'0"	\$456	\$502	\$546	\$599	\$685	\$865	\$567	\$622	\$664	\$715	\$804	\$984
	9'0"	\$514	\$570	\$610	\$663	\$769	\$949	\$635	\$708	\$748	\$827	\$930	\$1,110
	10'0"	\$604	\$638	\$700	\$735	\$831	\$1,011	\$717	\$782	\$824	\$879	\$968	\$1,148
Over 6'0" – 8'0"	6'8"	\$388	\$439	\$481	\$529	\$612	\$792	\$500	\$565	\$589	\$654	\$754	\$934
	7'0"	\$406	\$449	\$497	\$543	\$634	\$814	\$522	\$573	\$609	\$674	\$772	\$952
	7'2"	\$424	\$473	\$513	\$569	\$668	\$848	\$534	\$597	\$627	\$696	\$802	\$982
	8'0"	\$478	\$527	\$571	\$627	\$716	\$896	\$598	\$653	\$697	\$746	\$844	\$1,024
	9'0"	\$536	\$595	\$635	\$691	\$800	\$980	\$666	\$739	\$781	\$858	\$970	\$1,150
	10'0"	\$626	\$663	\$725	\$763	\$862	\$1,042	\$748	\$813	\$857	\$910	\$1,008	\$1,188
Over 8'0" – 9'0"	6'8"	\$407	\$469	\$519	\$569	\$652	\$832	\$511	\$582	\$616	\$684	\$783	\$963
	7'0"	\$425	\$479	\$535	\$583	\$674	\$854	\$533	\$590	\$636	\$704	\$801	\$981
	7'2"	\$443	\$503	\$551	\$609	\$708	\$888	\$545	\$614	\$654	\$726	\$831	\$1,011
	8'0"	\$497	\$557	\$609	\$667	\$756	\$936	\$609	\$670	\$724	\$776	\$873	\$1,053
	9'0"	\$555	\$625	\$673	\$731	\$840	\$1,020	\$677	\$756	\$808	\$888	\$999	\$1,179
	10'0"	\$645	\$693	\$763	\$803	\$902	\$1,082	\$759	\$830	\$884	\$940	\$1,037	\$1,217
Over 9'0" – 10'0"	6'8"	\$447	\$522	\$577	\$630	\$718	\$898	\$577	\$650	\$685	\$753	\$853	\$1,033
	7'0"	\$465	\$532	\$593	\$644	\$740	\$920	\$599	\$658	\$705	\$773	\$871	\$1,051
	7'2"	\$483	\$556	\$609	\$670	\$774	\$954	\$611	\$682	\$723	\$795	\$901	\$1,081
	8'0"	\$537	\$610	\$667	\$728	\$822	\$1,002	\$675	\$738	\$793	\$845	\$943	\$1,123
	9'0"	\$595	\$678	\$731	\$792	\$906	\$1,086	\$743	\$824	\$877	\$957	\$1,069	\$1,249
	10'0"	\$685	\$746	\$821	\$864	\$968	\$1,148	\$825	\$898	\$953	\$1,009	\$1,107	\$1,287

Note: Frames are priced as equal or unequal rabbet. Frames 3"-4-1/2" jamb depth must be single rabbet (minimum 1" soffit).

COMPONENT FRAMES 1/2" DOUBLE RETURN X COMPRESSION ANCHORS													
Header		16 Gauge						14 Gauge					
	Width	4-1/2" thru 5-7/8"	6" thru 7-7/8"	8" thru 9-7/8"	10" thru 11-7/8"	12" thru 14-3/4"	14-7/8" thru 20"	4-1/2" thru 5-7/8"	6" thru 7-7/8"	8" thru 9-7/8"	10" thru 11-7/8"	12" thru 14-3/4"	14-7/8" thru 20"
SGL Head	Thru 3'0"	\$57	\$73	\$84	\$97	\$123	\$183	\$81	\$91	\$101	\$113	\$141	\$201
	Over 3'0" – 4'0"	\$72	\$89	\$96	\$113	\$134	\$194	\$89	\$105	\$110	\$133	\$149	\$209
	Over 4'0" – 5'0"	\$110	\$118	\$132	\$145	\$169	\$229	\$145	\$156	\$164	\$181	\$200	\$260
DBL Head	Over 5'0" – 6'0"	\$110	\$118	\$132	\$145	\$169	\$229	\$145	\$156	\$164	\$181	\$200	\$260
	Over 6'0" – 8'0"	\$132	\$143	\$157	\$173	\$200	\$260	\$176	\$187	\$197	\$212	\$240	\$300
	Over 8'0" – 10'0"	\$191	\$226	\$253	\$274	\$306	\$366	\$253	\$272	\$293	\$311	\$339	\$399

COMPONENT FRAMES 1/2" DOUBLE RETURN X COMPRESSION ANCHORS													
Jamb Pair		16 Gauge						14 Gauge					
	Height	4-1/2" thru 5-7/8"	6" thru 7-7/8"	8" thru 9-7/8"	10" thru 11-7/8"	12" thru 14-3/4"	14-7/8" thru 20"	4-1/2" thru 5-7/8"	6" thru 7-7/8"	8" thru 9-7/8"	10" thru 11-7/8"	12" thru 14-3/4"	14-7/8" thru 20"
SGL Pair	6'8"	\$244	\$278	\$302	\$337	\$392	\$512	\$305	\$351	\$376	\$426	\$497	\$617
	7'0"	\$266	\$294	\$316	\$355	\$413	\$533	\$328	\$366	\$394	\$445	\$515	\$635
	7'2"	\$282	\$311	\$334	\$376	\$439	\$559	\$336	\$384	\$411	\$460	\$542	\$662
	8'0"	\$324	\$357	\$380	\$419	\$488	\$608	\$394	\$426	\$462	\$502	\$575	\$695
	9'0"	\$376	\$422	\$443	\$483	\$565	\$685	\$449	\$497	\$531	\$585	\$671	\$791
	10'0"	\$451	\$487	\$524	\$560	\$625	\$745	\$539	\$583	\$624	\$658	\$736	\$856
DBL Pair	6'8"	\$256	\$296	\$324	\$356	\$412	\$532	\$324	\$378	\$392	\$442	\$514	\$634
	7'0"	\$274	\$306	\$340	\$370	\$434	\$554	\$346	\$386	\$412	\$462	\$532	\$652
	7'2"	\$292	\$330	\$356	\$396	\$468	\$588	\$358	\$410	\$430	\$484	\$562	\$682
	8'0"	\$346	\$384	\$414	\$454	\$516	\$636	\$422	\$466	\$500	\$534	\$604	\$724
	9'0"	\$404	\$452	\$478	\$518	\$600	\$720	\$490	\$552	\$584	\$646	\$730	\$850
	10'0"	\$494	\$520	\$568	\$590	\$662	\$782	\$572	\$626	\$660	\$698	\$768	\$888

STEEL TYPES	
Description	List add
Cold rolled steel	Included
A60 Galvanized steel	\$56.00
G90 Galvanized steel (available in 14 and 16 gauge only)	\$102.00
12 Gauge - N/A with drywall returns	N/A

HINGE PREPARATIONS	
Description	List add
Special hinge locations	No charge
4-1/2" or 5" Universal hinge prep	No charge
Additional hinge prep (per hinge)	\$23.00
Electric hinge <ul style="list-style-type: none"> <li>▪ One 1/2" dia. hole in one hinge reinf.</li> <li>▪ No wiring included, no junction box</li> </ul>	\$22.00
Continuous hinge reinforcement (rabbet or face)	\$83.00
Power transfer (no junction box)	\$104.00

See page 102 for more options.

See [Engineering Section](#) for further options and/or details.

FRAME - STRIKE PREPARATIONS	
Description	List add
Special strike location	No charge
Standard strike at non-standard location	No charge
Cylindrical dead lock (2-3/4" strike)	\$23.00
Mortise dead lock (3-1/2" strike)	\$23.00
Unit lock/double strike prep (ex. Schlage H)	N/A
Rim reinforcement only	\$30.00
Surface vertical rod reinforcement only	\$30.00
Concealed vertical rod (mortise strike) (per prep)	\$69.00
Exit alarm reinforcement only	\$29.00
Electric strike (no junction box)	\$68.00
Flush bolt strike prep/reversible or automatic	\$59.00
Surface bolt reinforce only	\$30.00

CLOSER PREPARATIONS	
Description	List add
Closer reinforcement - 14 gauge plate - RA or PA	\$29.00
Full depth reinforcement (price per foot)	\$32.00
Concealed overhead door closer, holder or stop	\$289.00
Allegion Concealed overhead door closer, holder or stop	\$262.00

## ME SERIES

### Double egress

refer to technical data sheet on page 10 and 11

- Double Egress Openings are designed to permit the flow of traffic in two directions through the same opening
  - All double egress openings shall be supplied as right hand swing unless otherwise specified
- Fire Labeled – Maximum 3 hour
- Face – 1-3/8" standard, 2" optional
- Universal Standard/Heavy Weight Hinge – Frames for 1-3/4" doors shall have a 7 gauge steel hinge reinforcement plate, projection welded with provisions for 4-1/2" x 4-1/2" template hinges. Hinge plate is designed to be modified to accept a heavy weight hinge by removing spacer plate.
- Frames for 1-3/8" doors shall have a 11 gauge steel hinge reinforcement plate, projection welded with provisions for 3-1/2" x 3-1/2" standard weight template hinges
- Hinge Backset – 5/16"
- Backbend – 7/16" (Single Return)

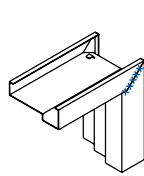
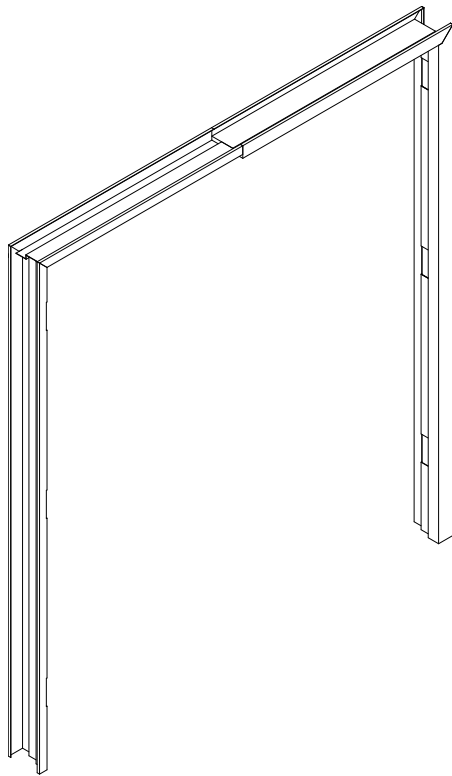

Welded Corner Connection

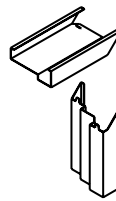

Double Egress Corner

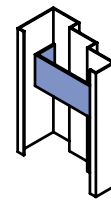

Double Egress Anchor (welded in)

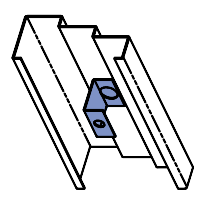

Double Egress Prepared Opening Anchor

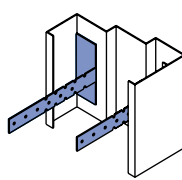

L Strap Anchor Double Egress (Wood Stud) (welded in)

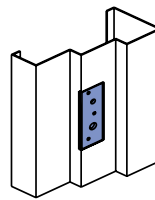

Double Egress Hinge

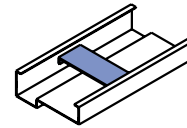

Double Egress Head Anchor (welded in)

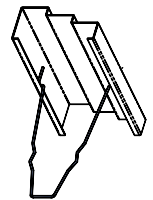

Double Egress Wire Anchor

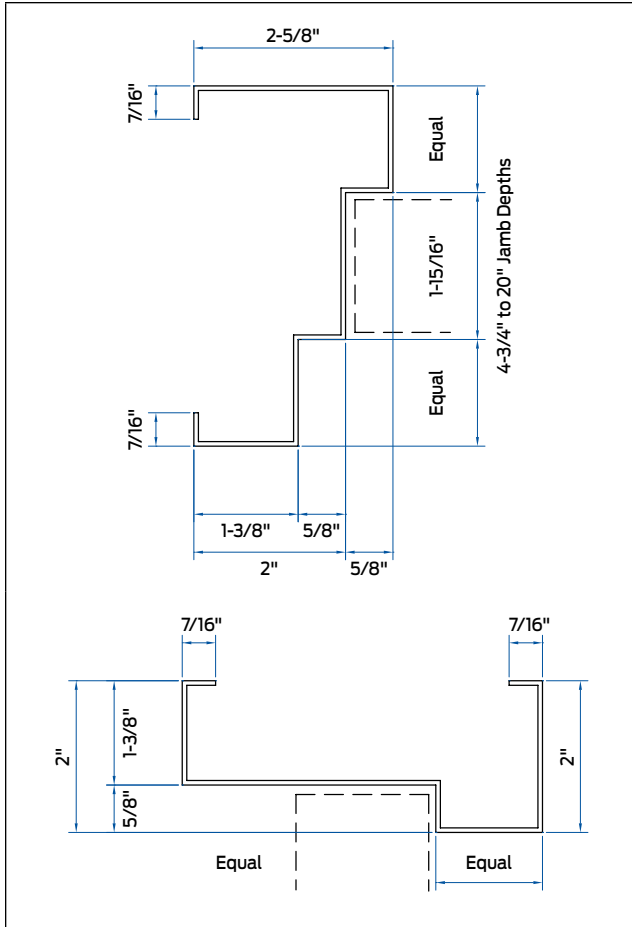

1-3/8" Face (standard)

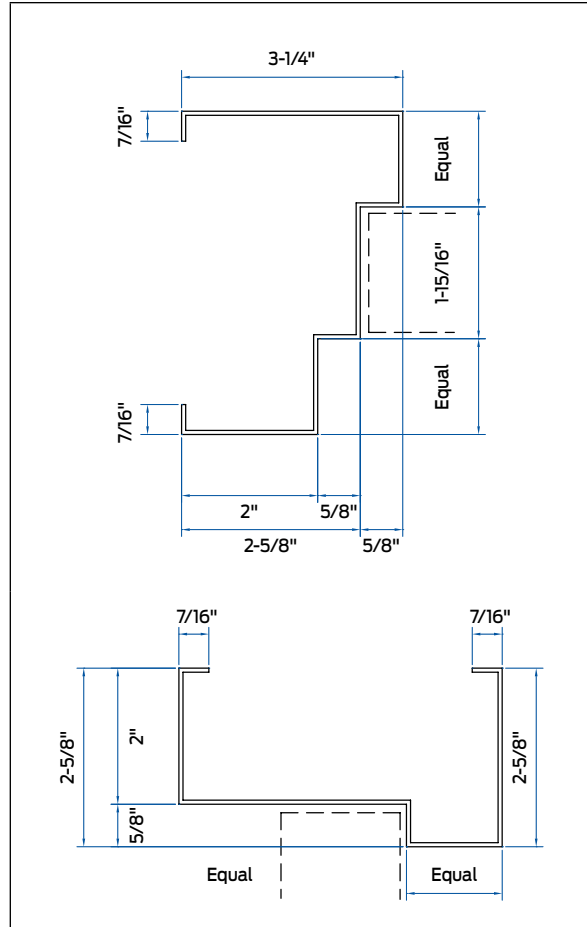

2" Face (optional)

Rough Opening Required for Butted Frame
Door Width Opening + 2x Smaller Face Dimension + 1-3/4"
Door Height Opening + Smaller Face Dimension + 1/4"

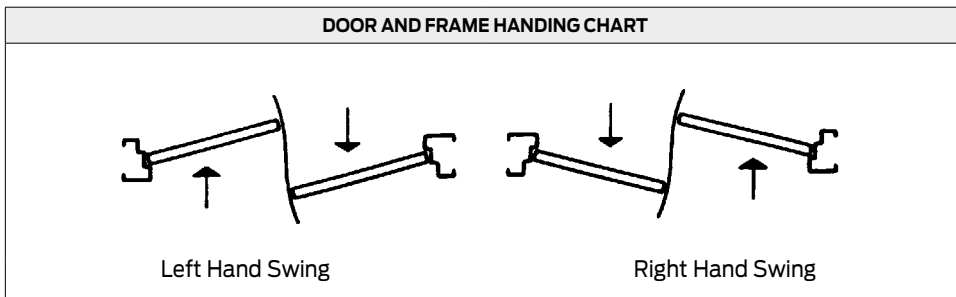



FRAMES 7/16" SINGLE RETURN X 1-3/8" FACE													
Width	Height	16 Gauge						14 Gauge					
		4-1/2" thru 5-7/8"	6" thru 7-7/8"	8" thru 9-7/8"	10" thru 11-7/8"	12" thru 14"	14-1/8" thru 20"	4-1/2" thru 5-7/8"	6" thru 7-7/8"	8" thru 9-7/8"	10" thru 11-7/8"	12" thru 14"	14-1/8" thru 20"
Thru 6'0"	6'8"	\$926	\$959	\$990	\$1,060	\$1,162	\$1,342	\$1,013	\$1,031	\$1,075	\$1,164	\$1,253	\$1,433
	7'0"	\$932	\$961	\$998	\$1,070	\$1,170	\$1,350	\$1,027	\$1,051	\$1,097	\$1,174	\$1,277	\$1,457
	7'2"	\$964	\$987	\$1,022	\$1,090	\$1,192	\$1,372	\$1,051	\$1,057	\$1,107	\$1,180	\$1,289	\$1,469
	8'0"	\$1,022	\$1,047	\$1,078	\$1,150	\$1,258	\$1,438	\$1,123	\$1,137	\$1,181	\$1,256	\$1,377	\$1,557
	9'0"	\$1,048	\$1,083	\$1,112	\$1,174	\$1,292	\$1,472	\$1,141	\$1,181	\$1,215	\$1,284	\$1,407	\$1,587
	10'0"	\$1,094	\$1,123	\$1,162	\$1,236	\$1,350	\$1,530	\$1,187	\$1,215	\$1,261	\$1,352	\$1,473	\$1,653
Over 6'0" – 8'0"	6'8"	\$960	\$993	\$1,027	\$1,096	\$1,198	\$1,378	\$1,040	\$1,068	\$1,111	\$1,199	\$1,296	\$1,476
	7'0"	\$966	\$995	\$1,035	\$1,106	\$1,206	\$1,386	\$1,054	\$1,088	\$1,133	\$1,209	\$1,320	\$1,500
	7'2"	\$998	\$1,021	\$1,059	\$1,126	\$1,228	\$1,408	\$1,078	\$1,094	\$1,143	\$1,215	\$1,332	\$1,512
	8'0"	\$1,056	\$1,081	\$1,115	\$1,186	\$1,294	\$1,474	\$1,150	\$1,174	\$1,217	\$1,291	\$1,420	\$1,600
	9'0"	\$1,082	\$1,117	\$1,149	\$1,210	\$1,328	\$1,508	\$1,168	\$1,218	\$1,251	\$1,319	\$1,450	\$1,630
Over 8'0" – 9'0"	6'8"	\$978	\$1,024	\$1,055	\$1,111	\$1,220	\$1,400	\$1,075	\$1,104	\$1,143	\$1,223	\$1,321	\$1,501
	7'0"	\$984	\$1,026	\$1,063	\$1,121	\$1,228	\$1,408	\$1,089	\$1,124	\$1,165	\$1,233	\$1,345	\$1,525
	7'2"	\$1,016	\$1,052	\$1,087	\$1,141	\$1,250	\$1,430	\$1,113	\$1,130	\$1,175	\$1,239	\$1,357	\$1,537
	8'0"	\$1,074	\$1,112	\$1,143	\$1,201	\$1,316	\$1,496	\$1,185	\$1,210	\$1,249	\$1,315	\$1,445	\$1,625
	9'0"	\$1,100	\$1,148	\$1,177	\$1,225	\$1,350	\$1,530	\$1,203	\$1,254	\$1,283	\$1,343	\$1,475	\$1,655
Over 9'0" – 10'0"	6'8"	\$1,037	\$1,097	\$1,129	\$1,186	\$1,300	\$1,480	\$1,143	\$1,190	\$1,231	\$1,317	\$1,413	\$1,593
	7'0"	\$1,043	\$1,099	\$1,137	\$1,196	\$1,308	\$1,488	\$1,157	\$1,210	\$1,253	\$1,327	\$1,437	\$1,617
	7'2"	\$1,075	\$1,125	\$1,161	\$1,216	\$1,330	\$1,510	\$1,181	\$1,216	\$1,263	\$1,333	\$1,449	\$1,629
	8'0"	\$1,133	\$1,185	\$1,217	\$1,276	\$1,396	\$1,576	\$1,253	\$1,296	\$1,337	\$1,409	\$1,537	\$1,717
	9'0"	\$1,159	\$1,221	\$1,251	\$1,300	\$1,430	\$1,610	\$1,271	\$1,340	\$1,371	\$1,437	\$1,567	\$1,747
10'0"	\$1,205	\$1,261	\$1,301	\$1,362	\$1,488	\$1,668	\$1,317	\$1,374	\$1,417	\$1,505	\$1,633	\$1,813	

Minimum jamb depth is 4-1/2".

COMPONENT FRAMES 7/16" SINGLE RETURN X 1-3/8" FACE													
Heads		16 Gauge						14 Gauge					
	Width	4-1/2" thru 5-7/8"	6" thru 7-7/8"	8" thru 9-7/8"	10" thru 11-7/8"	12" thru 14"	14-1/8" thru 20"	4-1/2" thru 5-7/8"	6" thru 7-7/8"	8" thru 9-7/8"	10" thru 11-7/8"	12" thru 14"	14-1/8" thru 20"
DBL Head	Thru 6'0"	\$322	\$331	\$342	\$366	\$400	\$460	\$357	\$359	\$375	\$402	\$433	\$493
	Over 6'0" – 8'0"	\$356	\$365	\$379	\$402	\$436	\$496	\$384	\$396	\$411	\$437	\$476	\$536
	Over 8'0" – 9'0"	\$374	\$396	\$407	\$417	\$458	\$518	\$419	\$432	\$443	\$461	\$501	\$561
	Over 9'0" – 10'0"	\$433	\$469	\$481	\$492	\$538	\$598	\$487	\$518	\$531	\$555	\$593	\$653

COMPONENT FRAMES 7/16" SINGLE RETURN X 1-3/8" FACE													
Jamb Pairs		16 Gauge						14 Gauge					
	Height	4-1/2" thru 5-7/8"	6" thru 7-7/8"	8" thru 9-7/8"	10" thru 11-7/8"	12" thru 14"	14-1/8" thru 20"	4-1/2" thru 5-7/8"	6" thru 7-7/8"	8" thru 9-7/8"	10" thru 11-7/8"	12" thru 14"	14-1/8" thru 20"
DBL Pair	6'8"	\$604	\$628	\$648	\$694	\$762	\$882	\$656	\$672	\$700	\$762	\$820	\$940
	7'0"	\$610	\$630	\$656	\$704	\$770	\$890	\$670	\$692	\$722	\$772	\$844	\$964
	7'2"	\$642	\$656	\$680	\$724	\$792	\$912	\$694	\$698	\$732	\$778	\$856	\$976
	8'0"	\$700	\$716	\$736	\$784	\$858	\$978	\$766	\$778	\$806	\$854	\$944	\$1,064
	9'0"	\$726	\$752	\$770	\$808	\$892	\$1,012	\$784	\$822	\$840	\$882	\$974	\$1,094
	10'0"	\$772	\$792	\$820	\$870	\$950	\$1,070	\$830	\$856	\$886	\$950	\$1,040	\$1,160

STEEL TYPES	
Cold rolled steel	Included
A60 Galvanized steel	\$56.00
G90 Galvanized steel (available in 14 and 16 gauge only)	\$102.00
12 Gauge - see <a href="#">Cut-N-Notch</a>	N/A

HINGE PREPARATIONS	
Special hinge locations	No charge
4-1/2" or 5" Universal hinge prep	No charge
Additional hinge prep (per hinge)	\$23.00
Electric hinge <ul style="list-style-type: none"> <li>▪ One 1/2" dia. hole in one hinge reinf.</li> <li>▪ No wiring included, no junction box</li> </ul>	\$22.00
Continuous hinge reinforcement (rabbet)	\$83.00
Power transfer (no junction box)	\$104.00

FRAME - STRIKE PREPARATIONS	
Surface vertical rod reinforcement only	\$30.00
Concealed vertical rod (mortise strike) (per prep)	\$69.00

CLOSER PREPARATIONS	
Closer reinforcement - 14 gauge plate - RA or PA	\$29.00
Full depth reinforcement (price per foot)	\$32.00
Concealed overhead door closer, holder or stop	\$289.00
Allegion Concealed overhead door closer, holder or stop	\$262.00

SPECIAL CONSTRUCTIONS	
Special width (use next larger size)	No charge
Special height (use next larger size)	No charge
Mag switch/DPS - Hole only	\$22.00
Mag switch/DPS - Prep and reinf. (no junction box)	\$90.00
8" Junction box welded in	\$33.00
10" Junction box welded in soffit	\$33.00
14" Junction box welded in	\$33.00

LABEL PREPARATIONS	
Mark numbers	No charge
U.L. Emboss (must specify)	No charge
U.L. Mylar label (standard unless specified otherwise)	\$22.00
U.L. Metal label	\$29.00
ITS/Warnock Hersey Metal label	\$29.00

Note: Fire rating - max depth 14". Heads will have anchors welded in.

SPECIAL FINISH PREPARATIONS	
Second coat of primer	\$109.00
Finish paint setup charge (never waived)	\$1,350.00
Finish paint <ul style="list-style-type: none"> <li>▪ Minimum quantity of 20 frames per color</li> <li>▪ Price includes full carton wrap</li> </ul>	\$274.00

Note: Finish paint unavailable on welded frames.

ANCHOR OPTIONS	
Welded in prepared opening anchor (per anchor)	\$16.00
Welded in anchor (per anchor)	\$7.00
Punch and dimple only (per prep)	\$5.50

Note: Frames up to 7'0 quantity of anchors - 6 (max 8-3/4" depth).  
 Frames over 7'0 thru 10'0 quantity of anchors - 8 (max 8-3/4" depth).  
 Frames over 8-3/4" depth receive double anchor quantity.

FRAME CONSTRUCTION	
Unit bundle (3pc)	\$7.00
Standard face weld (3pc)	\$116.00
Full profile weld (3pc)	\$208.00

FRAME PROFILE OPTIONS	
No returns	No charge
Non-standard face - see <a href="#">Cut-N-Notch</a> section	N/A
2" Face	No charge

See [Engineering Section](#) for further options and/or details.

## MH SERIES

### Double egress

refer to technical data sheet on page 12

- Double Egress Openings are designed to permit the flow of traffic in two directions through the same opening
- Face – 2"
- Universal Standard/Heavy Weight Hinge – Frames for 1-3/4" doors shall have a 7 gauge steel hinge reinforcement plate, projection welded with provisions for 4-1/2" x 4-1/2" template hinges.
- Hinge plate is designed to be modified to accept a heavy weight hinge by removing spacer plate.
- Hinge Backset – 5/16"
- Backbend – 1/2" (Double Return)

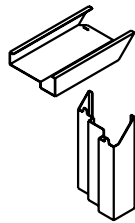
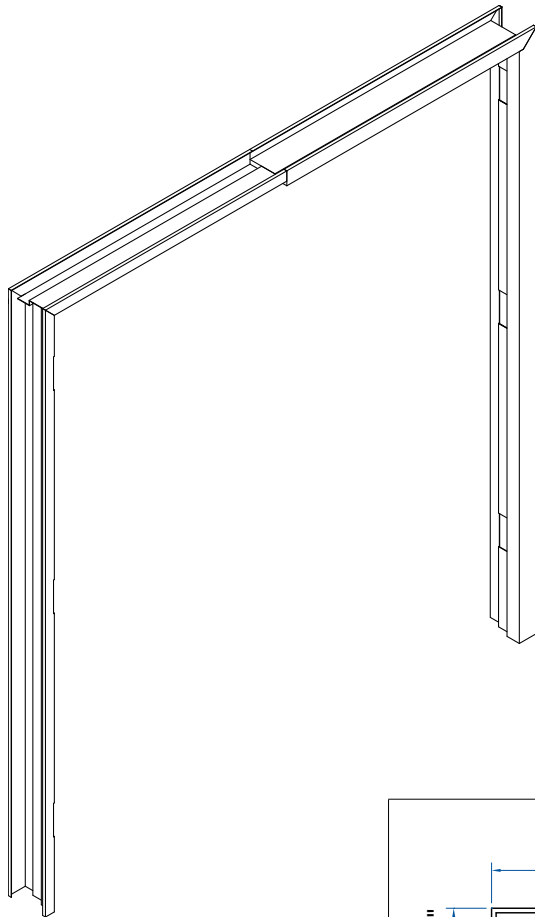

Double Egress Corner

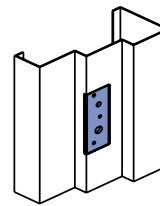

Double Egress Hinge

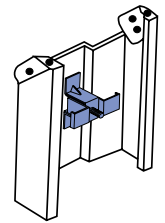

Compression Anchor (Standard)

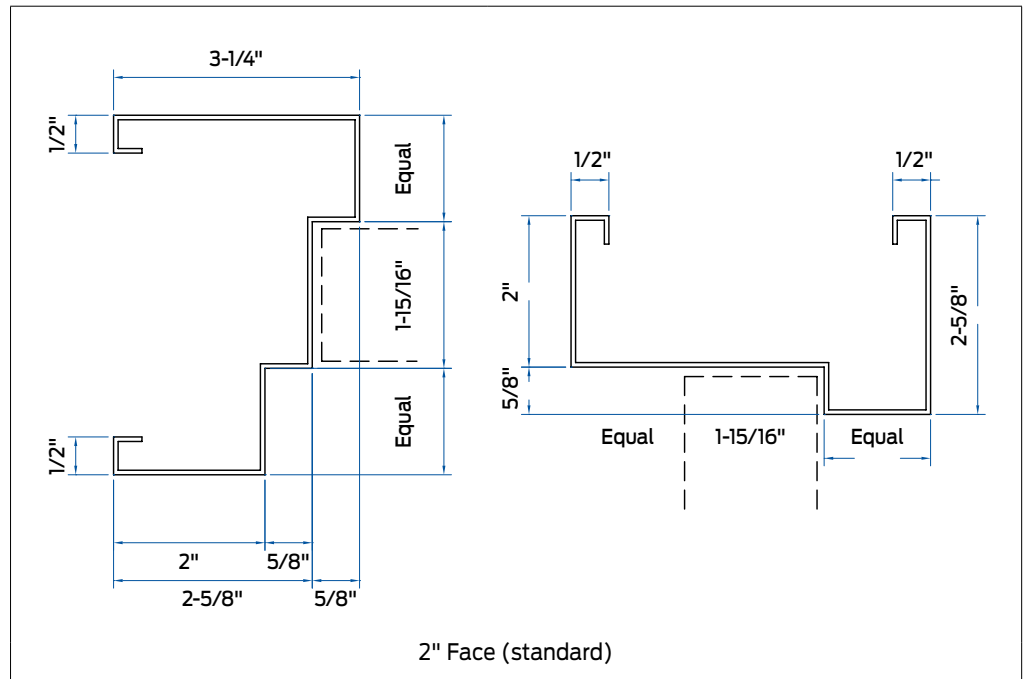
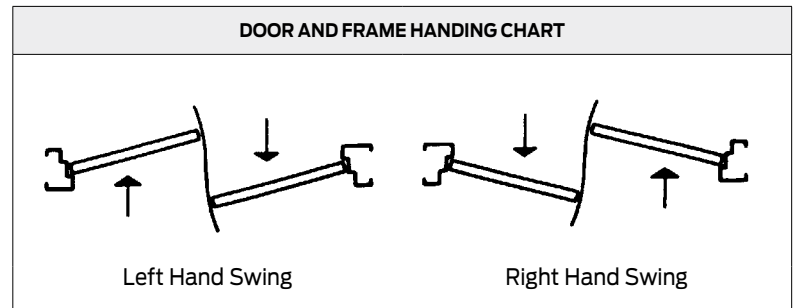

<b>Rough Opening Required for DW Double Egress Frame Based on (1) compression anchor located on door rabbit (per jamb)</b>
Door width opening + 3"
Door height opening + 1"

FRAMES 1/2" DOUBLE RETURN X 2" FACE X COMPRESSION ANCHORS													
Width	Height	16 Gauge						14 Gauge					
		4-1/2" thru 5-7/8"	6" thru 7-7/8"	8" thru 9-7/8"	10" thru 11-7/8"	12" thru 14-3/4"	14-7/8" thru 20"	4-1/2" thru 5-7/8"	6" thru 7-7/8"	8" thru 9-7/8"	10" thru 11-7/8"	12" thru 14-3/4"	14-7/8" thru 20"
Thru 6'0"	6'8"	\$1,027	\$1,081	\$1,131	\$1,185	\$1,308	\$1,466	\$1,177	\$1,241	\$1,272	\$1,362	\$1,462	\$1,609
	7'0"	\$1,035	\$1,085	\$1,140	\$1,204	\$1,317	\$1,476	\$1,195	\$1,263	\$1,292	\$1,369	\$1,478	\$1,641
	7'2"	\$1,068	\$1,112	\$1,169	\$1,230	\$1,346	\$1,513	\$1,214	\$1,278	\$1,301	\$1,369	\$1,488	\$1,650
	8'0"	\$1,132	\$1,177	\$1,228	\$1,285	\$1,412	\$1,566	\$1,305	\$1,367	\$1,394	\$1,459	\$1,593	\$1,735
	9'0"	\$1,160	\$1,220	\$1,257	\$1,323	\$1,444	\$1,611	\$1,319	\$1,406	\$1,432	\$1,496	\$1,621	\$1,787
	10'0"	\$1,207	\$1,267	\$1,323	\$1,387	\$1,513	\$1,668	\$1,376	\$1,460	\$1,492	\$1,571	\$1,699	\$1,852
Over 6'0" – 8'0"	6'8"	\$1,063	\$1,122	\$1,173	\$1,225	\$1,343	\$1,514	\$1,209	\$1,276	\$1,315	\$1,407	\$1,503	\$1,657
	7'0"	\$1,071	\$1,126	\$1,182	\$1,244	\$1,352	\$1,524	\$1,227	\$1,298	\$1,335	\$1,414	\$1,519	\$1,689
	7'2"	\$1,104	\$1,153	\$1,211	\$1,270	\$1,381	\$1,561	\$1,246	\$1,313	\$1,344	\$1,414	\$1,529	\$1,698
	8'0"	\$1,168	\$1,218	\$1,270	\$1,325	\$1,447	\$1,614	\$1,337	\$1,402	\$1,437	\$1,504	\$1,634	\$1,783
	9'0"	\$1,196	\$1,261	\$1,299	\$1,363	\$1,479	\$1,659	\$1,351	\$1,441	\$1,475	\$1,541	\$1,662	\$1,835
	10'0"	\$1,243	\$1,308	\$1,365	\$1,427	\$1,548	\$1,716	\$1,408	\$1,495	\$1,535	\$1,616	\$1,740	\$1,900
Over 8'0" – 9'0"	6'8"	\$1,081	\$1,152	\$1,202	\$1,242	\$1,370	\$1,537	\$1,242	\$1,316	\$1,347	\$1,428	\$1,534	\$1,696
	7'0"	\$1,089	\$1,156	\$1,211	\$1,261	\$1,379	\$1,547	\$1,260	\$1,338	\$1,367	\$1,435	\$1,550	\$1,728
	7'2"	\$1,122	\$1,183	\$1,240	\$1,287	\$1,408	\$1,584	\$1,279	\$1,353	\$1,376	\$1,435	\$1,560	\$1,737
	8'0"	\$1,186	\$1,248	\$1,299	\$1,342	\$1,474	\$1,637	\$1,370	\$1,442	\$1,469	\$1,525	\$1,665	\$1,822
	9'0"	\$1,214	\$1,291	\$1,328	\$1,380	\$1,506	\$1,682	\$1,384	\$1,481	\$1,507	\$1,562	\$1,693	\$1,874
	10'0"	\$1,261	\$1,338	\$1,394	\$1,444	\$1,575	\$1,739	\$1,441	\$1,535	\$1,567	\$1,637	\$1,771	\$1,939
Over 9'0" – 10'0"	6'8"	\$1,146	\$1,233	\$1,289	\$1,327	\$1,459	\$1,630	\$1,320	\$1,416	\$1,451	\$1,537	\$1,642	\$1,807
	7'0"	\$1,154	\$1,237	\$1,298	\$1,346	\$1,468	\$1,640	\$1,338	\$1,438	\$1,471	\$1,544	\$1,658	\$1,839
	7'2"	\$1,187	\$1,264	\$1,327	\$1,372	\$1,497	\$1,677	\$1,357	\$1,453	\$1,480	\$1,544	\$1,668	\$1,848
	8'0"	\$1,251	\$1,329	\$1,386	\$1,427	\$1,563	\$1,730	\$1,448	\$1,542	\$1,573	\$1,634	\$1,773	\$1,933
	9'0"	\$1,279	\$1,372	\$1,415	\$1,465	\$1,595	\$1,775	\$1,462	\$1,581	\$1,611	\$1,671	\$1,801	\$1,985
	10'0"	\$1,326	\$1,419	\$1,481	\$1,529	\$1,664	\$1,832	\$1,519	\$1,635	\$1,671	\$1,746	\$1,879	\$2,050

COMPONENT FRAMES 1/2" DOUBLE RETURN X 2" FACE X COMPRESSION ANCHORS													
Heads		16 Gauge						14 Gauge					
	Width	4-1/2" thru 5-7/8"	6" thru 7-7/8"	8" thru 9-7/8"	10" thru 11-7/8"	12" thru 14-3/4"	14-7/8" thru 20"	4-1/2" thru 5-7/8"	6" thru 7-7/8"	8" thru 9-7/8"	10" thru 11-7/8"	12" thru 14-3/4"	14-7/8" thru 20"
DBL Head	Thru 6'0"	\$357	\$372	\$390	\$412	\$453	\$501	\$416	\$435	\$439	\$464	\$496	\$547
	Over 6'0" – 8'0"	\$393	\$413	\$432	\$452	\$488	\$549	\$448	\$470	\$482	\$509	\$537	\$595
	Over 8'0" – 9'0"	\$411	\$443	\$461	\$469	\$515	\$572	\$481	\$510	\$514	\$530	\$568	\$634
	Over 9'0" – 10'0"	\$476	\$524	\$548	\$554	\$604	\$665	\$559	\$610	\$618	\$639	\$676	\$745

COMPONENT FRAMES 1/2" DOUBLE RETURN X 2" FACE X COMPRESSION ANCHORS													
Jamb Pair		16 Gauge						14 Gauge					
	Height	4-1/2" thru 5-7/8"	6" thru 7-7/8"	8" thru 9-7/8"	10" thru 11-7/8"	12" thru 14-3/4"	14-7/8" thru 20"	4-1/2" thru 5-7/8"	6" thru 7-7/8"	8" thru 9-7/8"	10" thru 11-7/8"	12" thru 14-3/4"	14-7/8" thru 20"
DBL Pair	6'8"	\$670	\$709	\$741	\$773	\$855	\$965	\$761	\$806	\$833	\$898	\$966	\$1,062
	7'0"	\$678	\$713	\$750	\$792	\$864	\$975	\$779	\$828	\$853	\$905	\$982	\$1,094
	7'2"	\$711	\$740	\$779	\$818	\$893	\$1,012	\$798	\$843	\$862	\$905	\$992	\$1,103
	8'0"	\$775	\$805	\$838	\$873	\$959	\$1,065	\$889	\$932	\$955	\$995	\$1,097	\$1,188
	9'0"	\$803	\$848	\$867	\$911	\$991	\$1,110	\$903	\$971	\$993	\$1,032	\$1,125	\$1,240
	10'0"	\$850	\$895	\$933	\$975	\$1,060	\$1,167	\$960	\$1,025	\$1,053	\$1,107	\$1,203	\$1,305

STEEL TYPES	
Cold rolled steel	Included
A60 Galvanized steel	\$56.00
G90 Galvanized steel (available in 14 and 16 gauge only)	\$102.00
12 Gauge (N/A on drywall frame)	N/A

HINGE PREPARATIONS	
Special hinge locations	No charge
4-1/2" or 5" Universal hinge prep	No charge
Additional hinge prep (per hinge)	\$23.00
Electric hinge <ul style="list-style-type: none"> <li>▪ One 1/2" dia. hole in one hinge reinf.</li> <li>▪ No wiring included, no junction box</li> </ul>	\$22.00
Continuous hinge reinforcement (rabbet)	\$83.00
Power transfer (no junction box)	\$104.00

FRAME - STRIKE PREPARATIONS	
Surface vertical rod reinforcement only	\$30.00
Concealed vertical rod (mortise strike) (per prep)	\$69.00

CLOSER PREPARATIONS	
Closer reinforcement - 14 gauge plate - RA or PA	\$29.00
Full depth reinforcement (price per foot)	\$32.00
Concealed overhead door closer, holder or stop	\$289.00
Allegion Concealed overhead door closer, holder or stop	\$262.00

SPECIAL CONSTRUCTIONS	
Special width (use next larger size)	No charge
Special height (use next larger size)	No charge
Mag switch/DPS - Hole only	\$22.00
Mag switch/DPS - Prep and reinf. (no junction box)	\$90.00
8" Junction box welded in	\$33.00
14" Junction box welded in	\$33.00
10" Junction box welded in soffit	\$33.00

LABEL PREPARATIONS	
Mark numbers	No charge
U.L. Emboss (must specify)	N/A
U.L. Mylar label (standard unless specified otherwise)	N/A
U.L. Metal label	N/A
ITS/Warnock Hersey Metal label	N/A

Note: Fire rating not available.

SPECIAL FINISH PREPARATIONS	
Second coat of primer	\$109.00
Finish paint setup charge (never waived)	\$1,350.00
Finish paint <ul style="list-style-type: none"> <li>▪ Minimum quantity of 20 frames per color</li> <li>▪ Price includes full carton wrap</li> </ul>	\$274.00

Note: Finish paint unavailable on welded frames.

ANCHOR OPTIONS	
Welded in prepared opening anchor (per anchor)	\$16.00
Welded in anchor (per anchor)	\$7.00
Punch and dimple only (per prep)	\$5.50

Note: Frames up to 7'0 quantity of anchors - 6 (max 8-3/4" depth).  
 Frames over 7'0 thru 10'0 quantity of anchors - 8 (max 8-3/4" depth).  
 Frames over 8-3/4" depth receive double anchor quantity.

FRAME CONSTRUCTION	
Unit bundle (3pc)	\$7.00
Standard face weld (3pc) (omit compression anchor)	\$116.00
Full face weld (3pc) (omit compression anchor)	\$208.00

FRAME PROFILE OPTIONS	
No returns	No charge
Non-standard face - see <a href="#">Cut-N-Notch</a>	N/A
2" Face	No charge

See [Engineering Section](#) for further options and/or details.



### LEAD LINED DOORS AND FRAMES

#### Specialty

refer to technical data sheet on page 14

Typical construction based on DL Series door

#### DOOR

- Lead Thickness – 1/16" standard
- Edge Seam Construction – Visible seam
- Thickness – 1-3/4"
- Actual Door Size – Door undersized from nominal by 1/4" in width and 7/8" in height. Standard undercut is 3/4".
- Hinge Rail and Reinforcement – Hinge edge is non-beveled and reinforced with a continuous 10 or 16 gauge steel channel projection welded at a maximum 5" on center
- Lock Rail – Lock edge is non-beveled and reinforced with a continuous 16 or 14 gauge steel channel projection welded at a maximum 5" on center. (Beveled lock edge 1/8" in 2" optional.)
- Top Channel – Top Channel is a flush 16 gauge steel channel, projection welded at a maximum 2-1/2" on center
- Bottom Channel – Bottom Channel is an inverted 16 gauge steel channel, projection welded at a maximum 2-1/2" on center
- Cores Available – Steel Stiffened core
- Face Skins – Cold rolled steel or Galvannealed, 18 gauge, 16 gauge or 14 gauge
- Closer Reinforcement (Optional) – When closer reinforcement requested 14 gauge standard/12 gauge optional. (18" x 6")
- Size Availability
  - Maximum 4'10" x 10'0" (Singles)
  - Maximum 9'8" x 10'0" (Pairs)
- SDI 100 Level/Model – Level 2-4 Model 1 (Maximum Duty Performance Level A and B)
- Universal Standard/Heavy Weight Hinge – Hinge fillers are used allowing for an easy modification from standard to heavy weight hinge prep
- Handing Design – Non-Handed standard (Handed optional)

#### FRAME

- Thickness – Made for standard door 1-3/4"
- Gauges – 16 or 14 (12 gauge available with coped corner condition for welding)
- Faces – 2" standard
- Standard Rabbets
  - 1-3/8" (actual dimension 1-9/16")
  - 1-3/4" (actual dimension 1-15/16")
  - Rabbet dimension is 3/16" greater than the door thickness.
- Stop – 5/8" standard
- Closer Reinforcement (Optional) – 1-3/8" x 14" x 14 gauge plate
- Size Availability
  - Maximum Size 4'10" x 10'0" Single
  - Maximum Size 9'8" x 10'0" Double
- Universal Standard/Heavy Weight Hinge – Frames for 1-3/4" doors shall have a 7 gauge steel hinge reinforcement plate, projection welded with provisions for 4-1/2" x 4-1/2" template hinges. Hinge plate is designed to be modified to accept a heavy weight hinge by removing spacer plate.
- Strike Prep – Frames for 1-3/4" doors shall have a 14 gauge steel strike reinforcement plate, extruded and formed to the equivalent of 10 gauge, projection welded with provisions for Universal ANSI A115.1 or ANSI A115.2 strike (4-7/8")
- Hinge Backset
  - Frame = 5/16"
  - Door = 1/4"

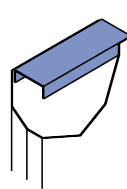
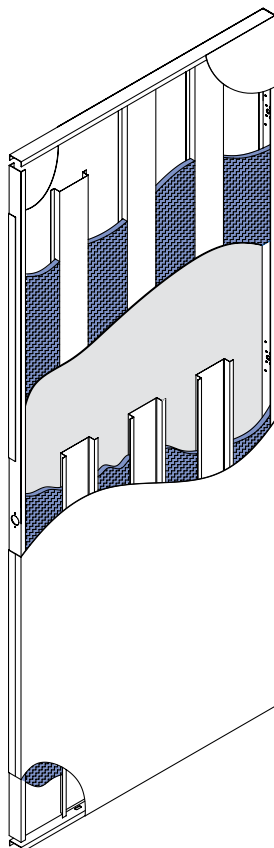

Flush Top

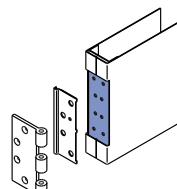

Door Hinge Prep

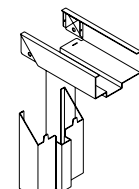

Corner Connection

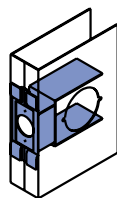

Cylindrical Lock Prep

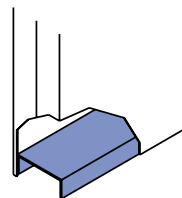

Inverted Bottom Channel

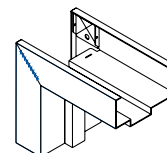

Welded Corner Connection

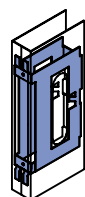

Mortise Lock Prep

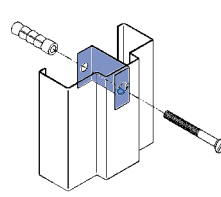

Prepared Opening Anchor

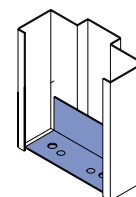

Standard Sill Anchor

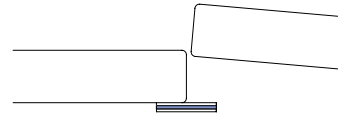
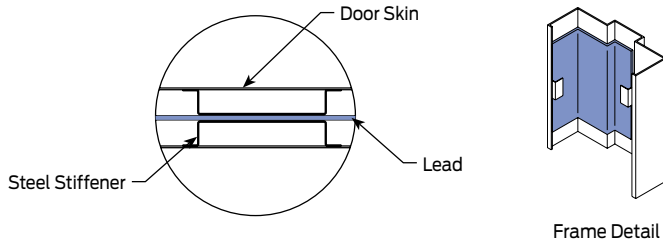

Lead-Line Astragal required on pairs

### Doors

1/16" THICK LEAD WITH 20 GA STIFFENERS				
Width	Height	18 GA	16 GA	14 GA
Thru 3'0"	Thru 7'0"	\$5,976	\$6,131	\$6,704
	Thru 8'0"	\$6,286	\$6,493	\$7,023
	Thru 10'0"	\$8,063	\$8,180	\$8,695
Over 3'0" – 4'0"	Thru 7'0"	\$6,299	\$6,507	\$7,037
	Thru 8'0"	\$6,537	\$6,787	\$7,275
	Thru 10'0"	\$10,179	\$10,342	\$10,957
Over 4'0" – 4'10"	Thru 7'0"	N/A	\$9,168	\$10,168
	Thru 8'0"	N/A	\$9,447	\$10,509
	Thru 10'0"	N/A	\$18,065	\$19,353

14/16 Gauge doors over 4'0 available in Galv only.

LEAD OPTIONS		
Description	Door	Frame
1/16" Lead	Included	Included

STEEL TYPES		
Description	Door	Frame
Cold rolled steel	Included	Included
A60 Galvanized steel	\$105.00	\$56.00
G90 Galvanized steel (14 and 16 gauge only)	\$419.00	\$102.00

LABEL PREPARATIONS		
Description	Door	Frame
Mark numbers	No charge	No charge
U.L. Mylar label (standard unless specified otherwise)	N/A	N/A
U.L. Metal label	N/A	N/A
Warnock Hersey Metal label	N/A	N/A

**NOTES:**  
 Frames are priced as Equal or Unequal rabbet.  
 Frames 3"–4-1/2" Jamb depth must be single rabbet.  
 For Borrowed Lite, Side Lite, and Elevation Pricing, see [Cut-N-Notch Section](#).

### Frames

SINGLE OR DOUBLE RETURN - 16 GAUGE					
Single Frame		Jamb Depth			
Width	Height	4-5/8" thru 5-3/4"	5-7/8" thru 8-3/4"	8-7/8" thru 14-3/4"	14-7/8" thru 20"
Thru 3'0"	Thru 7'0"	\$4,736	\$4,841	\$4,956	\$5,099
	Thru 8'0"	\$4,813	\$4,905	\$5,020	\$5,175
	Thru 10'0"	\$4,990	\$5,135	\$5,251	\$5,401
Over 3'0" – 4'0"	Thru 7'0"	\$4,751	\$4,850	\$4,966	\$5,119
	Thru 8'0"	\$4,829	\$4,913	\$5,029	\$5,182
	Thru 10'0"	\$5,005	\$5,141	\$5,260	\$5,412
Over 4'0" – 4'10"	Thru 7'0"	\$4,798	\$4,906	\$5,021	\$5,176
	Thru 8'0"	\$4,875	\$4,972	\$5,085	\$5,239
	Thru 10'0"	\$5,052	\$5,198	\$5,314	\$5,466
Double Frame		Jamb Depth			
Thru 6'0"	Thru 7'0"	\$4,816	\$4,949	\$5,061	\$5,215
	Thru 8'0"	\$4,907	\$5,029	\$5,142	\$5,295
	Thru 10'0"	\$5,126	\$5,265	\$5,379	\$5,532
Over 6'0" – 8'0"	Thru 7'0"	\$4,830	\$4,977	\$5,091	\$5,243
	Thru 8'0"	\$4,923	\$5,060	\$5,174	\$5,324
Over 8'0" – 9'8"	Thru 7'0"	\$5,141	\$5,295	\$5,408	\$5,561
	Thru 8'0"	\$4,879	\$5,053	\$5,171	\$5,322
	Thru 10'0"	\$4,973	\$5,137	\$5,251	\$5,401
Over 8'0" – 9'8"	Thru 8'0"	\$4,973	\$5,137	\$5,251	\$5,401
	Thru 10'0"	\$5,187	\$5,374	\$5,485	\$5,640

SINGLE OR DOUBLE RETURN - 14 GAUGE					
Single Frame		Jamb Depth			
Width	Height	4-5/8" thru 5-3/4"	5-7/8" thru 8-3/4"	8-7/8" thru 14-3/4"	14-7/8" thru 20"
Thru 3'0"	Thru 7'0"	\$4,813	\$4,951	\$5,083	\$5,234
	Thru 8'0"	\$4,901	\$5,025	\$5,156	\$5,310
	Thru 10'0"	\$5,103	\$5,274	\$5,404	\$5,559
Over 3'0" – 4'0"	Thru 7'0"	\$4,830	\$4,966	\$5,091	\$5,243
	Thru 8'0"	\$4,919	\$5,040	\$5,162	\$5,316
	Thru 10'0"	\$5,119	\$5,289	\$5,413	\$5,566
Over 4'0" – 4'10"	Thru 7'0"	\$4,906	\$5,039	\$5,155	\$5,308
	Thru 8'0"	\$4,966	\$5,115	\$5,240	\$5,395
	Thru 10'0"	\$5,195	\$5,395	\$5,491	\$5,644
Double Frame		Jamb Depth			
Thru 6'0"	Thru 7'0"	\$4,937	\$5,089	\$5,215	\$5,366
	Thru 8'0"	\$5,038	\$5,178	\$5,306	\$5,456
	Thru 10'0"	\$5,275	\$5,431	\$5,556	\$5,705
Over 6'0" – 8'0"	Thru 7'0"	\$4,954	\$5,119	\$5,243	\$5,397
	Thru 8'0"	\$5,059	\$5,210	\$5,331	\$5,484
Over 8'0" – 9'8"	Thru 7'0"	\$5,295	\$5,462	\$5,581	\$5,737
	Thru 8'0"	\$5,005	\$5,205	\$5,327	\$5,481
	Thru 10'0"	\$5,108	\$5,294	\$5,418	\$5,570
Over 8'0" – 9'8"	Thru 8'0"	\$5,108	\$5,294	\$5,418	\$5,570
	Thru 10'0"	\$5,346	\$5,546	\$5,667	\$5,822

HINGE PREPARATIONS		
Description	Door	Frame
Special hinge locations	No charge	No charge
4-1/2" or 5" Universal hinge prep	No charge	No charge
Additional hinge prep (per hinge)	\$25.00	\$23.00
4" Template hinge prep (square corner only) (per hinge)	\$58.00	\$58.00
Anchor hinge prep (no drilling or tapping)	\$488.00	\$287.00
Electric hinge <ul style="list-style-type: none"> <li>Cutout in one hinge reinf.</li> <li>No junction box or conduit</li> </ul>	\$25.00	\$22.00
Continuous hinge reinforcement	\$88.00	\$83.00
Power transfer <ul style="list-style-type: none"> <li>Cutout and reinf.</li> <li>No junction box or conduit</li> </ul>	\$131.00	\$104.00
8" Junction box welded in	N/A	\$33.00
10" Junction box welded in soffit	N/A	\$33.00
14" Junction box welded in	N/A	\$33.00

PIVOT OPTIONS		
Description	Door	Frame
Center hung - per prep (no drilling or tapping) (N/A for intermediate and offset pivots)	\$354.00	\$108.00
Rescue hardware prep - one pivot (no drilling or tapping) and emergency stop	N/A	\$287.00
Double lipped strike	N/A	\$144.00
Pocket pivot - per prep	\$194.00	\$163.00

DOOR - LOCK/FRAME - STRIKE PREPARATIONS		
Description	Door	Frame
Standard lock (strike) at non-standard location	No charge	No charge
Cylindrical dead lock (2-3/4" strike)	\$61.00	\$23.00
Mortise dead lock (3-1/2" strike)	\$61.00	\$23.00
Electric strike (no junction box or conduit)	\$135.00	\$68.00
ASA Strike	\$59.00	Included
Rim reinforcement only	\$50.00	\$30.00
Rim reinforcement with function prep	\$56.00	N/A
Mortise exit device reinforcement with function prep	\$89.00	N/A
Surface vertical rod reinforcement only	\$82.00	\$30.00
Concealed vertical rod (strike) per prep	\$611.00	N/A
Exit alarm reinforcement only	\$62.00	\$30.00
Push pull reinforcement	\$40.00	N/A

CLOSER PREPARATIONS		
Description	Door	Frame
Closer reinforcement (frame 14 gauge plate)	\$37.00	\$29.00
Concealed overhead door closer, holder or stop	\$371.00	\$289.00

SPECIAL CONSTRUCTIONS		
Description	Door	Frame
Undercut - under 3/8" price next larger size	No charge	N/A
Inverted top channel	No charge	N/A
Flush bottom channel	No charge	N/A
Seal top or bottom channel and finish smooth each	\$142.00	N/A
Mag switch/DPS - Hole only	\$23.00	\$22.00
Mag switch/DPS - Prep and reinf. (no junction box)	\$123.00	\$90.00
Continuous welded edge (N/A in 20 gauge)	\$169.00	N/A
Bondo filled edge	\$115.00	N/A
Beveled lock edge (1/8" in 2") N/A in 14 gauge and inactive leafs with strike(s)	\$23.00	N/A
10 Gauge hinge and 14 gauge lock channels (DE Series - standard on 14 gauge door)	\$156.00	N/A
Automatic door bottom (mortise type)	\$225.00	N/A
Conduit/raceway - includes wire pull	\$190.00	N/A

SPECIAL FINISH PREPARATIONS		
Description	Door	Frame
Second coat of primer	N/A	N/A
Finish paint setup charge (never waived)	N/A	N/A
Finish paint <ul style="list-style-type: none"> <li>Minimum quantity of 20 door or frame units</li> <li>Price includes full carton wrap</li> </ul>	N/A	N/A

ANCHOR OPTIONS		
Description	Door	Frame
Welded in prepared opening anchor (per anchor)	N/A	\$16.00
Welded in anchor (per anchor)	N/A	\$7.00
Punch and dimple only (per prep)	N/A	\$5.50

FRAME CONSTRUCTION		
Description	Door	Frame
Unit bundle (3pc)	N/A	\$7.00
Standard face weld (3pc)	N/A	\$116.00
Full profile weld (3pc)	N/A	\$208.00



FRAME PROFILE OPTIONS		
Description	Door	Frame
Single rabbet	N/A	No charge
4" Face heads (through 4'0")	N/A	\$59.00
4" Face heads (over 4'0")	N/A	\$83.00
Non-standard face (per frame) (equal faces)	N/A	\$65.00

DOUBLE SWING PREPARATIONS		
Description	Door	Frame
Attaching astragal (includes astragal lead-lined)	\$722.00	N/A
Flush bolt prep (ANSI 115.4)	\$95.00	\$59.00
Surface bolt reinforce only	\$36.00	\$30.00
Open back strike	\$161.00	N/A

GLASS KIT OPTIONS			
	Vision/ Narrow Lite up to 100 inch <sup>2</sup>	Half Glass over 100 inch <sup>2</sup> up to 800 inch <sup>2</sup>	Full Glass over 800 inch <sup>2</sup>
Cutout with kit installed	\$231	\$274	N/A
Cutout with kit and reinf.	\$313	\$356	\$389
Sunburst kit (1/2" glass included)	\$560	N/A	N/A
Muntin bar (each)	\$150	\$150	\$150
Galvanized kit add	\$127	\$127	\$127
Glass pocket add (other than 1/4" )	\$209	\$209	\$209

Note: Prices are based on Republic standard lite kit (No glass unless noted otherwise). Contact customer service for lead-lined lite insert add.

CUTOUT ONLY OPTIONS (GLASS KITS AND LOUVERS)			
	Up to 100 inch <sup>2</sup>	Over 100 inch <sup>2</sup> up to 800 inch <sup>2</sup>	Over 800 inch <sup>2</sup>
Panel in place	N/A	N/A	N/A
Cutout only	N/A	N/A	N/A
Cutout with reinforcement	\$167	\$167	\$167

See [Engineering Section](#) for further options and/or details.



### BULLET RESISTANT DOORS AND FRAMES

#### Specialty

refer to technical data sheet on page 14

#### DOOR

- Door Thickness – 1-13/16" (+/- 1/16")
- Edge Seam Construction – Seamless
- Actual Door Size – Door undersized from nominal by 1/4" in width and 7/8" in height. Standard undercut is 3/4".
- Hinge Rail and Reinforcement – Hinge edge is non-beveled and reinforced with a continuous 10 gauge steel channel projection welded at a maximum 5" on center. (Backset 1/4")
- Lock Rail – Lock edge is non-beveled and reinforced with a continuous 14 gauge steel channel projection welded at a maximum 5" on center. 16 gauge reinforcements for mortise or cylindrical locks are of an integral type in accordance with ANSI A115 Standards.
- Top Channel – Top Channel is a flush 16 gauge channel, projection welded at a maximum 2-1/2" on center
- Bottom Channel – Bottom Channel is an inverted 16 gauge steel channel, projection welded at a maximum 2-1/2" on center
- Cores Available
  - Polystyrene Levels 1
  - Polystyrene with armor plating Levels 2-3
  - Mineral wool or fiberglass batting with armor plating Levels 4-8
- Face Skins – 14 gauge (cold rolled steel or A60 Galvannealed)
- Handing Design – Non-Handed (Handed optional)
- Closer Reinforcement (Optional) - Only available on Levels 1-3. Closer reinforcement not necessary on levels 4-8 due to plating in construction requirements.
- Size Availability
  - Minimum 1'0" x 1'0"
  - Maximum 4'10" x 10'0"
- SDI 100 Level/Model – Level 4 Model 2
- Universal Standard/Heavy Weight Hinge – Levels 1, 2, and 3 are prepped for (3) 4-1/2" or 5" butt hinges up to 3476 nominal size opening. Over 3476 and Levels 4-8 (all sizes) are prepped for (4) 4-1/2" or 5" butt hinges or continuous hinge application.

#### FRAME

- Frame Thickness – Made to accommodate 14 gauge door - 2" rabbet (+/- 1/16")
- Gauges – 14 gauge only
- Stop – 5/8" standard
- Closer Reinforcement (Optional) – 1-3/8" x 14" x 14 gauge plate
- Universal Standard/Heavy Weight Hinge – Frames shall have a 7 gauge steel hinge reinforcement plate, projection welded with provisions for 4-1/2" x 4-1/2" template hinges. Hinge plate is designed to be modified to accept a heavy weight hinge by removing spacer plate.
- Strike Prep – Frames shall have a 14 gauge steel strike reinforcement plate, extruded and formed to the equivalent of 10 gauge, projection welded with provisions for Universal ANSI A115.1 or ANSI A115.2 strike (4-7/8")
- Hinge Backset
  - Frame = 5/16"
  - Door = 1/4"
- Backbend – 7/16" (Single Return)
- Anchors – Level 1 only - Snap in universal anchor and masonry tee. All Levels - Masonry wire, Prepared Opening Anchors, and adjustable strap anchors.
- Double Heads – Double heads are undersized 1/16"
- Silencer Prep – 9/32" dia. holes shall be provided as standard on strike jambs and double headers, (3 per strike jamb and 2 per double head). Mutes are not supplied and must be ordered separately.
- Mortar Guards – Mortar guards of 26 gauge steel shall be welded to each hinge and strike reinforcement plate
- Profiles – Equal Rabbet, Unequal Rabbet
- Handing – Frames are handed

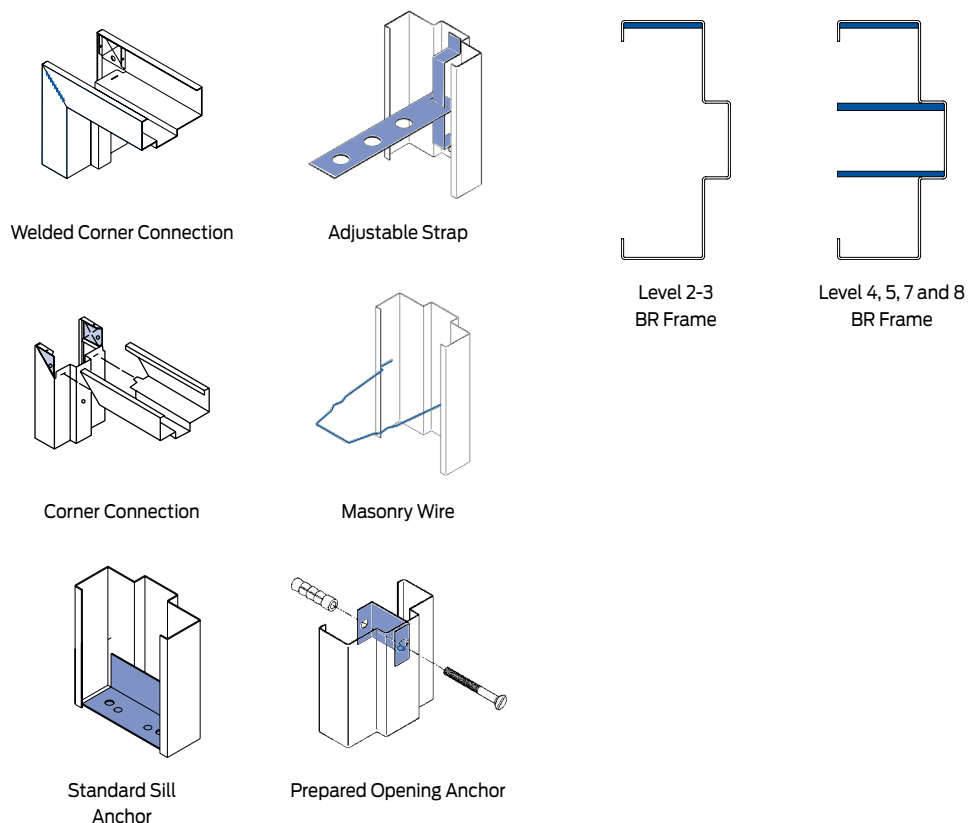
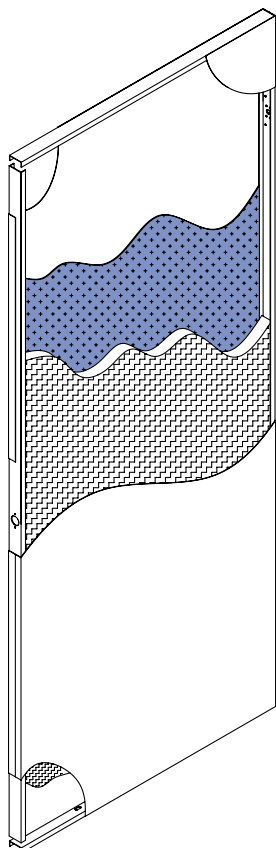

LEAD LINED

BULLET RESISTANT

DF SERIES

HURRICANE/WIND RESISTANT

SOUND TRANSMISSION CONTROL

Level	No. of Shots		Ammunition	Grain	Min. Velocity	Results
	Min. Req'd	Tested				
1	3	19	9mm full metal copper jacket	124	1,256 fps	Pass
2	3	19	.357 Magnum	125	1,250 fps	Pass
3	3	19	.44 Magnum lead semi-wad cutter gas checked	240	1,350 fps	Pass
4	1	19	.30 caliber rifle lead core	180	2,540 fps	Pass
5	1	5	7.62mm rifle full metal jacket military ball	150	2,750 fps	Pass
6	5	5	9mm full metal jacket	124	1,400 fps	Pass
7	5	12	5.56mm rifle full metal jacket	55	3,080 fps	Pass
8	5	12	7.62mm rifle full metal jacket military ball	150	2,750 fps	Pass
Supplementary Shotgun	3	3	12 ga. Rifled lead slug	437	1,585 fps	Pass
	3	3	12 ga. 00 lead buckshot (12 pellets)	650	1,200 fps	Pass

Note: Levels 4-8 – all hardware and anchoring must be reviewed, due to required construction.  
All door and frame assemblies tested in accordance with: UL 752-1995

SINGLES							
Level	Width	Height	Door	Frames - Single Return (14 Gauge)			
				5-3/4"	5-7/8" thru 8-3/4"	8-7/8" thru 14-3/4"	14-7/8" thru 20"
1	Thru 3'0"	7'0"	\$3,183	\$721	\$846	\$965	\$1,103
		8'0"	\$3,501	\$802	\$915	\$1,031	\$1,170
		10'0"	\$3,795	\$985	\$1,139	\$1,260	\$1,400
	Over 3'0" – 4'0"	7'0"	\$3,514	\$737	\$859	\$974	\$1,112
		8'0"	\$3,752	\$816	\$928	\$1,040	\$1,179
		10'0"	\$4,046	\$999	\$1,154	\$1,267	\$1,406
	Over 4'0" – 4'10"	7'0"	\$6,946	\$806	\$927	\$1,042	\$1,181
		8'0"	\$7,285	\$888	\$996	\$1,110	\$1,247
		10'0"	\$7,579	\$1,069	\$1,221	\$1,336	\$1,475
2-3	Thru 3'0"	7'0"	\$3,612	\$886	\$1,007	\$1,130	\$1,268
		8'0"	\$3,930	\$965	\$1,078	\$1,196	\$1,335
		10'0"	\$4,224	\$1,146	\$1,305	\$1,422	\$1,565
	Over 3'0" – 4'0"	7'0"	\$3,944	\$900	\$1,025	\$1,137	\$1,276
		8'0"	\$4,182	\$982	\$1,093	\$1,202	\$1,341
		10'0"	\$4,475	\$1,164	\$1,317	\$1,430	\$1,570
	Over 4'0" – 4'10"	7'0"	\$7,375	\$970	\$1,090	\$1,207	\$1,344
		8'0"	\$7,715	\$1,051	\$1,159	\$1,273	\$1,412
		10'0"	\$8,008	\$1,233	\$1,384	\$1,500	\$1,640
4 & 6	Thru 3'0"	7'0"	\$10,268	\$3,117	\$3,240	\$3,362	\$3,500
		8'0"	\$10,586	\$3,197	\$3,309	\$3,429	\$3,568
		10'0"	\$10,879	\$3,380	\$3,536	\$3,654	\$3,793
	Over 3'0" – 4'0"	7'0"	\$10,600	\$3,132	\$3,256	\$3,368	\$3,507
		8'0"	\$10,838	\$3,208	\$3,325	\$3,435	\$3,574
		10'0"	\$22,527	\$3,395	\$3,545	\$3,662	\$3,801
	Over 4'0" – 4'10"	7'0"	\$14,031	\$3,202	\$3,324	\$3,438	\$3,578
		8'0"	\$14,372	\$3,283	\$3,391	\$3,504	\$3,644
		10'0"	\$27,599	\$3,464	\$3,616	\$3,732	\$3,871

SINGLES							
Level	Width	Height	Door	Frames - Single Return (14 Gauge)			
				5-3/4"	5-7/8" thru 8-3/4"	8-7/8" thru 14-3/4"	14-7/8" thru 20"
5	Thru 3'0"	7'0"	\$11,342	\$3,117	\$3,240	\$3,362	\$3,500
		8'0"	\$11,661	\$3,197	\$3,309	\$3,429	\$3,568
		10'0"	\$16,307	\$3,380	\$3,536	\$3,654	\$3,793
	Over 3'0" – 4'0"	7'0"	\$11,674	\$3,132	\$3,256	\$3,368	\$3,507
		8'0"	\$11,912	\$3,208	\$3,325	\$3,435	\$3,574
		10'0"	\$22,527	\$3,395	\$3,548	\$3,662	\$3,801
	Over 4'0" – 4'10"	7'0"	\$15,105	\$3,202	\$3,324	\$3,438	\$3,578
		8'0"	\$15,445	\$3,283	\$3,391	\$3,504	\$3,644
		10'0"	\$27,599	\$3,464	\$3,616	\$3,732	\$3,871
7-8	Thru 3'0"	7'0"	\$16,710	\$3,117	\$3,240	\$3,362	\$3,500
		8'0"	\$17,028	\$3,197	\$3,309	\$3,429	\$3,568
		10'0"	\$19,567	\$3,380	\$3,536	\$3,654	\$3,793
	Over 3'0" – 4'0"	7'0"	\$17,042	\$3,132	\$3,256	\$3,368	\$3,507
		8'0"	\$17,280	\$3,208	\$3,325	\$3,435	\$3,574
		10'0"	\$22,527	\$3,395	\$3,548	\$3,662	\$3,801
	Over 4'0" – 4'10"	7'0"	\$20,472	\$3,202	\$3,324	\$3,438	\$3,578
		8'0"	\$20,813	\$3,283	\$3,391	\$3,504	\$3,644
		10'0"	\$27,599	\$3,464	\$3,616	\$3,732	\$3,871

Note: Levels 4-8 – all hardware and anchoring must be reviewed, due to required construction. 14 gauge doors over 4'0 available in GALV only.

LEAD LINED

BULLET RESISTANT

DF SERIES

HURRICANE/WIND RESISTANT

SOUND TRANSMISSION CONTROL

DOUBLES						
Level	Width	Height	Frames - Single Or Double Return 14 Gauge			
			5-3/4"	5-7/8" thru 8-3/4"	8-7/8" thru 14-3/4"	14-7/8" thru 20"
1	Thru 6'0"	7'0"	\$823	\$949	\$1,067	\$1,206
		8'0"	\$915	\$1,031	\$1,144	\$1,284
		10'0"	\$1,131	\$1,262	\$1,375	\$1,514
	Over 6'0"-8'0"	7'0"	\$832	\$971	\$1,087	\$1,225
		8'0"	\$926	\$1,053	\$1,166	\$1,306
		10'0"	\$1,141	\$1,282	\$1,395	\$1,533
	Over 8'0"-10'0"	7'0"	\$851	\$999	\$1,112	\$1,250
		8'0"	\$943	\$1,080	\$1,192	\$1,332
		10'0"	\$1,160	\$1,310	\$1,421	\$1,559
2-3	Thru 6'0"	7'0"	\$986	\$1,114	\$1,229	\$1,368
		8'0"	\$1,078	\$1,196	\$1,310	\$1,449
		10'0"	\$1,294	\$1,423	\$1,538	\$1,677
	Over 6'0"-8'0"	7'0"	\$997	\$1,136	\$1,249	\$1,387
		8'0"	\$1,089	\$1,218	\$1,331	\$1,470
		10'0"	\$1,306	\$1,446	\$1,558	\$1,697
	Over 8'0"-10'0"	7'0"	\$1,015	\$1,164	\$1,393	\$1,416
		8'0"	\$1,109	\$1,245	\$1,473	\$1,496
		10'0"	\$1,323	\$1,473	\$1,703	\$1,724

Note: Doubles available up to Level 3 maximum.  
Frames are priced 14 gauge, CRS. Doors are priced 14 gauge, CRS.

STEEL TYPES		
Description	Door	Frame
Cold rolled steel	Included	Included
A60 Galvanized steel	\$105.00	\$56.00
G90 Galvanized steel (14 and 16 gauge only)	\$419.00	\$102.00

HINGE PREPARATIONS		
Description	Door	Frame
Special hinge locations	No charge	No charge
4-1/2" or 5" Universal hinge prep	No charge	No charge
Additional hinge prep (per hinge)	\$25.00	\$23.00
4" Template hinge prep (square corner only) (per hinge)	N/A	N/A
Anchor hinge prep (no drilling or tapping) (per hinge) (Level 1 only)	\$488.00	\$287.00
Electric hinge (Levels 1-3 only) <ul style="list-style-type: none"> <li>Cutout in one hinge reinf.</li> <li>No junction box or conduit</li> </ul>	\$25.00	\$22.00
Continuous hinge reinforcement (Levels 1-3 only)	\$88.00	\$83.00
Power transfer (no junction box or conduit)	\$131.00	\$104.00
8" Junction box welded in (Level 1 only)	N/A	\$33.00
14" Junction box welded in (Level 1 only)	N/A	\$33.00
10" Junction box welded in soffit	N/A	\$33.00

DOOR - LOCK/FRAME - STRIKE PREPARATIONS		
Description	Door	Frame
Standard lock (strike) at non-standard location	No charge	No charge
2-3/4" Lipped strike in lieu of 4-7/8"	N/A	No charge
Cylindrical dead lock (2-3/4" strike)	\$61.00	\$23.00
Mortise dead lock (3-1/2" strike)	\$61.00	\$23.00
Electric strike (no conduit/no junction box) (Level 1)	\$135.00	\$68.00
ASA Strike	\$59.00	No charge
Rim reinforcement only	\$50.00	\$30.00
Surface vertical rod reinforcement only (Levels 1-3, Levels 4-8 N/A built in)	\$82.00	\$30.00
Concealed vertical rod (strike) (per prep) (Level 1)	\$611.00	N/A
Exit alarm reinforcement only (Levels 1-3, Levels 4-8 N/A built in)	\$62.00	\$30.00
Push pull reinforcement (Levels 1-3, Levels 4-8 N/A built in)	\$40.00	N/A

CLOSER PREPARATIONS		
Description	Door	Frame
Closer reinforcement (Level 1-3, Levels 4-8 N/A built in)	\$37.00	\$29.00

SPECIAL CONSTRUCTIONS		
Description	Door	Frame
Undercut - under 3/8" price next larger size	No charge	N/A
Inverted top channel (Levels 1-3 only)	No charge	N/A
Flush bottom channel (Levels 1-3 only)	No charge	N/A
Seal top or bottom channel and finish smooth each	\$142.00	N/A
Continuous welded edge	\$169.00	N/A
Bondo filled edge (included)	N/A	N/A
Beveled lock edge (1/8" in 2") N/A in 14 gauge and inactive leafs with strike(s)	N/A	N/A
10 Gauge Hinge and 14 Gauge Lock Channels (DE Series - standard on 14 gauge door)	Included	N/A
Mail slot	N/A	N/A
Automatic door bottom (mortise type) (Level 1 only)	\$225.00	N/A
Mag switch/DPS - Hole only (Levels 1-3 only)	\$23.00	\$22.00
Mag switch/DPS Mortise prep and reinf. (no junction box)	N/A	\$90.00
Conduit/raceway - includes wire pull (Levels 1-3)	\$190.00	N/A

LABEL PREPARATIONS		
Description	Door	Frame
Mark numbers	No charge	No charge
UL Mylar Label - Level 1 only (standard unless specified otherwise)	\$20.00	\$22.00
UL Metal Label - Level 1 only	\$48.00	\$29.00
ITS/Warnock Hersey Metal label - Level 1 only	\$48.00	\$29.00

SPECIAL FINISH PREPARATIONS		
Description	Door	Frame
Second coat of primer	N/A	N/A
Finish paint setup charge (never waived)	N/A	N/A
Finish paint <ul style="list-style-type: none"> <li>▪ Minimum quantity of 20 color</li> <li>▪ Price includes full carton wrap</li> </ul>	N/A	N/A

ANCHOR OPTIONS		
Description	Door	Frame
Welded in prepared opening anchor (per anchor)	N/A	\$16.00
Welded in anchor (per anchor)	N/A	\$7.00
Punch and dimple only (per prep)	N/A	\$5.50

Frames up to 7'0" - quantity of anchors = 6 (max 8-3/4" depth).  
 Frames over 7'0" thru 10'0" - quantity of anchors = 8 (max 8-3/4" depth).  
 Jamb depths over 8-3/4" will have (2) anchors per location.

FRAME CONSTRUCTION		
Description	Door	Frame
Unit bundle (3pc)	N/A	N/A
Standard face weld (3pc)	N/A	Included
Full profile weld (3pc)	N/A	\$208.00

FRAME PROFILE OPTIONS		
Description	Door	Frame
Single rabbet	N/A	N/A
4" Face heads (through 4'0")	N/A	\$59.00
4" Face Heads (over 4'0")	N/A	\$83.00
Non-standard face - per frame	N/A	\$65.00

Note: Non-standard face is Level 1 only.

DOUBLE SWING PREPARATION		
Description	Door	Frame
Attaching astragal (includes bullet flat bar astragal, Levels 1-3 only, required)	\$651.00	N/A
Flush bolt prep (ANSI 115.4) (Levels 1-3 only)	\$95.00	\$59.00
Surface bolt reinforce only (Levels 1-3 only)	\$36.00	\$30.00
Open back strike	N/A	N/A

GLASS KIT OPTIONS			
Up to and including Level 3 only	Vision/ Narrow Lite up to 100 inch <sup>2</sup>	Half Glass over 100 inch <sup>2</sup> up to 800 inch <sup>2</sup>	Full Glass over 800 inch <sup>2</sup>
	Anemostat BR7 Kit	\$1,682.00	\$2,754.00

Note: Anemostat BR7 Kit is kit only, approved glass by others.

See [Engineering Section](#) for further options and/or details.

### DF SERIES

#### Tornado Resistant

refer to technical data sheet on page 14

#### DOOR

- 3-Sided
  - minimum size 3'0" x 6'8"
  - maximum size 8'0" x 8'0"
- 4-Sided
  - minimum size 2'8" x 4'3"
  - maximum size 8'0" x 8'0"
- Glass light assembly only available with standard factory installed glass
- All hardware functions must be specified
- Paired opening prices shown are for applications with or without astragals
- 3/4" standard for 1/2" ADA saddle threshold. Typical undercut must provide 1/4" max between bottom of door and top of finished floor/threshold; critical distance-bottom of door to top of strike 1/8-1/4" for LM and 1/8" for WS devices.

#### FRAME

- Jamb Depths: All DF Series frames are double rabbet only with 1/2" returns. Max 10-3/4". All frames listed are available in jamb depth increments of 1/8".
- Door Opening Sizes: Standard frame sizes are listed. Any non-standard frame width and/or height is priced as the next larger size frame category. Available sizes displayed.
- Only available in 2" face with 2" or 4" face heads.
- New Masonry anchors (Masonry T) and Existing Masonry anchors (installed Tube and Strap with punch and dimple) are required and will be added to the end of your order based on opening size and wall construction.

DF SERIES					
3-Sided and Glass Door Pricing			4-Sided and Shutter Pricing <sup>1</sup>		
Door height	Door width	14 Gauge	Door height	Door width	14 Gauge
Up to 6'8"	3'0" – 4'0"	\$6,687	Up to 6'8"	2'8" – 4'0"	\$6,687
	6'0" – 8'0"	\$13,374		5'4" – 8'0"	\$13,374
Up to 7'0"	3'0" – 4'0"	\$7,164	Up to 7'0"	2'8" – 4'0"	\$7,164
	6'0" – 8'0"	\$14,328		5'4" – 8'0"	\$14,328
Up to 7'2"	3'0" – 4'0"	\$7,802	Up to 7'2"	2'8" – 4'0"	\$7,802
	6'0" – 8'0"	\$15,604		5'4" – 8'0"	\$15,604
Up to 8'0"	3'0" – 4'0"	\$8,437	Up to 8'0"	2'8" – 4'0"	\$8,437
	6'0" – 8'0"	\$16,874		5'4" – 8'0"	\$16,874

<sup>1</sup> Available as Flush doors only; no glass allowed.

DF14 COMPLETE FRAME PRICING					
Single Frame		Jamb Depth			
Width	Height	5-3/4" thru 5-7/8"	6" thru 7-7/8"	8" thru 9-7/8"	10" thru 10-3/4"
2'8" – 4'0"	6'8"	\$769	\$832	\$903	\$968
	7'0"	\$826	\$883	\$957	\$1,015
	7'2"	\$915	\$970	\$1,045	\$1,105
	8'0"	\$1,033	\$1,090	\$1,164	\$1,227
Double Frame		Jamb Depth			
Width	Height	5-3/4" thru 5-7/8"	6" thru 7-7/8"	8" thru 9-7/8"	10" thru 10-3/4"
5'4" – 8'0"	6'8"	\$1,054	\$1,134	\$1,207	\$1,274
	7'0"	\$1,102	\$1,174	\$1,249	\$1,314
	7'2"	\$1,190	\$1,256	\$1,339	\$1,404
	8'0"	\$1,322	\$1,396	\$1,477	\$1,542

	SINGLE		PAIR	
	Min.	Max.	Min.	Max.
3-sided	3'0" x 6'8"	4'0" x 8'0"	6'0" x 6'8"	8'0" x 8'0"
4-sided	2'8" x 4'3"	4'0" x 8'0"	5'4" x 4'3"	8'0" x 8'0"

STANDARD CONSTRUCTION FRAMES	
A60 Galvanized steel	No charge
4" Face head (through 4'0")	\$59.00
4" Face heads (over 4'0")	\$83.00
Mark numbers	No charge
APPROVED ANCHORAGE (required in jambs, heads and sills)	
New Masonry (CMU block walls)	
Jambs: Masonry-T jambs	No charge
Head (choose 1 type):	
EMA head T&S anchor, P&D, factory install order bolts as listed under "Existing Masonry > T&S"	\$24.25
Lintel 2" wedge anchor assembly	\$19.50
Lintel 4" wedge anchor assembly	\$24.50
Weld-in base anchor	No charge
New Concrete (poured in place or tilt-up)	
Steel embed plates (plates by others): T&S, no P&D	\$18.75
Z anchor (full length per jamb, head, or sill) <sup>1</sup>	\$85.00
Existing Masonry (must specify concrete or CMU block walls)	
T&S anchor, P&D, factory installation	\$24.25
5" Bolts for 2" face jambs and heads (Q326)	\$20.00
7-1/4" Bolts for 4" face heads (Q327 + Q325)	\$23.50
Steel plates (manuf by others) bolted to wall: T&S, no P&D <ul style="list-style-type: none"> <li>▪ Bolts: See above. If shorter needed, call for specs.</li> <li>▪ Frame welded to steel plates on site</li> <li>▪ Lowest EMA serves as base anchor for Paladin</li> </ul>	\$18.75
Anchoring to Structural Steel	
Welded - T&S anchor (no P&D), factory install	\$18.75
Bolted - T&S anchor, P&D, factory install	\$24.25
4" zinc-plated bolt assy for 2" face	\$17.00
6" zinc-plated bolt assy for 4" face heads <ul style="list-style-type: none"> <li>▪ See McMaster-Carr for optional 5" zinc and 7" black-oxide bolts</li> </ul>	\$27.00
4-Sided frame, add for sill section	\$112.00
12 Gauge head reinforcing channel	Included

1. Anchorage choice with an engineering request; extended lead time.
2. Jamb Depths
  - All FP frames are double rabbet only.
  - Max JD 10-3/4". All frames listed are available in jamb depth increments of 1/8".
3. Door Opening Sizes
  - Standard frame sizes are listed.
  - Any non-standard frame width and/or height is priced as the next larger size frame category.
  - Available sizes displayed above.
4. Only available in 2" face with 2" or 4" face heads.
5. Case Open Frames are not available.
6. New Masonry anchors (Masonry T) and Existing Masonry anchors (installed Tube and Strap with punch and dimple) are required and will be added to the end of your order based on opening size and wall construction. See Steelcraft tech data for correct usage.
7. FBC EHPA Hurricane/Tornado door and frame labels can be added to ICC500 labels for flush door assemblies only per FL41734.1. Not available with shutters, glass lights, or Securitech hardware.

LABELED DOOR		
Description	Single	Pair
UL:	N/A	N/A
ITS/WHI: Metal label <sup>1</sup> - .75, 1, 1.5, 3 hour	\$48.00	\$94.00
20 minute or smoke and draft	\$20.00	\$40.00
FM:	N/A	N/A
ICC500-2014/FEMA 361/320 label	No charge	No charge
FBC EHPA Hurricane/Tornado label	\$20.00	\$40.00

1. Glass lights rated up to 1.5 hours max.

LABELED FRAME		
Description	Single	Pair
UL:	N/A	N/A
ITS/WHI: Metal label <sup>2</sup> - .75, 1, 1.5, 3 hour	\$29.00	\$58.00
20 minute or smoke and draft	\$22.00	\$44.00
FM:	N/A	N/A
ICC500-2014/FEMA 361/320 label	No charge	No charge
FBC EHPA Hurricane/Tornado label	\$22.00	\$44.00

2. Glass lights rated up to 1.5 hours max.

STANDARD CONSTRUCTION DOORS	
A60 Galvanized steel	Included
G90 Galvanized steel	N/A
Edge seam construction (welded and seam filled)	Included
12 Ga top channel as top cap	Included
Mark numbers	No charge
Dutch door	N/A
Lock/latch with astragal per/pair <sup>3</sup>	\$95.00
Lock/latch without astragal per/pair	\$95.00
Push pull without astragal	N/A
Glass light assy: Vision (V) non-label (9-1/2" x 9-1/2") <sup>4</sup>	\$5,361.00
Glass light assy: Vision (VF) label (9-1/2" x 9-1/2") <sup>4</sup>	\$10,571.00
Glass light assy: Narrow (N) non-label (4-1/8" x 26-11/16") <sup>4</sup>	\$5,808.00
Glass light assy: Narrow (NF) label (4-1/8" x 26-11/16") <sup>4</sup>	\$11,016.00

3. Not recommended with panic exit hardware.
4. Factory installed and approved Glass and Trim, 3-Sided Only (no shutters).

LEADLINED

BULLET RESISTANT

DF SERIES

HURRICANE/WIND RESISTANT

SOUND TRANSMISSION CONTROL

HINGE PREPARATIONS	DOOR
5" Universal in lieu of 4-1/2" Universal <ul style="list-style-type: none"> <li>Approved models: IVES 3CB1, 3CBJHW, 3CBINRO, 3CB1HWNRP, 3CB1SH, 3CB1HWSH, 5BB1, 5BB1HW, 5BB1NRP, 5BB1HWNRP, 5BB1SH, 5BB1HWSH, 5BB1WT, 5BB1HW WT</li> </ul>	No charge
Additional hinge prep	\$25.00
High frequency prep	\$54.00
Continuous hinge (full mortise, full length reinf.) <ul style="list-style-type: none"> <li>Approved models:                             <ul style="list-style-type: none"> <li>IVES Alum Geared: 112HD, 112XY, 224HD, 224XY</li> <li>IVES Steel Pin and Barrel: 600, 700, 700CS, 705</li> <li>IVES Electric: TW8, TWP</li> </ul> </li> </ul>	\$88.00

CLOSERS/HOLDERS/STOPS	DOOR
20" reinforced	Included
Holder/Stop - full door width reinforced <ul style="list-style-type: none"> <li>Approved models: LCN 4000T, 4010, 4010T, 4020, 4020T, 4030, 4030T, 4040XP, 4040XPT, 4050, 4110, 4110T, FALCON SC70 (heavy duty), SC80A, SC60A</li> </ul>	\$74.00
Concealed or semi-concealed (per template)	N/A
Allegion Concealed or semi-concealed (per template)	N/A
Surface Overhead Holder/Stop <ul style="list-style-type: none"> <li>Approved models: GJ 79S (extra heavy duty), 70S, 90S, 81S</li> <li>Confirm that your choice opens 180° if needed and as configured</li> </ul>	Specify
Surface Floor and Wall Stops/Holders (thru bolted) <ul style="list-style-type: none"> <li>Approved models: IVES (attached to exterior with steel screws per manufacturers instructions. Interior application must use IVES FS495 thru bolted to the door, at the bottom only) only, min 6" from lock or strike side of door.</li> </ul>	No prep

LOCKS/LATCHES	DOOR
<b>Schlage MultiPoint, lever with CVR (concealed vertical rods)</b>	
3-point: LM/LMV9300 (rose or escutcheon trim)	\$3,088.00
IVES SB360 Top and bottom surface bolts for inactive leaf	No charge
<b>Securitech concealed rods (field drilled)</b>	
2-point: 52xx-V (vert deadbolt top and bottom)	\$757.00
3 point: 53xx (primary and vert deadbolts)	\$757.00
3-point: 8L (primary and vert deadbolts)	\$757.00
Optional HVL HOVE bottom jamb (with 53xx)	\$113.00
7L Series with IHD concealed rods and HOVE bottom jamb bolt	\$1,020.00
<b>FEMA 320-only solutions (for less than 16 occupancy only)</b>	
Medeco 3-deadbolt FEMA 320 solution with Schlage ND lockset or Falcon T Series	\$188.00
Special Vertical: hinge and lock locations	No charge

EXIT DEVICES	DOOR
<b>Von Duprin, panic bar exit with SVR (surface rods, reinf only)</b>	
2-point: WS98/9927 (Fire rated only with pair)	No charge
3-point: WS98/9957 (Fire rated only with single)	No charge
<b>Securitech 3-point surface rods (field drilled)</b>	
Securitech 8T Series	\$877.00
Optional HVL HOVE bottom jamb bolt	\$113.00
<b>Securitech 3-point IHD concealed rods (field drilled)</b>	
Securitech 7T Series with IHD concealed rods and HOVE bottom jamb bolt (HVL)	\$998.00

ELECTRICAL PREPS	DOOR
Power transfer units (i.e. EPT2, EPT10, etc.) <ul style="list-style-type: none"> <li>Approved models: Von Duprin EPT2, EPT10</li> </ul>	\$137.00
Electric hinge prep	\$25.00
Auto operators <ul style="list-style-type: none"> <li>Approved models: LCN 9952 for pairs, 9542 for singles</li> <li>Must be mounted to exterior/storm side of storm shelter or safe room</li> <li>MUST order 5" heavy weight hinges and high frequency hinge reinforcements.</li> </ul>	No charge
Electric door closer <ul style="list-style-type: none"> <li>Approved models: LCN Sentronic 4040SE, 4310ME</li> <li>Must be mounted to exterior/storm side of storm shelter or safe room</li> </ul>	No charge
Magnetic Hold open <ul style="list-style-type: none"> <li>Approved models: LCN SEM 7800</li> <li>Extenders not permitted on inswing applications. Locate away from hardware/rod locations to avoid interference.</li> </ul>	Specify
Door position switch (round 1/2" to 1" dia.) <ul style="list-style-type: none"> <li>Approved models: Schlage 679-05, Sentrol 1078/1076</li> <li>Must be mortised into the edge or top of the door and into the door rabbet of the jamb or head of the frame</li> </ul>	\$23.00
Magnetic switch (rectangular and mortised) <ul style="list-style-type: none"> <li>Approved models: Schlage 7764, Sentrol 2757, Securitron MSS-1 high security</li> <li>Must be mortised into the edge or top of the door and into the door rabbet of the hinge jamb or head of the frame</li> </ul>	N/A
Wiring raceway (with conduit)	\$190.00

KICK PLATES	DOOR
Approved models: IVES 8400 (metal or plastic), 8402 (metal) (must be secured with steel screws, 48" max height bottom of door only).	

THRESHOLDS AND GASKETING	DOOR
Approved models: ZERO (must not impede or affect the function of the opening or latching hardware)	

<p><b>Door Notes:</b></p> <ol style="list-style-type: none"> <li>Only approved models are allowed. See website for links to approvals.</li> <li>WS available as EO (exit only); NL (night latch) not available.</li> <li>Electronic options available with Allegion WS device and Securitech 7L, 7T, and 8T series.</li> </ol>
--



HINGE PREPARATIONS	FRAME
5" Universal in lieu of 4-1/2" Universal <ul style="list-style-type: none"> <li>Approved models: IVES 3CB1, 3CBJHW, 3CBINRO, 3CB1HWNRP, 3CB1SH, 3CB1HWSH, 5BB1, 5BB1HW, 5BB1NRP, 5BB1HWNRP, 5BB1SH, 5BB1HWSH, 5BB1WT, 5BB1HW WT</li> </ul>	No charge
Additional hinge prep	\$23.00
High frequency prep	\$26.00
Continuous hinge (full mortise, full length reinf.) <ul style="list-style-type: none"> <li>Approved models:                             <ul style="list-style-type: none"> <li>IVES Alum Geared: 112HD, 112XY, 224HD, 224XY</li> <li>IVES Steel Pin and Barrel: 600, 700, 700CS, 705</li> <li>IVES Electric: TW8, TWP</li> </ul> </li> </ul>	\$83.00

CLOSERS/HOLDERS/STOPS	FRAME
Surface Mounted Closers: 14" strap installed <ul style="list-style-type: none"> <li>Approved models: LCN 4000T, 4010, 4010T, 4020, 4020T, 4030, 4030T, 4040XP, 4040XPT, 4050, 4110, 4110T, FALCON SC70 (heavy duty), SC80A, SC60A</li> </ul>	No charge
Concealed or semi-concealed (per template)	N/A
ALLE Concealed or semi-concealed (per template)	N/A
Surface Overhead Holder/Stop <ul style="list-style-type: none"> <li>Approved models: GJ 79S (extra heavy duty), 70S, 90S, 81S</li> <li>79 series does not open 180° so application should be confirmed</li> </ul>	Specify

ELECTRICAL PREPS	FRAME
Power transfer units (i.e. EPT2, EPT10, etc.) <ul style="list-style-type: none"> <li>Approved models: Von Duprin EPT2, EPT10</li> </ul>	\$104.00
Electric hinge prep	\$55.00
Auto operators <ul style="list-style-type: none"> <li>Approved models: LCN 9953 for pairs, 9542 for singles</li> <li>Must be mounted to exterior/storm side of storm shelter or safe room</li> <li>MUST order 5" heavy weight hinges and high frequency hinge reinforcements</li> </ul>	No charge
Electric door closer <ul style="list-style-type: none"> <li>Approved models: LCN Sentronic 4040SE, 4310ME</li> <li>Must be mounted to exterior/storm side of storm shelter or safe room</li> </ul>	No charge
Door position switch (round 1/2" to 1" dia.) <ul style="list-style-type: none"> <li>Approved models: Schlage 679-05, Sentrol 1078/1076</li> <li>Must be mortised into the edge or top of the door and into the door rabbet of the jamb or head of the frame</li> </ul>	\$22.00
Magnetic switch (rectangular and mortised) <ul style="list-style-type: none"> <li>Approved models: Schlage 7764, Sentrol 2757, Securitron MSS-1 high security</li> <li>Must be mortised into the edge or top of the door and into the door rabbet of the jamb or head of the frame</li> </ul>	N/A

STRIKES	FRAME
<b>Von Duprin</b>	
Vertical Rod reinf for 2-point: WS98/9927(F)	No charge
Rim and Vertical Rod reinf for 3-point: WS98/9957(F)	No charge
<b>Schlage</b>	
Vertical Rod reinf for 3-point: LM/LMV9300	No charge
<b>Securitech</b>	
Vertical Rod reinf for 53xx, 7L, 7T, 8L, or 8T Series (field drilled)	No charge
HVL HOVE bolt option jamb prep for 53xx, 8L, or 8T Series; HVL required for 7L, and 7T (holes field drilled)	No charge
Medeco 3 dead locks	\$188.00
<b>IVES</b>	
SB360 Top and bottom surface bolts for inactive leaf	No charge

THRESHOLDS AND GASKETING	FRAME
Approved models: ZERO (must not impede or affect the function of the opening or latching hardware)	

FRAME CONSTRUCTION	FRAME
Standard face weld (3pc)	\$116.00
Full profile weld (3pc)	\$208.00
Standard face weld (4pc)	\$232.00
Full profile weld (4pc)	\$416.00

<p><b>Frame Notes:</b></p> <ol style="list-style-type: none"> <li>Only approved models are allowed. See website for links to approvals.</li> <li>Junction boxes provided with most electrical preps. Knockouts are designed to support 1/2' or 3/4' conduit.</li> <li>Electrical preps will be reviewed by engineering.</li> </ol>
--

## HUR(I) DL/DE SERIES IMPACT DP/DL/DE SERIES NON-IMPACT

### Hurricane and wind resistance

**Hurricane Impact** assemblies require specially constructed DL/DE doors identified as HUR(I) prefix.

**Non-Impact/E330** labeled openings may also use standard DP/DL/DE doors.

See DP/DL/DE pages for pricing and options.

- Door Thickness – 1-3/4" (14 gauge = 1-13/16")
- Actual Door Size – Door undersized from nominal by 1/4" in width and 1/2" in height. Std undercut 3/8" or per listing threshold requirements.
- Core – Honeycomb Core. Optional Polystyrene, Stiffened, Polyurethane (non-fire label), Temp Rise
- Hinge Rail and Reinforcement – 10 gauge hinge reinforcements. Hinge edge is non-beveled and reinforced with a continuous 16 gauge steel channel projection welded at a maximum of 5" OC (optional 10 ga - DE Series).
- Lock Rail – Lock edge is non-beveled (bevel 1/8" in 2" option) and reinforced with hurricane channel and a continuous 16 gauge steel channel projection welded at a maximum of 5" OC (optional 14 gauge - DE Series).
- Top Channel – Top channel is a flush 16 gauge steel channel, projection welded at a max 2-1/2" OC
- Bottom Channel – Bottom channel is an inverted 16 gauge steel channel, projection welded max 2-1/2" OC
- Face Skins – HUR(I) 16 gauge or 14 gauge A60 galvanized steel (G90 Galv option by special request)
- See FBC and TDI Third Party (FBC) listings, [RepublicDoor.com](http://RepublicDoor.com), hurricane section ordering tools for more information on approved offerings and ordering
- Closer reinforcement – 14 Gauge 18" x 6" (Optional 12 Gauge)
- Size Availability
  - Max. 4'0" x 8'0" (Singles)
  - Max. 8'0" x 8'0" (Pairs)
- SDI 100 - Grade/Model for HUR(I) Impact – Levels 3-4 and Models 1 and 2 (Extra Heavy Duty and Maximum Duty Commercial and Institutional)
- Fire Label Range – 20 minute through 3 hour/ Underwriters Laboratory or Warnock Hersey
- Windstorm labels – FBC labels supporting FBC and TDI
  - FBC Impact
  - FBC E330 Non-Impact (see standard DP/DL/DE product pricing)
- Edge Seam Construction – Visible seam is standard. Continuously welded seamless or intermittently welded seamless available. (Options)
- Universal Standard/Heavy Weight Hinge – Hinge fillers are used allowing for easy modification from heavy to standard weight hinge prep
- Handing Design – Non-handed standard (Optional handed)



LEAD LINED

BULLET RESISTANT

DF SERIES

HURRICANE/WIND RESISTANT

SOUND TRANSMISSION CONTROL

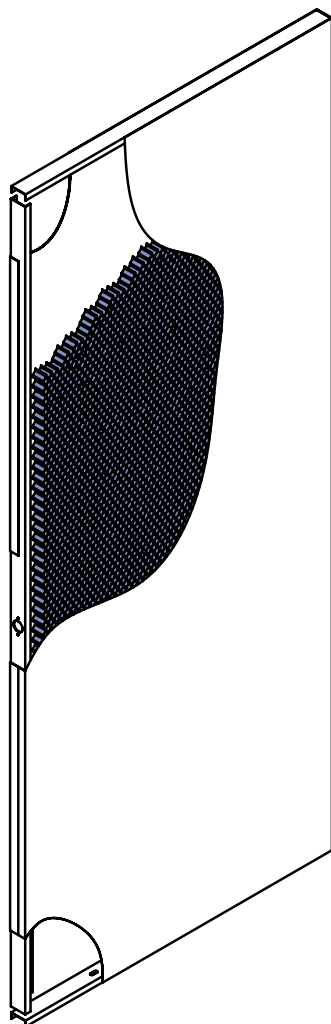

**Hurricane impact assemblies** include extra heavy duty windstorm resistant door construction per listing approvals.

**Standard frames** are used with anchors/locations and details as specified in listing approvals.

Assembly with standard Honeycomb (optional cores available).

Refer to Listings and COACH validations for all available door, frame and hardware options.

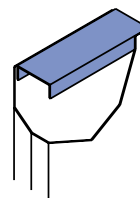

Flush Top

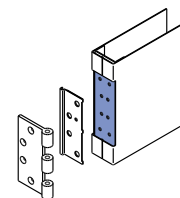

Door Hinge Prep

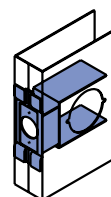

Cyl Prep (E330 shown)

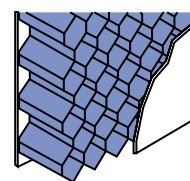

Honeycomb Core

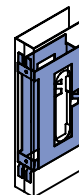

Mortise Prep (E330 shown)

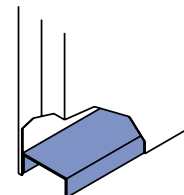

Inverted Bottom Channel

ORDERING FBC AND TDI APPROVED REPUBLIC HURRICANE PRODUCTS

Approved Products and Labels

- FBC Approved assemblies with Allegion Hardware (iink below)
  - Impact Labeled Hurricane Doors: HUR(I) - DL16/DE14
  - Non-Impact E330 Labeled Doors: DP/DL/DE standard series
  - Impact or Non-Impact Frames and Elevations: ME/SE standard series with approved anchors
  - See next pages for FBC approved product pricing and offering ranges
- TDI Approved assemblies with Allegion hardware
  - Order as FBC labeled products supported by TDI's Third-Party Evaluation Reports
- UL and WHI fire labels available up to 3 hours

Go to [RepublicDoor.com](http://RepublicDoor.com), hurricane section, for downloadable tools and helpful links, including:

- COACH: FBC Order Assistant and Order Form Generation tool (order wizard)
- Approval LOOKUPS: Filterable summary of FBC
- Anchor LOOKUP: Anchor types and quantities for FBC
- Public Listing Links to [FBC](#) and [TDI Door Assemblies](#), and [TDI Store Front Systems](#)
- Code Requirements and additional information

Note: Please verify that you have the latest versions of the Hurricane Order Form (COACH), Lookup Tool, Approvals/install instructions, and Price Book before ordering and installing. The Authority Having Jurisdiction is the final authority in issues related to the installation and use of any building products. While we have tried to maintain accuracy in product literature and tools, Allegion is not responsible for errors and omissions, and is not responsible for verifying that the correct products for your opening are ordered or installed correctly in the field. This is the responsibility of the contractor and their architects and engineers.

SDI CLASSIFICATIONS				
Grade		Model	Construction	Republic Series
II	Physical Performance Level A 1-3/4" (44) Only Heavy Duty Minimum Gauge = 18	1	Full Flush-Non-Impact	DP 418, DL 418, DE 418
		2	Seamless-Non-Impact	DL 418, DE 418
III	Physical Performance Level A 1-3/4" (44) Only Extra-Heavy Duty Minimum Gauge = 16	1	Full Flush-Non-Impact	DL 416, DE 416
		2	Seamless-Non-Impact	DL 416, DE 416
		1	Flush-Impact	HUR(I) DL 416
		2	Seamless-Impact	HUR(I) DL 416
IV	Physical Performance Level A 1-3/4" (44) Only Extra-Heavy Duty Minimum Gauge = 14	1	Full Flush-Non-Impact	DE 414
		2	Seamless-Non-Impact	DE 414
		1	Flush-Impact	HUR(I) DE 414
		2	Seamless-Impact	HUR(I) DE 414

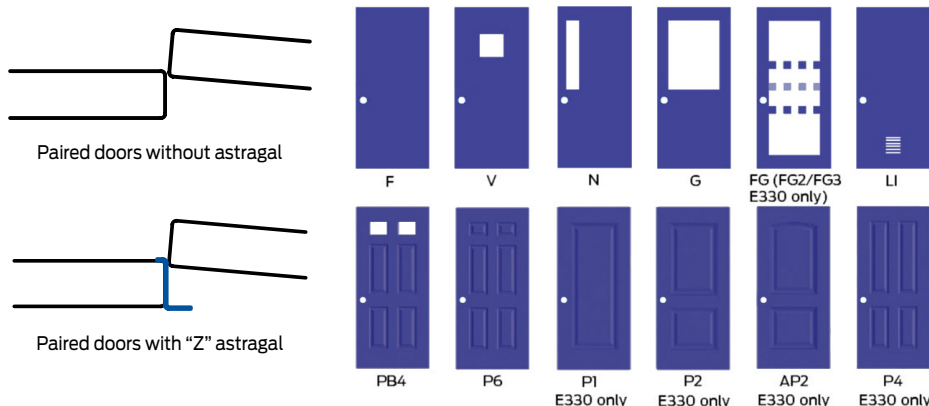

**NOTE** – See standard embossed doors for “E330 only” door pricing. Other emboss patterns available for impact with 50-door MOQ. Call for availability and pricing.

### HUR(I) Impact Door options and pricing:

See standard door pages for Non-Impact/E330

HONEYCOMB HUR(I) - DL/DE IMPACT DOORS <sup>1</sup>				
Door Height	Door Width	DL16	DE14	DL16-Emb <sup>2</sup>
Up to 6'8"	1'6" – 2'8"	\$1,367	\$1,650	N/A
	Over 2'8" – 3'0"	\$1,440	\$1,754	\$1,748
	Over 3'0" – 3'6"	\$1,580	\$1,921	N/A
	Over 3'6" – 4'0"	\$1,680	\$1,990	N/A
Up to 7'0"	1'6" thru 2'8"	\$1,409	\$1,740	N/A
	Over 2'8" – 3'0"	\$1,466	\$1,829	\$1,782
	Over 3'0" – 3'6"	\$1,637	\$1,990	N/A
	Over 3'6" – 4'0"	\$1,722	\$2,067	N/A
Up to 7'2"	1'6" – 2'8"	\$1,440	\$1,771	N/A
	Over 2'8" – 3'0"	\$1,496	\$1,860	N/A
	Over 3'0" – 3'6"	\$1,653	\$2,035	N/A
	Over 3'6" – 4'0"	\$1,738	\$2,125	N/A
Up to 8'0"	2'8" – 3'0"	\$1,834	\$2,319	\$2,311
	Over 3'0" – 3'6"	\$1,976	\$2,424	N/A
	Over 3'6" – 4'0"	\$2,047	\$2,492	N/A

- Price includes FBC Impact label, Fasseal Door Sweep, A60 Steel, CH/MOL, 4-1/2" Hinges.
- Other emboss patterns available with 50 door MOQ and longer lead times. Call for availability and pricing.

#### HUR(I) - DL/DE IMPACT LABELED HURRICANE DOORS

- Option Ranges based on specific configurations in Approvals
- Inward and Outward Design Pressures available up to 50-170 PSF
- Max opening 4'0" x 8'0" single and 8'0" x 8'0" pair
- Max exposed glass based on hardware 34.25" w x 74.5" h or 24" w x 64" h or 100" sq limit using standard 3" w x 33" h, 4" w x 20" h, or 5" w x 20" h (70 max pressure per glass trim)
- Max louver: Impact openings 35.78" w x 76.03" h (cylinder and mortise locks only)

#### DP/DL/DE NON-IMPACT/E330 LABELED DOORS

- See [Engineering Section](#) for pricing. E330 label to standard DP18, DL 16/18, DE 14/16/18
- Inward and outward design pressures available up to 40-60 PSF
- Max opening 4'0" x 8'0" single and 8'0" x 8'0" pair
- Max exposed glass 34.25" w x 74.5" h (70 max pressure per trim)
- See DP/DL/DE standard series pages for pricing and options with E330 labels

#### HURRICANE FRAMES FOR IMPACT OR NON-IMPACT E330 OPENINGS

- See standard ME14/16 and SE12/14/16 product/pricing with options as defined in FBC/TDI approvals
  - Typ exterior 14 gauge ME used with 16 gauge doors
  - Typ interior 16 gauge ME used with 18 gauge doors
- Max door opening 8'0" x 8'0"
- KD or Welded
- Jamb depths 5-3/4" thru 14-3/4"
- 2" face jambs, 4" face head option
- Elevation borrowed lite/storefronts calculated (see listing). Max exposed glass 54.75" w x 80.75" h or 34.75" w x 116.75" h
- Anchor quantity, type, and locations vary per approval

See ME and SE pages for pricing and options for both Impact and Non-impact E330 labels.

INSULATED CORES	DOOR
Honeycomb	Included
Polystyrene	\$39.00
Polystyrene embossed	See chart
Polyurethane	\$194.00
Steel stiffened (20 gauge stiffeners with fiberglass insulation, standard)	\$301.00
Steel stiffened (20 gauge stiffeners with polystyrene insulation)	\$352.00
Temperature rise (250° mineral fiberboard)	\$1,005.00

STEEL TYPES	DOOR
A60 Galvanized steel	Included
G90 Galvanized steel (14 and 16 gauge only) upon request	\$419.00

HINGE PREPARATIONS	DOOR
Special hinge locations	No charge
4-1/2" Universal hinge prep (1) prep for every 30" in height	No charge
Additional hinge prep (per hinge)	\$25.00
5" Universal hinge prep (per hinge)	No charge
Electric hinge <ul style="list-style-type: none"> <li>No conduit, no wiring included</li> <li>One 1/2" dia. hole in one hinge reinf.</li> </ul>	\$25.00
Surface mounted hinges (reinforced only)	N/A
Continuous hinge reinforcement	\$88.00
Special backset (per hinge)	N/A
Power transfer <ul style="list-style-type: none"> <li>No junction box or conduit, no wiring</li> <li>Cutout with reinforcement/tap plate(s)</li> </ul>	\$131.00

LOCK PREPARATIONS	DOOR
Special lock location	No charge
Special lock backset up to 5"	No charge
Sectional trim prep (mortise lock with function holes)	\$56.00
Cylindrical dead lock - Gov't 160 or 161 prep	\$61.00
Mortise dead lock - Gov't 86 mortise lock prep	\$61.00
Rim reinforcement only	\$50.00
Rim reinforcement with function prep	\$56.00
Mortise exit device reinforcement only	\$37.00
Mortise exit device reinforcement with function prep	\$89.00
Surface vertical rod reinforcement only	\$82.00
Surface vertical rod reinforcement with function prep	\$99.00
Concealed vertical rod	\$611.00
Exit alarm reinforcement only	\$62.00
Inset exit device (14 and 16 gauge doors only)	N/A
Push pull reinforcement	N/A

#### Notes:

Refer to Republic FBC/TDI Hurricane Listings to verify approved options prior to ordering.  
(Reference COACH and LOOKUP tools for assistance)

CLOSER PREPARATIONS	DOOR
Closer reinforcement	\$37.00
Concealed overhead door closer, holder or stop	N/A

SPECIAL CONSTRUCTIONS	DOOR
UC - less than 3/8", price as next larger size	No charge
Inverted top channel	No charge
Flush bottom channel	No charge
Dutch door (4) 4.5" hinge preps x (1) 161 lock prep	N/A
Unifit hinge channel	N/A
Seal top or bottom channel and finish smooth each	\$142.00
Mag switch/DPS - Hole only	\$23.00
Mag switch/DPS - Prep and reinf.	\$123.00
Continuous welded edge (N/A in 20 gauge)	\$169.00
Bondo filled edge	\$115.00
Beveled lock edge (1/8" in 2") N/A in 14 gauge and Inactive leafs with strike(s)	\$23.00
10 Gauge hinge/14 gauge lock channels DE Series (standard on 14 gauge door)	\$156.00
Door viewer	\$30.00
Mail slot	N/A
Automatic door bottom (mortise type)	N/A
Conduit/raceway - includes wire pull (available with electric hinge or power transfer options)	\$190.00

SPECIAL FINISH PREPARATIONS	DOOR
Second coat of primer	\$124.00
Finish paint setup charge (never waived)	\$1,350.00
Finish paint <ul style="list-style-type: none"> <li>▪ Minimum quantity of 20 per color</li> <li>▪ Price includes full carton wrap</li> </ul>	\$274.00

LABEL PREPARATIONS	DOOR
Mark numbers	No charge
U.L. Mylar fire label (standard unless specified otherwise)	\$20.00
U.L. Metal fire label	\$48.00
Warnock Hersey Metal fire label	\$48.00
Hurricane FBC Label on HUR(I) - DL/DE	No charge
Hurricane E330/Non-Impact label on standard DP/DL/DE	\$48.00
Hurricane TDI: Use FBC label on HUR(I) - DL/DE	No charge
Hurricane/Tornado FBC EHPA label	Use DF Series

INACTIVE LEAF PREPARATIONS	DOOR
Flush bolt embossed top/bottom channel (E330 only)	No charge
Cylindrical (2-3/4") dead lock strike	\$61.00
Electric strike (no conduit)	N/A
ASA Strike only	\$59.00
Attaching astragal (includes astragal)	\$110.00
Flush bolt prep (ANSI 115.4) - E330 only	\$95.00
Surface bolt reinforce only	\$36.00
Open back strike	N/A

GLASS/LOUVER INSERT OPTIONS			
	Vision/ Narrow Lite up to 100 inch	Half Glass over 100 inch up to 800 inch	Full Glass over 800 inch
Cutout with reinforcement	\$299	\$395	\$471
Glass pocket add (other than 1/4")	\$209	\$209	\$209
Hurricane approved light kits - Air louvers VLFIGHRC or VLFEZHRC (add to Cutout price above)	\$1,644	\$2,979	\$2,979
Hurricane approved louver insert - Air louvers 1500 (add to Cutout price above) (Call for other sizes)	\$751 (10x10)	\$1,478 (up to 24x24)	\$3,466 (up to 24x60)

**Note: Refer to listings for availability**

Bullet Resistant Options  
(see [Specialty Section](#))

Refer to Republic FBC/TDI Hurricane Listings to verify approved options prior to ordering  
(Reference COACH and LOOKUP tools for assistance)

### SOUND TRANSMISSION CONTROL (STC) ECO

#### Specialty

refer to technical data sheet on page 14

#### SOUND TRANSMISSION CONTROL (STC) 40, 42, 43 and 47 DOORS

- Thickness – 1-3/4" (+/- 1/16")
- Actual Door Size – Door undersized from nominal by 1/4" in width and 1/2" in height. Standard undercut is 3/8". Undercut contingent on threshold.
- Hinge Rail and Reinforcement – Hinge edge is non-beveled and reinforced with a continuous 16 gauge steel channel projection welded to each skin at a maximum of 5" on center. Hinge channels have an additional 9 gauge reinforcement at each hinge location, providing over 3/16" reinforcement (Backset 1/4")
- Lock Rail – Lock edge is non-beveled and reinforced with a continuous 16 gauge steel channel. 16 gauge reinforcements for mortised or cylindrical locks are of an integral type in accordance with ANSI A115 standards.
- Top Channel – Top channel is flush 16 gauge channel, projection welded at a maximum of 2-1/2" on center
- Bottom Channel – Bottom channel is 16 gauge flush, projection welded at a maximum of 2-1/2" on center
- Core – Proprietary Sound Core
- Face skin – 16 gauge – Cold Roll Steel, A60 Galvannealed or G90 Galvanized
- Closer Reinforcement (Required) – 14 gauge standard
- Size Availability – Maximum 4'0" x 8'0"
- SDI 100 Grade/Model – Grade 3/Model 1 – 2 (Physical Performance Level A)
- Edge Seam Construction – Visible edge seam standard. Optional - Intermittently welded or Continuously welded edge seam.
- Universal Standard/Heavy Weight Hinge – Hinge fillers are used allowing for an easy modification from standard to heavy weight hinge prep – 4-1/2" hinges standard.
- Handing Design – Non-Handed standard/ Optional Handed design

#### STC 40 – 6 PANEL EMBOSSED SOUND TRANSMISSION CONTROL (STC) 40 DOORS

- Thickness – 1-3/4" (+/- 1/16")
- Hinge Rail and Reinforcement – Hinge edge is non-beveled and reinforced with a continuous 16 gauge steel channel projection welded to each skin at a maximum of 5" on center. Hinge channels have an additional 9 gauge reinforcement at each hinge location, providing over 3/16" reinforcement (Backset 1/4")
- Lock Rail – Lock edge is non-beveled and reinforced with a continuous 16 gauge steel channel. 16 gauge reinforcements for mortised or cylindrical locks are of an integral type in accordance with ANSI A115 standards.
- Top Channel – Top channel is flush 16 gauge channel, projection welded at a maximum of 2-1/2" on center
- Bottom Channel – Bottom channel is 16 gauge flush, projection welded at a maximum of 2-1/2" on center
- Core – 250° Temperature Rise core
- Face skin – 16 gauge x A40 Galvannealed
- Closer Reinforcement (Optional) – 14 gauge standard
- Size Availability – Maximum 3'6" x 8'0"
- SDI 100 Grade/Model – Grade 3/Model 1 – 2 (Physical Performance Level A)
- Edge Seam Construction – Visible edge seam, standard. Optional Intermittently or Continuous welded edge seam
- Universal Standard/Heavy Weight Hinge – Hinge fillers are used allowing for an easy modification from standard to heavy weight hinge prep – 4-1/2" hinges standard
- Handing Design – Non-Handed standard/ Optional Handed design

#### SECTION 08348 ACOUSTIC STEEL DOOR AND FRAME ASSEMBLY

PART 1 - GENERAL	PART 2 - PRODUCTS
<b>Quality Assurance</b>	<b>Materials</b>
Sound Rating: Certify that the construction is identical to the Sound Transmission Classification (STC) assembly tested at an independent acoustical laboratory qualified under NVLAP by the National Institute for Science and Technology (NIST) according to ASTM E90 and that the STC rating according to ASTM E413 is not less than that specified or scheduled. Minimum STC rating shall be one of the following: 40, 42, 43, 47.	<ul style="list-style-type: none"> <li>▪ All steels used to manufacture doors, frames, anchors and accessories shall be in accordance with SDI-100/ANSI A250.8.</li> <li>▪ Door Core - shall be manufacturer's proprietary standard core to achieve specified ratings.</li> <li>▪ Shop primer shall be manufacturer's standard rust inhibitive baked on or air dried shop primer.</li> <li>▪ Door seals shall be manufacturer's standard sound seals.</li> <li>▪ Hardware shall be manufacturer's standard seals, gasketing and threshold (when required).</li> </ul>
<b>Warranty</b>	<b>Fabrication</b>
Material and workmanship shall be warranted by manufacturer for a period of one (1) year from the date of shipment. Warranty shall apply to replacement or retrofit of product only.	<ul style="list-style-type: none"> <li>▪ Doors shall be minimum 16 gauge (STC 40, 42, 43 and 47), 1-3/4" thick, without visible joints on exposed faces. Reinforce top and bottom with "flush" steel channels of not less than 16 gauge.</li> <li>▪ Door core shall be proprietary acoustic composite core as tested by manufacturer to meet specified STC rating.</li> <li>▪ Frames shall be minimum 16 gauge, face welded and ground smooth construction or KD frames on STC 40 or 42 only. Provide frames with minimum of three anchors per jamb suitable for adjoining wall construction. Provide anchors of not less than 0.042" in thickness or 0.167" diameter wire.</li> <li>▪ All frames shall be fully prepared for mortised hardware and reinforced only for surface mounted hardware. Drilling and/or tapping shall be completed by others.</li> <li>▪ Acoustical Seals shall be manufactured by ZERO International or Pemko.</li> </ul>
<b>Approved Manufacturers</b>	
Republic Doors and Frames 155 Republic Drive McKenzie TN 38201 Phone: 800-733-3667 Fax: 800-723-6677	

INSTALLATION INSTRUCTIONS FOR ACOUSTIC GASKETS

Republic's tested STC system included: R-564 threshold, R-485 head and jamb seals, R-119 spring bronze head and jamb seals.

1. The R-119 spring bronze should be installed on the bottom of the door before hanging.
2. Install the R-564 threshold to suit floor condition. Caulk round the bottom of threshold along with the entire perimeter of frame and at meeting edges of threshold and frame.
3. Close the door and measure the frame opening width and height. Install the R-485 head piece first (trim as necessary). Place the piece against the face of the door, making gentle contact between the "rubber extrusion" seal and the door, then fasten in place. Place the hinge side seal against the face of the door, making gentle contact between the "rubber extrusion" seal and the door, then fasten in place. Place the strike side seal against the face of the door, making gentle contact between the rubber extrusion seal and the door, then fasten in place.
4. Install the R-119, head piece first, then the hinge side and finally the lock side using the pressure sensitive tape to fasten the spring bronze to the frame.
5. Check operation of the door after each piece of material is installed to make sure that no binding is taking place.

SOUND TRANSMISSION CONTROL (STC) 40, 42, 43 and 47 DOORS DL Series Sound Transmission Control (STC) Doors shall be as manufactured or furnished by Republic Doors and Frames, McKenzie, Tennessee 38201.

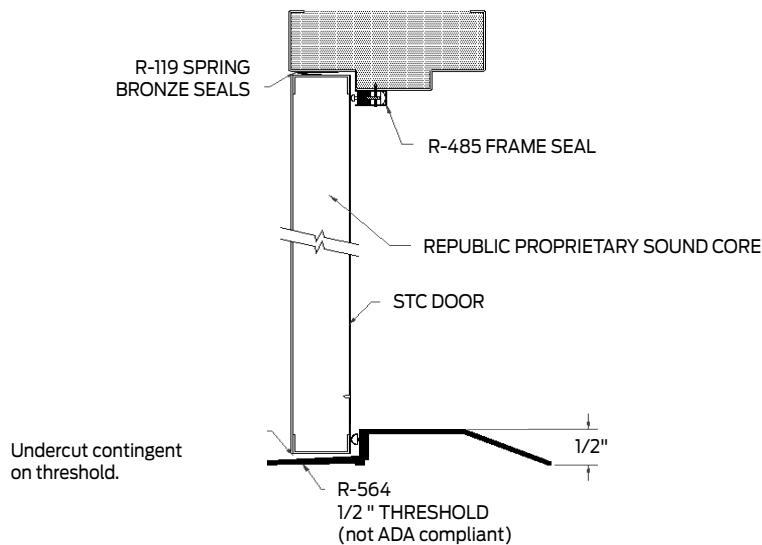
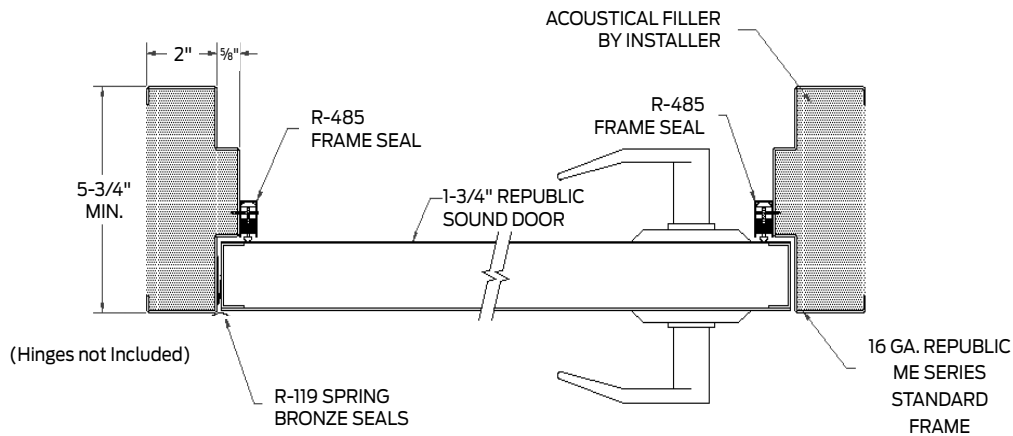

LEADLINED

BULLET RESISTANT

DF SERIES

HURRICANE/WIND RESISTANT

SOUND TRANSMISSION CONTROL

SINGLES - UNIVERSAL X 7/16" SINGLE RETURN											
Flush				16 Gauge				14 Gauge			
STC	Width	Height	Door	5-3/4"	5-7/8" thru 8-3/4"	8-7/8" thru 14-3/4"	14-7/8" thru 20"	5-3/4"	5-7/8" thru 8-3/4"	8-7/8" thru 14-3/4"	14-7/8" thru 20"
42	2'0" – 3'0"	7'0"	\$2,277	\$419	\$529	\$634	\$773	\$490	\$611	\$727	\$862
	Over 3'0" – 4'0"		\$2,642	\$435	\$535	\$644	\$781	\$505	\$626	\$734	\$868
43 or 47	Thru 3'0"		\$3,114	\$419	\$529	\$634	\$773	\$490	\$611	\$727	\$862
	Over 3'0" – 4'0"		\$3,453	\$435	\$535	\$644	\$781	\$505	\$626	\$734	\$868
42	Thru 3'0"	8'0"	\$2,630	\$490	\$588	\$692	\$831	\$569	\$677	\$792	\$928
	Over 3'0" – 4'0"		\$2,912	\$504	\$592	\$699	\$838	\$584	\$692	\$798	\$934
43 or 47	Thru 3'0"		\$3,437	\$490	\$529	\$692	\$831	\$569	\$677	\$792	\$928
	Over 3'0" – 4'0"		\$3,723	\$504	\$592	\$699	\$838	\$584	\$692	\$798	\$934

Note: STC Frames are priced 7/16" Single Return, CRS, Face Welded construction. Frames must be fully grouted or filled with sound deadening insulation (by others.) Doors are priced 16 gauge, CRS, Steel Stiffened core and 3/8" undercut. STC 42 units available with knock down frame, deduct \$58.00 per frame from above price, and are honeycomb core as standard.

SINGLES - 1/2" DOUBLE RETURN											
Flush				16 Gauge				14 Gauge			
STC	Width	Height	Door	5-7/8"	6" thru 8-1/4"	8-3/8" thru 13-7/8"	14" thru 20"	5-7/8"	6" thru 8-1/4"	8-3/8" thru 13-7/8"	14" thru 20"
42	2'0" – 3'0"	7'0"	\$2,277	\$434	\$574	\$689	\$842	\$530	\$664	\$792	\$940
	Over 3'0" – 4'0"		\$2,642	\$447	\$581	\$695	\$851	\$547	\$678	\$798	\$948
43 or 47	Thru 3'0"		\$3,114	\$434	\$574	\$689	\$842	\$530	\$664	\$792	\$940
	Over 3'0" – 4'0"		\$3,453	\$447	\$581	\$695	\$851	\$547	\$678	\$798	\$948
42	Thru 3'0"	8'0"	\$2,630	\$513	\$636	\$752	\$903	\$616	\$736	\$862	\$1,011
	Over 3'0" – 4'0"		\$2,912	\$527	\$644	\$759	\$914	\$631	\$751	\$868	\$1,018
43 or 47	Thru 3'0"		\$3,437	\$513	\$636	\$752	\$903	\$616	\$736	\$862	\$1,011
	Over 3'0" – 4'0"		\$3,723	\$527	\$644	\$759	\$914	\$631	\$751	\$868	\$1,018

1. STC Frames are priced 1/2" Double Return, CRS, Face Welded construction. Frames must be fully grouted or filled with sound deadening insulation (by others.) Doors are priced 16 gauge, CRS, Steel Stiffened core and 3/8" undercut.
2. STC 42 units available with knock down frame, deduct \$58.00 per frame from above price, and are honeycomb core as standard.
3. STC 42 to 47 Hardware Package (Included in price)

SINGLE (EMBOSSED 6 PANEL)			
STC	Width	Height	Door
40	Thru 3'0"	7'0"	\$3,143
	Over 3'0" – 3'6"		\$3,267
40	Thru 3'0"	8'0"	\$3,381
	Over 3'0" – 3'6"		\$3,532

STC 40 EMBOSSED 6 PANEL NOTES
Temperature Rise core included in price
Does not require or include hardware package
Standard 3/4" undercut

- Doors are available from STC 33 to STC 47
- Standard hollow metal frames (min. 5-3/4" frame depth) - welded. KD available on 40 and 42.
- SDI Level 3 - Maximum Duty - Performance Level A
- Fire rated available 40, 42 only
- Sound resistant septum (proprietary construction)
- All doors tested in fully operable conditions

### Testing and Qualifications:

All door systems tested in accordance with:

- ASTM E 90-04
- ASTM E 413-04
- ASTM E 1332-90
- ASTM E 2235-04

Testing was performed by:  
Architectural Testing Inc. and  
Riverbank Acoustical Laboratories



STEEL TYPES		
Description	Door	Frame
Cold rolled steel	Included	Included
A60 Galvanized steel	\$105.00	\$56.00
G90 Galvanized steel (14 and 16 gauge only)	\$419.00	\$102.00

HINGE PREPARATIONS		
Description	Door	Frame
Special hinge locations	No charge	No charge
4-1/2" or 5" Universal hinge prep	No charge	No charge
Additional hinge prep (per hinge)	\$25.00	\$23.00
Electric hinge <ul style="list-style-type: none"> <li>▪ Cutout in one hinge reinf.</li> <li>▪ No junction box or conduit</li> </ul>	\$25.00	\$22.00
Power transfer (no junction box or conduit)	\$131.00	\$104.00
8" Junction box welded in	N/A	\$33.00
10" Junction box welded in soffit	N/A	\$33.00
14" Junction box welded in soffit	N/A	\$33.00

DOOR - LOCK/FRAME - STRIKE PREPARATIONS		
Description	Door	Frame
Standard lock (strike) at non-standard location	No charge	No charge
Cylindrical dead lock (2-3/4" strike)	\$61.00	\$23.00
Mortise dead lock (3-1/2" strike)	\$61.00	\$23.00
Electric strike (no junction box or conduit)	\$135.00	\$68.00
Rim reinforcement only <sup>1</sup>	\$50.00	\$30.00
Rim reinforcement with function prep	\$56.00	N/A
Mortise exit device reinforcement with function prep	\$89.00	N/A
Surface vertical rod reinforcement only <sup>1</sup>	\$82.00	\$30.00
Concealed vertical rod (strike) (per prep)	\$611.00	N/A
Exit alarm reinforcement only <sup>1</sup>	\$62.00	\$30.00

1. Republic Tested Acoustical Systems – tested with standard hardware applications. Surface applied hardware not recommended due to possible interference with seals and gaskets. Any break or tear in seals and gaskets may affect performance.

FRAME PROFILE OPTIONS		
Description	Door	Frame
Single rabbet (minimum depth on STC is 5-3/4")	N/A	No charge
4" Face heads (through 4'0")	N/A	\$59.00
4" Face heads (over 4'0")	N/A	\$83.00

See [Engineering Section](#) for further options and/or details.

LABEL PREPARATIONS		
Description	Door	Frame
Mark numbers	No charge	No charge
U.L. Metal Fire label <sup>1</sup>	\$48.00	\$29.00
ITS/Warnock Hersey Metal Fire label <sup>1</sup>	\$48.00	\$29.00

1. STC 40 and 42 only.

CLOSER PREPARATIONS		
Description	Door	Frame
Closer reinforcement	\$37.00	\$29.00
Concealed overhead door closer, holder or stop	\$371.00	\$289.00

SPECIAL FINISH		
Description	Door	Frame
Second coat of primer	\$124.00	\$109.00
Finish paint setup charge	\$1,350.00	\$1,350.00
Finish paint <ul style="list-style-type: none"> <li>▪ Minimum quantity 20 doors or 20 (3pc) frames per color</li> <li>▪ Price includes full carton wrap</li> </ul>	\$274.00	\$274.00

ANCHOR OPTIONS		
Description	Door	Frame
Welded in prepared opening anchor (per anchor)	N/A	\$16.00
Welded in anchor (per anchor)	N/A	\$7.00
Punch and dimple only (per prep)	N/A	\$5.50

FRAME CONSTRUCTION		
Description	Door	Frame
Unit bundle (3pc)	N/A	\$7.00
Standard face weld (3pc)	N/A	Included
Full profile weld (3pc)	N/A	\$208.00

SPECIAL CONSTRUCTIONS		
Description	Door	Frame
10 Gauge hinge and 14 gauge lock channels	\$156.00	N/A
Seal top or bottom channel and finish smooth each	\$142.00	N/A
Mag switch/DPS - Hole only	\$23.00	\$22.00
Mag switch/DPS - Prep and reinf. (no junction box)	\$123.00	\$90.00
Continuous welded edge	\$169.00	N/A
Bondo filled edge	\$115.00	N/A
Beveled lock edge (1/8" in 2")	\$23.00	N/A
Door viewer	\$30.00	N/A
Conduit/raceway - includes wire pull	\$190.00	N/A

DOOR TEST PERFORMANCE CHARACTERISTICS PER ASTM E90 AND E413																		
STC	Transmission Loss in db/Hertz																	
	100	125	160	200	250	315	400	500	630	800	1000	1250	1600	2000	2500	3150	4000	5000
38	26	23	27	33	36	35	34	34	39	41	42	44	45	47	45	45	45	45
42	32	28	32	36	35	37	36	38	38	40	42	43	44	45	49	54	56	54

### SOUND TRANSMISSION CONTROL (STC) 48 - 50 - 52 AND STC 47 PAIRS

#### Specialty

refer to technical data sheet on page 14

#### SOUND TRANSMISSION CONTROL (STC) 48

- Thickness – 1-3/4" (+/- 1/16")
- Actual Door Size – Door undersized from nominal by 1/4" in width and 3/8" in height. Standard undercut is 1/4". Undercut is contingent on threshold.
- Hinge Rail and Reinforcement – Hinge edge is non-beveled and reinforced with a continuous 16 gauge steel channel projection welded to each skin at a maximum of 5" on center. Hinge channels have an additional 9 gauge reinforcement at each hinge location, providing over 3/16" reinforcement (Backset 1/4")
- Core – Special Sound Core
- Closer Reinforcement (Req'd) – 14 gauge std
- Lock Rail – Lock edge is non-beveled and reinforced with a continuous 16 gauge steel channel. 16 gauge reinforcements for mortised or cylindrical locks are of an integral type in accordance with ANSI A115 standards.
- Top Channel – Top channel is flush 16 gauge channel, projection welded at a maximum of 2-1/2" on center
- Bottom Channel – Bottom channel is 16 gauge flush, projection welded at a maximum of 2-1/2" on center
- Face skin – 16 gauge – Cold Roll Steel, A60 Galvanneal or G90 Galvanized
- Size Availability – Maximum 4'0" x 8'0"
- SDI 100 Grade/Model – Grade 3/Model 2 (Physical Performance Level A)
- Edge Seam Construction – Intermittently welded edge seam (Optional - Continuous welded edge seam)
- Universal Standard/Heavy Weight Hinge – Hinge fillers are used allowing for an easy modification from standard to heavy weight hinge prep – 5" hinges standard
- Handing Design – Non-Handed standard/Optional Handed design

#### SOUND TRANSMISSION CONTROL (STC) 50 and 52

- Thickness – 1-13/16" (+/- 1/16")
- Actual Door Size – Door undersized from nominal by 1/4" in width and 3/8" in height. Standard undercut is 1/4". Undercut is contingent on threshold.
- Hinge Rail and Reinforcement – Hinge edge is non-beveled and reinforced with a continuous 10 gauge steel channel projection welded to each skin at a maximum of 5" on center.
- Core – Special Sound Core
- Lock Rail – Lock edge is non-beveled and reinforced with a continuous 14 gauge steel channel projection welded at a maximum of 5" on center.
- Top Channel – Top channel is flush 16 gauge channel, projection welded at a maximum of 2-1/2" on center
- Bottom Channel – Bottom channel is 16 gauge flush, projection welded at a maximum of 2-1/2" on center
- Face skin – 14 gauge – Cold Roll Steel, A60 Galvanneal or G90 Galvanized
- Closer Reinforcement (Req'd) – 14 gauge std
- Size Availability – Maximum 4'0" x 8'0"
- SDI 100 Grade/Model – Grade 4/Model 2 (Physical Performance Level A)
- Edge Seam Construction – Intermittently welded edge seam standard. (Optional - continuous welded edge seam)

**Note:** STC Pairs available – Maximum rating 47

#### SECTION 08348 ACOUSTIC STEEL DOOR AND FRAME ASSEMBLY

PART 1 - GENERAL	PART 2 - PRODUCTS
<b>Quality Assurance</b>	<b>Materials</b>
Sound Rating: Certify that the construction is identical to the Sound Transmission Classification (STC) assembly tested at an independent acoustical laboratory qualified under NVLAP by the National Institute for Science and Technology (NIST) according to ASTM E90 and that the STC rating according to ASTM E413 is not less than that specified or scheduled. Minimum STC rating shall be one of the following: 48, 50, 52.	<ul style="list-style-type: none"> <li>▪ All steels used to manufacture doors, frames, anchors and accessories shall be in accordance with SDI-100/ANSI A250.8.</li> <li>▪ Door Core - shall be manufacturer's proprietary standard core to achieve specified ratings.</li> <li>▪ Shop primer shall be manufacturer's standard rust inhibitive baked on or air dried shop primer.</li> <li>▪ Door seals shall be manufacturer's standard adjustable sound seals.</li> <li>▪ Hardware shall be manufacturer's standard Cam-Lift hinges, door bottom, threshold, seals and gaskets (when required).</li> </ul>
<b>Warranty</b>	<b>Fabrication</b>
Material and workmanship shall be warranted by manufacturer for a period of one (1) year from the date of shipment. Warranty shall apply to replacement or retrofit of product only.	<ul style="list-style-type: none"> <li>▪ Doors shall be minimum 14 gauge (STC 50 and 52 = 1-13/16"), 16 gauge (STC 48 = 1-3/4"), (nominal), without visible joints on exposed faces. Reinforce top and bottom with "flush" steel channels of no less than 16 gauge.</li> <li>▪ Door core shall be proprietary acoustic composite core as tested by manufacturer to meet specified STC rating.</li> <li>▪ Frames shall be minimum 16 gauge for STC 48, 14 gauge for STC 50 and 52, face welded and ground smooth construction. Provide frames with minimum of three anchors per jamb suitable for adjoining wall construction.</li> <li>▪ All frames shall be fully prepared for mortised hardware and reinforced only for surface mounted hardware. Drilling and/or tapping shall be completed by others.</li> <li>▪ Acoustical Seals shall be manufactured by ZERO International or Pemko.</li> </ul>
<b>Approved Manufacturers</b>	
Republic Doors and Frames 155 Republic Drive McKenzie TN 38201 Phone: 800-733-3667 Fax: 800-723-6677	

INSTALLATION INSTRUCTIONS FOR ACOUSTIC GASKETS

Republic's tested STC system included: R-566 threshold, R-870 adjustable head and jamb seals, R-119 spring bronze head and jamb seals.

1. The R-119 spring bronze should be installed on the bottom of the door before hanging.
2. Install the R-566 threshold to suit floor condition. Caulk round the bottom of threshold along with the entire perimeter of frame and at meeting edges of threshold and frame.
3. Close the door and measure the frame opening width and height. Install the R-870 head piece first (trim as necessary). Place the piece against the face of the door, making gentle contact between the "rubber extrusion" seal and the door, then fasten in place. Place the hinge side seal against the face of the door, making gentle contact between the "rubber extrusion" seal and the door, then fasten in place. Place the strike side seal against the face of the door, making gentle contact between the rubber extrusion seal and the door, then fasten in place.
4. Install the R-119, head piece first, then the hinge side and finally the lock side using the pressure sensitive tape to fasten the spring bronze to the frame.
5. Adjust the R-870 with the adjustment screws for the desired seal and operation of the door.
6. Check operation of the door after each piece of material is installed to make sure that no binding is taking place.

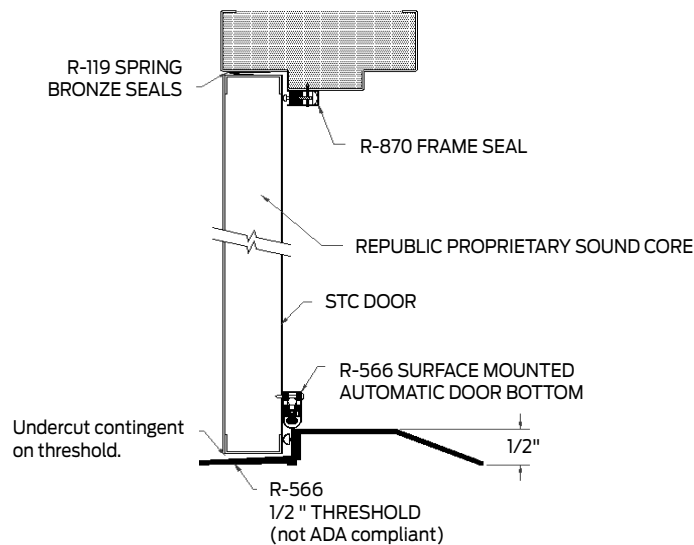
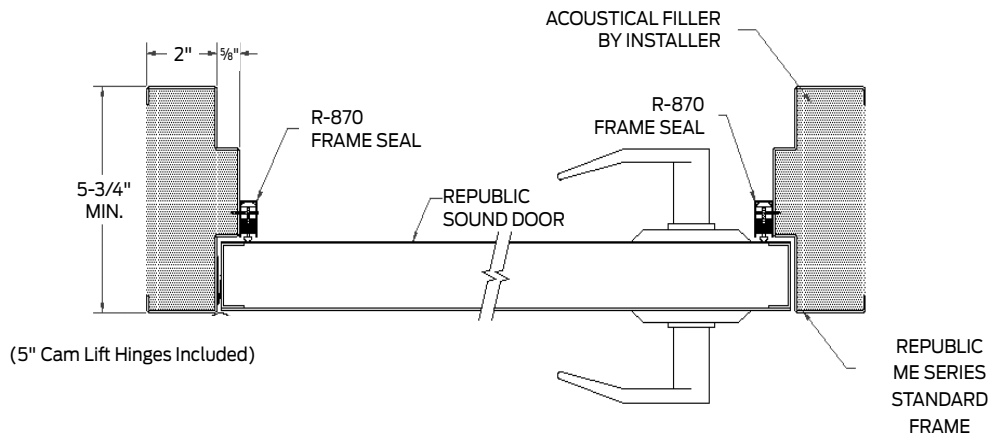

LEADLINED

BULLET RESISTANT

DF SERIES

HURRICANE/WIND RESISTANT

SOUND TRANSMISSION CONTROL

SINGLES - 14 GAUGE <sup>1</sup>											
Flush				Universal x 7/16" Single Return <sup>2</sup>				DW x 1/2" Double Return <sup>3</sup>			
STC	Width	Height	Door	5-3/4"	5-7/8" thru 8-3/4"	8-7/8" thru 14-3/4"	14-7/8" thru 20"	5-3/4"	5-7/8" thru 8-3/4"	8-7/8" thru 14-3/4"	14-7/8" thru 20"
48	Thru 3'0"	7'0"	\$4,714	\$556	\$678	\$793	\$929	\$596	\$731	\$857	\$1,006
	Over 3'0" - 4'0"		\$5,080	\$571	\$692	\$800	\$934	\$613	\$746	\$865	\$1,014
50	Thru 3'0"		\$5,177	\$556	\$678	\$793	\$929	\$596	\$731	\$857	\$1,006
	Over 3'0" - 4'0"		\$5,500	\$571	\$692	\$800	\$934	\$613	\$746	\$865	\$1,014
52	Thru 3'0"		\$5,248	\$556	\$678	\$793	\$929	\$596	\$731	\$857	\$1,006
	Over 3'0" - 4'0"		\$5,570	\$571	\$692	\$800	\$934	\$613	\$746	\$865	\$1,014
48	Thru 3'0"	8'0"	\$5,092	\$655	\$766	\$880	\$1,015	\$706	\$824	\$951	\$1,099
	Over 3'0" - 4'0"		\$5,377	\$672	\$779	\$888	\$1,023	\$721	\$839	\$958	\$1,107
50	Thru 3'0"		\$5,681	\$655	\$766	\$880	\$1,015	\$706	\$824	\$951	\$1,099
	Over 3'0" - 4'0"		\$6,004	\$672	\$779	\$888	\$1,023	\$721	\$839	\$958	\$1,107
52	Thru 3'0"		\$5,753	\$655	\$766	\$880	\$1,015	\$706	\$824	\$951	\$1,099
	Over 3'0" - 4'0"		\$6,074	\$704	\$816	\$931	\$1,072	\$756	\$880	\$1,004	\$1,161

1. Frames must be fully grouted or filled with sound deadening insulation (by others.) Doors are priced CRS, Steel Stiffened core, Seamless edge design, 16 gauge for STC rating 48 - STC 50 and 52 are 14 gauge. Materials are prepped for 5.0" Heavy Weight hinges. Doors have a 1/4" undercut due to threshold requirements. STC units prepped at 5-10=Equal hinge spacing.
2. STC 48 to 52 frames are priced 7/16" Single Return, CRS, Face Welded construction.
3. STC 48 to 52 frames are priced 1/2" Double Return, 14 gauge, CRS, Face Welded construction.

DOUBLES - 14 GAUGE (MAXIMUM STC RATING 47)											
Flush				Univ x 7/16" Single Return				DW x 1/2" Double Return			
STC	Width	Height	Door	5-3/4"	5-7/8" thru 8-3/4"	8-7/8" thru 14-3/4"	14-7/8" thru 20"	5-7/8"	6" thru 8-1/4"	8-3/8" thru 13-7/8"	14" thru 20"
47	Thru 6'0"	7'0"	\$10,354	\$653	\$778	\$890	\$1,025	\$706	\$839	\$967	\$1,111
	Over 6'0" - 8'0"		\$10,998	\$664	\$798	\$909	\$1,045	\$715	\$864	\$987	\$1,134
47	Thru 6'0"	8'0"	\$11,362	\$766	\$880	\$991	\$1,127	\$828	\$951	\$1,074	\$1,222
	Over 6'0" - 8'0"		\$12,008	\$777	\$900	\$1,011	\$1,145	\$835	\$974	\$1,096	\$1,242

- Doors are available from STC 48 to STC 52
- Standard hollow metal frames (min. 5-3/4" frame depth - welded)
- Flush top and bottom channel
- SDI Level 3 and 4 - Maximum Duty - Performance Level A
- Sound-resistant septum (proprietary construction)
- STC 48 and above furnished complete with all perimeter seals, 5" Cam-lift hinges and threshold and door bottom
- Pairs available up to STC 47
- All doors tested in fully operable conditions

### Testing and Qualifications:

All door systems tested in accordance with:

- ASTM E 90-04
- ASTM E 413-04
- ASTM E 1332-90
- ASTM E 2235-04

Testing was performed by:  
Architectural Testing Inc. and  
Riverbank Acoustical Laboratories

STEEL TYPES		
Description	Door	Frame
Cold rolled steel	Included	Included
A60 Galvanized steel	\$105.00	\$56.00
G90 Galvanized steel (14 and 16 gauge only)	\$419.00	\$102.00

HINGE PREPARATIONS		
Description	Door	Frame
Special hinge locations	No charge	No charge
Additional hinge prep (per hinge)	\$25.00	\$23.00
5" Standard or heavy weight hinge prep (each)	Included	Included
Electric hinge <ul style="list-style-type: none"> <li>▪ Cutout in one hinge reinf.</li> <li>▪ No junction box or conduit</li> </ul>	\$25.00	\$22.00
Power transfer (no junction box or conduit)	\$131.00	\$104.00
8" Junction box welded in	N/A	\$33.00
14" Junction box welded in	N/A	\$33.00
10" Junction box welded in soffit	N/A	\$33.00

DOOR - LOCK/FRAME - STRIKE PREPARATIONS		
Description	Door	Frame
Standard lock (strike) at non-standard location	No charge	No charge
Cylindrical dead lock (2-3/4" strike)	\$61.00	\$23.00
Mortise dead lock (3-1/2" strike)	\$61.00	\$23.00
Electric strike (no junction box or conduit)	\$135.00	\$68.00
Rim reinforcement only <sup>1</sup>	\$50.00	\$30.00
Mortise exit device reinforcement with function prep	\$89.00	N/A
Surface vertical rod reinforcement only <sup>1</sup>	\$82.00	\$30.00
Concealed vertical rod (strike)	\$611.00	N/A
Exit alarm reinforcement only <sup>1</sup>	\$62.00	\$30.00

1. Republic Tested Acoustical Systems – tested with standard hardware applications. Surface-applied hardware not recommended due to possible interference with seals and gaskets. Any break or tear in seals and gaskets may affect performance.

FRAME PROFILE OPTIONS		
Description	Door	Frame
Single rabbet (minimum depth on STC is 5-3/4")	N/A	No charge
4" Face heads (through 4'0")	N/A	\$59.00
4" Face heads (over 4'0")	N/A	\$83.00

See [Engineering Section](#) for further options and/or details.

LABEL PREPARATIONS		
Description	Door	Frame
Mark numbers	No charge	No charge
U.L. Mylar label (std unless specified otherwise)	N/A	N/A
U.L. Metal label	N/A	N/A
Warnock Hersey Metal label	N/A	N/A
STC labels with gasketing (lab tested)	Included	Included

CLOSER PREPARATIONS		
Description	Door	Frame
Closer reinforcement	\$37.00	\$29.00
Concealed overhead door closer, holder or stop	\$371.00	\$289.00

SPECIAL FINISH		
Description	Door	Frame
Second coat of primer	\$124.00	\$109.00
Finish paint setup charge	\$1,350.00	\$1,350.00
Finish paint <ul style="list-style-type: none"> <li>▪ Minimum quantity of 20 doors or 20 (3pc) frames per color</li> <li>▪ Price includes full carton wrap</li> </ul>	\$274.00	\$274.00

ANCHOR OPTIONS		
Description	Door	Frame
Welded in prepared opening anchor (per anchor)	N/A	\$16.00
Welded in anchor (per anchor)	N/A	\$7.00
Punch and dimple only (per P&D)	N/A	\$5.50

FRAME CONSTRUCTION		
Description	Door	Frame
Unit bundle (3pc)	N/A	\$7.00
Standard face weld (3pc)	N/A	Included
Full profile weld (3pc)	N/A	\$208.00

SPECIAL CONSTRUCTIONS		
Description	Door	Frame
10 Gauge hinge and 14 gauge lock channels	N/A	N/A
Seal top or bottom channel and finish smooth each	\$142.00	N/A
Mag switch/DPS - Hole only	\$23.00	\$22.00
Mag switch/DPS - Prep and reinf. (no junction box)	\$123.00	\$90.00
Continuous welded edge	\$169.00	N/A
Bondo filled edge	Included	N/A
Beveled lock edge (1/8" in 2") STC 48 only	\$23.00	N/A
Door viewer	\$30.00	N/A
Conduit/raceway - includes wire pull	\$190.00	N/A

DOOR TEST PERFORMANCE CHARACTERISTICS PER ASTM E90 AND E413																		
STC	Transmission Loss in db/Hertz																	
	100	125	160	200	250	315	400	500	630	800	1000	1250	1600	2000	2500	3150	4000	5000
48	24	29	34	40	37	41	43	42	45	50	50	53	53	54	53	54	55	54
50	19	30	36	40	42	45	46	42	49	50	50	51	53	54	56	57	55	55
52	21	29	36	40	44	46	47	44	53	54	54	55	55	56	57	59	59	58

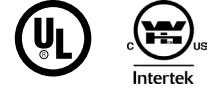

## SE SERIES

### Universal Sticks

refer to technical data sheet on page 13

Republic pre-engineered steel frame components called "sticks" provide unlimited flexibility for opening systems. Stick components are used to fabricate even the most complex entrance fronts, partitions and window wall designs. The variety of jamb depths and sizes permit greater design freedom. Because stick assemblies are normally welded, they offer strength without seams showing between vertical and horizontal members.

These openings can be designed for any job requirement, fabricated from factory components, assembled and welded by factory trained Republic Distributors. Because sticks can be shipped as components and fabricated locally, shipping costs, job delays and design limitations are greatly reduced.

Frame assemblies shall be made of standard stick components, fabricated from prime quality 16, 14 or 12 gauge, cold-rolled or galvanized steel. Where sticks are used at door openings in the frame assemblies, they shall be prepared for all hardware specified. Frame assemblies shall be fabricated from three basic components: Open sections (perimeter members), Mullion sections (intermediate members) and Sill sections (bottom members).

Mullion sections shall have identical jamb depths and stops as open sections. Mullion sections are only available in 16 and 14 gauge.

Sill sections shall be flush with both faces of adjacent vertical members. The individual sticks shall be cut to length and notched to assure square joints and corners. All joints and corners of the frame assembly available welded and ground smooth at the face of the sections.

When specified, steel panels shall be furnished 1-3/8" or 1-3/4" thick as required.

All stick components, steel panels and frame assemblies shall be phosphatized and receive one coat of force-cured rust inhibiting prime paint. Steel channel glazing beads shall be provided with the assemblies for all areas in which glass is to be installed.

Frame assemblies may be shipped to jobsite completely welded. Field joints shall be permitted only when the size of the total assembly exceeds shipping limitations. When frame assemblies are subjected to windloads, vertical members shall be free of field splices.

Sticks are manufactured in 10'3" maximum lengths. Other lengths are available. Consult factory.

Other profiles are available upon request.

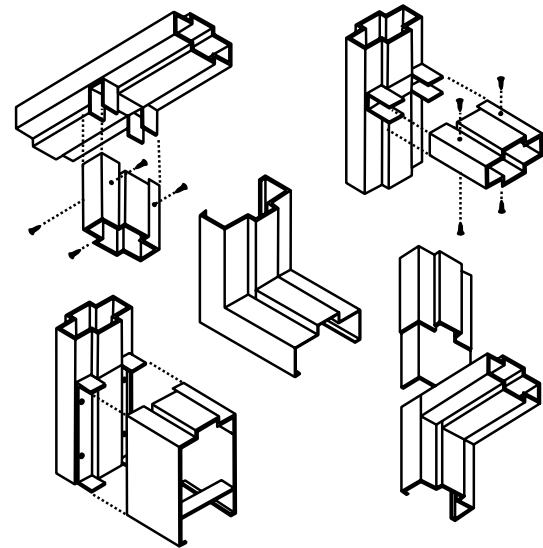
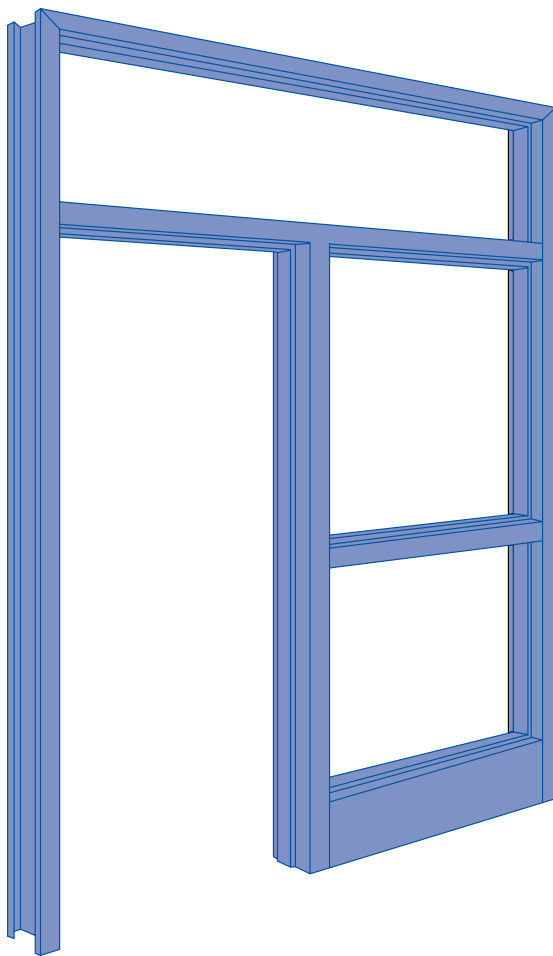

Section Details of Typical Field Splice Connections

SE SERIES

BORROWED LITES

CUT-N-NOTCH AND PANELS

## Jams (Open Sections)

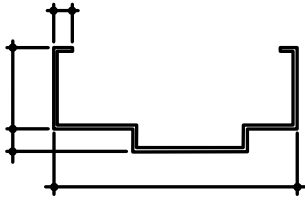

Blank Jamb

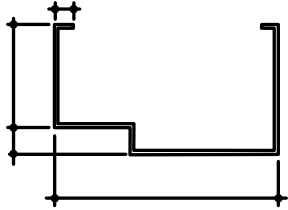

Blank Jamb Single Rabbet

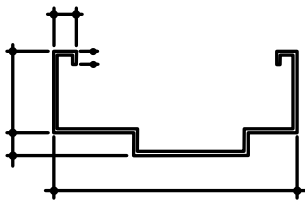

Blank Jamb Drywall Return

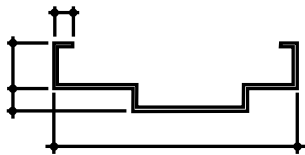

Blank Jamb Non Standard Face

## Bases (Sill Section)

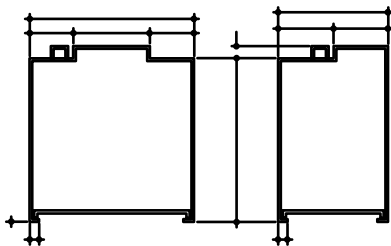

## Mullions (Closed Sections)

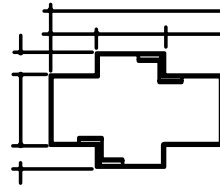

Blank Mullion

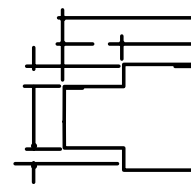

Blank Mullion Single Rabbet

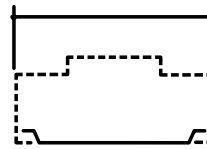

Blank Jamb Filler No Stop



Blank Jamb Filler With Stop

## Mullions (Closed Sections)

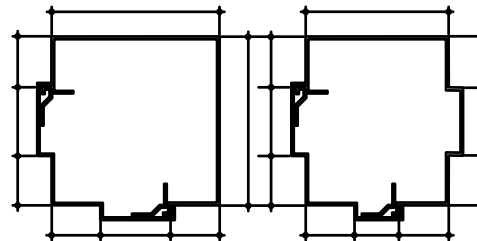

2 Way

3 Way

UNIVERSAL (SE) STICKS 7/16" SINGLE RETURN													
Description	Height	16 Gauge						14 Gauge					
		4-5/8" thru 5-7/8"	6" thru 7-7/8"	8" thru 9-7/8"	10" thru 11-7/8"	12" thru 14-3/4"	14-7/8" thru 20"	4-5/8" thru 5-7/8"	6" thru 7-7/8"	8" thru 9-7/8"	10" thru 11-7/8"	12" thru 14-3/4"	14-7/8" thru 20"
Blank jamb	10'3"	\$172	\$187	\$237	\$282	\$343	\$429	\$202	\$232	\$295	\$333	\$410	\$513
Hinge jamb 4.5" Hng preps	10'3"	\$241	\$256	\$306	\$351	\$412	\$498	\$271	\$301	\$364	\$402	\$479	\$582
Strike jamb asa/4-7/8" stk	10'3"	\$195	\$210	\$260	\$305	\$366	\$452	\$225	\$255	\$318	\$356	\$433	\$536
Filler w/stop	10'3"	\$191	\$211	\$223	\$248	\$301	\$376	\$222	\$237	\$251	\$295	\$371	\$463
Filler w/o stop	10'3"	\$123	\$154	\$165	\$189	\$215	\$297	\$152	\$189	\$199	\$232	\$266	\$349
Blank jamb 4" face	10'3"	\$229	\$249	\$316	\$371	\$451	\$564	\$267	\$290	\$374	\$418	\$527	\$659
Blank jamb 6" face	10'3"	\$400	\$501	\$541	\$575	\$635	\$812	\$498	\$592	\$674	\$707	\$791	\$1,014
Blank jamb 8" face	10'3"	\$400	\$501	\$541	\$575	\$635	\$812	\$498	\$592	\$674	\$707	\$791	\$1,014
Blank jamb 10" face	10'3"	\$473	\$560	\$600	\$680	\$783	\$980	\$555	\$629	\$700	\$768	\$952	\$1,196
Blank jamb 12" face	10'3"	\$473	\$560	\$600	\$680	\$783	\$980	\$555	\$629	\$700	\$768	\$952	\$1,196
Blank jamb cased open	10'3"	\$172	\$187	\$237	\$282	\$343	\$429	\$202	\$232	\$295	\$333	\$410	\$513
Dbt egress blank jamb minimum JD 4-3/4"	10'3"	\$231	\$266	\$275	\$320	\$369	\$454	\$295	\$335	\$354	\$400	\$452	\$535
Dbt egress hinge jamb 4.5" Hng preps minimum JD 4-3/4"	10'3"	\$300	\$335	\$344	\$389	\$438	\$523	\$364	\$404	\$423	\$469	\$521	\$604
Blank mullion 2" face	10'3"	\$381	\$434	\$483	\$563	\$676	\$845	\$440	\$536	\$585	\$664	\$788	\$985
Blank mullion 4" face	10'3"	\$494	\$571	\$635	\$737	\$841	\$1,052	\$565	\$680	\$738	\$852	\$980	\$1,225
Blank mullion 6" face	10'3"	\$632	\$717	\$778	\$882	\$1,053	\$1,316	\$715	\$791	\$875	\$981	\$1,191	\$1,488
Blank mullion 8" face	10'3"	\$632	\$717	\$778	\$882	\$1,053	\$1,316	\$715	\$791	\$875	\$981	\$1,191	\$1,488
Blank mullion 10" face	10'3"	\$677	\$767	\$832	\$945	\$1,125	\$1,407	\$735	\$852	\$936	\$1,001	\$1,253	\$1,566
Blank mullion 12" face	10'3"	\$677	\$767	\$832	\$945	\$1,125	\$1,407	\$735	\$852	\$936	\$1,001	\$1,253	\$1,566
Hinge mullion 4.5" Hng preps	10'3"	\$444	\$497	\$546	\$626	\$739	\$908	\$497	\$593	\$642	\$721	\$845	\$1,042
Strike mullion	10'3"	\$400	\$453	\$502	\$582	\$695	\$864	\$459	\$555	\$604	\$683	\$807	\$1,004
2 Way corner post	10'3"	\$723	\$764	\$797	\$929	\$1,101	\$1,376	\$787	\$844	\$942	\$1,053	\$1,236	\$1,545
3 Way corner post	10'3"	\$723	\$764	\$797	\$929	\$1,101	\$1,376	\$787	\$844	\$942	\$1,053	\$1,236	\$1,545

FRAME PROFILE OPTIONS	
No returns	No charge
Cased open	No charge
Single rabbet	No charge
Non-standard face (per piece) (1"-3-7/8" uniform)	\$65.00
Non-standard face (per piece) (1"-3-7/8" unequal)	\$65.00
Non-standard rabbet (per piece)	\$62.00
Kerf (includes weather-stripping)	\$183.00
Non-standard returns (uniform)	\$65.00

HINGE PREPARATIONS	
Special hinge locations	No charge
4-1/2" Heavy weight hinge prep	No charge
Additional hinge prep (per hinge)	\$23.00
5" Standard or heavy weight hinge prep (per hinge)	No charge

STEEL TYPES	
Cold rolled steel	Included
A60 Galvanized steel - Jamb/Stick	\$56.00
A60 Galvanized steel - Mullion	\$56.00
G90 Galvanized steel (14 and 16 gauge only) - Jamb/Stick	\$102.00
G90 Galvanized steel (14 and 16 gauge only) - Mullion	\$102.00
12 Gauge - Jamb/Stick (N/A on mullions or drywall) (Add to 14 gauge) *5/8 returns	\$375.00

FRAME - STRIKE PREPARATIONS	
Special strike location	No charge
Standard strike at non-standard location	No charge
Cylindrical dead lock (2-3/4" strike)	\$23.00
Mortise dead lock (3-1/2" strike)	\$23.00
ANSI 4-7/8" Strike - any location	\$23.00

See [Engineering Section](#) for further options and/or details.



## ME/MH SERIES

### Borrowed Lites

#### ME SERIES

- Gauges – 16 and 14
- Faces – 1" to 4"
- Standard Rabbets – 1-9/16" and 1-15/16"
- Stop – 5/8" standard
- Single Return – 7/16" x Universal/Masonry profile
- Anchors – See Details
- Profiles – Equal Rabbet, Unequal Rabbet, Single Rabbet

#### MH SERIES

- Gauges – 16 and 14
- Faces – 1" to 4"
- Standard Rabbets – 1-9/16" and 1-15/16"
- Stop – 5/8" standard
- Double Return – 1/2" x Drywall profile
- Anchors - Drywall – Welded in compression anchors 3-1/2" in from each end standard
- Profiles – Equal Rabbet, Unequal Rabbet, Single Rabbet

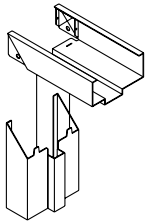

ME Corner Connection

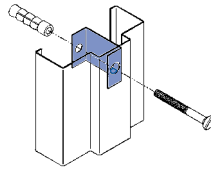

Prepared Opening Anchor

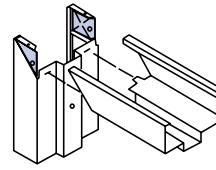

MH Corner Connection

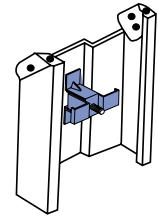

Compression Anchor (Standard)

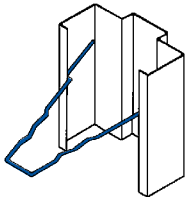

Wire Anchor

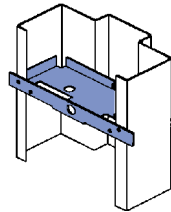

Wood Stud Anchor

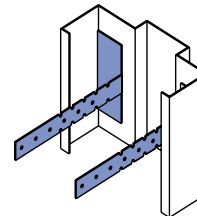

L Strap Anchor (Optional)

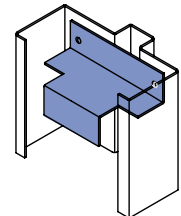

"Z" Anchor (Optional)  
Must be welded in

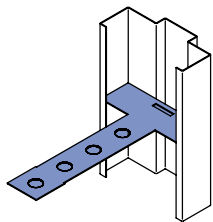

"T" Anchor

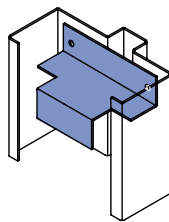

"Z" Anchor

COMPONENTS UNIVERSAL FRAMES 7/16" SINGLE RETURN												
Header (Borrowed Lites require 2 each)	16 Gauge						14 Gauge					
	4-5/8" thru 5-7/8"	6" thru 7-7/8"	8" thru 9-7/8"	10" thru 11-7/8"	12" thru 14-3/4"	14-7/8" thru 20"	4-5/8" thru 5-7/8"	6" thru 7-7/8"	8" thru 9-7/8"	10" thru 11-7/8"	12" thru 14-3/4"	14-7/8" thru 20"
Thru 3'0"	\$55	\$63	\$72	\$85	\$108	\$168	\$75	\$81	\$97	\$111	\$140	\$200
Thru 4'0"	\$71	\$80	\$87	\$101	\$122	\$182	\$84	\$92	\$107	\$125	\$147	\$207
Thru 5'0"	\$101	\$107	\$116	\$131	\$153	\$213	\$119	\$132	\$144	\$165	\$183	\$243
Thru 6'0"	\$111	\$119	\$131	\$145	\$168	\$228	\$134	\$144	\$156	\$172	\$199	\$259
Thru 8'0"	\$135	\$145	\$162	\$175	\$200	\$260	\$160	\$172	\$187	\$210	\$236	\$296
Thru 10'0"	\$173	\$186	\$210	\$230	\$255	\$315	\$207	\$226	\$251	\$276	\$305	\$365

COMPONENTS UNIVERSAL FRAMES 7/16" SINGLE RETURN												
Jamb Pair	16 Gauge						14 Gauge					
Height	4-5/8" thru 5-3/4"	6" thru 7-7/8"	8" thru 9-7/8"	10" thru 11-7/8"	12" thru 14-3/4"	14-7/8" thru 20"	4-5/8" thru 5-3/4"	6" thru 7-7/8"	8" thru 9-7/8"	10" thru 11-7/8"	12" thru 14-3/4"	14-7/8" thru 20"
Thru 3'0"	\$166	\$175	\$206	\$235	\$272	\$325	\$185	\$204	\$242	\$266	\$313	\$377
Over 3'0" – 4'0"	\$200	\$212	\$253	\$290	\$339	\$409	\$224	\$249	\$316	\$330	\$393	\$477
Over 4'0" – 6'0"	\$238	\$258	\$290	\$318	\$368	\$488	\$286	\$306	\$328	\$372	\$428	\$548
Over 6'0" – 8'0"	\$336	\$344	\$370	\$406	\$468	\$588	\$390	\$402	\$422	\$464	\$528	\$648
Over 8'0" – 10'0"	\$440	\$464	\$494	\$536	\$614	\$734	\$504	\$522	\$556	\$594	\$688	\$808

COMPONENTS DRYWALL FRAMES 1/2" DOUBLE RETURN												
Header (Borrowed Lites require 2 each)	16 Gauge						14 Gauge					
	4-1/2" thru 5-7/8"	6" thru 7-7/8"	8" thru 9-7/8"	10" thru 11-7/8"	12" thru 14-3/4"	14-7/8" thru 20"	4-1/2" thru 5-7/8"	6" thru 7-7/8"	8" thru 9-7/8"	10" thru 11-7/8"	12" thru 14-3/4"	14-7/8" thru 20"
Thru 3'0"	\$57	\$73	\$84	\$97	\$123	\$183	\$81	\$91	\$101	\$113	\$141	\$201
Over 3'0" – 4'0"	\$72	\$89	\$96	\$113	\$134	\$194	\$89	\$105	\$110	\$133	\$149	\$209
Over 4'0" – 6'0"	\$110	\$118	\$132	\$145	\$169	\$229	\$145	\$156	\$164	\$181	\$200	\$260
Over 6'0" – 8'0"	\$132	\$143	\$157	\$173	\$200	\$260	\$176	\$187	\$197	\$212	\$240	\$300
Over 8'0" – 9'0"	\$151	\$173	\$195	\$213	\$240	\$300	\$187	\$204	\$224	\$242	\$269	\$329
Over 9'0" – 10'0"	\$191	\$226	\$253	\$274	\$306	\$366	\$253	\$272	\$293	\$311	\$339	\$399

COMPONENTS DRYWALL FRAMES 1/2" DOUBLE RETURN												
Jamb Pair	16 Gauge						14 Gauge					
Height	4-1/2" thru 5-7/8"	6" thru 7-7/8"	8" thru 9-7/8"	10" thru 11-7/8"	12" thru 14-3/4"	14-7/8" thru 20"	4-1/2" thru 5-7/8"	6" thru 7-7/8"	8" thru 9-7/8"	10" thru 11-7/8"	12" thru 14-3/4"	14-7/8" thru 20"
Thru 3'0"	\$225	\$235	\$266	\$294	\$331	\$384	\$244	\$263	\$301	\$325	\$373	\$436
Over 3'0" – 4'0"	\$259	\$271	\$312	\$349	\$398	\$468	\$283	\$308	\$359	\$390	\$453	\$536
Over 4'0" – 6'0"	\$256	\$296	\$324	\$356	\$412	\$532	\$324	\$378	\$392	\$442	\$514	\$634
Over 6'0" – 8'0"	\$346	\$384	\$414	\$454	\$516	\$636	\$422	\$466	\$500	\$534	\$604	\$724
Over 8'0" – 10'0"	\$494	\$520	\$568	\$590	\$662	\$782	\$572	\$626	\$660	\$698	\$768	\$888

Note: Drywall Borrowed Lite jamb pairs include 2 each compression anchors - welded in jamb(s). One at approximately 3.5" in from each end.

FRAME PROFILE OPTIONS	
No returns	No charge
Cased open	No charge
Single rabbet	No charge
4" Face heads (through 4'0")	\$59.00
4" Face heads (over 4'0")	\$83.00
Non-standard face (per frame) 1"-3-7/8" uniform	\$65.00
Non-standard rabbet	\$246.00
Non-standard returns (uniform)	\$65.00
Cold rolled steel	Included
A60 Galvanized steel	\$56.00
G90 Galvanized steel (available in 14 and 16 gauge only)	\$102.00
12 Gauge (See <a href="#">Stick Section</a> )	N/A
Second coat of primer	\$109.00
Finish paint setup charge (N/A Welded)	\$1,350.00
Finish paint (minimum quantity 20 units color)	\$274.00
Welded in prepared opening anchor (per anchor)	\$16.00
Welded in anchor (per anchor)	\$7.00
Punch and dimple only (per prep)	\$5.50
Unit bundle (elevation)	\$19.00
Standard face weld (4pc)	\$232.00
Full profile weld (4pc)	\$416.00

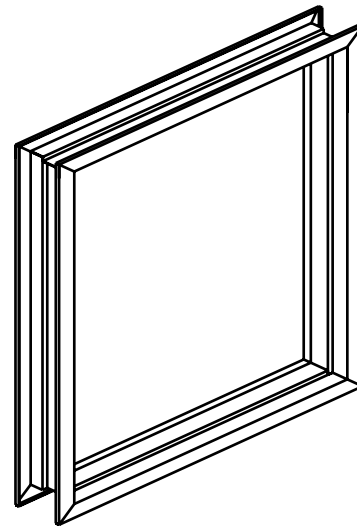

ME Borrowed Lite

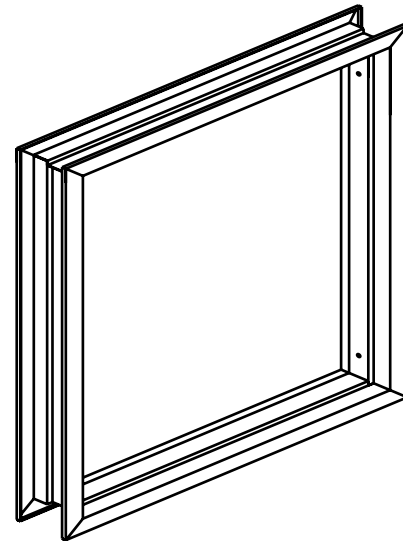

MH Borrowed Lite

See [Engineering Section](#) for further options and/or details.

CUT-N-NOTCH AND PANELS

Sticks

The information contained herein has been prepared to permit architects, engineers and other qualified persons to design and select the proper Republic standard stick components for use in fabricated frame assemblies when subjected to structural or wind loads.

Physical properties and wind load tables were calculated by a registered engineer and are based on the "Specifications for the Design of Cold-Formed Steel Structural Members", 1969 Edition, published by the American Iron and Steel Institute.

Table I (See Technical Data) lists the physical properties of open sections. These sections are usually used as perimeter components in any frame assembly and are not critical components of that assembly because perimeter components must be securely anchored to building walls.

Table II (See Technical Data) lists the physical properties of the closed sections. These sections are usually used as the intermediate horizontal and vertical components and are usually found to be the critical sections in any frame assembly. The critical component in any frame assembly is usually the component having the longest unsupported length or supporting the largest frame area in wind loading.

The most frequently encountered problem is that of designing an intermediate component to resist wind loading only. For this reason, Table III (See Technical Data) is included. This table allows the designer to calculate the wind load on the component in pounds per linear foot and then select the proper section directly from the table.

CUT-N-NOTCH AND WELDED UNIT				
Gauge (14 or 16)	16	<b>EXAMPLE PRICE SHEET -- 4040 BORROWED LITE</b> Overall width and height using Cut-N-Notch May price as BL Components (see page 74), not shown here		
Material (CRS or A60)	CRS			
Jamb depth: (3.00"-20")	5-3/4"			
QTY	Description	List	Total	Page
(in inches)	<b>Cut-N-Notch Stick Material, 2" Face (may use BL in Cut-N-Notch)</b>	<b>Subtotal</b>	\$267.89	
48	4'0" Blank jamb - Open section, top	\$1.40	\$66.97	See page 80
48	4'0" Blank jamb - Open section, bottom	\$1.40	\$66.97	
48	4'0" Blank jamb - Open section, left	\$1.40	\$66.97	
48	4'0" Blank jamb - Open section, right	\$1.40	\$66.97	
(each)	<b>Joints</b>	<b>Subtotal</b>	\$120.00	
8	Mitered corners (per end)	\$15.00	\$120.00	See page 81
(in inches)	<b>Glazing bead</b>	<b>Subtotal</b>	\$147.84	
176	3/4" x 5/8" tall Glazing bead (cut to length, loose)	\$0.65	\$114.40	See page 81
	Installed (taped or screwed in for shipping)	\$0.19	\$33.44	
(each)	<b>Anchors</b>	<b>Subtotal</b>	\$28.00	
4	Welded in (see page 85) Anchor (jamb anchor loose, see page 98)	\$7.00	\$28.00	See page 85
(each)	<b>Welding</b>	<b>Subtotal</b>	\$232.00	
4	Face welding - Tab and slot corner connection	\$58.00	\$232.00	See page 81
<b>Total</b>			\$795.73	

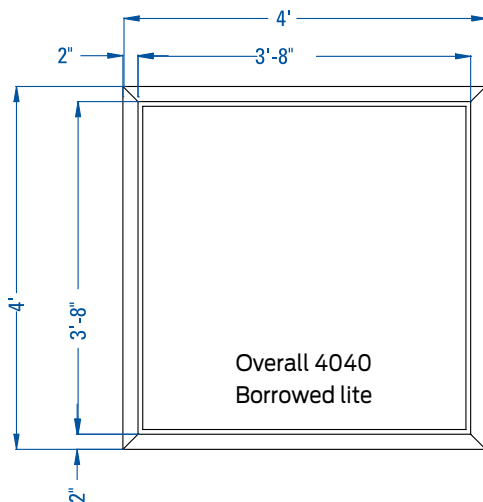

CUT-N-NOTCH AND WELDED UNIT				
Gauge (14 or 16)	14	<b>EXAMPLE PRICE SHEET -- 6440 BORROWED LITE</b> Overall width and height using Cut-N-Notch May price as BL Components (see page 74), not shown here		
Material (CRS or A60)	A60			
Jamb depth: (3.00"-20")	7-3/4"			
QTY	Description	List	Total	Page
(in inches)	<b>Cut-N-Notch Stick Material, 2" Face (may use BL with Cut-N-Notch)</b>	<b>Subtotal</b>	\$716.56	
76	6'4" Blank jamb - Open section, top	\$2.07	\$157.65	See page 80
76	6'4" Blank jamb - Open section, bottom	\$2.07	\$157.65	
48	4'0" Blank jamb - Open section, left	\$2.07	\$99.57	
48	4'0" Blank jamb - Open section, right	\$2.07	\$99.57	
44	3'8" Blank jamb - Mullion section	\$4.59	\$202.11	
(each)	<b>Joints</b>	<b>Subtotal</b>	\$160.00	
8	Mitered corner (per end)	\$15.00	\$120.00	See page 81
2	Notched closed section (per end)	\$20.00	\$40.00	
(in inches)	<b>Glazing bead</b>	<b>Subtotal</b>	\$265.44	
316	3/4" x 5/8" tall Glazing bead (cut to length, loose)	\$0.65	\$205.40	See page 81
	Installed (taped or screwed in for shipping)	\$0.19	\$60.04	
(each)	<b>Anchors</b>	<b>Subtotal</b>	\$28.00	
4	Welded in (see page 85) Anchor (jamb anchor loose, see page 98)	\$7.00	\$28.00	See page 85
(each)	<b>Welding</b>	<b>Subtotal</b>	\$412.00	
4	Face welding - Tab and slot corner connection	\$58.00	\$232.00	See page 81
2	Face welding - 2" or less (at mullion notches)	\$90.00	\$180.00	
<b>Total</b>			\$1,582.00	

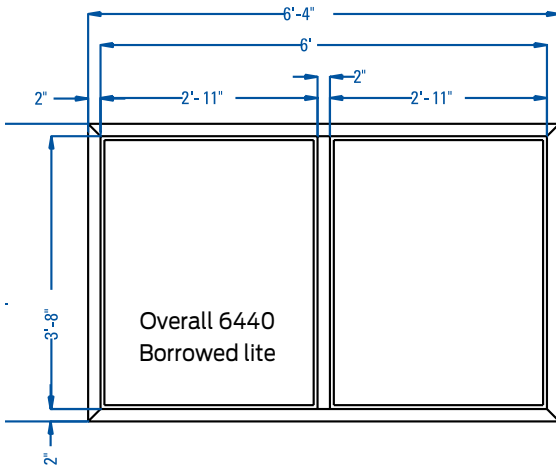

SE SERIES

BORROWED LITES

CUT-N-NOTCH AND PANELS

CUT-N-NOTCH AND WELDED UNIT				
Gauge (14 or 16)	16	<b>EXAMPLE PRICE SHEET -- 5672 ELEV WITH PARTIAL SIDE LITE</b> Overall width and height using Cut-N-Notch (May be priced as ME with sticks, not shown here)		
Material (CRS or A60)	CRS			
Jamb depth: (3.00"-20")	7-3/4"			
QTY	Description	List	Total	Page
(in inches)	<b>Cut-N-Notch Stick Material, 2" Face (may use ME with Cut-N-Notch)</b>	<b>Subtotal</b>	\$621.65	
86	7'2" Blank jamb - Open section, left	\$1.52	\$130.61	See page 80
66	5'6" Blank jamb - Open section, head	\$1.52	\$100.24	
36	3'0" Blank jamb - Open, right	\$1.52	\$54.68	
26	2'2" Blank jamb - Open, bottom	\$1.52	\$39.49	
84	7'0" Blank mullion - Closed section (see Cut open back)	\$3.53	\$296.64	
(each)	<b>Joints</b>	<b>Subtotal</b>	\$130.00	
6	Mitered corner (per end)	\$15.00	\$90.00	See page 81
2	Notched closed section (per end)	\$20.00	\$40.00	
(each)	<b>Hardware preps</b>	<b>Subtotal</b>	\$176.00	
1	ASA 4-7/8" Strike prep	\$23.00	\$23.00	See page 81
3	4-1/2" x 4-1/2" Hinge prep (per hinge)	\$23.00	\$69.00	
1	Cut Open Back/weld in sill anchor (for closed sect)	\$84.00	\$84.00	
(in inches)	<b>Glazing bead</b>	<b>Subtotal</b>	\$94.08	
112	3/4" x 5/8" tall Glazing bead (cut to length, loose)	\$0.65	\$72.80	See page 81
	Installed (taped or screwed in for shipping)	\$0.19	\$21.28	-
(each)	<b>Anchors</b>	<b>Subtotal</b>	\$55.50	
7	Welded in (see page 85) Anchor (jamb anchor loose, see page 98)	\$7.00	\$49.00	See page 85
2	One piece sill anchor (loose base anchor)	\$3.25	\$6.50	
(each)	<b>Welding</b>	<b>Subtotal</b>	\$354.00	
3	Face welding - Tab and slot corner connection	\$58.00	\$174.00	See page 81
2	Face welding - 2" or less (at mullion notches)	\$90.00	\$180.00	
<b>Total</b>			\$1,431.23	

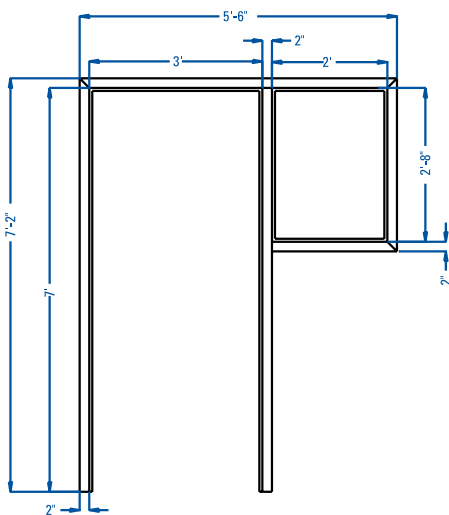

Overall 5672 Elevation with Partial side light

CUT-N-NOTCH AND WELDED UNIT				
Gauge (14 or 16)	16	<b>EXAMPLE PRICE SHEET -- 5674 ELEVATION WITH SIDE LITE</b> Overall width and height using Cut-N-Notch (May be priced as ME with sticks, not shown here)		
Material (CRS or A60)	A60			
Jamb depth: (3.00"-20")	8-3/4"			
QTY	Description	List	Total	Page
(in inches)	<b>Cut-N-Notch Stick Material, 2" Face (may use ME with Cut-N-Notch)</b>	<b>Subtotal</b>	\$1,064.71	
86	7'2" Blank jamb - Open section, left	\$2.10	\$180.52	See page 80
86	7'2" Blank jamb - Open section, right	\$2.10	\$180.52	
84	7'0" Blank mullion - Closed section, vertical	\$4.21	\$353.69	
24	7'0" Blank mullion - Closed section, horizontal	\$4.21	\$101.05	
66	5'6" Blank jamb - Open section, 4" face head	\$2.77	\$182.55	
24	2'0" Blank jamb - Open section, 4" face sill	\$2.77	\$66.38	
(each)	<b>Joints</b>	<b>Subtotal</b>	\$150.00	
4	Mitered corner (per end)	\$15.00	\$60.00	See page 81
2	Notched open section (per end)	\$15.00	\$30.00	
3	Notched closed section (per end)	\$20.00	\$60.00	
(each)	<b>Hardware preps</b>	<b>Subtotal</b>	\$92.00	
1	ASA 4-7/8" Strike prep	\$23.00	\$23.00	See page 81
3	4-1/2" x 4-1/2" Hinge prep (per hinge)	\$23.00	\$69.00	
(in inches)	<b>Glazing bead</b>	<b>Subtotal</b>	\$211.68	
252	3/4" x 5/8" tall Glazing bead (cut to length, loose)	\$0.65	\$163.80	See page 81
	Installed (taped or screwed in for shipping)	\$0.19	\$47.88	
(each)	<b>Anchors</b>	<b>Subtotal</b>	\$61.10	
6	Welded in (see page 85) Anchor (jamb anchor loose, see page 98)	\$7.00	\$42.00	See page 81
2	One piece sill anchor (loose base anchor)	\$3.25	\$6.50	See page 98
1	Base anchor for sticks (loose)	\$12.60	\$12.60	See page 98
(each)	<b>Welding</b>	<b>Subtotal</b>	\$602.00	
2	Face welding - Tab and slot corner connection	\$58.00	\$116.00	See page 81
3	Face welding - 2" or less (at mullion notches)	\$90.00	\$270.00	
2	Face welding - Over 2" up to 4" (at sill notches)	\$108.00	\$216.00	
<b>Total</b>			\$2,181.49	

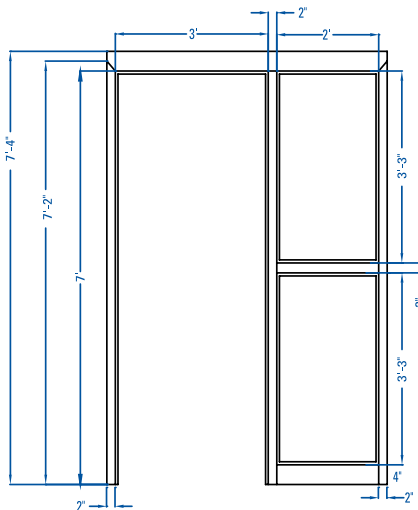

Overall 5674 Elevation with Side light

SE SERIES

BORROWED LITES

CUT-N-NOTCH AND PANELS

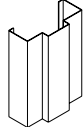
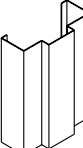
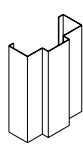
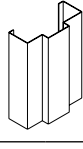
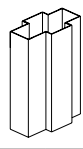
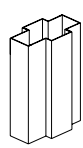
CUT-N-NOTCH/PER INCH					
Components	Jamb depth	16 Gauge		14 Gauge	
		CRS	A60	CRS	A60
Blank Jamb 2" Face 	4-5/8" – 5-7/8"	\$1.40	\$1.65	\$1.64	\$1.93
	6" – 7-7/8"	\$1.52	\$1.68	\$1.89	\$2.07
	8" – 9-7/8"	\$1.93	\$2.10	\$2.40	\$2.59
	10" – 11-7/8"	\$2.30	\$2.58	\$2.70	\$2.89
	12" – 14-3/4"	\$2.79	\$3.07	\$3.33	\$3.58
	14-7/8" – 20"	\$3.49	\$3.84	\$4.17	\$4.48
BJ/1"–4" Face 	4-5/8" – 5-7/8"	\$1.86	\$2.09	\$2.17	\$2.43
	6" – 7-7/8"	\$2.03	\$2.20	\$2.36	\$2.58
	8" – 9-7/8"	\$2.57	\$2.77	\$3.04	\$3.21
	10" – 11-7/8"	\$3.01	\$3.22	\$3.40	\$3.58
	12" – 14-3/4"	\$3.67	\$3.85	\$4.28	\$4.47
	14-7/8" – 20"	\$4.58	\$4.82	\$5.36	\$5.59
BJ/4-1/8"–8-1/8" Face 	4-5/8" – 5-7/8"	\$3.26	\$3.69	\$4.04	\$4.38
	6" – 7-7/8"	\$4.07	\$4.46	\$4.81	\$5.27
	8" – 9-7/8"	\$4.40	\$4.80	\$5.48	\$5.92
	10" – 11-7/8"	\$4.67	\$5.13	\$5.75	\$6.32
	12" – 14-3/4"	\$5.17	\$5.68	\$6.43	\$6.99
	14-7/8" – 20"	\$6.60	\$7.10	\$8.25	\$8.74
BJ/8-1/4"–12" Face 	4-5/8" – 5-7/8"	\$3.85	\$4.19	\$4.51	\$4.97
	6" – 7-7/8"	\$4.56	\$4.84	\$5.11	\$5.60
	8" – 9-7/8"	\$4.87	\$5.11	\$5.69	\$6.21
	10" – 11-7/8"	\$5.53	\$5.79	\$6.25	\$6.77
	12" – 14-3/4"	\$6.37	\$6.43	\$7.74	\$8.48
	14-7/8" – 20"	\$7.96	\$8.04	\$9.72	\$10.60
Blank Mullion 2" Face 	4-5/8" – 5-7/8"	\$3.10	\$3.43	\$3.58	\$3.86
	6" – 7-7/8"	\$3.53	\$3.90	\$4.36	\$4.59
	8" – 9-7/8"	\$3.93	\$4.21	\$4.75	\$4.99
	10" – 11-7/8"	\$4.58	\$5.11	\$5.40	\$5.70
	12" – 14-3/4"	\$5.49	\$6.01	\$6.41	\$6.70
	14-7/8" – 20"	\$6.87	\$7.52	\$8.01	\$8.38
Blank Mullion 2-1/8"–4" 	4-5/8" – 5-7/8"	\$4.01	\$4.32	\$4.59	\$4.86
	6" – 7-7/8"	\$4.64	\$4.83	\$5.53	\$5.64
	8" – 9-7/8"	\$5.16	\$5.21	\$6.00	\$6.22
	10" – 11-7/8"	\$5.99	\$6.36	\$6.93	\$7.17
	12" – 14-3/4"	\$6.84	\$7.43	\$7.96	\$8.64
	14-7/8" – 20"	\$8.55	\$9.29	\$9.96	\$10.80

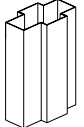
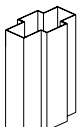
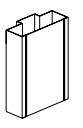
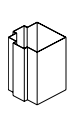
CUT-N-NOTCH/PER INCH					
Components	Jamb depth	16 Gauge		14 Gauge	
		CRS	A60	CRS	A60
Blank Mullion 4-1/8"–8-1/8" 	4-5/8" – 5-7/8"	\$5.14	\$5.37	\$5.82	\$6.09
	6" – 7-7/8"	\$5.83	\$6.04	\$6.43	\$6.74
	8" – 9-7/8"	\$6.32	\$6.51	\$7.11	\$7.38
	10" – 11-7/8"	\$7.17	\$7.95	\$7.98	\$8.20
	12" – 14-3/4"	\$8.56	\$9.00	\$9.68	\$10.22
	14-7/8" – 20"	\$10.70	\$11.25	\$12.10	\$12.78
Blank Mullion 8-1/4"–12" 	4-5/8" – 5-7/8"	\$5.51	\$5.75	\$5.98	\$6.35
	6" – 7-7/8"	\$6.24	\$6.46	\$6.93	\$7.21
	8" – 9-7/8"	\$6.77	\$6.96	\$7.61	\$7.85
	10" – 11-7/8"	\$7.68	\$8.51	\$8.14	\$8.32
	12" – 14-3/4"	\$9.15	\$9.63	\$10.19	\$10.37
	14-7/8" – 20"	\$11.44	\$12.04	\$12.73	\$12.97
Filler Section 	4-5/8" – 5-7/8"	\$1.56	\$1.74	\$1.80	\$2.04
	6" – 7-7/8"	\$1.72	\$1.90	\$1.93	\$2.15
	8" – 9-7/8"	\$1.82	\$2.00	\$2.04	\$2.27
	10" – 11-7/8"	\$2.01	\$2.19	\$2.40	\$2.63
	12" – 14-3/4"	\$2.44	\$2.63	\$3.01	\$3.24
	14-7/8" – 20"	\$3.06	\$3.29	\$3.77	\$4.04
Corner Posts 2/3 Way 	4-5/8" – 5-7/8"	\$5.88	\$6.17	\$6.40	\$6.64
	6" – 7-7/8"	\$6.21	\$6.46	\$6.87	\$7.10
	8" – 9-7/8"	\$6.48	\$6.79	\$7.66	\$8.03
	10" – 11-7/8"	\$7.56	\$7.87	\$8.56	\$8.89
	12" – 14-3/4"	\$8.95	\$9.15	\$10.05	\$10.31
	14-7/8" – 20"	\$11.19	\$11.44	\$12.56	\$12.89

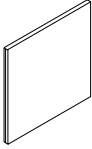

PANELS				
 <p>Maximum size 4'0" x 4'0" (When either dimension exceeds 48" price as door)</p>	<b>Non-label panels</b>			
	20 Gauge base price	\$355.00	add per sq. ft.	\$35.00
	18 Gauge base price	\$355.00	add per sq. ft.	\$45.00
	16 Gauge base price	\$355.00	add per sq. ft.	\$47.00
	14 Gauge base price	\$355.00	add per sq. ft.	\$58.00
	<b>Label panels</b>			
	20 Gauge base price	\$443.00	add per sq. ft.	\$35.00
	18 Gauge base price	\$443.00	add per sq. ft.	\$45.00
	16 Gauge base price	\$443.00	add per sq. ft.	\$47.00
	14 Gauge base price	\$443.00	add per sq. ft.	\$63.00
	<b>Options</b>			
	A60 Galvanized steel			\$105.00
	G90 Galvanized steel (14 and 16 gauge only)			\$419.00
	Flat bar astragal attached to bottom of panel			\$110.00
Polystyrene core			\$39.00	
Flush bolt strike			\$95.00	

FRAME PROFILE OPTIONS/PER INCH	
No returns	No charge
Cased open	No charge
Single rabbet	No charge
Non-standard rabbet	\$0.45
Kerf (includes weather-stripping) (16 gauge only)	\$0.67
Non-standard returns (uniform)	\$0.72
Weld in filler	\$2.59

STEEL TYPES/PER INCH	
Cold rolled steel and A60 Galvanized steel	Included
G90 Galvanized steel - Stick <sup>1</sup>	\$0.32
G90 Galvanized steel - Mullion <sup>1</sup>	\$0.32
12 Gauge - Jamb/Stick <sup>2</sup>	\$4.13

1. Available in 14 and 16 gauge only.
2. Not available on mullions/add to 14 gauge.

HINGE PREPARATIONS	
Special hinge locations	No charge
4.5" x 4.5" Hinge prep (per hinge)	\$23.00
5" Universal hinge prep (per hinge)	\$23.00

FRAME - STRIKE PREPARATIONS	
Special strike location	No charge
ANSI 4-7/8" ASA strike	\$23.00
Cylindrical dead lock (2-3/4" strike)	\$23.00
Mortise dead lock (3-1/2" strike)	\$23.00
Cut open backside of mullion/weld in sill anchor	\$84.00

See [Engineering Section](#) for further options and/or details.

NOTCHING/WELDING	
Mitered corner - Jamb (per end) (N/A in 12 gauge)	\$15.00
Notched end - Jamb/Sill (per end)	\$15.00
Notched end - Mullion (per end)	\$20.00
Glazing bead 3/4" wide - cut to length/bundled (per inch)	\$0.65
Glazing bead 1/2" wide - cut to length/bundled (per inch)	\$0.96
Glazing bead - installed (add to above) (per inch)	\$0.19
Full profile welding - Tab and slot corner connection	\$108.00
Face welding - Tab and slot corner connection	\$58.00
Face welding - 2" or less intersection	\$90.00
Face welding - over 2" up to 4" intersection	\$108.00
Face welding - over 4" up to 6" intersection	\$136.00
Face welding - over 6" up to 8" intersection	\$163.00
Face welding - over 8" up to 10" intersection	\$163.00
Face welding - over 10" up to 12" intersection	\$163.00
Field splicing - per connection (clips sold separately)	\$109.00
Splice/weld over 10' length	\$145.00

SPECIALTY OPTIONS/PER INCH	
1/16" Lead Installed, open section frames only	\$21.74
Bullet resistant (Level 1)	\$1.03

### ENGINEERING

STEEL TYPES		
Description	Door	Frame
Cold rolled steel	Included	Included
A60 Galvanized steel	\$105.00	\$56.00
G90 Galvanized steel <sup>1</sup>	\$419.00	\$102.00
12 Gauge <sup>2</sup>	N/A	N/A

- Available in 14 and 16 gauge only.
- See [Stick Section](#) for frames. Frames must be square cut or Cut-N-Notch connection(s). Welding required (not included) \*5/8" returns

CORE OPTIONS		
Description	Door	Frame
Honeycomb	Included	N/A
Polystyrene insulated <ul style="list-style-type: none"> <li>▪ "U" Factor = .41</li> <li>▪ "R" Factor = 2.43 (Per ASTM C1363)</li> </ul>	\$39.00	N/A
Polyurethane insulated <ul style="list-style-type: none"> <li>▪ "U" Factor = .39</li> <li>▪ "R" Factor = 2.56 - (Per ASTM C1363)<sup>3</sup></li> </ul>	\$194.00	N/A
Steel stiffened (20 gauge standard) <ul style="list-style-type: none"> <li>▪ "U" Factor = .61</li> <li>▪ "R" Factor = 1.65 (Per ASTM C1363)</li> </ul>	\$301.00	N/A
Steel stiffened (18 gauge option)	\$375.00	N/A
Steel stiffened (16 gauge option)	\$526.00	N/A
Steel stiffened with 20 gauge stiffeners and Polystyrene insulation between stiffeners	\$352.00	N/A
Temperature rise 250°, to insulated DL/DE price	\$1,005.00	N/A

- Not available as Fire rated.

PIVOT OPTIONS		
Description	Door	Frame
Offset or intermediate - per prep <sup>4</sup>	\$354.00	\$108.00
Center hung - per prep <sup>4</sup>	N/A	\$108.00
Rescue hardware prep - one pivot prep and emergency stop <sup>4</sup>	N/A	\$287.00
Double lipped strike - per prep	N/A	\$144.00
Pocket pivot - per prep <sup>5</sup>	\$194.00	\$163.00

- No drilling or tapping.
- No drilling or tapping in door.

HINGE PREPARATIONS		
Description	Door	Frame
Special hinge locations	No charge	No charge
4-1/2" Universal hinge prep (1) prep for every 30" in height	No charge	No charge
Additional hinge prep (per hinge)	\$25.00	\$23.00
4" Template hinge prep (square corner only) (per hinge)	\$58.00	\$58.00
5" Universal weight hinge prep (per hinge)	No charge	No charge
Non-standard height 6"-8" hinge (per hinge)	\$101.00	\$75.00
Double mortise hinge (per hinge)	\$53.00	N/A
Invisible hinge prep (SOSS) (per hinge) (includes drilling and tapping)	\$272.00	\$272.00
Anchor hinge prep (per hinge) (no drilling or tapping)	\$488.00	\$287.00
Electric hinge <ul style="list-style-type: none"> <li>▪ No junction box or conduit, no wiring included</li> <li>▪ One 1/2" dia. hole in one hinge reinf.</li> </ul>	\$25.00	\$22.00
Surface mounted hinges (reinforcement only)	\$114.00	N/A
Continuous hinge reinforcement <ul style="list-style-type: none"> <li>▪ Frame, located either on rabbet or face</li> <li>▪ Door, located on either hinge edge or approx 4" on face of hinge side</li> </ul>	\$88.00	\$83.00
High frequency hinge reinforcement (per hinge) (typical top hinge only)	N/A	\$26.00
Double acting hinge reinforcement (Eliason) 12 gauge - 24" up x JD @ bottom/12" down x JD @ top (per jamb)	N/A	\$110.00
Double acting hinge reinforcement 12 gauge - 12" x JD (per location)	N/A	\$58.00
Full jamb height hinge reinforcement 12 gauge - 2" x Hgt.	N/A	\$85.00
Power transfer <ul style="list-style-type: none"> <li>▪ No junction box or conduit</li> <li>▪ Cutout with reinforcement/tap plate(s)</li> </ul>	\$131.00	\$104.00
Special backset (per hinge)	\$131.00	\$74.00
Handed hinge prep	\$21.00	N/A

STRIKE/LOCK PREPARATIONS		
Description	Door	Frame
Special strike or lock location	No charge	No charge
ANSI 4-7/8" Strike prep	\$59.00	\$23.00
Mortise lock prep - Gov't 86 edge with function holes	\$56.00	N/A
Mortise lock prep for 1-3/8" thick door	\$71.00	N/A
Cylindrical dead lock prep ▪ Frame: 2-3/4" or 4-7/8" strike (lipped or non-lipped) ▪ Door: Gov't 160 or 161 prep	\$61.00	\$23.00
Mortise dead lock prep ▪ Frame: 3-1/2" or 4-7/8" strike (lipped or non-lipped) ▪ Door: Gov't 86 mortise lock prep	\$61.00	\$23.00
Card reader lock prep (ex. Vingcard)	\$53.00	N/A
Special backset (over 5")	\$49.00	N/A
Rim reinforcement only	\$50.00	\$30.00
Rim reinforcement with function prep	\$56.00	N/A
Mortise exit device reinforcement only	\$37.00	N/A
Mortise exit device reinforcement with function prep	\$89.00	N/A
Allegion Mortise exit device reinforcement with function prep	\$71.00	N/A
Surface vertical rod reinforcement only	\$82.00	\$30.00
Surface vertical rod reinforcement with function prep	\$99.00	N/A
Allegion Surface vertical rod reinforcement with function prep	\$87.00	N/A
Concealed vertical rod ▪ Frame mortise strike (per prep) ▪ Door per template	\$611.00	\$69.00
Allegion Concealed vertical rod ▪ Frame mortise strike (per prep) ▪ Door per template	\$476.00	N/A
Exit alarm reinforcement only	\$62.00	\$29.00
Inset exit device (14 and 16 gauge doors only)/ Frame Non ASA strike	\$476.00	N/A
Push pull reinforcement	\$40.00	N/A
Electric strike mortise prep (no junction box or conduit)	\$135.00	\$68.00
Flush bolt ▪ Strike prep Frame, reversible or automatic ▪ Door - Edge, top and bottom prep - ANSI A115.4	\$95.00	\$59.00
Surface bolt reinforce only	\$36.00	\$30.00
Detention/security lock (ex. FA NS400/Brinks 3526)	\$153.00	\$143.00
Non-standard gauge/special thickness strike reinforcement (standard prep)	N/A	\$67.00
Flush cup pull prep (per side)	\$129.00	N/A
Roller latch (per prep top or lock edge)	\$88.00	\$44.00
Fire bolt/popper (each prep)	\$44.00	N/A

CLOSER PREPARATIONS		
Description	Door	Frame
Closer reinforcement ▪ Frame 14 gauge x 14" Plate - RA or PA ▪ Door 14 gauge x 18" x 6"	\$37.00	\$29.00
Door - optional 12 gauge reinforcement	\$71.00	N/A
Door - full width reinforcement (price per 18")	\$37.00	N/A
Frame - full depth reinforcement (price per foot)	N/A	\$32.00
Coordinator reinforcement	N/A	\$29.00
Concealed overhead door closer, holder, or stop	\$371.00	\$289.00
Allegion Concealed overhead door closer, holder, or stop	\$323.00	\$262.00
Surface mounted overhead stop/holder reinforcement	N/A	\$87.00

INACTIVE LEAF PREPARATIONS		
Description	Door	Frame
Flush bolt embossment in top/bottom channel	No charge	N/A
ANSI (4-7/8") Strike only	\$59.00	N/A
Cylindrical (2-3/4") or mortise (3-1/2") dead lock strike	\$61.00	N/A
Attaching astragal (includes astragal)	\$110.00	N/A
Open back strike	\$161.00	N/A

LABEL PREPARATIONS		
Description	Door	Frame
Mark numbers	No charge	No charge
U.L. Mylar label <sup>1</sup>	\$20.00	\$22.00
U.L. Metal label	\$48.00	\$29.00
ITS/Warnock Hersey Metal label	\$48.00	\$29.00
Hurricane FBC or E330 label	\$20.00	\$22.00

1. Standard unless specified otherwise.

GENERAL

DOORS

FRAMES

SPECIALTY

STICKS

ENGINEERING

VALU-PAC

DOOR PARTS

FRAME PARTS

HARDWARE

SPECIAL CONSTRUCTIONS		
Description	Door	Frame
Special width (use next larger size) (max 4'10" on doors)	No charge	No charge
Special height (use next larger size) (max 10'0" on doors)	No charge	No charge
Undercut - under 3/8" price next larger size	No charge	N/A
Inverted top channel (standard flush)	No charge	N/A
Flush bottom channel (standard inverted)	No charge	N/A
Seal top or bottom channel and finish smooth (per each)	\$142.00	N/A
Bondo filled edge (includes both hinge and lock edge)	\$115.00	N/A
Continuous welded edge (includes hinge and lock edge) <sup>1</sup>	\$169.00	N/A
Unifit channel - consult factory for availability	\$89.00	N/A
Communicating (6) 4.5" hinge preps x (2) 4-7/8" ASA preps, or (2) 2-3/4" strike preps	N/A	\$83.00
Dutch prep (4) 4.5" hinge preps x (1) ASA preps <sup>2</sup>	\$92.00	\$85.00
Cap top of jamb (each)	N/A	\$139.00
Mag switch/DPS - Hole only	\$23.00	\$22.00
Mag switch/DPS - Prep and reinf. (no junction box)	\$123.00	\$90.00
Magnetic/shear lock - mortised prep in top of door	\$323.00	\$207.00
Hospital stop (galv) up to 6" (N/A on double egress)	N/A	\$222.00
8" Junction box welded in	N/A	\$33.00
14" Junction box welded in	N/A	\$33.00
10" Junction box welded in soffit	N/A	\$33.00
Removeable HM mullion prep - notch (1) end of piece, weld in angle clip(s)	N/A	\$84.00
Removeable HM mullion reinforcement only	N/A	\$23.00
removeable hardware mullion reinforcement only	N/A	\$23.00
Beveled lock edge (1/8" in 2") <sup>3</sup>	\$23.00	N/A
10 Gauge hinge and 14 gauge lock channels DE Series (standard on 14 gauge door)	\$156.00	N/A
1-3/8" Thick door - DE Series - Polystyrene core only (no DE price adder required) <sup>4,5</sup>	\$156.00	N/A
Non-standard rabbet 2" thick door	N/A	\$246.00
14 GA Top or bottom channel (per each)	\$74.00	N/A
Rabbeted door or panel (per edge)	\$751.00	N/A
Wicket door prep (consult factory)	Inquiry**	N/A
Door viewer	\$30.00	N/A
Mail slot/food service pass thru (up to 100 sq. In.) - Cutout only	\$85.00	N/A
Monorail prep (per leaf)	\$459.00	N/A
Automatic door bottom (mortise type)	\$225.00	N/A
Conduit/raceway installed in door - Includes wire pull (N/A in DP and no wire pull in DF)	\$190.00	N/A

**\*\*Email Estimating requests for quote prior to order submission.**

**Note:**  
 Please include Job Name.  
 Product is produced off-site and ships separately.  
 Email: [republic.esteeming@allegion.com](mailto:republic.esteeming@allegion.com)

1. Not available in 20 gauge.
2. Refer to inactive options for ASA in either top or bottom leaf.
3. Not available in 14 gauge and Inactive leaves with strike(s).
4. 6'8" door - standard (2) 3.5" hinges, (1) CH lock prep (2-1/8" Bore x 2-3/4" Backset/1" x 2-1/4" Edge)
5. Fire Rated 6'8" requires (3) hinge preps - ADD (1) hinge prep.

SPECIAL FINISH PREPARATIONS		
Description	Door	Frame
Second coat of Republic primer	\$124.00	\$109.00
Finish paint setup charge (never waived)	\$1,350.00	\$1,350.00
Finish paint - min. qty. 20 doors or 3pc frames per color (price includes full carton wrap)	\$274.00	\$274.00

Finish paint not available with welded frames.

ANCHOR OPTIONS		Price adjustment	
Description	Door	Frame	
Welded in prepared opening anchor - Punch and dimple with anchor (per anchor)	N/A	\$16.00	
Welded in anchor (per anchor)	N/A	\$7.00	
Punch and dimple only (per prep)	N/A	\$5.50	
Deduct for omit drywall compression anchor (Per frame)	N/A	-\$6.00	
Embossed hole - 3/16" in face for (#10 bugle head screw) approx 3/4" from bottom	N/A	No charge	
3/8" x 5" Sleeve anchor (each) (sold separately)	N/A	\$8.00	

For loose anchors, refer to [Frame Parts](#).

Frames up to 7'0 quantity of anchors - 6 (max 8-3/4" depth).

Frames over 7'0 thru 10'0 quantity of anchors - 8 (max 8-3/4" depth).

Frames over 8-3/4" depth receive double anchor quantity.

FRAME CONSTRUCTION		
Description	Door	Frame
Mark numbers	No charge	No charge
Unit bundle (3pc)	N/A	\$7.00
Unit bundle (Elevation)	N/A	\$19.00
Standard face weld (3pc)	N/A	\$116.00
Full profile weld (3pc)	N/A	\$208.00

FRAME PROFILE OPTIONS		
Description	Door	Frame
No returns	N/A	No charge
Equal rabbet - standard unequal rabbet	N/A	No charge
Cased open	N/A	No charge
Single rabbet	N/A	No charge
4" Face heads (through 4'0")	N/A	\$59.00
4" Face heads (over 4'0")	N/A	\$83.00
Non standard face - per frame (1" - 3-7/8" Uniform)	N/A	\$65.00
Non standard rabbet - per frame	N/A	\$246.00
Drywall (second) return (1/2") (both sides)	N/A	\$65.00
Kerf (includes weather-stripping)	N/A	\$183.00
Non standard returns (uniform)	N/A	\$65.00
Nailer flange (per frame/both faces)	N/A	\$134.00
Casement ready (MN Series - nailer holes) (per frame)	N/A	\$78.00

GLASS KIT OPTIONS			
	Vision/ Narrow Lite up to 100 inch <sup>2</sup>	Half Glass over 100 inch <sup>2</sup> up to 800 inch <sup>2</sup>	Full Glass over 800 inch <sup>2</sup>
Cutout with kit installed	\$231	\$274	N/A
Cutout with kit and reinforcement	\$313	\$356	\$389
Sunburst kit (cutout and 1/2" glass included)	\$560	N/A	N/A
Muntin bar (each)	\$150	\$150	\$150
Galvanized kit add	\$127	\$127	\$127
Glass pocket add (other than 1/4")	\$209	\$209	\$209
Hurricane approved light kits - Air louvers VLFIGHRC or VLFEZHRC (Add to Cutout price above)	\$1,644	\$2,979	\$2,979

Note: Prices are based on Republic standard lite kit (No glass unless noted otherwise). For Bullet Resistant Options, see [Specialty Section](#).

CUTOUT ONLY OPTIONS (GLASS KITS AND LOUVERS)			
	Up to 100 inch <sup>2</sup>	Over 100 inch <sup>2</sup> up to 800 inch <sup>2</sup>	Over 800 inch <sup>2</sup>
Panel in place	\$85	\$85	N/A
Cutout only	\$85	\$85	N/A
Cutout with reinforcement	\$167	\$167	\$167
Round cutout only (no reinf)	\$325	\$325	N/A

LOUVER OPTIONS		
Description	Size	Price
Louver installed no reinf	12" x 12"	\$400.00
Louver installed no reinf	18" x 12"	\$453.00
Louver installed no reinf	24" x 12"	\$535.00
Louver installed no reinf	24" x 18"	\$603.00
Louver installed no reinf	24" x 24"	\$734.00
Louver installed no reinf	24" x 60"	\$1,524.00
Special size louvers	Consult Factory	
Galvanized louver add	-	\$54.00
Fusible link louver add	-	\$402.00
Insect screen add	Consult Factory	
Louver insert - Air louvers 1500	-	\$3,466.00

Note: Prices are based on Republic standard louver.

SPECIAL PACKAGING		
Description	Door	Frame
Generic door carton (each full carton) packaged over standard carton	\$58.00	N/A
Crating - special materials, sizes, etc.	Consult Factory	

GENERAL  
DOORS  
FRAMES  
SPECIALTY  
STICKS  
ENGINEERING  
VALU-PAC  
DOOR PARTS  
FRAME PARTS  
HARDWARE

## VALU-PAC

GENERAL  
DOORS  
FRAMES  
SPECIALTY  
STICKS  
ENGINEERING  
VALU-PAC  
DOOR PARTS  
FRAME PARTS  
HARDWARE

DP VALU-PAC DOORS - 418			
418 CRS/HC CR			
Description	Qty	Weight	20
3068 F CH CR	20	1900	\$12,402
3068 F MOL CR	20	1900	\$12,402
3070 F CH CR	20	1980	\$12,751
3070 F MOL CR	20	1980	\$12,751
3070 F DT CR	20	1980	\$12,751
3070 F OL CR	20	1980	\$12,751
3670 F CH CR	20	2320	\$14,867
4070 F CH CR	20	2640	\$16,026

418 CRS/HC NO CR			
Description	Qty	Weight	20
3068 F CH	20	1740	\$11,721
3070 F CH	20	1820	\$12,070

418 CRS/INSUL (STY) CR			
Description	Qty	Weight	20
3068 F CH CR INS*	20	1960	\$13,119
3070 F CH CR INS*	20	2120	\$13,469
3070 F MOL CR INS*	20	2120	\$13,469

418 CRS/INSUL (STY) NO CR			
Description	Qty	Weight	20
3068 F CH INS*	20	1800	\$12,438
3070 F CH INS*	20	1960	\$12,788
3070 F MOL INS*	20	1960	\$12,788

1. Discounts apply only to whole Valu-Pac Units of (20).
2. Broken pallets quantities will be at full list price.
3. Valu-Pac discount pricing not eligible for any other additional pricing discounts.
4. For consideration of additional size or product options, please contact the factory.
5. Standard 90 minute mylar label.

DP VALU-PAC DOORS - 420			
420 CRS/HC CR			
Description	Qty	Weight	20
3068 F CH CR	20	1600	\$11,003
3070 F CH CR	20	1640	\$11,426

420 CRS/HC NO CR			
Description	Qty	Weight	20
3068 F CH	20	1440	\$10,322
3070 F CH	20	1500	\$10,746

420 CRS/INSUL (STY) CR			
Description	Qty	Weight	20
3068 F CH CR INS	20	1660	\$11,721
3070 F CH CR INS	20	1720	\$12,144

420 CRS/INSUL (STY) NO CR			
Description	Qty	Weight	20
3068 F CH INS	20	1500	\$11,040
3070 F CH INS	20	1560	\$11,463

1. Discounts apply only to whole Valu-Pac Units of (20).
2. Broken pallets quantities will be at full list price.
3. Valu-Pac discount pricing not eligible for any other additional pricing discounts.
4. For consideration of additional size or product options, please contact the factory.
5. Standard 90 minute mylar label.

DP VALU-PAC DOORS - 418 - GALVANIZED			
418 GALV/HC - CR			
Description	Qty	Weight	20
3068 F CH CR GLV	20	1900	\$14,334
3068 F MOL CR GLV	20	1900	\$14,334
3070 F CH CR GLV	20	1980	\$14,683
3070 F MOL CR GLV	20	1980	\$14,683
3070 F DT CR GLV	20	1980	\$14,683
3070 F OL CR GLV	20	1980	\$14,683
3670 F CH CR GLV	20	2320	\$16,799
4070 F CH CR GLV	20	2640	\$17,958

418 GALV/HC - NO CR			
Description	Qty	Weight	20
3068 F CH GLV	20	1740	\$13,653
3070 F CH GLV	20	1820	\$14,002

418 GALV/INSUL (STY) - CR			
Description	Qty	Weight	20
3068 F CH CR GLV INS*	20	1960	\$15,051
3070 F CH CR GLV INS*	20	2120	\$15,401
3070 F MOL CR GLV INS*	20	2120	\$15,401

418 GALV/INSUL (STY) - NO CR			
Description	Qty	Weight	20
3068 F CH GLV INS*	20	1800	\$14,370
3070 F CH GLV INS*	20	1960	\$14,720
3070 F MOL GLV INS*	20	1960	\$14,720

1. Discounts apply only to wholeValu-Pac Units of (20).
2. Broken pallets quantities will be at full list price.
3. Valu-Pac discount pricing not eligible for any other additional pricing discounts.
4. For consideration of additional size or product options, please contact the factory.
5. Fire-Rated to 3 Hours UL and ITS Limited.

DP VALU-PAC DOORS - 420 - GALVANIZED			
420 GALV/HC - CR			
Description	Qty	Weight	20
3068 F CH CR GLV	20	1600	\$12,935
3070 F CH CR GLV	20	1640	\$13,358

420 GALV/HC - NO CR			
Description	Qty	Weight	20
3068 F CH GLV	20	1440	\$12,254
3070 F CH GLV	20	1500	\$12,678

420 GALV/INSUL (STY) - CR			
Description	Qty	Weight	20
3068 F CH CR GLV INS	20	1660	\$13,653
3070 F CH CR LGLV INS	20	1720	\$14,076

420 GALV/INSUL (STY) - NO CR			
Description	Qty	Weight	20
3068 F CH GLV INS	20	1500	\$12,972
3070 F CH GLV INS	20	1560	\$13,395

1. Discounts apply only to whole Valu-Pac Units of (20).
2. Broken pallets quantities will be at full list price.
3. Valu-Pac discount pricing not eligible for any other additional pricing discounts.
4. For consideration of additional size or product options, please contact the factory.
5. Fire-Rated to 3 Hours UL and ITS Limited.

GENERAL

DOORS

FRAMES

SPECIALTY

STICKS

ENGINEERING

VALU-PAC

DOOR PARTS

FRAME PARTS

HARDWARE

UNIVERSAL FRAME COMPONENTS							
Discounting Applies to the Total Number of Frame ValuPac Units Purchased							
ME							
Description	Qty	Weight	1-5	6-10	11-15	16-20	>20
68 534 PR LH	26	778	\$5,616	\$5,499	\$5,324	\$5,031	\$4,680
68 534 PR RH	26	778	\$5,616	\$5,499	\$5,324	\$5,031	\$4,680
70 534 PR LH	26	804	\$5,866	\$5,743	\$5,560	\$5,255	\$4,888
70 534 PR RH	26	804	\$5,866	\$5,743	\$5,560	\$5,255	\$4,888
30 534 HD	52	375	\$2,746	\$2,688	\$2,603	\$2,460	\$2,288
30 534 HD 4"	28	289	\$3,064	\$3,000	\$2,905	\$2,745	\$2,554
68 734 RH LH	26	910	\$6,090	\$5,963	\$5,773	\$5,456	\$5,075
68 734 PR RH	26	910	\$6,090	\$5,963	\$5,773	\$5,456	\$5,075
70 734 PR LH	26	988	\$6,564	\$6,428	\$6,223	\$5,881	\$5,470
70 734 PR RH	26	988	\$6,564	\$6,428	\$6,223	\$5,881	\$5,470
30 734 HD	52	520	\$3,145	\$3,079	\$2,981	\$2,817	\$2,621
68 814 PR LH	26	962	\$6,814	\$6,672	\$6,459	\$6,104	\$5,678
68 814 PR RH	26	962	\$6,814	\$6,672	\$6,459	\$6,104	\$5,678
70 814 PR LH	26	1014	\$7,089	\$7,385	\$6,719	\$6,350	\$5,907
70 814 PR RH	26	1014	\$7,089	\$7,385	\$6,719	\$6,350	\$5,907
30 814 HD	52	520	\$3,594	\$3,519	\$3,407	\$3,220	\$2,995
68 834 PR LH	26	1014	\$6,814	\$6,672	\$6,459	\$6,104	\$5,678
68 834 PR RH	26	1014	\$6,814	\$6,672	\$6,459	\$6,104	\$5,678
70 834 PR LH	26	1040	\$7,089	\$7,385	\$6,719	\$6,350	\$5,907
70 834 PR RH	26	1040	\$7,089	\$7,385	\$6,719	\$6,350	\$5,907
30 834 HD	52	520	\$3,594	\$3,519	\$3,407	\$3,220	\$2,995
WELDED							
Description	Qty	Weight	1-5	6-10	11-15	16-20	>20
3070 534 LH HD	26	1092	\$10,858	\$10,631	\$10,292	\$9,727	\$9,048
3070 534 RH HD	26	1092	\$10,858	\$10,631	\$10,292	\$9,727	\$9,048
3070 534 LH 4HD	26	1144	\$12,330	\$12,073	\$11,688	\$11,046	\$10,275
3070 534 RH 4HD	26	1144	\$12,330	\$12,073	\$11,688	\$11,046	\$10,275
STICKS AND MULLIONS							
Description	Qty	Weight	1-5	6-10	11-15	16-20	>20
10'3" 534 BJ	39	925	\$6,440	\$6,306	\$6,104	\$5,769	\$5,366
10'3" 534 BM	24	812	\$8,778	\$8,595	\$8,321	\$7,864	\$7,315

1. Discounts apply only to multiples of Valu-Pac units.
2. Broken pallets quantities will be at full list price.
3. Valu-Pac discount pricing not eligible for any other additional special pricing discounts.
4. For consideration of additional size or product options, please contact the factory.



DRYWALL FRAME COMPONENTS							
Discounting Applies to the Total Number of Frame ValuPac Units Purchased							
MH							
Description	Qty	Weight	1-5	6-10	11-15	16-20	>20
68 558 PR LH	26	780	\$6,090	\$5,963	\$5,773	\$5,456	\$5,075
68 558 PR RH	26	780	\$6,090	\$5,963	\$5,773	\$5,456	\$5,075
70 558 PR LH	26	832	\$6,639	\$6,501	\$6,294	\$5,948	\$5,533
70 558 PR RH	26	832	\$6,639	\$6,501	\$6,294	\$5,948	\$5,533
30 558 HD	52	364	\$2,845	\$2,786	\$2,697	\$2,549	\$2,371
68 578 PR LH	26	806	\$6,090	\$5,963	\$5,773	\$5,456	\$5,075
68 578 PR RH	26	806	\$6,090	\$5,963	\$5,773	\$5,456	\$5,075
70 578 PR LH	26	858	\$6,639	\$6,501	\$6,294	\$5,948	\$5,533
70 578 PR RH	26	858	\$6,639	\$6,501	\$6,294	\$5,948	\$5,533
30 578 HD	52	416	\$2,845	\$2,786	\$2,697	\$2,549	\$2,371
70 828 PR LH	26	1014	\$7,887	\$7,723	\$7,477	\$7,066	\$6,573
70 828 PR RH	26	1014	\$7,887	\$7,723	\$7,477	\$7,066	\$6,573
30 828 HD	52	468	\$4,193	\$4,106	\$3,975	\$3,756	\$3,494

1. Discounts apply only to multiples of Valu-Pac units.
2. Broken pallets quantities will be at full list price.
3. Valu-Pac discount pricing not eligible for any other additional special pricing discounts.
4. For consideration of additional size or product options, please contact the factory.

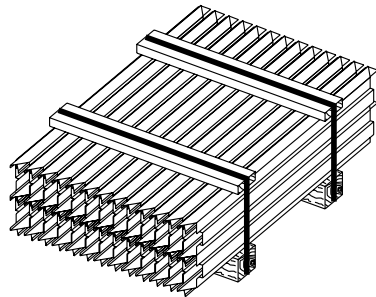
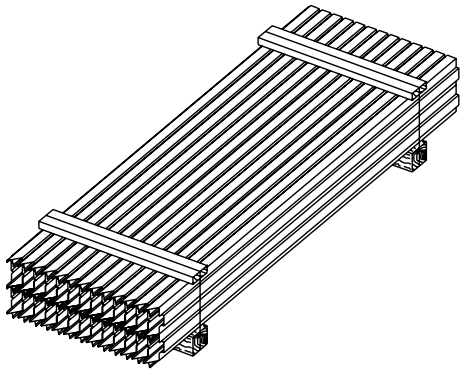



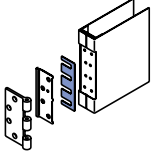
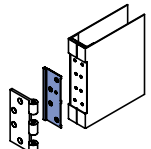
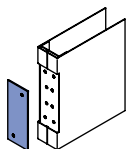

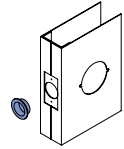
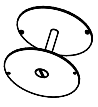
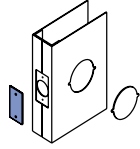
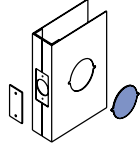
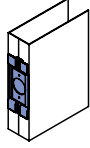
PARTS

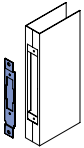
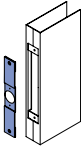
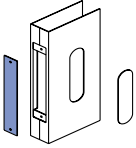
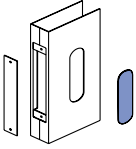
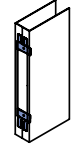

HINGE PREPARATIONS				
	Part number	Description	Pkg Qty	List each
	3980920	Uni-Fit 4-1/2" Hinge shim Heavy weight to standard weight	1 Shim	\$2.96
	3980921	Uni-Fit 5" Hinge shim Heavy weight to standard weight	1 Shim	\$2.96
	3981752	Hinge filler 1-3/4" 4-1/2" Hinge (handing plate)	1	\$1.85
	3980316	Hinge filler 1-3/4" 5.0" Hinge (handing plate)	1	\$1.85
	3830001	1-3/4" Hinge filler 4-1/2" Hinge 110FHMS #12/24	50 Filler plates 110 FHMS #12/24	\$10.56

CYLINDRICAL LOCK PREPARATIONS			
	Part number	Description	List each
	3980641	Drive-in dead bolt sleeve	\$2.83
	3831015	Cylindrical lock filler	\$26.78
	3831004	CH (161) Lock edge filler 110 FHMS #8/32	\$10.30
	3980706	Cylindrical lock punchout CH (Gov't 10 - 161)	\$2.83
	3980309	Cylindrical dead lock Tap plate	\$10.30

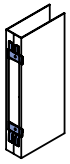
PARTS

MORTISE LOCK PREPARATIONS			
	Part number	Description	List each
	3980000	Mortise strike adaptor 2 FHMS #12/24	\$9.27
	3980300	MOL (86) Edge adaptor 2 FHMS #12/24	\$36.05
	3980301	MOL (86) Lock edge filler 2 FHMS #12/24	\$16.48
	3980707	Mortise Lock punchout Gov't. 86	\$2.83
	3980310	Mortise dead lock Tap plate 10 -24 Tap .187 offset	\$10.30

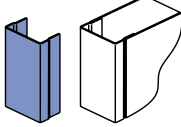
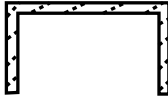
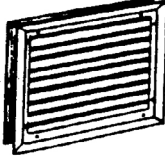
MISCELLANEOUS TAP PLATES			
	Part number	Description	List each
	3980302	Concealed vertical rod Guide tap plate 10 -32 Tap	\$9.27
	3980219	Flush bolt tap plate Used with an astragal 8 -32 Tap .085 offset	\$9.27
	3980220	Flush bolt tap plate Used without an astragal 8 -32 Tap .085 offset	\$9.27
	3980311	Auto flush bolt Top and bottom tap plate 8 -32 Tap	\$8.24

DOOR EDGE CHANNELS			
	Part number	Description	List each
	3908511	16 Gauge door Modification channel 8'0"	\$52.53
	3986339	16 Gauge blank channel 1-3/4" 8'0"	\$30.90
 	<b>Type 4 CY Louver (non-labeled) (Approx 30% free air)</b>		
	<b>Part number</b>	<b>Description</b>	<b>List each</b>
	3981042	12" x 12"	\$228.00
	3981043	18" x 12"	\$273.00
	3981044	24" x 12"	\$317.00
	3981045	24" x 18"	\$398.00
3981046	24" x 24"	\$478.00	

PARTS

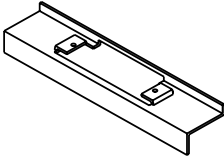
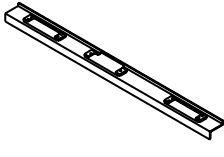
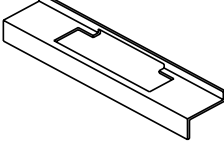
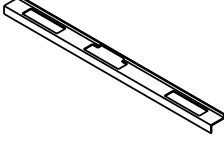
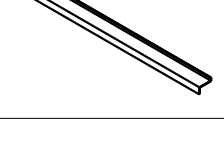
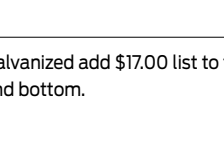
ASTRAGALS				
	Part number	Description	Includes	List each
	3801276	68 4 RH	Standard "Z" type astragal For inactive leaf Prepared for 4-7/8" strike Embossed reinforcements 1 "Z" astragal #8 x 1" PHIL OVAL HD S.D.S	\$89.00
	3801277	68 4 LH		\$89.00
	3801278	70 4 RH		\$89.00
	3801279	70 4 LH		\$89.00
	3801286	80 4 RH		\$89.00
	3801287	80 4 LH		\$89.00
	3801290	68 4 RH	Standard "Z" type astragal For inactive leaf Prepared for 4-7/8" strike Flush bolts Embossed reinforcements 1 "Z" astragal #8 x 1" PHIL OVAL HD S.D.S	\$94.00
	3801291	68 4 LH		\$94.00
	3801292	70 4 RH		\$94.00
	3801293	70 4 LH		\$94.00
	3801300	80 4 RH		\$114.00
	3801301	80 4 LH		\$114.00
	3199908	68 4 RH	Standard "Z" type astragal For inactive leaf Ch, m or mol lock provision 4-7/8" Strike standard 1 "Z" astragal 1- 3980000 Mort str adaptor 2 - 12-24 x 1/2" FHMS #8 x 1" PHIL OVAL HD S.D.S	\$89.00
	3199909	68 4 LH		\$89.00
	3199910	70 4 RH		\$89.00
	3199911	70 4 LH		\$89.00
	3199914	80 4 RH		\$89.00
	3199915	80 4 LH		\$89.00
	3199916	68 4 RH	Flush bolt "Z" type astragal For inactive leaf Ch, m or mol lock provision 4-7/8" Strike standard 1 "Z" flush bolt astragal 1- 3980000 Mort str adaptor 2 - 12-24 x 1/2" FHMS #8 x 1" PHIL OVAL HD S.D.S	\$94.00
	3199917	68 4 LH		\$94.00
	3199918	70 4 RH		\$94.00
	3199919	70 4 LH		\$94.00
	3199942	8'0"	Blank astragal For active or inactive leaf 1 "Z" astragal blank #8 x 1" PHIL OVAL HD S.D.S Top of astragal must be notched after height and hand is determined	\$61.00
	3199963	10'0"		\$72.00
	3199949	8'0"	Flat bar astragal	\$61.00
	3199950	10'0"		\$72.00

Galvanized add \$17.00 list to the above prices. Price 1-3/8 same as 1-3/4 Unless otherwise specified, flush bolts will be located 12" top and bottom.

**PARTS**

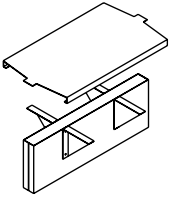
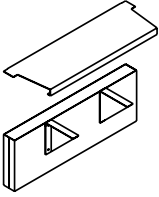
DUTCH DOOR SHELVES			
	Part number	Description	List each
	N/A	Dutch door Full Shelf 1-3/4" Only  Available in standard door widths up to 4'0" (over 4'0" consult factory)	\$696.00
	N/A	Dutch door Half Shelf 1-3/4" Only  Available in standard door widths up to 4'0" (over 4'0" consult factory)	\$412.00

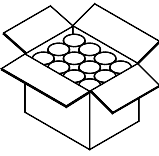
PAINT			
	Part number	Description	List each
	3933981	Air Dried Beige Primer Paint One Can (16 oz)	\$26.78

**PARTS**

ALL METAL STAMPING LOW PROFILE MODEL 110				
Glass kit size	Door size	Exposed glass	Catalog number	List each
Vision Lite	All sizes	10" x 10"	3927102	\$175.00
Narrow Lite	All sizes	5" x 20"	3927104	\$168.00
	All sizes	3" x 33"	3927130	\$192.00
	All widths 6'8" ht.	6" x 29"	3927106	\$209.00
	All widths 7'0", 7'2", 7'10", 8'0" hts.	6" x 33"	3927108	\$209.00
Half Glass	2668	16" x 29"	3927110	\$277.00
	2868, 21068	18" x 29"	3927112	\$282.00
	3068, 3268	22" x 29"	3927114	\$282.00
	2670, 2672, 26710	16" x 33"	3927116	\$270.00
	2870, 2872, 28710, 21070, 21072, 210710	18" x 33"	3927118	\$286.00
	3070, 3072, 30710, 3270, 3272, 32710	22" x 33"	3927120	\$298.00
Full Glass	3068, 3268	22" x 59"	3927122	\$431.00
	3070, 3072, 30710, 3270, 3272, 32710	22" x 63"	3927124	\$447.00

The above listed glass kits are for 1-3/4" doors.

**No Glazing Compound, Tape or Intumescent is required for most label application**

- Reduces cost
- Simplifies installation
- Improves appearance

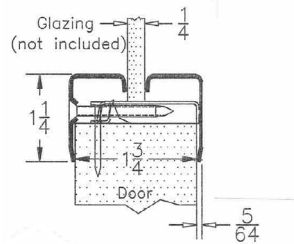

Note: For exterior applications or where glazing tape is required, kits must be ordered with additional glass pocket space.

- Example: If 1/4" glass + 1/16" glazing tape on both sides, you must order the frame for a 3/8" glass pocket (Glass Thickness).

**UL AND WH LISTED**

Meets UL10B requirements for NEGATIVE PRESSURE and UL10C & UBC 7-2(1997) for POSITIVE PRESSURE. Refer to AMS Listing Specifications. Fire tested WITHOUT glazing compound, tape or intumescent.

Broken-lot charge for less-than-package quantities: 50% of package list price. (Charge will be discounted at rate of overall order discount)

Special glass lite sizes available, consult factory.

**ORDER INFORMATION**

- Order Size – Inside dimension of frame (H + W)
- Cutout Size – Order Size + 1-1/2"
- Glass Size – Order Size + 3/4"

**MATERIAL**

- 18 gauge CRS frame is standard
- 33% thicker than 20 gauge frames
- Maintains flat appearance

**DIMENSIONS**

- Standard Frame fits 1/4" glass and 1-3/4" door

**NARROW FACE FRAME**

- Better proportioned
- Visually appealing
- Suitable for wood, metal or mineral core doors

**LOW PROFILE**

- Provides less interference for exit hardware

**NAIL IN FASTENING METHOD**

- Requires only one person to install
- Significantly reduces installation time
- Corridor side is fastener free, secure and attractive

**PARTS**

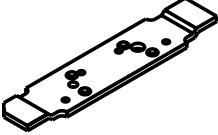
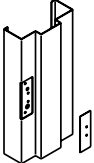
HINGE PREPARATIONS			
	Part number	Description	List each
 <p>Hinge reinforcements</p>	3832026	11 Gauge 3-1/2"	\$14.42
	3HR0300A002-GL	7 gauge 4-1/2" Universal	\$10.30
	3HR0350A002-GL	7 gauge 5" Universal	\$14.42
 <p>Hinge cover plate</p>	3832033	11 Gauge 3-1/2" Hinge filler	\$11.33
	3832034	10 Gauge 4-1/2" Hinge filler	\$11.33

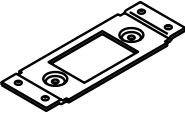
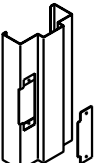
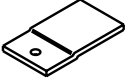
STRIKE PREPARATIONS			
	Part number	Description	List each
 <p>Strike reinforcements</p>	3832031	2-3/4" Strike	\$7.21
	3832032	4-7/8" Strike	\$7.21
 <p>Strike cover plate</p>	3832035	2-3/4" Strike filler	\$8.50
	3832036	4-7/8" Strike filler	\$8.50
 <p>Mortise dead lock tap plate</p>	3831101	Tap plate	\$4.38

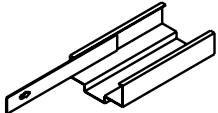
CLOSER PREPARATIONS			
	Part number	Description	List each
 <p>Closer reinforcement</p>	3832008	1-3/8" x 14" x 14 Gauge	\$5.92
	3832018	1-3/8" x 14" x 12 Gauge	\$6.44

**PARTS**

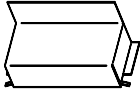
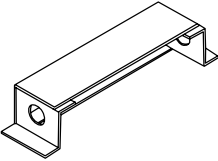
MORTAR GUARDS, JUNCTION BOXES			
	Part number	Description	List each
 Mortar guard	3833008	1-3/4" Mortar guard	\$4.38
 Junction box	3812503	Junction box 14" with knockouts	\$33.00
	3812504	Junction box 8" with knockouts	\$33.00

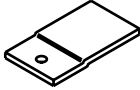

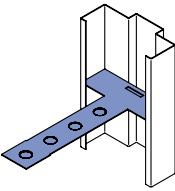
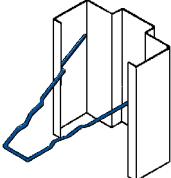
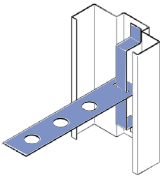
FLUSH BOLT STRIKE PREPARATIONS			
	Part number	Description	List each
 Reversible FB strike	3981475	1 Set reinforcing and strike plate	\$21.12
 Automatic flush bolt Tap plate	3981049	Tap plate	\$4.38

ANCHORS			
	Part number	Description	List each
	3832037	4-3/4 " Masonry T anchor	\$3.25
	3832038	5-3/4 " Masonry T anchor	\$3.25
	3832039	6-3/4 " Masonry T anchor	\$3.25
	3832078	7-3/4 " Masonry T anchor	\$3.25
	3832040	8-3/4 " Masonry T anchor	\$3.25
	3AN0156P001	Wire masonry anchor	\$3.00
	3832045	Adjustable masonry anchor assembly	\$8.25

GENERAL  
DOORS  
FRAMES  
SPECIALTY  
STICKS  
ENGINEERING  
VALU-PAC  
DOOR PARTS  
FRAME PARTS  
HARDWARE

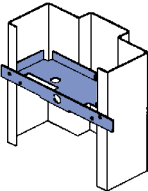
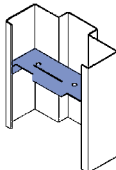
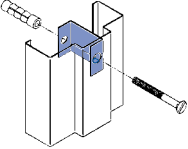
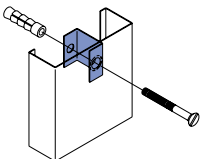
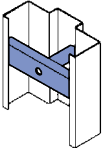
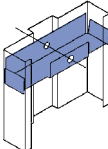
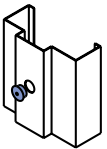

**PARTS**



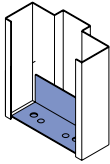
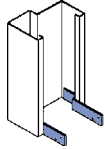
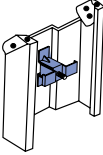
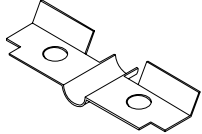
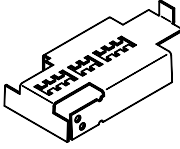
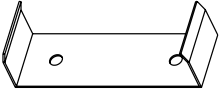
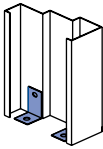
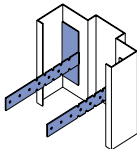
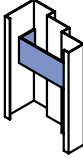

ANCHORS			
	Part number	Description	List each
	3AN0100P020-GL	4-3/4" Wood stud anchor	\$3.25
	3AN0100P016-GL	5-3/4" Universal wood stud	\$3.25
	3AN0100P014-GL	6-1/4" Wood stud anchor	\$3.25
	3AN0100P012-GL	6-3/4" Wood stud anchor	\$3.25
	3AN0100P008-GL	7-3/4" Wood stud anchor	\$3.25
	3AN0100P006-GL	8-1/4" Wood stud anchor	\$3.25
	3AN0100P004-GL	8-3/4" Wood stud anchor	\$3.25
	3AN0103P001-GL	4-3/4" Steel stud anchor	\$3.25
	3AN0103P002-GL	5-3/4" Steel stud anchor	\$3.25
	3AN0100P014-GL	6-1/4" Steel stud anchor	\$3.25
	3AN0103P003-GL	6-3/4" Steel stud anchor	\$3.25
	3AN0103P004-GL	7-3/4" Steel stud anchor	\$3.25
	3AN0100P006-GL	8-1/4" Steel stud anchor	\$3.25
	3AN0103P005-GL	8-3/4" Steel stud anchor	\$3.25
	3AN0020P014-GL	Universal frame prepared opening anchor (bolt not included)	\$4.25
	3AN0020P012-GL	Cased opening prepared anchor (bolt not included)	\$4.25
	3980668	Twist-in prepared opening anchor 4-3/4"-5-3/4"	\$8.50
	3981452	5-3/4" Snap-in prepared opening anchor with plastic hole plugs	\$5.50
	3981451	Plastic hole plugs	\$0.26
	3981088	3/8" x 5" Sleeve anchor	\$8.00

### PARTS

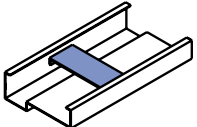
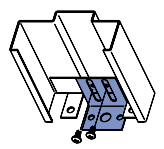
ANCHORS			
	Part number	Description	List each
	3AN0253P002-GL	4-3/4" to 5-5/8" One piece sill anchor	\$3.25
	3AN0253P003-GL	5-3/4" to 6-5/8" One piece sill anchor	\$3.25
	3AN0253P004-GL	6-3/4" to 7-5/8" One piece sill anchor	\$3.25
	3AN0253P005-GL	7-3/4" to 8-5/8" One piece sill anchor	\$3.25
	3AN0253P006-GL	8-3/4" to 9-5/8" One piece sill anchor	\$3.25
	3812100	Double rabbet sill anchor MH and SH frames	\$3.25
	3812099	Single rabbet sill anchor MH and SH frames	\$3.25
	3AN0175A001-GL	Drywall pressure anchor	\$6.70
	3933950	Butterfly anchor 4-1/2" to 7"	\$5.50
	3832045	Adjustable wood/steel stud anchor half (6-3/4" max)	\$4.25
	3832074	4-3/4" Base anchor for sticks	\$12.60
	3832075	5-3/4" Base anchor for sticks	\$12.60
	3832076	6-3/4" Base anchor for sticks	\$12.60
	3832077	8-3/4" Base anchor for sticks	\$12.60
	3399000	Double egress sill anchor (each)	\$3.25
	3399004	Double egress wood stud anchor (each)	\$5.25
	3399002	Double egress steel stud jamb anchors	\$5.25

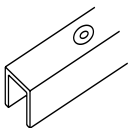
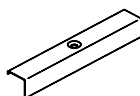
**PARTS**

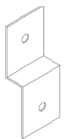
ANCHORS			
	Part number	Description	List each
	3399003	Double egress steel stud head anchors	\$5.25
	3AN0167P002-GL	5-3/4" Adjustable sill anchor (plate)	\$6.25
	3AN0251P001-GL	5-3/4" Adjustable sill anchor (strap)	\$6.25

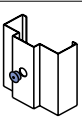
GLAZING BEAD/STOP EXTENSION/MISC. ITEMS			
	Part number	Description	List each
 Glazing bead	3909837	3/4" x 5/8" x 10' Pre-punch galvanized	\$41.00
 3/4" High stop extension	3934009	20 Gauge 10'0"	\$44.17
 Spreader bar	3832022	10'0" Spreader bar	\$30.00
 Clip for removable panel	3980866	Z Clip	\$4.70
 Self-sticking door mutes	3842021	Self-sticking door mutes	\$0.41
 Mutes	3904409	Mutes	\$0.58
 Drywall hole plugs	3812101	Drywall hole plugs	\$0.57

**PARTS**

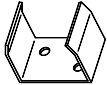
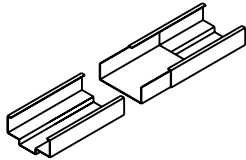
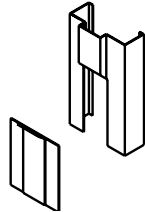
GLAZING BEAD/STOP EXTENSION/MISC. ITEMS			
	Part number	Description	List each
 Mullion clip	3832064	Mullion clip	\$16.00
 Splice channel	3832060	4-3/4" Splice channel	\$19.00
	3832061	5-3/4" Splice channel	\$19.00
	3832062	6-3/4" Splice channel	\$19.00
	3832063	8-3/4" Splice channel	\$19.00
Image not available	3980677	Full length 12 gauge channel (5-3/4" x 6')	\$250.00
 Hospital stop kit	3811115	4-3/4" Hospital stop kit	\$31.00
	3811116	5-3/4" Hospital stop kit	\$31.00
	3811117	6-3/4" Hospital stop kit	\$31.00
	3926423	7-3/4" Hospital stop kit	\$31.00
	3811118	8-3/4" Hospital stop kit	\$31.00

PARTS

SCREWS			
Part number	Description	Size	List each
3980324	CH-Lock front cover plate, 2-3/4" Strike cover plate, special strikes	#8 - 32 x 1/2" U.C. FHMS (Phillips Flat head undercut machine screw zinc plated)	\$0.19
3980327	Door and frame hinge cover plates - 4-1/2" MOL lock face cover plate	#12 - 24 x 1/2" U.C. FHMS (Flat head undercut machine screw)	\$0.19
3980556	Labels	#6 x 1/2" OHDS (Oval head)	\$0.31
3831089	Aluminum and steel-stick glazing bead clips	#8 x 3/8" Type A Binding HD STS (Self-tapping screw)	\$0.19
3710000	Steel muntin bar clips, steel muntin bar sets	#8 x 3/8" Phil Type B FHSTS (Flat head self-tapping screw)	\$0.25
3911094	Astragals and UL glazing bead	#8 - 1" OH Phil Tek Z Zinc (Oval head)	\$0.31
3911093	Glazing bead	#8 x 1-1/4" Phil OH SDS (Oval head self-drilling screw)	\$0.37
3981565	Non-labeled wood stud applications with prepared openings	#20 x 5" Wood screw	\$2.78

Broken-lot charge for less-than-package quantities: 50% of package list price.  
 (Charge will be discounted at rate of overall order discount).

## HARDWARE

### CLOSERS, HINGES, AND EXIT DEVICES

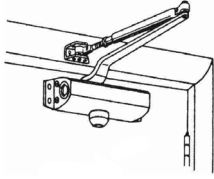
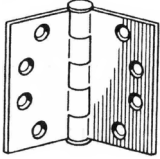
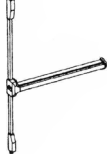
	Catalog number	Description	List each
	3727006	Tri-pack closer - Heavy duty, 48" wide interior or 36" wide exterior door, aluminum with back check	\$410.00
	3727007	Tri-pack closer - Medium duty, 48" wide interior or 36" wide exterior door, aluminum with back check	\$244.00
	3720287	Closer cover	\$30.00
	3727503	4.5" x 4.5" Ball bearing hinges - USP NRP hinges (each)	\$18.00
	3727502	4.5" x 4.5" Ball bearing hinges - 26D NRP hinges (each)	\$21.00
	3727501	4.5" x 4.5" Ball bearing hinges - 26D hinges (each)	\$15.00
	3727505	4.5" x 4.5" Plain hinges - USP hinges (each)	\$16.00
	3727504	4.5" x 4.5" Plain hinges - 26D hinges (each)	\$10.00
	3720070	Continuous hinge - 7 ft. Aluminum full mortise hinge	\$498.00
	3720071	Continuous hinge - 7 ft. Aluminum full surface hinge	\$751.00
	3720470	Rim, reversible exit device - Aluminum finish adjustable for doors 25" - 36" wide	\$362.00
	3720017	Entry lever trim - Lever trim with clutch solid tailpiece on solid brass	\$316.00

### DOOR PLATES, STOPS, BOLTS, SWEEPS, AND LOCKSETS

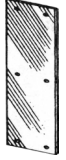
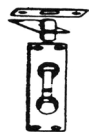
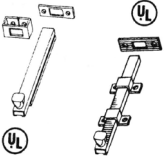
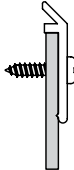
	Catalog number	Description	List each
	3908272	Pull plate - 3-1/2" x 15" aluminum	\$53.00
	3908271	Push plate - 3-1/2" x 15" aluminum	\$17.00
	3720331	Flush bolt - U.L. Listed, 1" x 6-3/4" dull chrome (each)	\$89.00
	3720336	Heavy duty U.L. surface bolt - Zinc plated with exposed screws	\$44.00
	3720026	36" Sweep	\$44.00
	3720027	48" Sweep	\$57.00

GENERAL

DOORS

FRAMES

SPECIALTY

STICKS



ENGINEERING

VALU-PAC

DOOR PARTS

FRAME PARTS

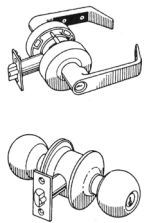
HARDWARE

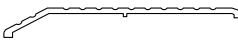
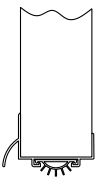
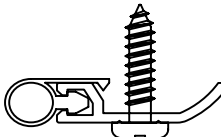
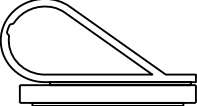
DOOR PLATES, STOPS, BOLTS, SWEEPS, AND LOCKSETS			
	Catalog number	Description	List each
	3720170	Entry lock boxed - Dull chrome keyed different	\$251.00
	3727003	Privacy locked boxed - Dull chrome - Grade 2(F76)	\$139.00
	3720021	Passage set boxed - Dull chrome	\$228.00
	3720149	Heavy duty single cylinder deadbolt with solid bar construction - Stainless steel	\$80.00
	3720022	Kick plate - Stainless steel, satin finish, 8" x 34"	\$97.00
	3720023	Kick plate - Stainless steel, satin finish, 10" x 34"	\$121.00
	3720028	Saddle threshold - 1/2" x 5" x 36" x AL (U.L. and ADA)	\$102.00
	3720029	Saddle threshold - 1/2" x 5" x 72" x AL (U.L. and ADA)	\$202.00
	3720030	Lipped threshold - 5/8" x 5" 36" x AL (U.L.)	\$144.00
	3720031	Lipped threshold - 5/8" x 5" 72" x AL (U.L.)	\$287.00
	3720041	Door shoe - 36" x AL with gray vinyl insert	\$46.00
Image not available	3720039	41" Rain drip	\$57.00
Image not available	3720040	76" Rain drip	\$105.00
	3720032	Screw on weatherstrip - 36"	\$129.00
	3720033	Screw on weatherstrip - 72"	\$165.00
	3720034	Stick on weatherstrip - 17'	\$51.00
	3720035	Stick on weatherstrip - 21'	\$63.00
	3720036	Stick on weatherstrip - 25'	\$77.00

## About Allegion

Allegion (NYSE: ALLE) is a global pioneer in seamless access. We keep people and their assets safe, wherever they are, bringing together simple solutions, convenient access and advanced technology.

For more, visit [www.allegion.com](http://www.allegion.com)

KRYPTONITE ■ LCN ■  ■ STEELCRAFT ■ VON DUPRIN