

New Product Updates

Date: February 2nd, 2024



6300 / 6400 Exit Device

Page 132:

- 630F, Full Stainless Steel, finish added to Wide/Narrow Stile Rim Exits
- Delayed Egress, DE, added to Electrified Options for Wide/Narrow Stile Rim Exits

Page 133:

- 630F finish added to How to Order guide and Price Lists
- DE added to How to Order guide

Page 134: DE added to Electrified Options Price List

Page 135: 630F finish added to Wide/Narrow Stile Surface Vertical Rod Exits

Page 136-137: 630F finish added to How to Order guide and Price Lists

Page 139:

- 630F, Full Stainless Steel, finish added to Wide/Narrow Stile Concealed Vertical Rod Exits
- Delayed Egress, DE, added to Electrified Options for Wide/Narrow Stile Concealed Vertical Rod Exits

Page 140:

- DE added to How to Order guide
- 630F finish added to How to Order guide and Price Lists
- CWD - Wood Door designation added to How to Order guide

Page 141: 630F finish added to Price List

Page 142: DE added to Electrified Options Price List

Page 143:

- 630F, Full Stainless Steel, finish added to Mortise Exit
- Delayed Egress, DE, added to Electrified Options for Mortise Exit

Page 144:

- 630F finish added to How to Order guide and Price List
- DE added to How to Order guide

Page 145: DE added to Electrified Options Price List

Page 146: 630F finish added to Dummy Exit Device

Page 147: 630F finish added to How to Order guide and Price List

Page 217: DE added to Electrified Solutions

Hinges

Page 225: 622, Black, finish added to How to Order guide

Page 226:

- 622 finish added to Plain Bearing Price List. Model #35 ST PL 4545 622
- 622 finish added to 2 Ball Bearing Price List. Model #35 ST BB 4545 622 NRP and #35 SS BB 4545 622 NRP

Page 227:

- 622 finish added to Spring Hinges Price List. Model #35 ST SH 4545 622
- 622 finish added to 4 Ball Bearing Price List. Model #35 ST HB 4545 622 NRP

COMING IN Q2, 2024!



Grip Pull Trim

6GW Trim for 6300 / 6400 Exit Devices

Strikes

9910 Electric Strike for 6300 / 6400 Exit Devices



PRICE BOOK

EFFECTIVE JULY 3rd, 2023

SECURING
CONFIDENCE.
OPENING
POSSIBILITIES.



Customer Support

Customer Support

Our Customer Support team is available to answer questions or provide any assistance you may need.

717.656.4281, help@pdqlocks.com.

Monday through Friday – 8am to 5pm EST.

Placing Orders

To place orders, email:

orders@pdqlocks.com

Product and Technical Support

PDQ Mechanical: 833.273.7832, support@pdqlocks.com

Quotation and Product Cross Reference

quotes@pdqlocks.com, 717.656.4281

Value Engineering Services (Complimentary)

quotes@pdqlocks.com, 717.656.4281

Specification Writing Services (Complimentary)

quotes@pdqlocks.com, 717.656.4281

World Headquarters Administrative Office U.S. Manufacturing Center

PDQ Manufacturing
2230 Embassy Drive
Lancaster, PA 17603 USA

Remittances

PDQ Manufacturing
P.O. Box 6426
Lancaster, PA 17607 USA

Regional Distribution Centers

Lancaster, PA, Norcross, GA, Auburn, WA

International Sales and Distribution Centers

Abu Dhabi, United Arab Emirates

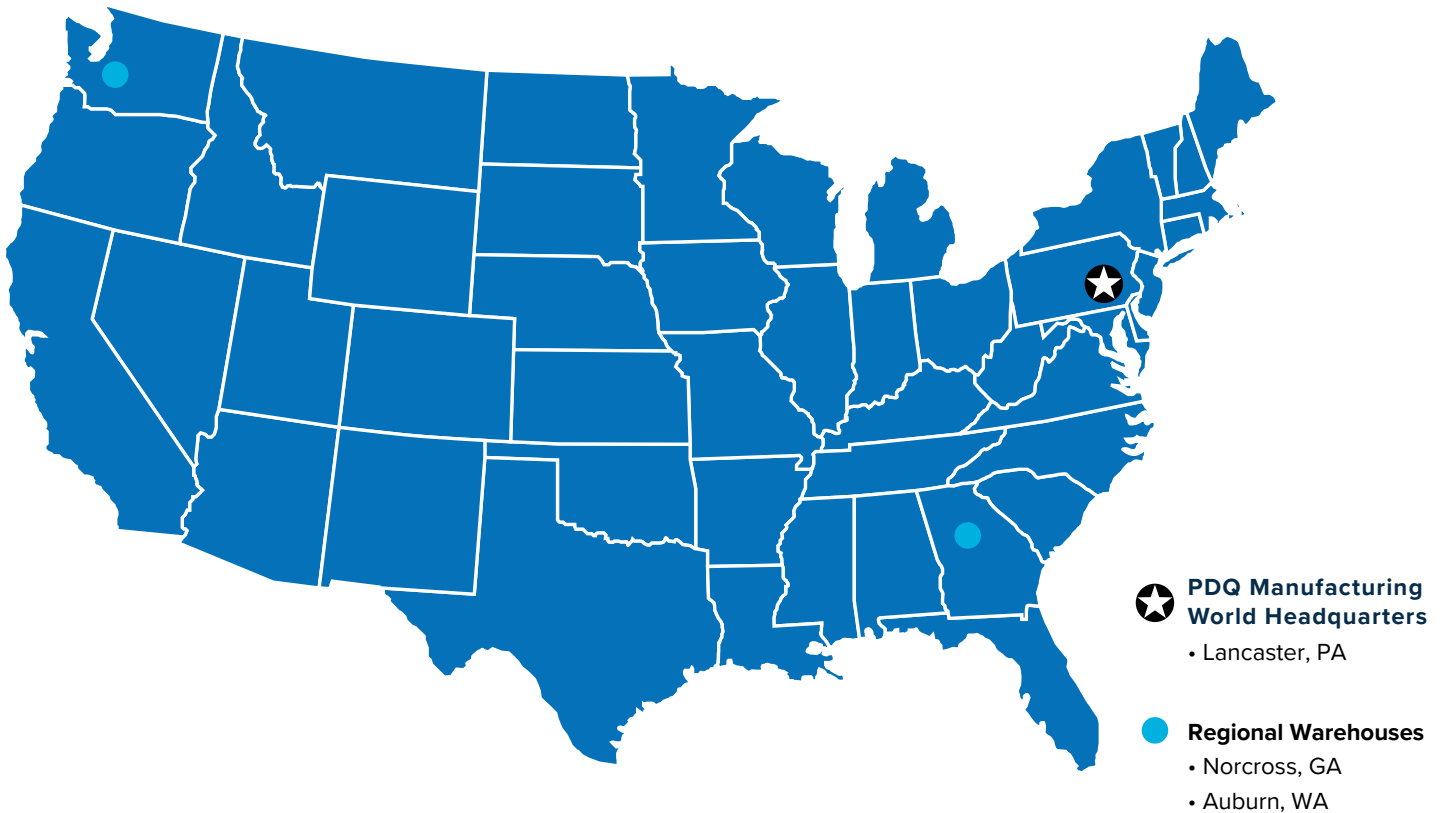



Table of Contents

| | | | |
|---|------------|-------------------------------------|------------|
| Common Pricing Information | 6 | Door Closers | 188 |
| Terms & Conditions | 7 | 7100 Series Grade 1 Closer | 189 |
| Warranty | 8 | 5100 Series Grade 1 Closer | 195 |
| Mortise Locks | 9 | 5300/5500 Series Grade 1 Closer | 201 |
| MR Series Grade 1 Mortise | 9 | 3100 Series Grade 1 Closer | 208 |
| TJ Tubular Trim Suite | 31 | SCS Spring Cushion Stop | 216 |
| Cylindrical Locks Grade 1 | 35 | Electrified Solutions | 217 |
| XGT/GT199A Series Grade 1 Electrified Cylindrical | 36 | Electric Strikes | 219 |
| XGT/GT135LED Classroom Intruder | 37 | Key Switches and Push Buttons | 220 |
| XGT Series Grade 1 Cylindrical | 38 | Power Supplies | 221 |
| GT Series Grade 1 Cylindrical | 48 | Hinges | 222 |
| SX Series Grade 1 Ball Knob | 59 | Commercial Hinges | 223 |
| Cylindrical Locks Grade 2 | 65 | Electrified Hinges | 228 |
| GP Series Grade 2 Cylindrical | 66 | Flat Goods | 229 |
| SD Series Grade 2 Cylindrical | 74 | Flush and Surface Bolts | 231 |
| SF Series Grade 2 Cylindrical | 82 | Coordinators | 234 |
| CL Series Inter-Connected Grade 2 | 87 | Push Plates | 237 |
| SV Series Grade 2 Ball Knob | 94 | Pulls and Pull Plates | 239 |
| Deadbolts | 100 | Push and Push-Pull Bars | 246 |
| KM Series Heavy Duty Bored Deadbolt — Rim Cylinder | 101 | Fasteners | 248 |
| KT Series Heavy Duty Bored Deadbolt — Mortise Cylinder | 106 | Door Protection Plates | 249 |
| KV Series Commercial Duty Bored Deadbolt — Rim Cylinder | 110 | General Hardware | 251 |
| MJ Mortise Cylinder Deadbolt | 113 | Sliding Barn Door Hardware | 255 |
| Padlocks, Euro Profile | 115 | Key Systems and Keying Forms | 257 |
| PL Series Padlock | 115 | | |
| EPIC Series European Profile Interchangeable Core | 117 | | |
| Cylinders, Keying Systems and Keys | 119 | | |
| High Security Cylinders & Cores | 120 | | |
| Cylinders | 121 | | |
| Interchangeable Cores, Housings, Cams | 125 | | |
| Keys & Keying Systems | 127 | | |
| Exit Devices | 130 | | |
| 6300/6400R Rim | 132 | | |
| 6300/6400V Surface Vertical Rod | 135 | | |
| 6300/6400C Concealed Vertical Rod | 139 | | |
| 6300M Mortise | 143 | | |
| 6300D Dummy | 146 | | |
| 6300/6400 Parts | 153 | | |
| 6300/6400 Trim | 158 | | |
| 9300 Mullions | 174 | | |
| 4200 Commercial Exit Device | 177 | | |
| 4200R Rim | 179 | | |
| 4200V Surface Vertical Rod | 180 | | |
| 4200 Trim | 181 | | |

Common Pricing Information

| | |
|-----|--|
| 1. | Locks are furnished with standard features unless otherwise specified. |
| 2. | Door thickness is 1-3/4" unless otherwise specified. |
| 3. | Split finishes and designs will be priced at the highest list price of the design and/or finish + lock adjustment. |
| 4. |  Light blue shaded cell denotes a lock or part that requires an extended lead time. |
| 5. |  denotes a handed product and requires handing to be specified. |
| 6. | For all restricted keyways (TA, PDQ3) and additional high security and restricted keyways see page 125. |
| 7. | Locks, keys and cylinders containing restricted keyways require additional documentation to order. A letter of authorization on the end user's stationary must be submitted with the initial order to establish the authorized ship to location. |
| 8. | Keyway must be specified for keyed functions and cylinder. If not specified, the default keyway will be SCC. |
| 9. | Multiple keying options are available. Locks and cylinders are furnished KD unless otherwise specified or excepted by notation. |
| 10. | Control Keys for permanent and construction cores are not included with the lock or cylinder and must be ordered separately. |
| 11. | Stamping standards and charges are listed on page 126. |
| 12. | Locks and cylinders will be furnished with 2 keys each as standard. Additional keys will be charged at the additional cut key charge appropriate for the cylinder/key type. |

Customer Support

| | | |
|--------------------------|-----------------------------|--|
| Customer Service | 717.656.4281 | help@pdqlocks.com |
| Placing Orders | | orders@pdqlocks.com |
| Technical Support | 833.2-PDQTEC (833.273.7832) | support@pdqlocks.com |
| Quotation | 717.656.4281 | quotes@pdqlocks.com |

This Price List Supersedes and Cancels All Previous Price Lists. Prices Shown are Subject to Change Without Notice.

Terms & Conditions

Prices

All prices are subject to change without notice. All prices are per unit (each) unless otherwise specified and do not include freight. All prices are in U.S. dollars.

Errors and Omissions

While PDQ Manufacturing makes every effort to provide an accurate price list, we are not responsible for errors and/or omissions that may appear. Customers will be invoiced the actual and true price on all orders.

Credit Terms

Standard credit terms are 1% 10 days net 30. Net 30 days payment must be received by PDQ on or before 30 days from the date of the invoice. Interest will be charged at the rate of 1-1/2% per month on past due accounts. A \$25.00 fee will be charged for all returned payments.

Acceptance of Orders

Possession of prices from PDQ Manufacturing does not commit PDQ to accept any order. PDQ Industries reserves the right to refuse any order or request for quotation and will not be bound to fill any order until it has been accepted by a representative of PDQ and confirmed by a written acknowledgment. Quotations are valid for the period stated on the official quotation request form. Orders must be submitted in writing.

Acknowledgments

An Acknowledgment is an exact copy of a customer's order as entered by PDQ and should be verified by the customer. If the Acknowledgment does not agree with customer's understanding, PDQ should be advised within three (3) days or the order will be billed as acknowledged. PDQ Manufacturing's sales terms shall apply irrespective of any special stipulation appearing in customer orders, unless specifically acknowledged and accepted by PDQ Manufacturing, Inc. Estimates of delivery are made by PDQ Manufacturing in good faith and are not guaranteed. PDQ Manufacturing does not assume responsibility for delay in deliveries.

Product Will Call Orders

Product Will Call orders shall be picked-up within 3 working dates from the available date shown on the acknowledgment. Orders not picked-up after the 3 days shall be subject to cancellation charges.

Product Return

Products may not be returned unless customer receives written authorization from PDQ. If the return is authorized by PDQ a Return Goods Authorization (RGA) number will be issued to the customer. Products returned must have the RGA number clearly marked on the outside of the box and reach PDQ within 45 days from the date RGA is issued. All documentation and RGA number must accompany the return along with the original invoice number and an explanation why the material is being returned so that PDQ may inspect the material in question. Only material that has been in customer's inventory for less than 60 days from the invoice date, is current standard, non-obsolete and not specially manufactured, unused and in their original condition and original packaging will be considered for return. Master keyed items cannot be returned for credit. If the product is accepted for a return there will be minimum 35% processing charge of the net material value on the original invoice, less freight and cash discounts. Full credit against future purchases or replacements will be made at the option of PDQ. Care must be taken to package all returns to ensure that they are not damaged in shipment. PDQ will not credit items returned that have not been properly packed and as a result sustain damage in shipment back to our facility

Force Majeure

PDQ will not be held responsible for delays in delivery caused by Strikes, acts by government agencies, fires, floods or any other causes beyond our control, including the delivery of material to us. Under no circumstances shall PDQ be liable or accountable for consequential damages due to failure of delivery.

Invoices

Copies of invoices and sales orders are posted and accessible on PDQ's website. Contact Customer Service for obtaining secured access authorization. Invoices are in U.S. dollars.

Minimum Order

Minimum order is \$100 net invoice value at current buying program, less freight.

Changes or Cancellations

Changes or cancellations to an order acknowledged must be made in writing subject to a 50% cancellation fee.

Claims

Every possible care is taken in the final examination and packing of goods, and no complaints can be entertained unless made promptly on receipt of goods. No claim will be allowed for work done by others, consequential damages, or other expenditure, and PDQ's undertaking to repair or replace defective goods is its only liability. No claim for damage, shortage or loss in transit will be considered unless notice in writing is given to the carrier and to PDQ Industries within ten (10) days.

Back Charges

PDQ is not responsible for, does not authorize, and will not accept any charges for the cost of labor or material incurred by anyone other than PDQ Manufacturing for any installation, repair, service or replacement unless incurred with PDQ's prior written consent and agreement.

Freight Charges

FOB point is Lancaster, PA, Norcross, GA, or Auburn, WA. Ship location is at factory discretion. Freight is prepaid if invoice exceeds \$3,000 net. Air freight and other special shipments are not deductible. Freight allowance methods are at the discretion of PDQ. C.O.D. freight charges are paid by consignee.

Credit Card Payments

When paying by credit card a 3% surcharge will be added to the invoice at time of payment.

Discontinuance

PDQ Manufacturing reserves the right to discontinue or change any price, product, design, function and finish without notice.

Quotations and Invoices

Quotations and Invoices are the proprietary property of PDQ Distributors and the Company. Distributors are not permitted to redistribute quotations or invoices to third parties. Any redistribution may result in the loss of the distributor's rights to the PDQ product line.



Warranty

PDQ Manufacturing Limited Warranty

| Grade 1 Lock Product | |
|---|---------------------------|
| MR Series Mortise Locks | Limited Lifetime Warranty |
| XGT Series | Limited Lifetime Warranty |
| GT Series | 25-Year Warranty |
| SX Series | 5-Year Warranty |
| Grade 2 Lock Product | |
| GP Series | 8-Year Warranty |
| SD Series | 5-Year Warranty |
| SF Series | 3-Year Warranty |
| SV Series | 1-Year Warranty |
| CL Series | 2-Year Warranty |
| TJ Series Decorative Tubular | |
| TJ Series | 5-Year Warranty |
| Deadbolts | |
| K Series | 1-Year Warranty |
| Closers | |
| 3100 Series | 25-Year Warranty |
| 5100 Series | 25-Year Warranty |
| 5300 Series | 25-Year Warranty |
| 5500 Series | 25-Year Warranty |
| 7100 Series | 25-Year Warranty |
| Exit Devices | |
| 4200 Series | 5-Year Warranty |
| 6300 Series | 10-Year Warranty |
| 6400 Series | 10-Year Warranty |
| Mullions | |
| Mullions | 10-Year Warranty |
| Hinges, Flat Goods and Sliding Barn Door Hardware | |
| Commercial Hinges | 5-Year Warranty |
| Flat Goods | 5-Year Warranty |
| Sliding Barn Door Hardware | 5-Year Warranty |
| Electrified Products | |
| Mechanical Components | Series Warranty |
| Electric Components | 2-Year Warranty |

PDQ Manufacturing ("PDQ") warrants that, during the applicable warranty period set forth in the chart to the left, its products will be free from defects in workmanship and materials under normal use and service conditions. If a product or a component part thereof is found to be defective, PDQ will, at its sole discretion, either repair or replace such defective item. If PDQ no longer manufactures the particular product or component, PDQ reserves the right to substitute an item which PDQ deems to be comparable or superior in its place.

A warranty claim must be initiated by calling PDQ's toll-free number at 800.441.9692. A brief description of the defect will be required, and further instructions for returning the product will be given. The provision of return instructions is not a guarantee that the product will be covered under this warranty.

This warranty does not cover:

- Defects or damage arising from improper installation; lack of or improper maintenance; improper storage, shipping or handling; corrosion; erosion; ordinary wear and tear; misuse or abuse; or accident.
- Products which have been modified in any way, regardless of whether such modification caused or contributed to the alleged defect.
- The protective coatings and finishes applied to the surface of the product (wear or tarnishing of such finishes is considered "ordinary wear and tear").
- Labor costs, including the costs of removing and reinstalling the product.
- Shipping charges incurred in returning the product to PDQ.
- This Limited Warranty does not apply to ANSI A156.2 Grade 2 Key-In-Lever product installed on Educational Facilities.

All products returned to PDQ will be inspected to verify that (1) the alleged defect does exist, and (2) none of the exclusionary conditions listed above (abuse, corrosion, modification, etc.) is present. Products deemed not to be "in warranty" will be returned to the customer at the customer's expense.

This warranty is exclusive and in lieu of all other warranties, express and implied, including the implied warranties of merchantability and fitness for a particular purpose.

PDQ's maximum liability hereunder is limited to the original purchase price of the product.

PDQ shall not be liable for any incidental, consequential, indirect, special, exemplary or punitive damages, whether based on contract, warranty, tort (including strict liability and negligence), patent infringement or any other theory of liability, even if advised of the possibility of such damage.

No agent, sales representative or dealer has the authority to increase or alter PDQ's obligations under this warranty.



ASSEMBLED
IN THE USA

Designed to Over-Perform

Tested to 11 million cycles and still counting! That's how PDQ backs up its claim to manufacture some of the toughest hardware in the market. Our mortise locks are built to withstand the rigors of daily use without fail, keeping people and their assets safe while delivering consistent reliable performance. Easy to install, and simple to repair and maintain. That means fewer callbacks for you and total safety and security for your customers.

Comprehensive Offering

MR Mechanical



Applications

Healthcare, K-12, higher education, offices, commercial buildings and government facilities.

MR199A Electro-Mechanical

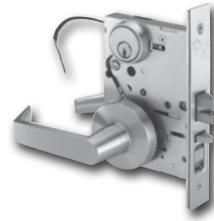

Applications

Computer rooms, storage areas, child care facilities, restrooms, nursing staff lounges and stairwell towers.

MR Visual Indicators



Applications

Classroom security, student housing and traditional OCCUPIED/VACANT and LOCKED/UNLOCKED applications.

TJ Tubular Trim Suite



Applications

Interior doors in high-end residential, multi-family and commercial spaces. Trim matches MR mortise achieving a coordinated look throughout the property.

Lock Status at a Glance

PDQ's MR Series mortise lock indicators offer exceptional visibility and flexibility. The unique features of the indicator make it ideally suited for classroom security applications as well as traditional occupied/vacant applications.

Typical Applications

- Classroom Security
- LOCKED/UNLOCKED Applications
- Student Housing
- Traditional OCCUPIED/VACANT Applications



Features and Functions

- Conforms to ANSI Z535.1 Safety Colors: Red and Green
- Optional Security Screws Available
- Intruder Deadbolt with Dead-latch for School Security Applications
- Dormitory Security
- Faculty Restroom with Deadbolt w/Indicator
- Privacy w/Indicator
- Privacy with Deadbolt w/Indicator
- Privacy with Deadbolt and Egress w/Indicator



MR 199A MR200

Electrified Mortise Solutions



ASSEMBLED
IN THE USA

MR199A Electrified Storeroom MR200 Electrified Institutional

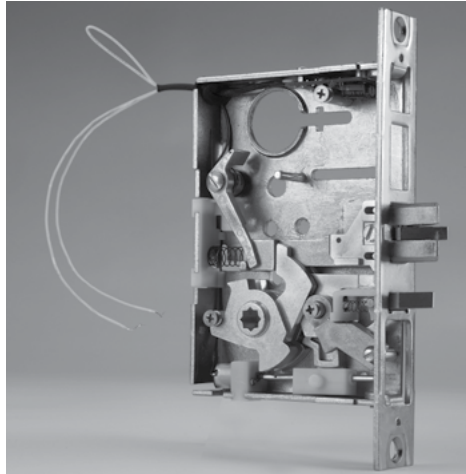

Innovative motor drive controls
FAIL SECURE or FAIL SAFE locking
mode.

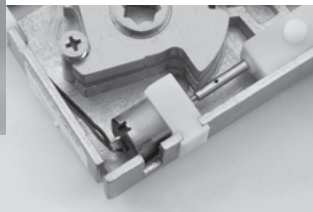

Typical Applications

- Child Care Facilities
- Computer Rooms
- Nursing Staff Lounges
- Rest Rooms
- Stairwell Towers
- Storage Areas

Features

- Motorized locking/unlocking.
- **FAIL SECURE** (Factory Default)– Outside trim is UNLOCKED when power is ON, and LOCKED when power is OFF. Lockset will lock in the event of a power failure.
- **FAIL SAFE** – Outside trim is LOCKED when power is ON, and UNLOCKED when power is OFF. Lockset will unlock in the event of a power failure.
- Field changeable from FAIL Secure to FAIL SAFE.
- Built around PDQ's world class MR series mortise lock chassis platform.
- Meets requirements of the Buy American Act.
- SMARTSENSE™ control board automatically accepts AC or DC input voltage.
- Request to exit option.
- Latch bolt monitor option.
- Field reversible handing - consult factory.

Specifications



| | |
|---|--|
| PERFORMANCE: | <ul style="list-style-type: none"> • Motor drive factory tested to over 1.4 million cycles (nearly 3x the ANSI/BHMA Grade 1 Standard). |
| RECOMMENDED POWER SUPPLY: | <ul style="list-style-type: none"> • PDQ Model # PS220. <ul style="list-style-type: none"> – Input: 110-120 VAC 60Hz – Output: 24VDC, 2A, filtered and regulated. • Rated for simultaneous operation of 2ea mortise lock assemblies. • Power Supply Requirements: <ul style="list-style-type: none"> – AC/DC Output Voltage – 1A min (filtered and regulated). • 12-24VDC @ < 1A initial surge (1 sec), 5mA standby after 30 sec. <ul style="list-style-type: none"> – AC Output Voltage. • 12-24VAC (60Hz) @ < 1A initial surge (1 sec), 15mA standby after 30 sec |
| ELECTRICAL SPECIFICATIONS: | <ul style="list-style-type: none"> • Input voltage: 12-24VDC or 12-24VAC. • Max In-rush current: 1.0A. • Standby current: <ul style="list-style-type: none"> – 12VAC: 12mA. – 24VAC: 10mA. – 12VDC: 3mA. – 24VDC: 5mA. <p>Note: Operating voltage at ± 10% of rated voltage.</p> |
| CERTIFICATIONS, LISTINGS, COMPLIANCES: | <ul style="list-style-type: none"> • ANSI/UL10C and CAN/ULC-5104 Listed for "Fire Exit Hardware" up to 3 hours for 4'0" x 8'0" maximum single, 8'0" x 8'0" maximum pairs. • Assembled in the U.S.A. with U.S. and foreign material. Meets requirements of the Buy American Act as a COTS product manufactured in the United States. |
| WARRANTY: | <ul style="list-style-type: none"> • 2-Years |

MR SERIES

Grade 1 Mortise



ASSEMBLED
IN THE USA

Typical Applications

- Assisted Living
- Government Facilities
- Healthcare
- Hospitality
- Houses of Worship
- Industrial
- Multi-family
- Offices
- Public Buildings
- Retail
- Higher Education
- K-12 Education



Specifications



| | |
|---|---|
| FOR DOORS: | • 1-3/4" standard, 2"-3" thick doors available as special order |
| BACKSET: | • 2-3/4" |
| CASE: | • 12-gauge cold rolled steel mechanism • Dichromated for corrosion resistance • Features weakened spindle design to prevent case damage |
| ARMOR FRONT: | • Beveled 1/8" on 2" • 625 (US26) & 630 (US32D) use stainless steel as base material, all other finishes use stainless steel or brass as base material |
| STRIKE: | • Non-handed Curved Lip Strike • 625 (US26) & 630 (US32D) use stainless steel as base material, all other finishes use stainless steel or brass as base material |
| LEVERS: | • F Series Sectional/Escutcheon: Philadelphia, Boston, Miami • J Series Sectional/Escutcheon: Philadelphia, Boston, Miami, Chicago, Dallas, Houston, Los Angeles, Memphis, Orlando, Ball Knob |
| LATCHBOLT: | • 3/4" Throw • Investment Cast Stainless Steel • Anti-friction |
| DEADBOLT: | • 1" Throw • Investment Cast Stainless Steel |
| HAND: | • Most functions field reversible. Specify handing for Strikes, consult factory for details |
| TRIM: | • F trim - forged brass levers and escutcheons • Round and square rose available • J Trim - stainless steel sectional/escutcheon trim and levers, PHL, MEM, MIA and BSN are solid levers LAX, ORL, DAL and CHI are tube levers |
| KEYS: | • Two (2) per Lock |
| KEYWAYS: | • SCC standard (Schlage C Compatible) • Also available in keyways of other manufacturers |
| INTERCHANGEABLE CORE: | • 6 or 7-pin • Compatible with Best, Falcon & Arrow • Large Format IC Cores compatible with Schlage. |
| CYLINDER: | • 6 or 7-pin Brass Mortise Cylinder • Standard High Security and UL437 Cylinders Available |
| KEYING: | • Options: MK, CMK or GMK • Zero Bitted (KO), Keyed Different (KD) or Keyed Alike (KA) Can be keyed into existing master key systems |
| FINISHES: | • F Series Trim: 626 (US26D) • J Trim: 605 (US3), 606 (US4), 612 (US10), 613E, 622 (US19), 629 (US32), 630 (US32D) • Antimicrobial Coating available on 626 (US26D) & 630 (US32D) for F and J Trim. |
| PERFORMANCE: | • Tested to over 11 million cycles, 11X ANSI/BHMA standard |
| CERTIFICATIONS, LISTINGS, COMPLIANCES: | • UL listed for 3 hrs, for single doors up to 4'0" x 8'0" • Certified to ANSI/BHMA 156.13 Operational Grade 1 and Security Grade 1 • Approved for Florida HVHZ (High Velocity Hurricane Zone). PDQ Product Approval: FL 21376. Design load rating: ± 70.0 PSF for single door (3' x 7') • Complies with ADA (Americans with Disabilities Act) and ICC/ANSI 117.1 for Accessible and Usable Buildings • J Wide Escutcheon Trim complies with Unified Facilities Guide Specification 08 71 00 (August 2008) |
| WARRANTY: | • Lifetime Limited Warranty |
| COUNTRY OF ORIGIN: | • Assembled in the U.S.A. with U.S. and foreign material. Meets requirements of the Buy American Act as a COTS product manufactured in the United States. |

Note: Heavy Duty Spindle for High Abuse situations is available for F trim.

‡ Available with antimicrobial coating, technology that is known to inhibit the growth of microbes.

How to Order

| SERIES | FUNCTION | LEVER | TRIM | FINISH | HANDING ¹ | DOOR THICKNESS | CYLINDER | KEYWAY OR HOUSING | KEYING | OPTIONS |
|--------|----------|---------------|-----------------------------|--------|-----------------------|----------------|---|-------------------|--------|------------------------------------|
| MR | 136 | PF | EF | 626 | RH | 134 | D | SCC | KD | — |
| | PAGE 12 | F-TRIM | F-TRIM | 605 | RH — | 134 — 1-3/4" | D Default | PAGE 14 | | REX — |
| | | PF — | EF — | 606 | Right Hand | 214 — 2-1/4" | L Less Cylinder | | | Request |
| | | PHL | Escutch- eon | 612 | (Default) | | SF6 Lock is SFIC prepped w/ 6 pin core | | | (Functions |
| | | BF — | Sectional | 613E | RHR — | | SF7 Lock is SFIC prepped w/ 7 pin core | | | 199A and |
| | | BSN | Rose | 622 | Right Hand Reverse | | SFL Lock is SFIC prepped but less core | | | 200only). |
| | | MIA | Sectional Rose | 626 | LH — | | SFC Lock is SFIC prepped w/ construction core | | | AM — |
| | | | | 630 | Left Hand | | SFP Lock is SFIC prepped w/ plastic construction core | | | Antimicrobi- al Coating. |
| | | J-TRIM | J-TRIM | | LHR — | | LF6 Lock is Schlage LFIC | | | LL — |
| | | PJ — | EJ — | | Left Hand Reverse | | LFL Lock is Schlage LFIC prepped but less core | | | Lead Wrapped Case. |
| | | PHL | Standard Escutch- eon | | | | LFC Lock is Schlage LFIC prepped w/ construction core | | | ADA — |
| | | BJ — | Wide Escutch- eon | | | | | | | Disability Turn. |
| | | BSN | Sectional Round Rose | | | | | | | Additional options available |
| | | MJ — | SJ — | | | | | | | |
| | | MIA | Sectional Round Rose | | | | | | | |
| | | CH | Sectional Square Rose | | | | | | | |
| | | DAL | Sectional Square Rose | | | | | | | |
| | | HJ — | Sectional Square Rose | | | | | | | |
| | | HOU | Sectional Square Rose | | | | | | | |
| | | LJ — LA | Sectional Square Rose | | | | | | | |
| | | TJ — | Sectional Square Rose | | | | | | | |
| | | MEM | Sectional Square Rose | | | | | | | |
| | | OJ — | Sectional Square Rose | | | | | | | |
| | | ORL | Sectional Square Rose | | | | | | | |
| | | KJ —K | Sectional Square Rose | | | | | | | |

- NOTES:**
- 1 - Specify handing for all functions
 - 2 - For Split Finishes, Contact PDQ Customer Service
 - 3 - Compatible with all F, J and JW Series trim, any Sectional or Escutcheon.

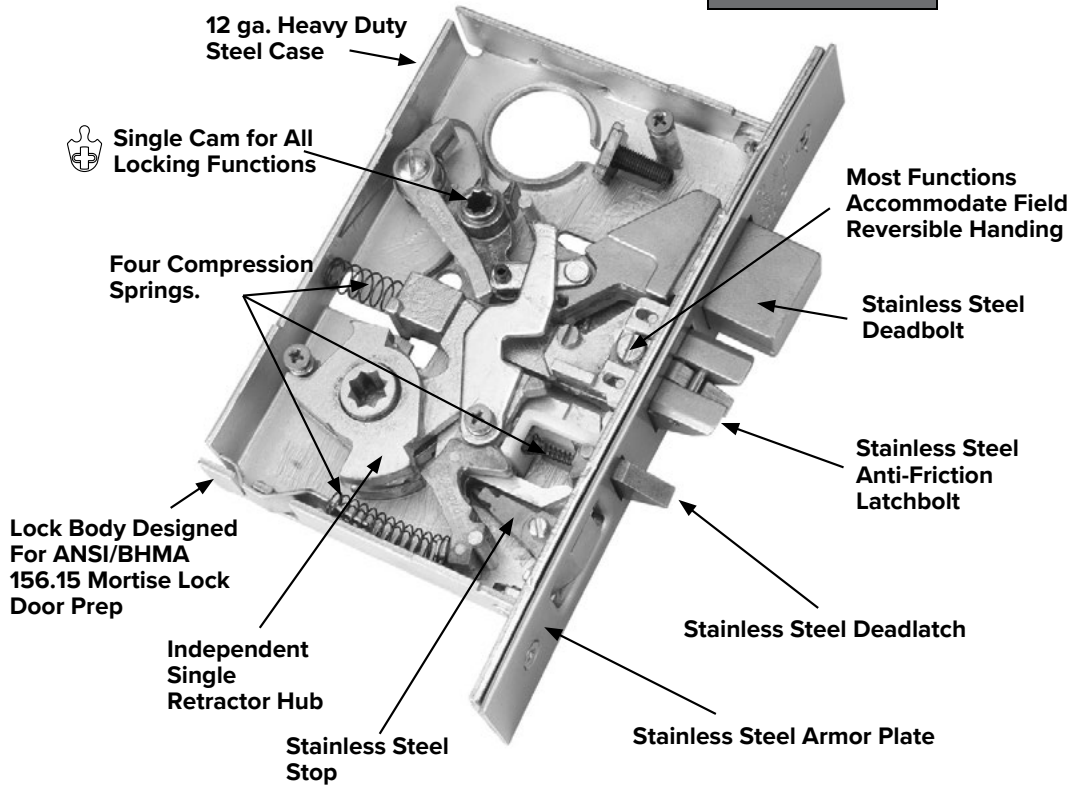

MR SERIES



LIST PRICE

Effective July 3, 2023

Locksets/Trim

Notes:

- 1 - Lock adjustment for Square Rose, Wide J Trim, see page 13.
- 2 - Finishes 605, 606 and 612 consult factory for lead-time.
- 3 - F-Trim available in 626 only.

| SECTIONAL | | | ESCUTCHEON | | |
|--|---------------|---------------------------|---|---|--|
|  | | |  | | |
| SERIES: | F SERIES | J SERIES | F SERIES | J SERIES | |
| LEVERS: | PHL, BSN, MIA | ALL LEVERS & KNOB | PHL, BSN, MIA | ALL LEVERS & KNOB | |
| ROSE/ESCUTCHEON: | ROUND (SF) | ROUND (SJ) SQUARE (SR) | (EF) 2-1/16" W x 7-5/8" H | STANDARD (EJ): 1-3/4" W x 7-5/8" H WIDE (EW): 2-9/16" W x 8" H | |

| | ANSI NO. | FUNCTION | DESCRIPTION | 626 | 630 | 605, 606, 612, 613E, 622, 629 | 626 | 630 | 605, 606, 612, 613E, 622, 629 |
|-------------------------------|----------|--|--|-----------|-----------|-------------------------------|-----------|-----------|-------------------------------|
| NON-KEYED | F01 | 126 | Passage | \$550.00 | \$520.00 | \$570.00 | \$580.00 | \$550.00 | \$610.00 |
| | | 174 | Privacy with Thumbturn Both Sides | \$630.00 | \$600.00 | \$650.00 | \$660.00 | \$630.00 | \$690.00 |
| | F22 | 176 | Privacy | | | | | | |
| SINGLE CYLINDER | F06 | 113 | Classroom Hold back Single Cyl | | | | | | |
| | F07 | 115 | Storeroom | | | | | | |
| | F04 | 116 | Entry | \$660.00 | \$630.00 | \$680.00 | \$690.00 | \$660.00 | \$720.00 |
| | F05 | 148 | Classroom | | | | | | |
| | | 149 | Assisted Living | | | | | | |
| | | 181 | Office | | | | | | |
| DOUBLE CYLINDER | | 114 | Classroom Hold back Double Cyl | | | | | | |
| | F30 | 138 | Institution | \$730.00 | \$700.00 | \$750.00 | \$760.00 | \$730.00 | \$790.00 |
| | F09 | 186 | Apartment Entrance | | | | | | |
| NON-KEYED WITH DEADBOLT | F02 | 178 | Privacy with Deadbolt | \$700.00 | \$670.00 | \$720.00 | \$730.00 | \$700.00 | \$760.00 |
| | F19 | 179 | Privacy with Deadbolt and Egress | | | | | | |
| SINGLE CYLINDER WITH DEADBOLT | F08 | 117 | Front Door | | | | | | |
| | F21 | 135 | Entrance, Storeroom | | | | | | |
| | F13 | 136 | Dormitory, Entrance | | | | | | |
| | | 139 | Closet, Storeroom | \$685.00 | \$655.00 | \$705.00 | \$715.00 | \$685.00 | \$745.00 |
| | | 141 | Storeroom with Deadbolt | | | | | | |
| | F10 | 154 | Entrance | | | | | | |
| | F20 | 162 | Apartment, Corridor | | | | | | |
| | | 213 | Double Cylinder and Thumbturn Deadbolt with Dummy Trim | \$660.00 | \$630.00 | \$680.00 | \$690.00 | \$660.00 | \$720.00 |
| | 215 | Single Cylinder Deadbolt with Dummy Trim | \$650.00 | \$620.00 | \$670.00 | \$680.00 | \$650.00 | \$710.00 | |
| DOUBLE CYLINDER WITH DEADBOLT | | 128 | Institution with Deadbolt | | | | | | |
| | F14 | 137 | Store Door | | | | | | |
| | F34 | 157 | Intruder Deadbolt with Deadlatch | | | | | | |
| | F11 | 158 | Dormitory | \$750.00 | \$720.00 | \$770.00 | \$780.00 | \$750.00 | \$810.00 |
| | F33 | 159 | Dormitory | | | | | | |
| | 214 | Double Cylinder and Thumbturn Deadbolt with Dummy Trim | | | | | | | |
| DEADLOCK | F18 | 131 | Single Cylinder Deadbolt | \$420.00 | \$390.00 | \$440.00 | | | |
| | F17 | 132 | Cylinder and Thumbturn Deadbolt | | | | | | |
| | F16 | 133 | Double Cylinder Deadbolt | \$430.00 | \$400.00 | \$450.00 | | | |
| | F29 | 134 | Classroom Deadbolt | | | | | | |
| ELECTRIFIED | | 199A | Storeroom, Single Cylinder | \$1030.00 | \$1000.00 | \$1050.00 | \$1060.00 | \$1030.00 | \$1090.00 |
| | | 200 | Institutional, Double Cylinder | \$1060.00 | \$1030.00 | \$1080.00 | \$1090.00 | \$1060.00 | \$1120.00 |
| WITH INDICATORS | — | 232 | Privacy Single Cylinder Deadbolt w/Indicator | | | | | | |
| | F13 | 236 | Dormitory, Entrance w/Indicator | | | | | | |
| | | 241 | Storeroom with Deadbolt w/Indicator | | | | | | |
| | F34* | 257 | Intruder w/Indicator | | | | | | |
| | F33* | 259 | Dormitory w/Indicator | | | | | | |
| | F15* | 260 | Faculty Restroom w/Deadbolt w/Indicator | | | | | | |
| | | 269 | Privacy w/Indicator | | | | | | |
| | F22* | 276 | Privacy w/Indicator | | | | | | |
| | F02* | 278 | Privacy w/Deadbolt w/Indicator | | | | | | |
| | F19* | 279 | Privacy w/Deadbolt and Egress w/Indicator | | | | | | |
| DUMMY/ DUMMY TRIM | | 205 | Double Dummy | \$390.00 | \$360.00 | \$410.00 | \$420.00 | \$390.00 | \$450.00 |
| | | 206 | Double Dummy with Chassis | \$490.00 | \$460.00 | \$510.00 | \$520.00 | \$490.00 | \$550.00 |
| | | 207 | Double Dummy with Active Trim | | | | | | |
| | | 211 | Single Dummy | \$210.00 | \$180.00 | \$205.00 | \$240.00 | \$210.00 | \$240.00 |
| | | 212 | Single Dummy with Chassis | \$310.00 | \$280.00 | \$330.00 | \$340.00 | \$310.00 | \$370.00 |

*w/Indicator

J Series Rose and Escutcheon Lock Adjustment

| CODE | DESCRIPTION | LOCK ADJUSTMENT |
|------|--|---|
| | | 630, 605, 606, 612, 613E, 622, 629 |
| SR | Sectional Square Rose - J Trim | \$20.00 |
| EJ | Standard Width Escutcheon - J Trim Dimensions: 1-3/4" W x 7-5/8" H | N/C |
| EW | Wide Width Escutcheon - J Trim Dimensions: 2-9/16" W x 8" H | \$10.00 (Additional add to EJ List Price) |
| SJ | Sectional Round Rose - J Trim | N/C |

F Type Levers



PHILADELPHIA — PF



BOSTON — BF



MIAMI — MF

J Type Levers



PHILADELPHIA — PJ



BOSTON — BJ



MIAMI — MJ



CHICAGO — CJ



DALLAS — DJ



HOUSTON — HJ



MEMPHIS — TJ



ORLANDO — OJ

(Specify handing)



LOS ANGELES — LJ



BALL KNOB — KJ*



ALL LEVERS

*Knobs are not ADA Compliant

| CYLINDER OPTIONS | ICON |
|------------------|------|
| D | |
| SFL | |
| LFL | |

IC Core not included see page 15 for core options

Sectional Trim



ROUND ROSE (SF)
F-TRIM



SQUARE ROSE (SR)
J-TRIM ONLY



ROUND ROSE (SJ)
J-TRIM

Escutcheon Trim



EF
STANDARD F



EJ
STANDARD J



EW
WIDE J

MR SERIES

LIST PRICE

Effective July 3, 2023

| PDQ KEYWAY | COMPATIBLE WITH | SOLD WITH LOCK |
|--|---|----------------|
| AR1 | Arrow / AR1 | N/C |
| CO59A1 | Corbin / 59A1 | |
| CO6 | Corbin / 60 | |
| CL4 | Corbin / L4 | |
| RUD | Ruswin / D1 | |
| SCE | Schlage / E | |
| SCC | Schlage / C | |
| SCC-K | Schlage / C-K | |
| SAL | Sargent / LA | |
| RA-RC | Sargent / RA-RC | |
| YA8 | Yale / E1R | |
| GA | Yale / GA | |
| FAL | Falcon / E-R | |
| KW | Kwikset | |
| TA | PDQ / TA (Restricted. Limited to Grandmaster systems w/4 masters) | |
| Dummy | — | |
| T-Turn | — | |
| L | Less Cylinder | |
| HIGH SECURITY CYLINDERS AND CORES | | |
| SEE HIGH SECURITY CYLINDERS AND CORES SECTION, PAGE 118. | | |

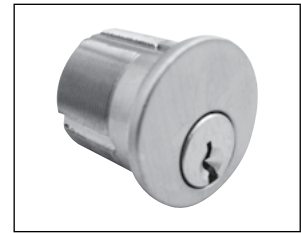

Mortise Cylinder

NOTES:

- Uncombined cores do not include springs & pins
- Combined cores include master keying in the list price
- **PDQ1, PDQ2, PDQ3 (Restricted)**
BEST A2 & A4 Systems Available
- Control Keys must be ordered separately

Cores and Keyways

| DESCRIPTION | PDQ NO. | ADD |
|--|------------------|---------|
| SMALL FORMAT UNCOMBINED | | |
| 6 Pin Cores | I5206 + KEYWAY | \$40.00 |
| 7 Pin Cores | I5207 + KEYWAY | |
| COMBINATED | | |
| 6 Pin Cores | I5206-1 + KEYWAY | \$60.00 |
| 7 Pin Cores | I5207-1 + KEYWAY | |
| BEST Compatible | | |
| A (DEFAULT), B, C, D, E, F, G, H, J, K, L, M, Q, | | |
| WA, WB, WC, WG, WH, TB, TD, TE, & R | | |
| PDQ Exclusive | | |
| PDQ1, PDQ2 | | |
| PDQ Exclusive and Restricted | | |
| PDQ3 | | |
| SFIC CONSTRUCTION | | |
| Construction Core 6-pin only | | \$60.00 |
| Dummy Construction Core Plastic | | \$8.00 |
| LFIC CONSTRUCTION | | |
| Construction Core 6-pin only. Construction cores are invoiced at shipment and credited upon return. | | \$70.00 |
| IC Tailpiece Assembly | | \$10.00 |
| LFIC COMBINATED | | |
| Schlage compatible LFIC, SCC (Schlage C compatible) keyway | | \$70.00 |
| PDQ TA LFIC Restricted | | |
| LFIC UNCOMBINED | | |
| Schlage compatible LFIC, SCC (Schlage C compatible) keyway | | \$50.00 |
| HIGH SECURITY IC CORES | | |

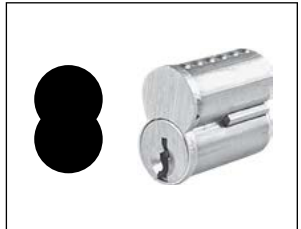

SFL/SFIC Core

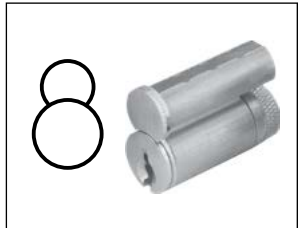

LFL/LFIC Schlage Format



IC Mortise Housing

Options

| CODE | DESCRIPTION | LOCK ADJUSTMENT |
|-------|--|---------------------|
| TC1IS | Tactile Abrasive Coating - Inside only (PHL and MIA levers only) | \$25.00 |
| TC1OS | Tactile Abrasive Coating - Outside only (PHL and MIA levers only) | |
| TC2 | Tactile Abrasive Strip - Both Sides (PHL and MIA levers only) | \$50.00 |
| SSM | Sectional Single Sided Mounting Assembly | |
| LL | Lead-wrapped Case | \$185.00 |
| SHS | Security Head Screws | \$15.00 |
| EASA | Extended Lip Strike (1-3/8, 1-5/8, 1-7/8) | \$10.00 |
| REX | Request to Exit (Available for functions 199A and 200 only) | \$185.00 |
| LM | Latch Bolt Monitoring | |
| SF | Split Finishes | Higher Finish Price |
| HDS | HD Spindle for high abuse applications (for F Trim Only) | \$35.00 |
| AM | Antimicrobial Coating - Sectional Mortise Lock inside lever, rose, thumbturn, outside lever (Not available with 605 finish) | |
| AM | Antimicrobial Coating - Escutcheon Mortise Lock inside lever, rose, thumbturn, outside lever (Not available with 605 finish) | |
| ADA | Disability Turn (ADA) - for J Trim Only | \$10.00 |
| TD1 | MR adapted to accommodate 2-1/4"-2-1/2" thick door | \$65.00 |
| TD2 | MR adapted to accommodate 2-3/4" thick door | |
| TD3 | MR adapted to accommodate 3" thick door | |



Thick Door Installation Kits

| DESCRIPTION | PDQ NO. | LIST PRICE |
|--|---------|------------|
| J TRIM SECTIONAL | | \$150.00 |
| 2-1/2" door | W51447 | |
| 2-3/4" to 3" door | W51448 | |
| J TRIM ESCUTCHEON AND ESCUTCHEON WIDE | | |
| 2-1/2 -2-3/4" door | W51449 | |
| 3" door | W51450 | |

Note: Kits include hardware to install lock in center of door. Cylinders and strikes not included.

Strikes

| DESCRIPTION | LIP LENGTH | PDQ NO. | LIST PRICE |
|--|------------|---------------------------|------------|
| 1-1/4" x 4-7/8" ANSI/ASA Curved Lip (NON-HANDED) | 1-3/16" | W51290-(designate finish) | \$30.00 |
| Extended Straight Lip | 1-7/8" | W51002-(designate finish) | \$40.00 |

Mortise Lock Body with Armor Plate

| TYPE | LOCK BODY BY FUNCTION | PDQ NO. | LIST PRICE |
|--------------------------|---|--------------------------|------------|
| Non-Keyed | 126, 174, 176 | Contact Customer Support | \$265 |
| Non-Keyed Deadbolt | 178, 179 | | \$290 |
| Single Cylinder | 113, 115, 116, 148, 149, 181 | | \$300 |
| Single Cylinder Deadbolt | 117, 135, 136, 139, 141, 154, 162, 213, 215 | | \$330 |
| Double Cylinder | 114, 138, 186 | | \$300 |
| Double Cylinder Deadbolt | 128, 137, 157, 158, 159, 214 | | \$330 |
| Electrified | 199A / 200 | | \$500 |
| Electrified w/ REX | 199A / 200 REX | | \$550 |

Sectional Trim Packs* (Lever and Rose)

| DESCRIPTION | PDQ NO. | LIST PRICE |
|--|--------------------------|------------|
| Full Sectional Trim Pack (both sides of door), "F" or "J" Trim, All Functions* | Contact Customer Support | \$400.00 |
| Half Sectional Trim Pack (one side of door), "F" or "J" Trim, All Functions* | | \$200.00 |

* Note - Cylinders priced separate, See cylinders page 130

Escutcheon Trim Packs* (Lever and Escutcheon)



| DESCRIPTION | PDQ NO. | LIST PRICE |
|---|--------------------------|------------|
| Full Escutcheon Trim Pack (both sides of door), "F" or "J" Trim, All Functions* | Contact Customer Support | \$450.00 |
| Half Escutcheon Trim Pack (one side of door), "F" or "J" Trim, All Functions* | | \$225.00 |

* Note - Cylinders priced separate, See cylinders page 130





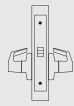
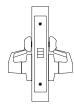

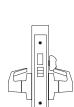
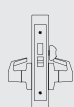
Miscellaneous Parts

| DESCRIPTION | PDQ NO. | LIST PRICE |
|---|---------------|------------|
| Cam (Corbin A01) For #16 mortise Cylinder | I127-4201 | \$10.00 |
| IC Cam for SFIC Mortise Housing | I54061 | |
| IC Cam for LFIC Mortise housing | I54261 | |
| Collar Cyl Vandal 3/8" (specify finish) | W51214 | \$20.00 |
| Collar Spring | W51049 | \$8.00 |
| Anti-Friction Latchbolt | W91904 | \$40.00 |
| 1-3/8" Extended Straight Lip | W51002-1-3/8" | |
| 1-3/4" Extended Straight Lip | W51002-1-5/8" | |

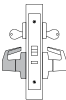

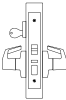

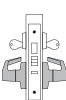
PDQ Functions – Non Keyed

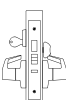
| FUNCTION | FUNCTION NUMBER | OUTSIDE INSIDE | DESCRIPTION | ANSI NUMBER |
|--------------------------------------|-----------------|---|--|-------------|
| Passage | MR126 |  | <ul style="list-style-type: none"> Latchbolt operated by lever from either side | F01 |
| Privacy with Thumbturn on Both Sides | MR174 |  | <ul style="list-style-type: none"> Latchbolt operated by lever from either side Thumbturn outside locks/unlocks outside lever Thumbturn inside locks/unlocks outside lever Closing door unlocks outside lever Rotating inside lever unlocks outside lever | — |
| Privacy | MR176 |  | <ul style="list-style-type: none"> Latchbolt operated by lever from either side Emergency coin turn outside unlocks outside lever Thumbturn inside locks/unlocks outside lever Closing door unlocks outside lever Rotating inside lever unlocks outside lever | F22 |
| Privacy with Deadbolt | MR178 |  | <ul style="list-style-type: none"> Latchbolt operated by lever from either side Emergency coin turn outside retracts deadbolt Thumbturn inside extends/retracts deadbolt Not field reversible Specify handing | F02 |
| Privacy with Deadbolt and Egress | MR179 |  | <ul style="list-style-type: none"> Latchbolt operated by lever from either side Emergency coin turn outside retracts deadbolt Thumbturn inside extends/retracts deadbolt Inside lever simultaneously retracts latchbolt and deadbolt | F19 |



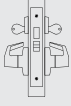
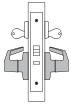
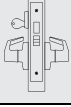
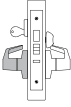

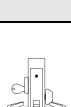
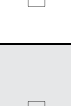
PDQ Functions – Keyed

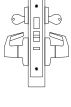
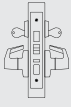
| FUNCTION | FUNCTION NUMBER | OUTSIDE INSIDE | DESCRIPTION | ANSI NUMBER |
|---------------------------|-----------------|---|---|-------------|
| Hold Back Single Cylinder | MR113 |  | <ul style="list-style-type: none"> Latchbolt operated by lever from inside Key outside retracts latchbolt Rigid outside lever Auxiliary latch deadlocks latchbolt Key outside secures latchbolt when latchbolt is retracted by inside lever Not field reversible Specify handing | F06 |
| Hold Back Double Cylinder | MR114 |  | <ul style="list-style-type: none"> Latchbolt operated by lever from inside Key outside retracts latchbolt Rigid outside lever Auxiliary latch deadlocks latchbolt Key inside secures latchbolt when latchbolt is retracted by inside lever Not field reversible Specify handing | — |
| Storeroom | MR115 |  | <ul style="list-style-type: none"> Latchbolt operated by lever from inside Key outside retracts latchbolt Rigid outside lever Auxiliary latch deadlocks latchbolt | F07 |
| Entry | MR116 |  | <ul style="list-style-type: none"> Latchbolt operated by lever from either side Toggle locks/unlocks outside lever Key outside retracts latchbolt Auxiliary latch deadlocks latchbolt | F04 |
| Front Door | MR117 |  | <ul style="list-style-type: none"> Latchbolt operated by lever from either side Toggle locks/unlocks outside lever Key outside retracts latchbolt Key outside extends/retracts deadbolt Thumbturn inside extends/retracts deadbolt | F08 or F10 |
| Institution with Deadbolt | MR128 |  | <ul style="list-style-type: none"> Key outside retracts latchbolt Key inside retracts latchbolt Key outside extends/retracts deadbolt Key inside extends/retracts deadbolt Rigid outside lever Rigid inside lever Auxiliary latch deadlocks latchbolt | — |
| Entrance/Storeroom | MR135 |  | <ul style="list-style-type: none"> Latchbolt operated by lever from either side Key outside extends/retracts deadbolt Thumbturn inside extends/retracts deadbolt | F21 |
| Dormitory/Exit | MR136 |  | <ul style="list-style-type: none"> Latchbolt operated by lever from either side Key outside extends/retracts deadbolt Thumbturn inside extends/retracts deadbolt Inside lever simultaneously retracts latchbolt and deadbolt Auxiliary latch deadlocks latchbolt | F13 |

PDQ Functions – Keyed

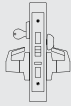
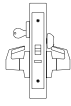
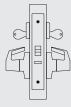
| FUNCTION | FUNCTION NUMBER | OUTSIDE INSIDE | DESCRIPTION | ANSI NUMBER |
|----------------------------------|-----------------|---|--|-------------|
| Store Door | MR137 |  | <ul style="list-style-type: none"> Latchbolt operated by lever from either side Key outside extends/retracts deadbolt Key inside extends/retracts deadbolt Latchbolt and deadbolt are independent of each other | F14 |
| Institution | MR138 |  | <ul style="list-style-type: none"> Key outside retracts latchbolt Key inside retracts latchbolt Rigid outside lever Rigid inside lever Auxiliary latch deadlocks latchbolt | F30 |
| Closet / Storeroom | MR139 |  | <ul style="list-style-type: none"> Latchbolt operated by lever from either side Key outside extends/retracts deadbolt | — |
| Storeroom with Deadbolt | MR141 |  | <ul style="list-style-type: none"> Latchbolt operated by lever from inside Key outside retracts latchbolt Key outside extends/retracts deadbolt Rigid outside lever Inside lever simultaneously retracts latchbolt and deadbolt Auxiliary latch deadlocks latchbolt Thumbturn inside extends/contracts deadbolt but doesn't effect outside lever. | — |
| Classroom | MR148 |  | <ul style="list-style-type: none"> Latchbolt operated by lever from either side Key outside retracts latchbolt Key outside locks/unlocks outside lever Inside lever always free Auxiliary latch deadlocks latchbolt  | — |
| Assisted Living | MR149 |  | <ul style="list-style-type: none"> Latchbolt operated by lever from either side Key outside locks/unlocks outside lever Thumbturn inside locks/unlocks outside lever Closing door unlocks outside lever Rotating inside lever unlocks outside lever Auxiliary latch deadlocks latchbolt | — |
| Entrance | MR154 |  | <ul style="list-style-type: none"> Latchbolt operated by lever from either side Toggle locks/unlocks outside lever Key outside retracts latchbolt Key outside extends/retracts deadbolt Thumbturn inside extends/retracts deadbolt Inside lever simultaneously retracts latchbolt and deadbolt Auxiliary latch deadlocks latchbolt Projecting then retracting the deadbolt releases the toggle | — |
| Intruder Deadbolt with Deadlatch | MR157 |  | <ul style="list-style-type: none"> Latchbolt operated by lever from either side Key outside extends/retracts deadbolt Key inside extends/retracts deadbolt Inside lever simultaneously retracts latchbolt and deadbolt Auxiliary latch deadlocks latchbolt  | F34 |
| Dormitory | MR158 |  | <ul style="list-style-type: none"> Latchbolt operated by lever from either side Toggle locks/unlocks outside lever Key outside extends/retracts deadbolt Key inside extends/retracts deadbolt Inside lever simultaneously retracts latchbolt and deadbolt Auxiliary latch deadlocks latchbolt | F11 |
| Dormitory | MR159 |  | <ul style="list-style-type: none"> Latchbolt operated by lever from either side Key outside extends/retracts deadbolt Key inside extends/retracts deadbolt Inside lever simultaneously retracts latchbolt and deadbolt | F33 |

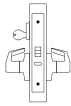
PDQ Functions – Keyed

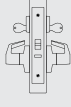
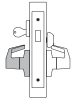
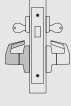
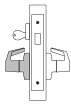
| FUNCTION | FUNCTION NUMBER | OUTSIDE INSIDE | DESCRIPTION | ANSI NUMBER |
|--|--|---|--|-------------|
| Apartment/ Corridor | MR162 |  | <ul style="list-style-type: none"> Latchbolt operated by lever from either side Toggle locks/unlocks outside lever Key outside retracts latchbolt Key outside extends/retracts deadbolt Thumbturn inside extends/retracts deadbolt Inside lever simultaneously retracts latchbolt and deadbolt Auxiliary latch deadlocks latchbolt | F20 |
| Office | MR181 |  | <ul style="list-style-type: none"> Latchbolt operated by lever from either side Key outside locks/unlocks outside lever Thumbturn inside locks/unlocks outside lever Closing door unlocks outside lever Rotating inside lever unlocks outside lever Auxiliary latch deadlocks latchbolt | — |
| Apartment | MR186 |  | <ul style="list-style-type: none"> Latchbolt operated by lever from either side Key inside locks/unlocks outside lever Key outside retracts latchbolt Auxiliary latch deadlocks latchbolt Not Field Reversible | F09 |
| Electrified Storeroom |  MR199A |  | <ul style="list-style-type: none"> Key outside retracts latchbolt Latchbolt operated by lever from inside Auxiliary latch deadlocks latchbolt Fail safe – latchbolt operated by lever from outside unless electrically locked Fail secure – latchbolt operated by lever from outside when electrically unlocked Motor drive locking/unlocking Not field reversible Specify handing | — |
| Electrified Institutional |  MR200 |  | <ul style="list-style-type: none"> Key outside retracts latchbolt Key inside retracts latchbolt Auxiliary latch deadlocks latchbolt Fail safe – latchbolt operated by either lever when electrically locked Fail secure – latchbolt operated by either lever when electrically unlocked Motor drive locking/unlocking Not field reversible Specify handing | — |
| Cylinder and Thumbturn Deadbolt with Dummy Trim | MR213 |  | <ul style="list-style-type: none"> Key outside extends/retracts deadbolt Thumbturn inside extends/retracts deadbolt Rigid outside lever Rotating inside lever retracts deadbolt | — |
| Double Cylinder Deadbolt with Dummy Trim | MR214 |  | <ul style="list-style-type: none"> Key outside extends/retracts deadbolt Key inside extends/retracts deadbolt Rigid outside lever Rotating inside lever retracts deadbolt | — |
| Single Cylinder Deadbolt with Dummy Trim | MR215 |  | <ul style="list-style-type: none"> Key outside extends/retracts deadbolt Rigid outside lever Rotating inside lever retracts deadbolt | — |

 • Available with option:
REX - Request to Exit

 • Available with option:
REX - Request to Exit

MR SERIES

LIST PRICE

Effective July 3, 2023

PDQ Indicator Functions

- Locked/Unlocked Indicator conforms with ANSI Z535.1 Safety Colors: Red and Green.









Shown with optional Security Screws. For more information, contact PDQ Customer Service.





| FUNCTION | FUNCTION NUMBER | OUTSIDE INSIDE | DESCRIPTION | ANSI NUMBER |
|--|-----------------|------------------|--|-----------------|
| Dormitory/ Exit w/Indicator | MR236 | | <ul style="list-style-type: none"> • Latchbolt operated by lever from either side • Key outside extends/retracts deadbolt • Thumbturn inside extends/retracts deadbolt • Inside lever simultaneously retracts latchbolt and deadbolt • Auxiliary latch deadlocks latchbolt • Indicator, outside — (LOCKED/UNLOCKED) | F13 |
| Storeroom with Deadbolt w/Indicator | MR241 | | <ul style="list-style-type: none"> • Latchbolt operated by lever from inside • Key outside retracts latchbolt • Key outside extends/retracts deadbolt • Rigid outside lever • Inside lever simultaneously retracts latchbolt and deadbolt • Auxiliary latch deadlocks latchbolt • Thumbturn inside extends/contracts deadbolt but doesn't effect outside lever. • Indicator, outside — (LOCKED/UNLOCKED) | — |
| Intruder Deadbolt with Deadlatch | MR257 | | <ul style="list-style-type: none"> • Latchbolt operated by lever from either side • Key outside extends/retracts deadbolt • Key inside extends/retracts deadbolt • Inside lever simultaneously retracts latchbolt and deadbolt • Auxiliary latch deadlocks latchbolt • Indicator, inside — (LOCKED/UNLOCKED) | F34 w/Indicator |
| Intruder Deadbolt | MR259 | | <ul style="list-style-type: none"> • Latchbolt operated by lever from either side • Key outside extends/retracts deadbolt • Key inside extends/retracts deadbolt • Inside lever simultaneously retracts latchbolt and deadbolt • Indicator, inside — (VACANT/OCCUPIED) | F33 w/Indicator |
| Faculty Restroom with Deadbolt w/Indicator | MR260 | | <ul style="list-style-type: none"> • Latchbolt retracted by key outside or lever inside • Key outside extends/retracts deadbolt • Rigid outside lever • Thumbturn inside extends/retracts deadbolt • Rotating inside lever retracts deadbolt and latchbolt simultaneously • Inside lever is always free for immediate egress • Indicator, outside — (VACANT/OCCUPIED) | — |
| Privacy w/Indicator | MR 269 | | <ul style="list-style-type: none"> • Latchbolt operated by lever from either side • Key outside extends/retracts deadbolt • Thumbturn inside extends/retracts deadbolt • Inside lever simultaneously retracts latchbolt and deadbolt • Indicator, outside — (VACANT/OCCUPIED) | |
| Privacy w/Indicator | MR276 | | <ul style="list-style-type: none"> • Latchbolt operated by lever from either side • Emergency coin turn outside unlocks outside lever • Thumbturn inside locks/unlocks outside lever • Closing door unlocks outside lever • Rotating inside lever unlocks outside lever • Indicator, outside — (VACANT/OCCUPIED) | F22 w/Indicator |
| Privacy with Deadbolt w/Indicator | MR278 | | <ul style="list-style-type: none"> • Latchbolt operated by lever from either side • Emergency coin turn outside retracts deadbolt • Thumbturn inside extends/retracts deadbolt • Indicator, outside — (VACANT/OCCUPIED) | F02 w/Indicator |
| Privacy with Deadbolt and Egress w/Indicator | MR279 | | <ul style="list-style-type: none"> • Latchbolt operated by lever from either side • Emergency coin turn outside retracts deadbolt • Thumbturn inside extends/retracts deadbolt • Inside lever simultaneously retracts latchbolt and deadbolt • Indicator, outside — (VACANT/OCCUPIED) | F19 w/Indicator |

Notes: Functions MR257, MR259 and MR260 not available in 7 Pin SFIC or LFIC.

PDQ Functions – Deadlocks

| FUNCTION | FUNCTION NUMBER | OUTSIDE INSIDE | DESCRIPTION | ANSI NUMBER |
|--|-----------------|--|---|-------------|
| Single Cylinder Deadbolt | MR131 |  | <ul style="list-style-type: none"> • Key outside extends/retracts deadbolt | F18 |
| Cylinder and Thumbturn Deadbolt | MR132 |  | <ul style="list-style-type: none"> • Key outside extends/retracts deadbolt • Thumbturn inside extends/retracts deadbolt | F17 |
| Double Cylinder Deadbolt | MR133 |  | <ul style="list-style-type: none"> • Key outside extends/retracts deadbolt • Key inside extends/retracts deadbolt | F16 |
| Classroom Deadbolt | MR134 |  | <ul style="list-style-type: none"> • Key outside extends/retracts deadbolt • Inside cylinder turn retracts but does not extend deadbolt • Not field reversible • Specify handing  | F29 |
| Single Cylinder Deadbolt w/Indicator (Privacy) | MR232 |  | <ul style="list-style-type: none"> • Key outside extends/retracts deadbolt • Thumb turn inside extends/retracts deadbolt • Indicator outside displays: <ul style="list-style-type: none"> • Occupied when deadbolt is projected • Vacant when deadbolt is retracted • Indicator, outside — (VACANT/OCCUPIED) | — |

PDQ Functions – Non Keyed Dummy

| FUNCTION | FUNCTION NUMBER | OUTSIDE INSIDE | DESCRIPTION | ANSI NUMBER |
|-------------------------------|-----------------|---|---|-------------|
| Double Dummy | MR205 |  | <ul style="list-style-type: none"> • Rigid outside lever • Rigid inside lever | — |
| Double Dummy with Chassis | MR206 |  | <ul style="list-style-type: none"> • Rigid outside lever • Rigid inside lever | — |
| Double Dummy with Active Trim | MR207 |  | <ul style="list-style-type: none"> • Movable outside lever • Movable inside lever | — |
| Single Dummy | MR211 |  | <ul style="list-style-type: none"> • Rigid outside lever | — |
| Single Dummy with Chassis | MR212 |  | <ul style="list-style-type: none"> • Rigid outside lever | — |

Function Cross Reference

| ANSI # | PDQ FUNCTION | ARROW | BEST | CORBIN | DORMA | FALCON | MARKS | SARGENT | SCHLAGE | YALE |
|---------------|----------------|-------------|----------|-------------|-----------|--------|---------|---------|------------|--------------|
| DUMMY 1 SIDE | MR211 | BM/AM08 | 45H1DT | ML2050 | M9001 | MA12 | DI/DO | 8293 | L0170 | AU865 |
| DUMMY 2 SIDES | MR207 | BM/AM09 | 45H2DT | ML2071 | M9002 | MA18 | DT | 8294 | L0172 | AU838A |
| DUMMY 1 SIDE | MR212 | N/A | N/A | N/A | M9003 | N/A | N/A | N/A | L9175 | N/A |
| DUMMY 2 SIDES | MR206 | N/A | N/A | N/A | M9004 | N/A | N/A | N/A | L9176 | N/A |
| F01 | MR126 | BM/AM01 | 45HN | ML2071 | M9010 | MA101 | 5N | 8215 | L9010 | AU8801FL |
| F31 | SEE TJ SE-RIES | BM/AM07 | 45HNX | N/A | M9025 | MA161 | 5EX | N/A | N/A | AU8828 |
| F22 | MR176 | BM/AM26 | 45HLT | ML2060 | M9040 | MA321 | 5LJ | 8265 | L9040 | AU8862FL |
| F04 | MR116 | BM/AM22 | 45HA | ML2051 | M9050 | MA521 | 5E | 8205 | L9050 | AU8807FL |
| F09 | MR186 | BM/AM32 | 45HC | ML2042 | M9060 | MA381 | 5G | 8216 | L9060 | AU8817-2FL |
| F05 | MR148 | BM/AM17 | 45HR | ML2055 | M9070 | MA561 | 5J | 8237 | L9070 | AU8808FL |
| F06 | MR113 | N/A | 45HR/HB | ML2056 | M9076 | MA551 | 5JM/JR | 8289 | L9076 | AU8800 |
| F07 | MR115 | BM/AM12 | 45HD | ML2057 | M9080 | MA581 | 5EW | 8204 | L9080 | AU8805FL |
| | MR199A | BM/AM17/177 | 45HEL | ML22901 | M9080EL | MA851 | 5EL | 8270 | L9080EL | AU8890FL |
| | MR199A | BM/AM17/178 | 45HEU | ML22904 | M9080EU | MA881 | 5EU | 8270 | L9080EU | AU8891FL |
| | MR199A W/ REX | N/A | 45HEURQE | ML22901 M92 | M9080ELRX | N/A | 5EL W10 | RX-8272 | L9080ELRX | AU8890FL-REX |
| | MR199A W/ REX | N/A | 45HEURQE | ML22904 M92 | M9080ELRX | N/A | 5EU W10 | RX-8273 | L9080EU-RX | AU8891FL-REX |
| F30 | MR138 | BM/AM33 | 45HW | ML2032 | M9082 | MA411 | 5WW | N/A | L9082 | AU8830-2FL |
| F19 | MR179 | BM/AM02 | 45HL | ML2030 | M9940 | MA311 | 5LF | 8266 | L9440 | AU8802FL |
| F20 | MR162 | BM/AM20 | 45HAB | ML2067 | M9953 | MA531 | 5FD | 8243 | L9453 | AU8847FL |
| F13 | MR136 | BM/AM19 | 45HT | ML2065 | M9956 | MA571 | 5FW | 8225 | L9456 | AU8822FL |
| F11 | MR158 | N/A | N/A | N/A | M9957 | N/A | 5FA | N/A | N/A | AU8800 |
| F17 | MR132 | BM41 | 45HAD | ML2013 | N/A | M941 | 5P | 8221 | L9460 | AU8815 |
| F18 | MR131 | BM40 | 45HYB | NML2011 | N/A | MA921 | 5S | 8220 | L9464 | AU8814 |
| F16 | MR133 | BM42 | 45HWD | ML2012 | N/A | M931 | 5T | 8222 | L9462 | AU8814-2 |
| F29 | MR134 | BM44 | 45HRD | ML2017 | MB9963 | M911 | 5SC | 8203 | L9463 | AU8813ST |
| F14 | MR137 | BM/A/31 | 45HG | ML2017 | M9966 | MA371 | 5C | 8226 | L9466 | AU8860-2FL |
| F34 | MR157 | N/A | 45HIDA | ML2023 | M9967 | MA431 | 5FC | 8240 | N/A | AU8812-2FL |
| F33 | MR159 | N/A | 45HIND | N/A | M9968 | N/A | 5FX | N/A | L9457 | AU8811-2FL |
| F21 | MR135 | BM/AM13 | 45HB | ML2024 | M9973 | MA541 | 5B | 8224 | L9473 | AU8860FL |
| F02 | MR178 | N/A | N/A | ML2020 | N/A | MA301 | 5-55L | 8268 | N/A | N/A |

Lever Cross Reference

| LEVER AND KNOB OPTIONS | PDQ | ARROW | BEST | CORBIN | DORMA | FALCON | MARKS | SARGENT | SCHLAGE | YALE |
|------------------------|--------------|-------|------|--------------|-------|-----------|-------------------|---------|-------------|------------------|
| LEVER | PHILADELPHIA | X | 15 | NS NEWPORT | LR | D DANE | AMERICAN LEVER 92 | L | 06 RHODES | AU AUGUSTA |
| | BOSTON | BR | 14 | PS PRINCETON | LC | Q QUANTUM | CRESCENT LEVER 86 | P | 17SPARTA | PB PACIFIC BEACH |
| | CHICAGO | N | 12 | REGIS | LIIO | N/A | OMNI 78 | W | 02 | PINEHURST PNR |
| | DALLAS | HS | 3 | LS LUSTR | LT | K KIM | PLAZA LEVER 82 | J | 03TUBULAR | CR CARMEL |
| | HOUSTON | N/A | 79 | 25M PIET | N/A | N/A | N/A | REM | M51 | N/A |
| | MIAMI | V | 16 | AS ARMSTONG | LG | A AVALON | TITAN LEVER 96 | B | 07ATHENS | JN JEFFERSON |
| | MEMPHIS | W | 69 | DIRKE | LD | N/A | DAYTON 83 | A | 12 | VICTORIA TT |
| | LOS ANGELES | N/A | N/A | N/A | N/A | N/A | N/A | N/A | N/A | N/A |
| | ORLANDO | N/A | N/A | N/A | N/A | N/A | N/A | N/A | LATITUDE | N/A |
| KNOB | KNOB | HB | 4 | YW | KB | T TROY | ROUND KNOB 10 | C | 41 PLYMOUTH | LF LITCHFIELD |
| | B | HT | N/A | GR | KB | H HANA | ROUND KNOB 10 | B | 42 ORBIT | CA CAROLINA |
| | N/A | A | R | F | KB | G GALA | RW | N/A | B | R |

Information on this sheet is compiled from public documents and third parties. As a result, PDQ makes no guarantees as to their accuracy, content, quality or availability. Comparisons were made using the technical features only and are not commercial comparisons. Final suitability should be determined by a professional hardware consultant.



MR SERIES

LIST PRICE
Effective July 3, 2023

F Series Sectional Trim

- Levers: Solid Forged Brass
- Trim: Wrought

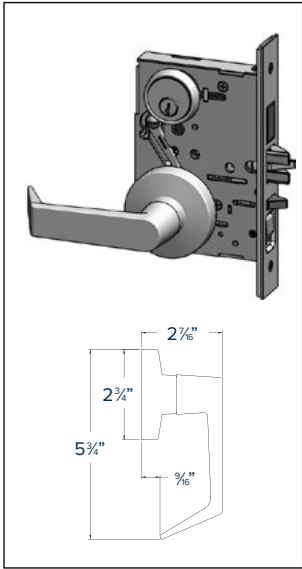

PHILADELPHIA — PFSF

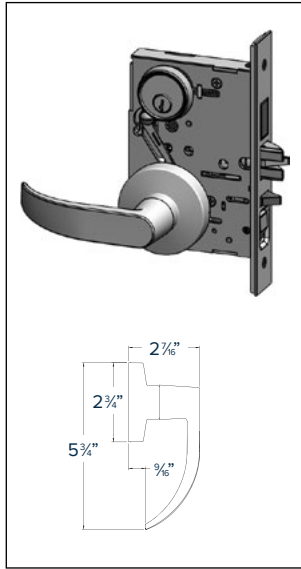

BOSTON — BFSF

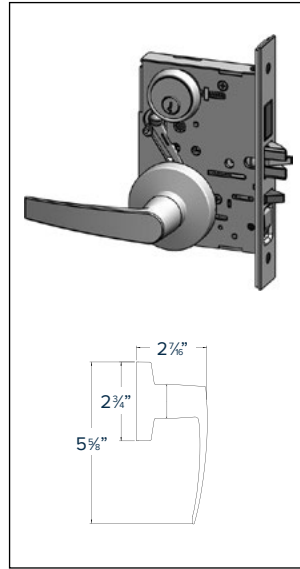

MIAMI — MFSF

F Series Escutcheon Trim

- Levers: Solid Forged Brass
- Trim: Forged Brass

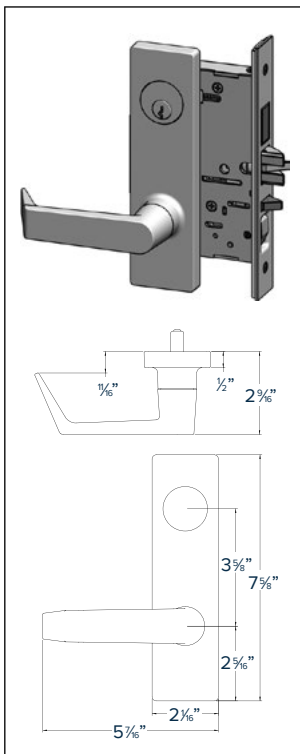

PHILADELPHIA — PFEF

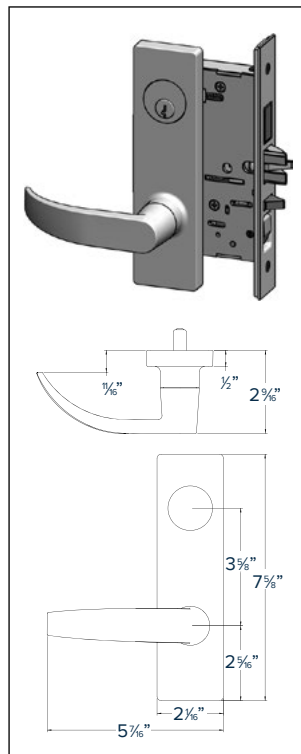

BOSTON — BFEF

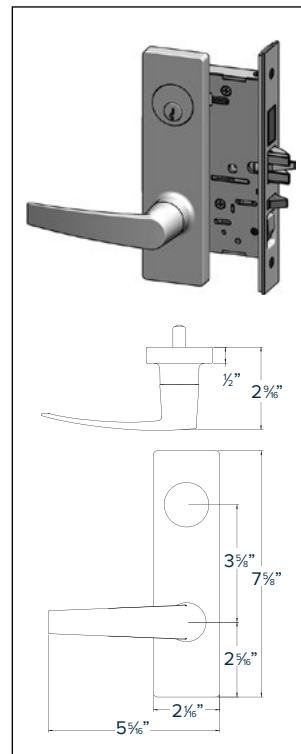

MIAMI — MFEF

ALL LEVERS

*Knobs are not ADA Compliant

J Series Sectional Trim with Round Rose

- Levers: Philadelphia, Boston, Miami, Memphis, Houston – Solid Levers
Chicago, Dallas, Los Angeles, Orlando – Hollow Tube Levers
- Trim: Wrought

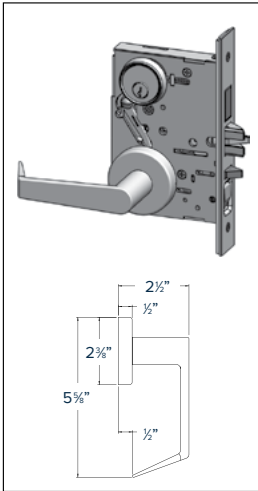

PHILADELPHIA — PJSJ

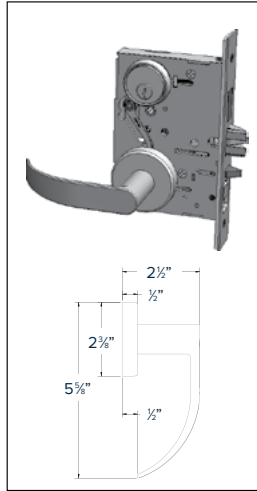

BOSTON — BJSJ

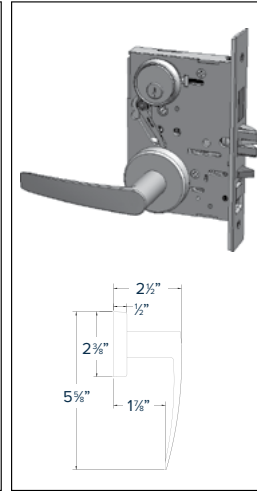

MIAMI — MJSJ

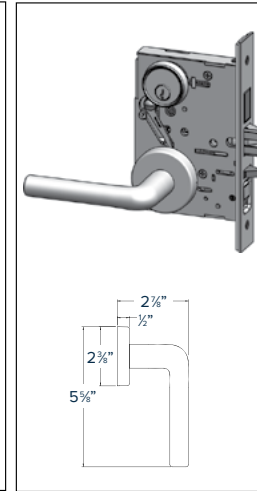

CHICAGO — CJSJ

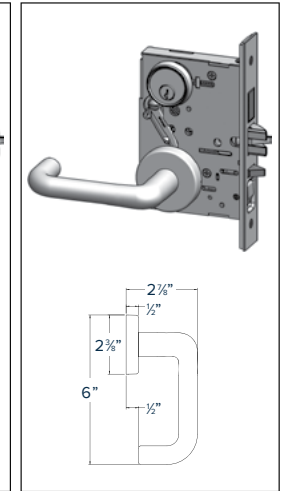

DALLAS — DJSJ

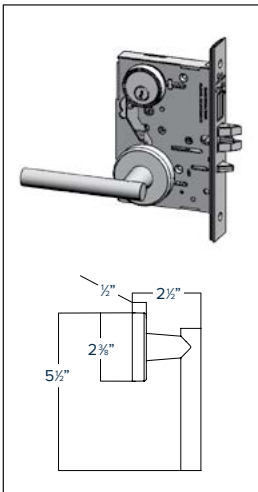

HOUSTON — HJSJ

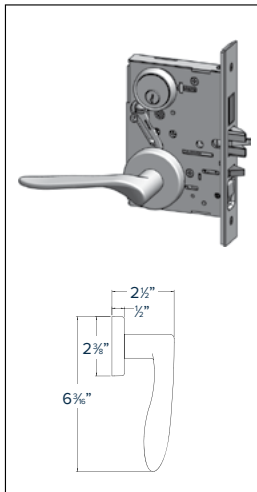

MEMPHIS — TJSJ

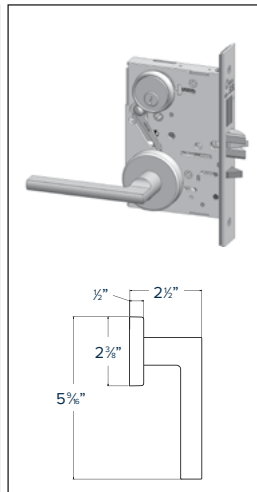

ORLANDO — OJSJ

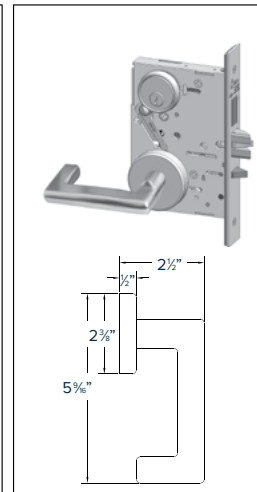

LOS ANGELES — LJSJ

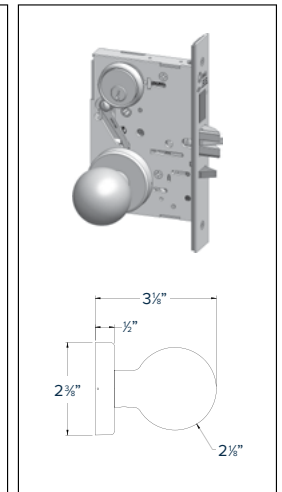

BALL KNOB — KJSJ



*Knobs are not ADA Compliant

MR SERIES

LIST PRICE

Effective July 3, 2023

J Series Sectional Trim with Square Rose

- Levers: Philadelphia, Boston, Miami, Memphis, Houston – Solid Levers
Chicago, Dallas, Los Angeles, Orlando – Hollow Tube Levers
- Trim: Wrought

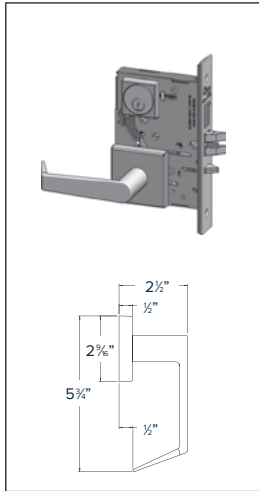

PHILADELPHIA — PJSR

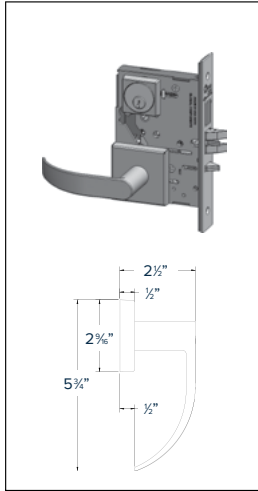

BOSTON — BJSR

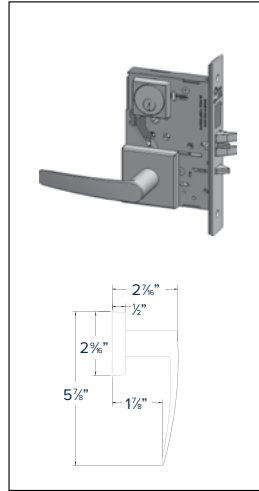

MIAMI — MJSR

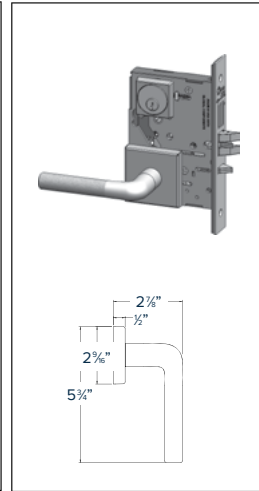

CHICAGO — CJSR

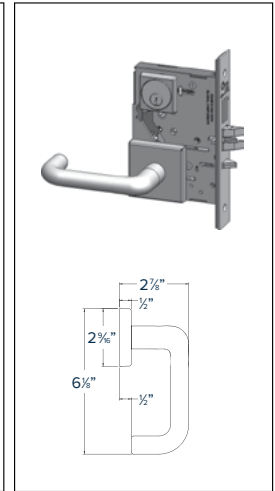

DALLAS — DJSR

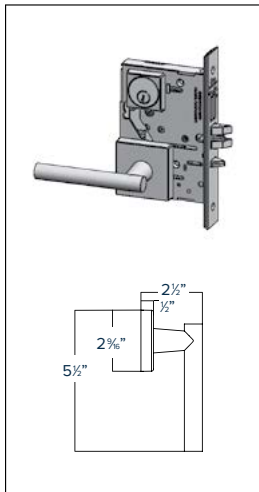

HOUSTON — HJSR

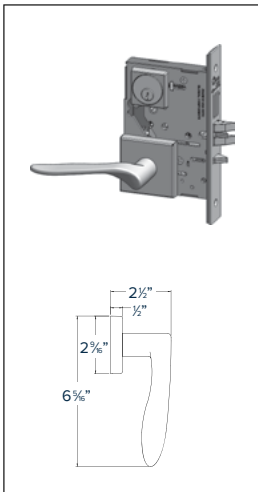

MEMPHIS — TJSR

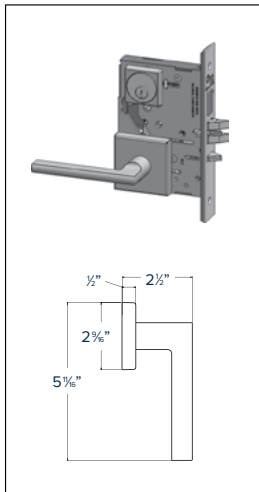

ORLANDO — OJSR

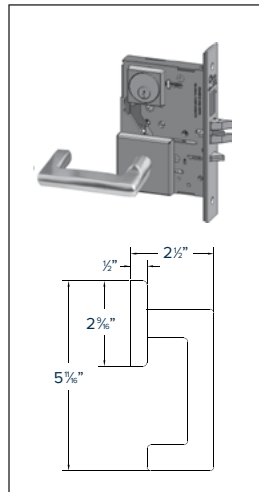

LOS ANGELES — LJSR

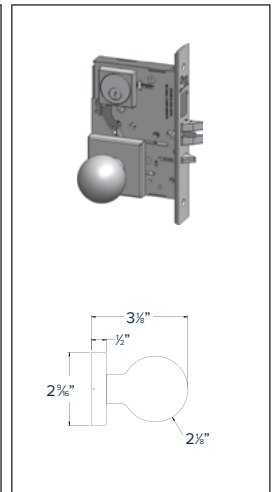

BALL KNOB — KJSJ



*Knobs are not ADA Compliant

J Series Escutcheon Trim

- Levers: Philadelphia, Boston, Miami, Memphis, Houston – Solid Levers
Chicago, Dallas, Los Angeles, Orlando – Hollow Tube Levers
- Trim: Investment Cast Stainless

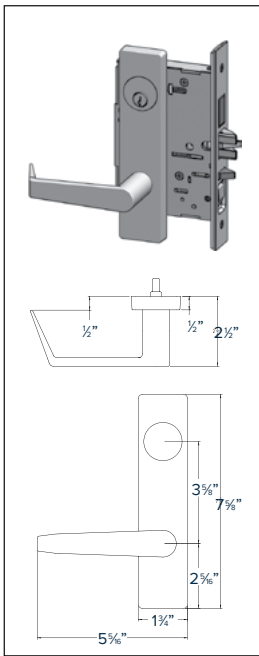

PHILADELPHIA — PJEJ

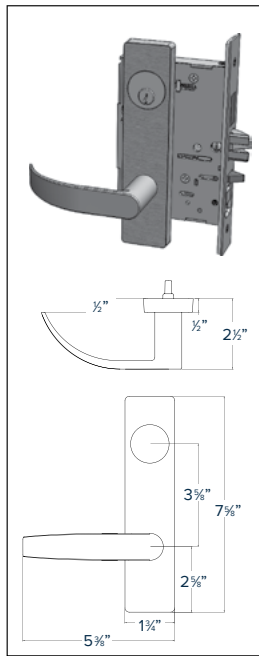

BOSTON — BJEJ

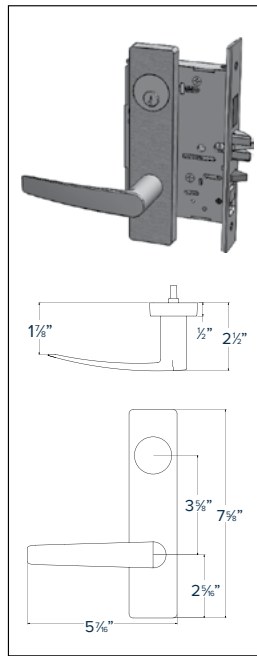

MIAMI — MJEJ

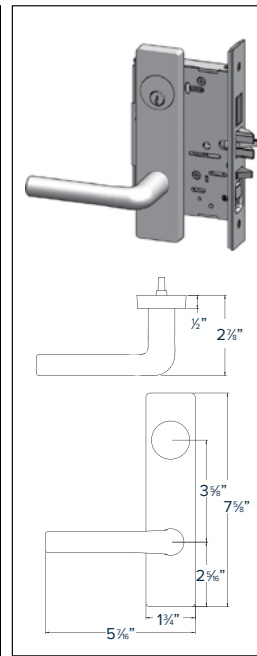

CHICAGO — CJEJ

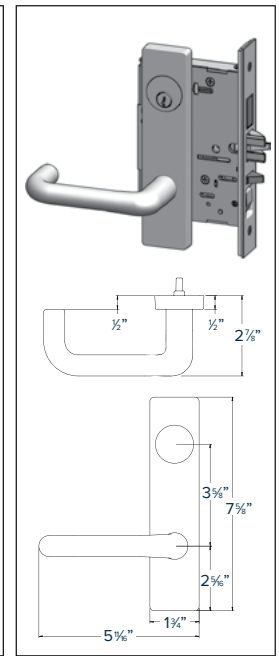

DALLAS — DJEJ

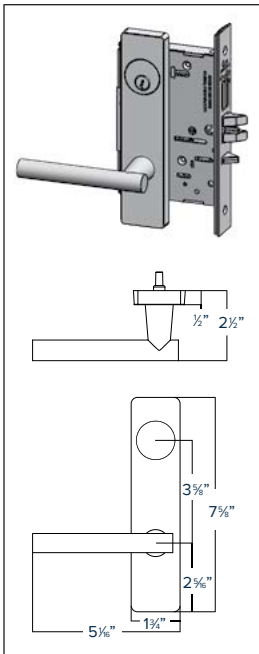

HOUSTON — HJEJ

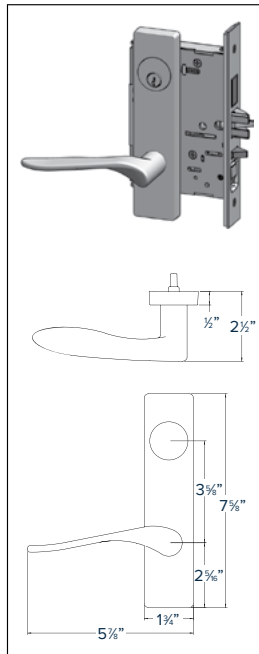

MEMPHIS — TJEJ

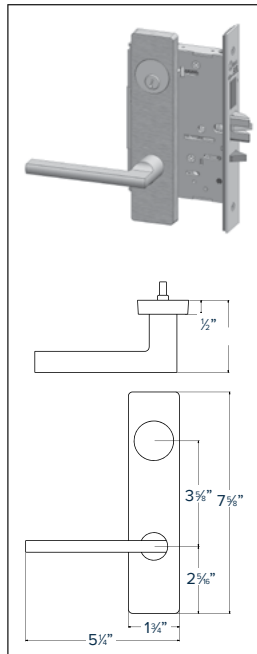

ORLANDO — OJEJ

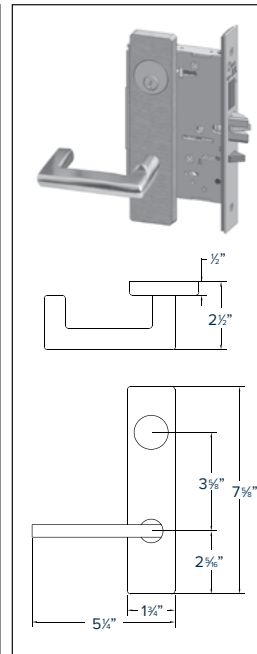

LOS ANGELES — LJEJ

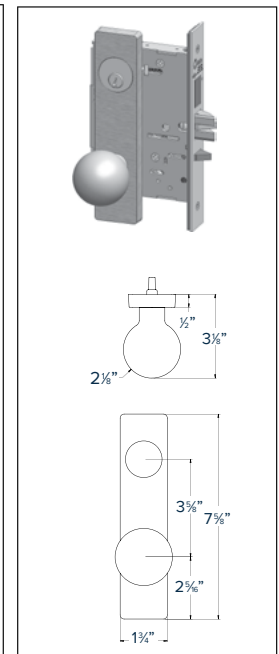

BALL KNOB — KJEJ



*Knobs are not ADA Compliant

J Series Wide Escutcheon Trim

- Levers: Philadelphia, Boston, Miami, Memphis, Houston – Solid Levers
- Chicago, Dallas, Los Angeles, Orlando – Hollow Tube Levers
- Trim: Investment Cast Stainless

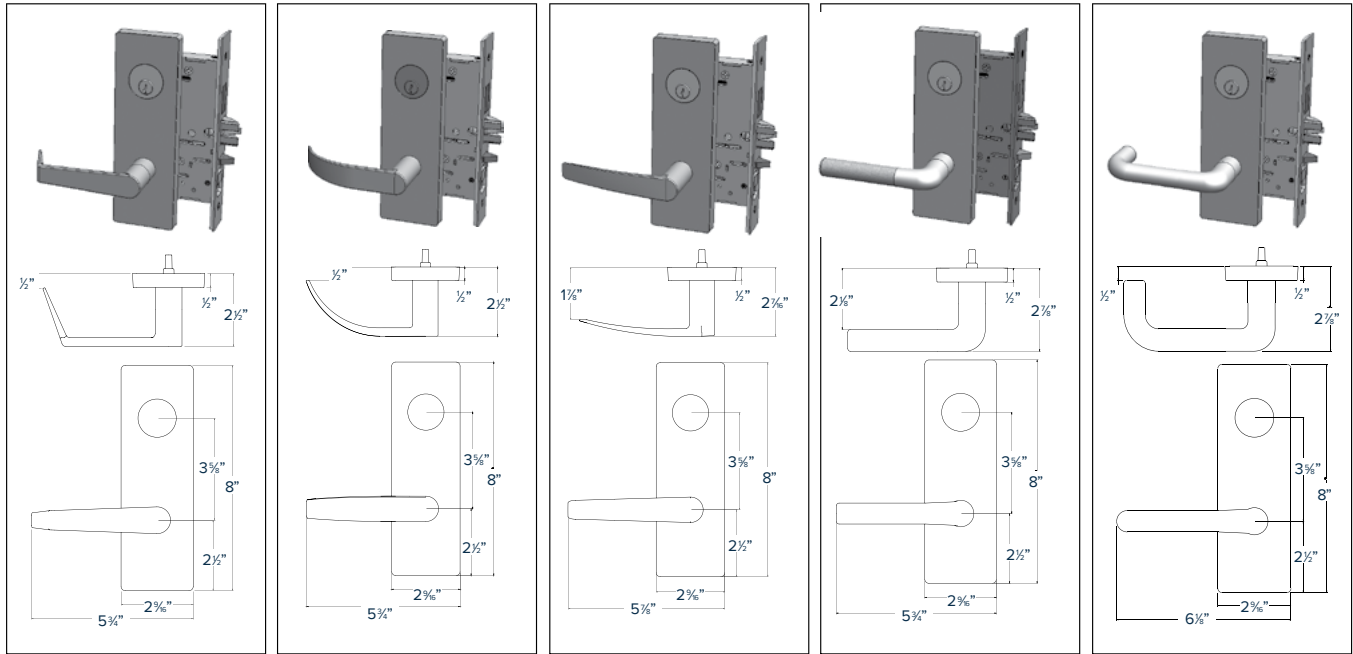

PHILADELPHIA — PJEW

BOSTON — BJEW

MIAMI — MJEW

CHICAGO — CJEW

DALLAS — DJEW

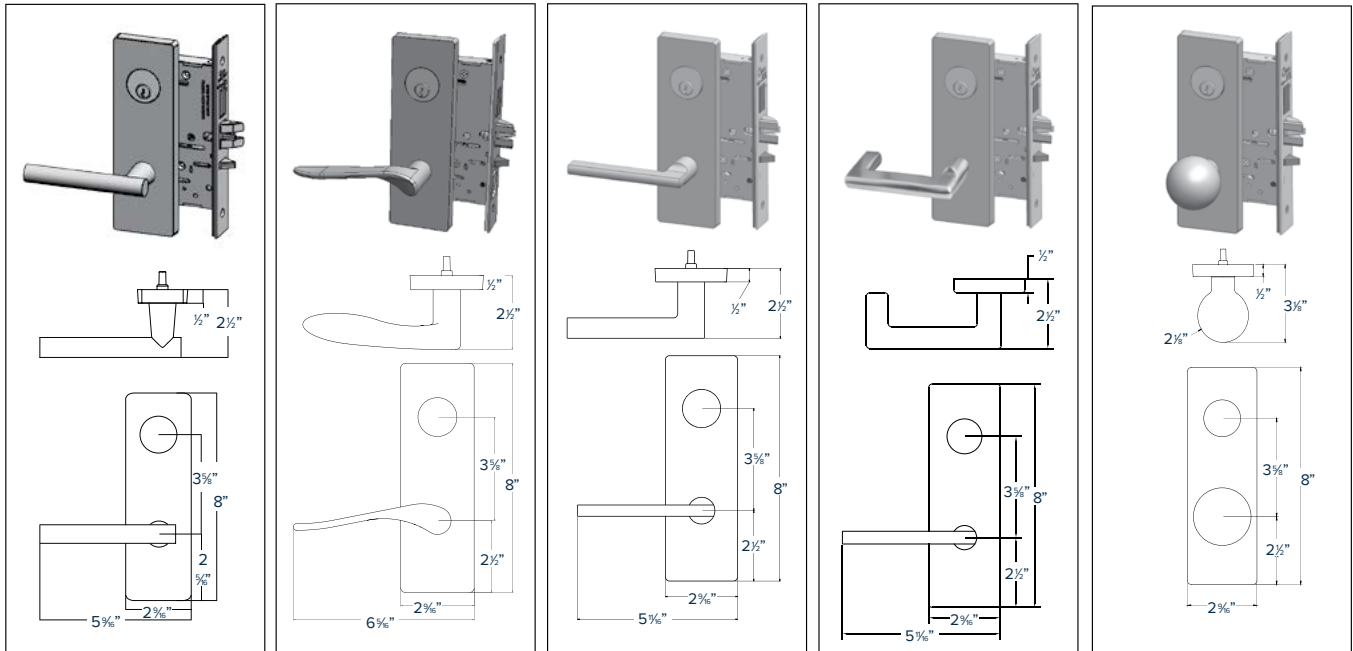

HOUSTON — HJEW

MEMPHIS — TJEW

ORLANDO — OJEW)

LOS ANGELES — LJEW

BALL KNOB — KJEW



ALL LEVERS

*Knobs are not ADA Compliant

Typical Applications

- High-End Residential
- Multi-family
- Offices

Features

- Contemporary decorative trim perfect for high end residential and office work
- Designed to compliment MR Series Mortise locks sharing the same sectional rose diameter and levers
- Investment cast stainless steel trim
- Range of lever styles available
- Available in round rose or square rose
- Uses a slender 2-3/8" diameter rose providing a clean contemporary look



Round Rose Trim
with Dallas Lever



Square Rose Trim
with Orlando Lever

Specifications



| | |
|---|--|
| FOR DOORS: | • For doors 1-3/8" (35mm) to 1-3/4" (44mm) thick standard |
| BACKSET: | • 2-3/4" (70mm) default. Optional: 2-3/8" (60mm); |
| STRIKE: | • "Full Lip" strike default. "T" strike and ASA strike optional |
| ROSE DIMENSIONS: | • Round Rose: 2-3/8" DIA • Square Rose: 2-9/16" |
| DOOR PREP: | • ANSI Standard 115.2, Type 161 for 2-3/4" Backset • Type 160 optional |
| LATCH BOLTS: | • 2-3/4" Backset has 1-1/8" faceplate. 2-3/8" Backset has a 1" faceplate filler |
| HAND: | • Non-handed, except Memphis. (Orlando, Los Angeles, Houston is handed for 211 function only) |
| FINISHES: | • 605 (US3) Bright Brass, 606 (US4) Satin Brass, 612 (US10) Satin Bronze, 613E Dark Oxidized Satin Bronze, 622 (US19) Flat Black, 629 (US32) Bright Stainless Steel, 630 (US32D) Satin Stainless Steel |
| TRIM: | • Stainless Steel Levers and Roses |
| LEVER DESIGNS: | • Philadelphia, Boston, Miami, Chicago, Houston, Memphis, Orlando, Los Angeles, Dallas and Ball Knob. |
| CERTIFICATIONS, LISTINGS, COMPLIANCES: | • Complies with ADA (Americans with Disabilities Act) and ICC/ANSI 117.1 for Accessible and Usable Buildings (except ball knob). |
| WARRANTY: | • Five (5) year limited warranty |

How to Order

TJ SERIES
TUBULAR LOCKS

| QUANTITY | SERIES | FUNCTION | LEVER | ROSE | FINISH | BACKSET | HANDING | STRIKE |
|----------|--------|----------|-------|---|--------|---|--|--|
| 5 | TJ | 176 | PHL | — | 630 | 234 | — | FL |
| | | | PHL | BLANK – Round Rose (Default) SR – Square Rose | 605 | 234 – 2-3/4" Default 238 – 2-3/8" Optional | LH – Left Hand RH – Right Hand | FL – Full Lip Strike (Default) T – 'T' Strike ASA – ANSI/ ASA Strike |
| | | | BSN | | 606 | | | |
| | | | MIA | | 612 | | | |
| | | | CHI | | 613E | | | |
| | | | DAL | | 622 | | | |
| | | | MEM | | 629 | | | |
| | | | ORL | | 630 | | | |
| | | | HOU | | | | | |
| | | | LAX | | | | | |
| | | | KJ | | | | | |

TJ Series

| ANSI NO. | FUNCTION | DESCRIPTION | SECTIONAL | |
|----------|----------|---------------|-----------|---------------------------------|
| | | | 630 | 605, 606, 612 613E, 622, 629 |
| | 125 | Communicating | \$130.00 | \$155.00 |
| F75 | 126 | Passage | \$180.00 | \$205.00 |
| F76 | 176 | Privacy | \$180.00 | \$205.00 |
| | 205 | Double Dummy | \$130.00 | \$155.00 |
| | 211 | Single Dummy | \$100.00 | \$112.00 |

Rose Option

| CODE | DESCRIPTION | LOCK ADJUSTMENT |
|------|-------------|-----------------|
| — | Round Rose | N/C |
| SR | Square Rose | \$10.00 |

Lever / Round Rose



PHILADELPHIA — PHL



BOSTON — BSN



MIAMI — MIA



CHICAGO — CHI



DALLAS — DAL



MEMPHIS — MEM
 (Specify handing)



ORLANDO — ORL
 (Specify handing)



LOS ANGELES — LAX
 (Specify handing)



HOUSTON — HOU
 (Specify handing)



BALL KNOB — KJ



Lever / Square Rose



PHILADELPHIA — PHL



BOSTON — BSN



MIAMI — MIA



CHICAGO — CHI



DALLAS — DAL



MEMPHIS — MEM
 (Specify handing)



ORLANDO — ORL
 (Specify handing)



LOS ANGELES — LAX
 (Specify handing)



HOUSTON — HOU
 (Specify handing)





BALL KNOB — KJ

 **ALL LEVERS**

PDQ Functions

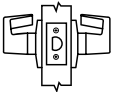
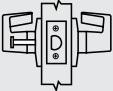
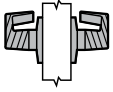
TJ SERIES
TUBULAR LOCKS

| FUNCTION | FUNCTION NUMBER | INSIDE OUTSIDE | DESCRIPTION | ANSI NUMBER |
|--------------------------|-----------------|---|---|-------------|
| NON KEYED | | | | |
| Communicating | 125 |  | <ul style="list-style-type: none"> Latchbolt operated by lever from inside Non removable blank outside | — |
| Passage Closet | 126 |  | <ul style="list-style-type: none"> Latchbolt operated by lever from either side | F75 |
| Privacy Bedroom/Bathroom | 176 |  | <ul style="list-style-type: none"> Latchbolt operated by lever from either side Outside lever locked by push button on inside Outside lever unlocked by emergency release from outside, rotating inside lever, or closing door | F76 |
| Double Dummy | 205 |  | <ul style="list-style-type: none"> Rigid lever both sides No mechanical operation | — |
| Single Dummy | 211 |  | <ul style="list-style-type: none"> Rigid lever outside No mechanical operation | — |



INDICATES RIGID LEVER



Heavy Duty Grade 1 Cylindrical Locks



ASSEMBLED
IN THE USA

More Duty Than You Can Handle

Most manufacturers' approach to lock design ends with simply meeting BHMA/ANSI standards but not PDQ. Our philosophy is to step out of the box and develop innovative designs that take our locks to the next level. We don't just meet the standard, we crush it. Our design doctrine delivers the confidence that locks are built to last, whether the application calls for resistance to high abuse or to millions of cycles of operation without any degradation in performance

XGT/GT Mechanical



Applications

High traffic doors, areas subject to severe abuse, K-12, higher education, Healthcare, public buildings and retro-fit applications.

XGT/GT199A Electro-Mechanical



Applications

Stairwell towers, tenant spaces, pharmacies, computer rooms and high security areas.

XGT/GT135LED School Security Solution



Applications

In K-12 and higher education, indicators are part of the overall security plan. The GT135LED Classroom Intruder lock is designed to allow a staff member to use the inside cylinder to lock the outside of the door. The Intruder function eliminates the need to open the door to check for a locked lever. Simply press the button on the lock and if the red LED lights up the outside lever in locked and secure. If the LED does not light up, the outside lever is unlocked.

SX Ball Knob

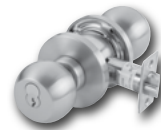

Applications

High traffic areas, Healthcare and commercial buildings.



XGT/ GT199A

Electrified Cylindrical Lock Grade 1 Heavy Duty



ASSEMBLED
IN THE USA

Typical Applications

- Computer Rooms
- High Security Areas
- Pharmacies
- Stairwell Towers
- Tenant Spaces



Specifications



| | |
|---|---|
| PERFORMANCE: | <ul style="list-style-type: none"> • Motor drive factory tested to over 1.4 million cycles (nearly 3x the ANSI/BHMA Grade 1 Standard). |
| RECOMMENDED POWER SUPPLY: | <ul style="list-style-type: none"> • PDQ Model # PS220. <ul style="list-style-type: none"> – Input: 110-120 VAC 60Hz – Output: 24VDC, 2A, filtered and regulated. • Rated for simultaneous operation of 2ea mortise lock assemblies. • Power Supply Requirements: <ul style="list-style-type: none"> – AC/DC Output Voltage – 1A min (filtered and regulated). |
| ELECTRICAL SPECIFICATIONS: | <ul style="list-style-type: none"> • Input voltage: 12-24VDC or 12-24VAC. • Max In-rush current: 1.0A. • Standby current: <ul style="list-style-type: none"> – 12VAC: 12mA. – 24VAC: 10mA. – 12VDC: 3mA. – 24VDC: 5mA. • 12-24VDC @ < 1A initial surge (1 sec), 5mA standby after 30 sec. <ul style="list-style-type: none"> – AC Output Voltage. • 12-24VAC (60Hz) @ < 1A initial surge (1 sec), 15mA standby after 30 sec <p>Note: Operating voltage at ± 10% of rated voltage.</p> |
| CERTIFICATIONS, LISTINGS, COMPLIANCES: | <ul style="list-style-type: none"> • ANSI/UL10C and CAN/ULC-5104 Listed for "Fire Exit Hardware" up to 3 hours for 4'0" x 8'0" maximum single, 8'0" x 8'0" maximum pairs. • Assembled in the U.S.A. with U.S. and foreign material. Meets requirements of the Buy American Act as a COTS product manufactured in the United States. |
| WARRANTY: | <ul style="list-style-type: none"> • 25-Years Mechanical / 2-Years Electronic |

Trim/Levers



ALL LEVERS



PHILADELPHIA — PHL



SFL



LFL



BOSTON — BSN



SFL



MIAMI — MIA



SFL



ASSEMBLED
IN THE USA



Outside Lever Unlocked



To Check the Security of the Outside Lever, Press the Button. If the Red Led Lights Up, that Confirms the Outside Lever is Locked and Secure.

Easy-to-Read LED Indicator Confirms the Door is Locked.

XGT/GT 135 LED Classroom Intruder Cylindrical Lock is designed to allow a staff member to use the inside cylinder to lock the outside of the door, without compromising safety to the occupants in the room. But how does a staff member know if the outside lever is locked?



Until now, it required opening the door and checking the lever. PDQ's 135 LED Classroom Intruder function eliminates the need to open the door. Simply press the button on the lock, and...if the Red LED lights up, the outside lever is locked and secure. If the Red LED does not light up, this indicates the outside lever is not locked and secure.

Features



- Complies with California Education Code (Functions GT135, GT135LED, GT145)
- Red LED (Light Emitting Diode) outside lever status indicator.
- Pushing the button located on the rose of the inside lock, Red LED illuminates indicating the outside lever is locked.
- Offered with cylinder housings compatible with Best® Small Format Inter-changeable cores, Schlage® Large Format Interchangeable cores and most others.
- Large Format Inter-changeable cores only available with PHL lever.
- Keying options available, compatible with most key systems.
- Battery life rating: 10 years*
- Battery type: CR1220
- Patented (US Patent #9,187,928)
- Factory tested to over 2 million cycles (2 times the ANSI/BHMA Grade 1 std)
- Lever torque tested to 2,100 in-lbs (3 times the ANSI/BHMA Grade 1 std)

Status Indicator Locks

- GT135LED
- GT135
- GT145

Time Out Locks

- GT173

School Security Functions

Vestibule Class Room Security with LED Status Indicator

Vestibule Class Room Security without LED Status Indicator

Vestibule Class Room Security with Lock Directional Arrow (No LED Indicator)

Time Out Lock

XGT SERIES

Grade 1 Extra Heavy Duty Cylindrical Lock



ASSEMBLED
IN THE USA

Typical Applications

- Federal and State Government
- Healthcare
- Higher Education
- Hospitality
- Houses of Worship
- Industrial
- K-12 Education
- Offices
- Public Buildings



Specifications



| | |
|---|--|
| FOR DOORS: | • 1-3/4" to 2-1/4" thick • Preset for 1-3/4" door |
| APPLICATION: | • Through door thru-bolting |
| DOOR PREP: | • Standard ANSI A156.115 (161) for Cylindrical Locks |
| BACKSET: | • 2-3/4" Standard. 2-3/8", 2-3/4"FF, 3-3/4" and 5" Optional (Ordered from factory only). • Heavy duty diecast, investment cast, chromated cold rolled steel and stainless steel mechanism. • Billet Steel spindles for locking functions |
| FRONT: | • 2-1/4" x 1-1/8" • Stainless Steel or Wrought Brass • Beveled 1/8" in 2" |
| STRIKE | • ASA standard • T-Strike or Full Lip Strike optional • Stainless Steel or Wrought Brass |
| LEVERS: | • Philadelphia (SFL and LFL), Boston (SFL), Miami (SFL) |
| ROSE: | • 3-3/8" DIA Wrought |
| LATCHBOLT: | • 9/16" Throw Deadlocking • 3/4" Latch projection for available as option. |
| HAND: | • Non-handed |
| TRIM: | • Solid diecast PHL, BSN or MIA Levers • 41° Lever Rotation Standard with 2-3/4" Backset • Wrought Brass Roses, Concealed Screws • 65° Lever Rotation Standard with 3/4" latch for double doors (Ordered from factory only) and all 2-3/8", 3-3/4" and 5" Backsets (Ordered from factory only) |
| KEYS: | • Two (2) per Lock |
| KEYWAYS | • SCC standard (Schlage C Compatible) • Also available in keyways of other manufacturers |
| INTERCHANGEABLE CORE: | • Available for all keyed functions • 6 or 7-pin • Large Format IC Core available for PHL Lever ONLY. • Compatible with Best, Falcon and Arrow small format IC cores |
| CYLINDER: | • 6-pin Brass Insert Cylinder keyed to 5-pins • Standard High Security and UL437 Cylinders Available |
| KEYING: | • Options: MK, CMK or GMK • Zero Bitted (KO), Keyed Different (KD) or Keyed Alike (KA) Can be keyed into existing master key systems |
| FINISHES: | • 605 (US3), 606 (US4), 612 (US10), 613E , 619 (US15), 622 (US19), 625 (US26), 626 (US26D) • Optional Antimicrobial Coating 626 (USD26D) only† |
| CERTIFICATIONS, LISTINGS, COMPLIANCES: | • UL listed for 3 hrs, for single doors up to 4'0" x 8'0". • Optional 3/4" (19mm) throw deadlocking fire latch (FRL) available for pairs of doors • Certified to ANSI/BHMA A156.2, Grade 1 • California Education Code Compliant (Functions XGT135, XGT135LED, XGT145) • Federal Specification FF-H-10C (Superseded by A156.2) • Approved for Florida HVHZ (High Velocity Hurricane Zone). PDQ Product Approval: FL 21376. • Design load rating: ± 70.0 PSF for single door (3' x 7') • Complies with ADA (Americans with Disabilities Act) and ICC/ANSI 117.1 for Accessible and Usable Buildings |
| WARRANTY: | • Limited Lifetime Warranty |
| COUNTRY OF ORIGIN: | • Proudly Assembled in the U.S.A. with U.S. and foreign material. Meets requirements of the Buy American Act as a COTS product manufactured in the United States. |

† Available with antimicrobial powder coating, treated with silver ionic technology that is known to inhibit the growth of microbes.

XGT SERIES

LIST PRICE

Effective July 3, 2023



How to Order

| QUANTITY | SERIES | FUNCTION | LEVER | FINISH | BACKSET | STRIKE | CYLINDER | KEYWAY | KEYING | OPTION |
|----------|--------|----------|-------|--------|------------------|----------------|---|---------|--------|---------------------------------|
| 6 | XGT | 116 | PHL | 626 | 234 | ASA | D | SCC | KD | — |
| | | | BSN | 605 | 234 — | ASA — | D Default | PAGE 39 | | TC1IS — Tactile |
| | | | MIA | 606 | 2-3/4" (default) | ASA (default) | L Less Cylinder | | | Abrasive Coating - Inside only |
| | | | PHL | 612 | 238 — | FL — | SF6 Lock is SFIC prepped w/ 6 pin core | | | TC1OS — Tactile |
| | | | | 613E | 2-3/8" | FL — | SF7 Lock is SFIC prepped w/ 7 pin core | | | Abrasive Coating - Outside only |
| | | | | 619 | 334F — | T — "T" Strike | SFL Lock is SFIC prepped but less core | | | TC2 — Tactile |
| | | | | 622 | 3-3/4x1" | | SFC Lock is SFIC prepped w/ construction core | | | Abrasive Coating - Both Sides |
| | | | | 625 | 334 — | | SFP Lock is SFIC prepped w/ plastic construction core | | | SF — Split Finishes |
| | | | | 626 | 3-3/4" | | LF6 Lock is Schlage LFIC prepped w/ Schlage core | | | LL — Lead-Lined Rose |
| | | | | | 5 — 5" | | LFL Lock is Schlage LFIC prepped but less core | | | DB — Dust Box |
| | | | | | | | LFC Lock is Schlage LFIC prepped w/ construction core | | | AM — Antimicrobial Coating |
| | | | | | | | | | | REX — Request to Exit |
| | | | | | | | PAGE 38 | | | PAGE 40 |

NOTE: Case quantity is 6 / Case weight is 33 lbs. Keyed Functions/ Case weight is 31 lbs. Non-Keyed Functions / For split finishes, designate O/S trim first, then I/S

XGT SERIES
CYLINDRICAL LOCKS

| ANSI NO. | FUNCTION | DESCRIPTION | 626 | 605/606/612 613E/619/622/625 |
|------------------------|----------|---|----------|---------------------------------|
| NON-CYLINDER | | | | |
| F89 | 124 | Exit | | |
| | 125 | Communicating | \$373.00 | \$395.00 |
| F75 | 126 | Passage | | |
| | 173 | Time Out | | |
| | 175 | Hospital / Privacy | | |
| F76 | 176 | Privacy | \$420.00 | \$442.00 |
| F77 | 177 | Patio / Privacy | | |
| | 205 | Double Dummy | \$257.00 | \$279.00 |
| | 211 | Single Dummy | \$175.00 | \$186.00 |
| SINGLE CYLINDER | | | | |
| F86 | 115 | Store Room | | |
| F109 | 116 | Entrance | | |
| F84 | 148 | Classroom | \$484.00 | \$506.00 |
| | 150 | Exit / Twin Communicating | | |
| F82 | 182 | Office / Entry | | |
| | 120 | Security | \$504.00 | \$526.00 |
| | 129 | Exit / Twin Communicating | | |
| F92 | 155 | Service Station | \$544.00 | \$566.00 |
| F90 | 165 | Dormitory / Corridor | | |
| DOUBLE CYLINDER | | | | |
| F87 | 128 | Institution | \$554.00 | \$576.00 |
| F110 | 135 | Classroom / Security | | |
| F110 | 135LED | Classroom/Security w/Red LED Outside Lever Status Indicator | \$723.00 | \$745.00 |
| F110 | 145 | Classroom / Security w/Locking Direction Arrow | | |
| F91 | 137 | Store Door | \$578.00 | \$600.00 |
| F80 | 141 | Communicating | | |
| ELECTRIFIED | | | | |
| | 199A | Store Room | \$964.00 | \$986.00 |

| CYLINDER OPTIONS | ICON | LOCK ADJUSTMENT |
|------------------|---|-----------------|
| D |  | |
| SFL |  | N/C |
| LFL* |  | |

IC Core not included see page 39 for core options

LFIC prep only available in PHL lever and 613E, 622, 626 finish.

NOTES:

- Locks will be furnished with ASA Strike & SCC Keyway unless otherwise stated

Trim/Levers



ALL LEVERS



PHILADELPHIA — PHL

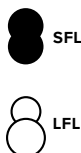

BOSTON — BSN



MIAMI — MIA



Backset

| CODE | DESCRIPTION | LOCK ADJUSTMENT |
|----------------------------------|------------------------------------|-----------------|
| 2-3/4" BACKSET | | |
| 234 | 2-3/4" Deadlocking 2-1/4" x 1-1/8" | N/C |
| 238 | 2-3/8" Deadlocking 2-1/4" x 1" | |
| 3-3/4" BACKSET | | |
| 334F | 2-1/4" x 1-1/8" | \$18 |
| 334 | 2-1/4" x 1" | |
| 5" BACKSET | | |
| 5 | 2-1/4" x 1-1/8" | \$24 |
| 2-3/8" BACKSET | | |
| Contact Factory for Availability | | |

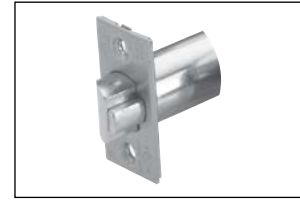

Latchbolt

Strikes

| | CODE | DESCRIPTION | LOCK ADJUSTMENT |
|---|------|--|-----------------|
|  | ASA | ASA Strike (any finish) 1-1/4" x 4-7/8" | N/C |
|  | T | T-Strike (any finish) 1-1/8" x 2-3/4" | |
|  | FL | Full Lip Strike (any finish) 1-5/8" x 2-1/4" | |

NOTES:

- Specify finish for Strikes & Latchbolts if ordered separately

NOTES:

- Specify finish for cylinders ordered separately
- Kwikset cylinder available in 5 pin only
- Specify KD, KA4, or 1 bitted 6 pin cylinder keyed for 5 pin

Keyways and Cylinders

| PDQ KEYWAY | COMPATIBLE WITH | SOLD WITH LOCK |
|--|---|----------------|
| AR1 | Arrow / AR1 | N/C |
| CO59A1 | Corbin / 59A1 | |
| CO6 | Corbin / 60 | |
| CL4 | Corbin / L4 | |
| RUD | Russwin / D1 | |
| SCE | Schlage / E | |
| SCC | Schlage / C | |
| SCC-K | Schlage / C-K | |
| SAL | Sargent / LA | |
| RA-RC | Sargent / RA-RC | |
| YA8 | Yale / E1R | |
| GA | Yale / GA | |
| FAL | Falcon / E-R | |
| KW | Kwikset | |
| TA | PDQ / TA (Restricted. Limited to Grandmaster systems w/4 masters) | |
| Dummy | — | |
| T-Turn | — | |
| L | Less Cylinder | |
| HIGH SECURITY CYLINDERS AND CORES | | |
| SEE HIGH SECURITY CYLINDERS AND CORES SECTION, PAGE 118. | | |



Key in Knob/Lever Cylinder



UL 437 and High Security Cylinders

Cores and Keyways

| DESCRIPTION | PDQ NO. | ADD |
|--|------------------|---------|
| SMALL FORMAT UNCOMBINATED | | |
| 6 Pin Cores | I5206 + KEYWAY | \$40.00 |
| 7 Pin Cores | I5207 + KEYWAY | |
| COMBINATED | | |
| 6 Pin Cores | I5206-1 + KEYWAY | \$60.00 |
| 7 Pin Cores | I5207-1 + KEYWAY | |
| BEST[®] Compatible | | |
| A (DEFAULT), B, C, D, E, F, G, H, J, K, L, M, Q, | | |
| WA, WB, WC, WG, WH, TB, TD, TE, & R | | |
| PDQ Exclusive | | |
| PDQ1, PDQ2 | | |
| PDQ Exclusive and Restricted | | |
| PDQ3 | | |
| SFIC CONSTRUCTION | | |
| Construction Core 6-pin only | | \$60.00 |
| Dummy Construction Core Plastic | | \$8.00 |
| LFIC CONSTRUCTION | | |
| Construction Core 6-pin only. Construction cores are invoiced at shipment and credited upon return. | | \$70.00 |
| IC Tailpiece Assembly | | \$10.00 |
| LFIC COMBINATED | | |
| Schlage compatible LFIC, SCC (Schlage C compatible) keyway | | \$70.00 |
| PDQ TA LFIC Restricted | | |
| LFIC UNCOMBINATED | | |
| Schlage compatible LFIC, SCC (Schlage C compatible) keyway | | \$50.00 |
| HIGH SECURITY IC CORES | | |
| SEE HIGH SECURITY CYLINDERS AND CORES SECTION, PAGE 118. — LFIC REQUIRES LARGE FORMAT LEVER | | |

NOTES:

- Specify finish for IC Cores ordered separately
- Control keys must be ordered separately
- **PDQ1, PDQ2, PDQ3 (Restricted)**, Best A2 & A4 Systems Available

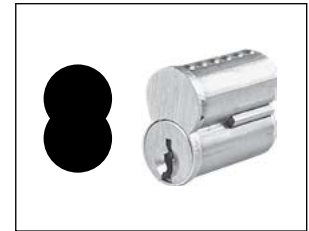

SFL/SFIC Core



LFL/LFIC Schlage Format



UL 437 and High Security Cylinders















Options

| CODE | DESCRIPTION | LIST PRICE |
|--------------|--|------------|
| TCIIS | Tactile Abrasive Coating - Inside only | \$26.00 |
| TCIOS | Tactile Abrasive Coating - Outside only | |
| TC2 | Tactile Abrasive Coating - Both Sides | \$52.00 |
| LL | Lead-Lined Rose | \$214.00 |
| DB | Dust Box | \$8.00 |
| FRL | Fire Rated Latch - 3/4" Throw for double doors | \$99.00 |
| AM | Antimicrobial Coating, Lever Set Includes Inside and Outside Lever and Rose (Not available with 605 or 625 finish) | \$37.00 |
| REX | Request to Exit | \$122.00 |

XGT SERIES
CYLINDRICAL LOCKS

XGT SERIES PARTS

LIST PRICE
Effective July 3, 2023

| | DESCRIPTION | LIST PRICE | FINISHES | | | | | | |
|---|---|------------|----------------------------------|-----------|-----------|-----------|-----------|-----------|-----------|
| | | | N/A | 605 | 606 | 612 | 613E | 625 | 626 |
|  | Push Button For Functions GT155, GT165, GT173, GT175, GT176, GT177, GT182 | \$13 | — | VA91302-5 | VA91302-8 | VA91302-3 | VA91302-6 | VA91302-2 | VA91302-7 |
|  | Outside Rose for All Functions, Inside Rose For All functions except GT135LED, GT145 | \$43 | — | V32006-5 | V32006-8 | V32006-3 | V32006-6 | V32006-2 | V32006-7 |
|  | Inside Rose w/Locking Directional Arrow For Functions GT135LED, GT145 | | — | VA10093-5 | VA10093-8 | VA10093-3 | VA10093-6 | VA10093-2 | VA10093-7 |
|  | "T" STRIKE SQUARE CORNERS 1-1/8" X 2-3/4" X 3/32" | \$17 | — | V919050-5 | V919050-8 | V919050-3 | V919050-6 | V919050-2 | V919050-7 |
|  | ASA ANSI STRIKE 1-1/4" X 4-7/8" X 3/32" | \$38 | — | V91905-5 | V91905-8 | V91905-3 | V91905-6 | V91905-2 | V91905-7 |
|  | "FULL LIP" STRIKE 1-5/8" X 2-1/4" X 3/32" | \$14 | — | V919051-5 | V919051-8 | V919051-3 | V919051-6 | V919051-2 | V919051-7 |
| | SCREW PACK - INCLUDES MOUNTING SCREWS, HEX KEY(M5 X .8) AND PICK. | \$12 | — | VA10030-5 | VA10030-8 | VA10030-3 | VA10030-6 | VA10030-2 | VA10030-7 |
|  | SPACER — For 1-3/8" doors. Sold as a pair. To be installed as a set. | \$64 | V32433 | | | | | | |
|  | EXTENSION — Converts standard latchbolt from 2-3/4" Backset to 5" | \$58 | VA21902 | | | | | | |
| | EXTENSION — Converts standard latchbolt from 2-3/8" Backset to 3-3/4" | | VA21903 | | | | | | |
|  | CENTERING PLATE — 1-1/8" latch Front Filler Plate. Centers and supports latch bolt when used in hollow stile doors must be ordered with lock from factory. | \$75 | V21904 | | | | | | |
|  | DISPOSABLE CORE FOR SFIC | \$9 | VA10100 | | | | | | |
|  | TAILPIECE WITH SPRING FOR SFIC HOUSING | \$12 | VP92905 | | | | | | |
|  | TAILPIECE FOR XGT/GT/GP KEY IN KNOB CYLINDER | \$5 | V32106 | | | | | | |
|  | DUST BOX FOR "T" STRIKE | \$8 | I0251 | | | | | | |
| | DUST BOX FOR ASA (ANSI) | | Y025-SBX | | | | | | |
| | DUST BOX FOR FULL LIP STRIKE | | I0251R | | | | | | |
|  | Boring Jig — Locates off 2-1/8" bore to drill 5/16"DIA anti-rotation through-bolts | \$100 | V11225 | | | | | | |
|  | LEVER RETURN SPRING | \$5 | V32015-1 V32015-2 V32015-3 | | | | | | |

*Available in 626 only. 1-1/8" faceplate-lock must be 2-3/4" Backset.



XGT SERIES
CYLINDRICAL LOCKS

XGT SERIES PARTS

LIST PRICE

Effective July 3, 2023

XGT SERIES
CYLINDRICAL LOCKS

| REPLACEMENT LEVERS | DESCRIPTION | LIST PRICE | FINISHES | | | | | | LIST PRICE | FINISH 626 |
|--|-----------------------------------|------------|----------|----------|----------|----------|----------|----------|------------|------------|
| | | | 605 | 606 | 612 | 613E | 622 | 625 | | |
|  BOSTON | Non-Cylinder Plain | \$150 | V32319-5 | V32319-8 | V32319-3 | V32319-6 | V32319-H | V32319-2 | \$140 | V32319-7 |
| | Non-Cylinder with button lock | | V32321-5 | V32321-8 | V32321-3 | V32321-6 | V32321-H | V32321-2 | | V32321-7 |
| | Conventional Key in Knob/Lever | | V32320-5 | V32320-8 | V32320-3 | V32320-6 | V32320-H | V32320-2 | | V32320-7 |
| | Small Format Interchangeable Core | | V32327-5 | V32327-8 | V32327-3 | V32327-6 | V32327-H | V32327-2 | | V32327-7 |
|  MIAMI | Non-Cylinder Plain | | V32361-5 | V32361-8 | V32361-3 | V32361-6 | V32361-H | V32361-2 | | V32361-7 |
| | Non-Cylinder with button lock | | V32360-5 | V32360-8 | V32360-3 | V32360-6 | V32360-H | V32360-2 | | V32360-7 |
| | Conventional Key in Knob/Lever | | V32362-5 | V32362-8 | V32362-3 | V32362-6 | V32362-H | V32362-2 | | V32362-7 |
| | Small Format Interchangeable Core | | V32364-5 | V32364-8 | V32364-3 | V32364-6 | V32364-H | V32364-2 | | V32364-7 |
|  PHILADELPHIA | Non-Cylinder Plain | | V32305-5 | V32305-8 | V32305-3 | V32305-6 | V32305-H | V32305-2 | | V32305-7 |
| | Non-Cylinder with button lock | | V32307-5 | V32307-8 | V32307-3 | V32307-6 | V32307-H | V32307-2 | | V32307-7 |
| | Conventional Key in Knob/Lever | | V32306-5 | V32306-8 | V32306-3 | V32306-6 | V32306-H | V32306-2 | | V32306-7 |
| | Small Format Interchangeable Core | | V32322-5 | V32322-8 | V32322-3 | V32322-6 | V32322-H | V32322-2 | | V32322-7 |
| | Large Format Interchangeable Core | — | | | | | | V32427-7 | | |





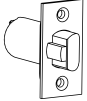
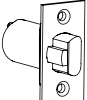
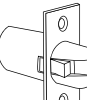

ALL LEVERS

| LATCHBOLTS | DESCRIPTION | LIST PRICE | FINISHES | | | | | | |
|---|--|------------|--------------|--------------|--------------|--------------|--------------|--------------|--------------|
| | | | 605 | 606 | 612 | 613E | 622 | 625 | 626 |
|  | Standard Latchbolt With Dead Latch 2-3/8" Backset, 1/2" Throw for locking functions. Faceplate: 2-1/4" X 1-1/8", Square Corners. See note 1. | \$115 | V91904-521 | V91904-821 | V91904-321 | V91904-621 | V91904-H21 | V91904-221 | V91904-721 |
|  | Standard Latchbolt With Dead Latch 2-3/4" Backset, 9/16" Throw for all functions. Faceplate: 2-1/4" X 1-1/8", Square Corners | \$130 | V91904-511 | V91904-811 | V91904-311 | V91904-611 | V91904-H11 | V91904-211 | V91904-711 |
|  | Latchbolt With Dead Latch For Double Doors 2-3/4" Backset, 3/4" Throw Faceplate: 2-1/4" X 1-1/8", Square Corners | \$260 | V91904-511DD | V91904-811DD | V91904-311DD | V91904-611DD | V91904-H11DD | V91904-211DD | V91904-711DD |

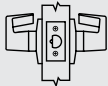
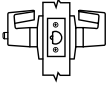
Note: Replacement latch for 3-3/4" Backset applications when used with V21902 extension or factory assembled locks with 2-3/8" Backset. NOT INTENDED FOR FIELD RETROFIT.

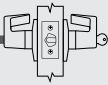
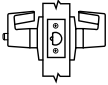
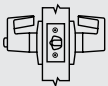
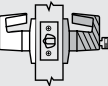
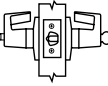
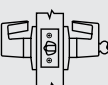
PDQ Functions

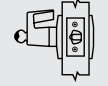
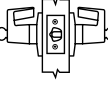
| FUNCTION | FUNCTION NUMBER | INSIDE OUTSIDE | DESCRIPTION | ANSI NUMBER |
|-------------------------------|-----------------|---|--|-------------|
| NON KEYED | | | | |
| Passage / Closet | XGT126™ |  | <ul style="list-style-type: none"> Latchbolt operated by lever from either side at all times | F75 |
| Time Out Lock | XGT173 |  | <ul style="list-style-type: none"> Latchbolt by lever from either side unless push button on outside is depressed. Lock returns to passage mode upon release of push button. Inside lever locked only when pushing button on outside lever. Inside lever unlocked by emergency release of button from outside.  | — |
| Hospital Privacy | XGT175 |  | <ul style="list-style-type: none"> Latchbolt operated by lever from either side or emergency turn piece in outside lever Outside lever locked by push button on inside Outside lever unlocked by emergency turn piece from outside, rotating inside lever, or closing door | — |
| Privacy Bedroom / Bathroom | XGT176™ |  | <ul style="list-style-type: none"> Latchbolt operated by lever from either side or emergency release in outside lever Outside lever locked by push button on inside Outside lever unlocked by emergency release from outside, rotating inside lever, or closing door | F76 |
| Patio | XGT177 |  | <ul style="list-style-type: none"> Latchbolt operated by lever from either side Outside lever locked by push button on inside Outside lever unlocked by rotating inside lever, or closing door Outside lever has non-removable security features | F77 |
| KEYED | | | | |
| Storeroom | XGT115 |  | <ul style="list-style-type: none"> Latchbolt operated by inside lever or key in outside lever Outside lever always fixed | F86 |
| Entrance | XGT116 |  | <ul style="list-style-type: none"> Latchbolt operated by lever from either side or key in outside lever Outside lever locked by push/turn button on inside When outside lever is locked by push button on inside – key from outside, or rotating inside lever unlocks outside lever When outside lever is locked by pushing and turning button on the inside, key from outside or rotating inside lever retracts latch but does not unlock outside lever | F109 |
| Security | XGT120 |  | <ul style="list-style-type: none"> Latchbolt operated by lever from either side Key on outside locks inside lever Key on outside unlocks inside lever Outside keyed lever always free Inside lever has non-removable security features  | — |
| Utility Asylum / Institution | XGT128 |  | <ul style="list-style-type: none"> Both levers rigid Latchbolt retracted by key on both sides Can only gain entry or exit by key | F87 |
| Exit or Twin Communicating | XGT129 |  | <ul style="list-style-type: none"> Latchbolt operated by key in inside lever Inside lever always fixed Blank plate outside Minimum clearance of 1-1/2" between doors Frame depth 7-1/8" | — |
| Vestibule Class Room Security | XGT135 |  | <ul style="list-style-type: none"> Latchbolt operated by lever from either side Key in either lever locks outside lever Key in either lever unlocks outside lever Inside lever always free | F110 |





INDICATES RIGID LEVER

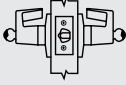
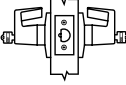
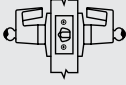
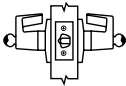
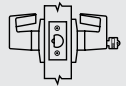

PDQ Functions

XGT SERIES
CYLINDRICAL LOCKS

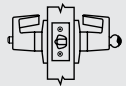
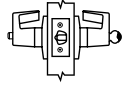
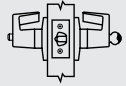
| FUNCTION | FUNCTION NUMBER | INDISE OUTSIDE | DESCRIPTION | ANSI NUMBER |
|-------------------------------------|-----------------|---|---|-------------|
| KEYED | | | | |
| Vestibule Class Room Security | XGT135LED |  | <ul style="list-style-type: none"> Latchbolt operated by lever from either side Key in either lever locks outside lever Key in either lever unlocks outside lever Inside lever always free Red LED Outside Lever Status Indicator Lock Directional Arrow Patent #9,187,928 | F110 |
| Store Door | XGT137 |  | <ul style="list-style-type: none"> Latchbolt operated by lever from either side Both levers locked by key from either side Both levers unlocked by key from either side | F91 |
| Communicating | XGT141 |  | <ul style="list-style-type: none"> Latchbolt operated by lever from either side Key in either side locks or unlocks its own lever independently | F80 |
| Vestibule Class Room Security | XGT145 |  | <ul style="list-style-type: none"> Latchbolt operated by lever from either side Key in either lever locks outside lever Key in either lever unlocks outside lever Inside lever always free Lock Directional Arrow* | F110 |
| Classroom | XGT148 |  | <ul style="list-style-type: none"> Latchbolt operated by lever from either side Outside lever locked by key from outside Outside lever unlocked by key from outside Inside lever always operates latch | F84 |
| Exit or Twin Communicating | XGT150 |  | <ul style="list-style-type: none"> Latchbolt operated by inside lever Blank plate outside Inside lever locked by key inside Inside lever unlocked by key inside Minimum clearance of 1-1/2" between doors Use only in rooms with more than one exit Frame depth 7-1/8" | — |
| Service Station | XGT155 |  | <ul style="list-style-type: none"> Latchbolt operated by lever from either side or key in outside lever Outside lever locked by push button on inside When outside lever is locked by push button on inside – key from outside, rotating inside lever, or closing door unlocks outside lever When outside lever is locked by pushing and turning the slotted button on the inside, key from outside or rotating inside lever retracts latch but does not unlock outside lever | F92 |
| Dormitory / Corridor | XGT165 |  | <ul style="list-style-type: none"> Latchbolt operated by lever from either side or key in outside lever Outside lever locked by key on outside or push button on inside Outside lever unlocked by key in outside lever, closing door, or rotating inside lever Inside lever always free | F90 |
| Entry | XGT182 |  | <ul style="list-style-type: none"> Latchbolt operated by lever from either side or key in outside lever Outside lever locked by push button on inside Outside lever unlocked by key from outside, or rotating inside lever | F82 |

Cross Reference

| ANSI # / FUNCTION | PDQ | SARGENT | CORBIN | SCHLAGE |
|--|---|---------|--------|---------|
| F75 — PASSAGE | XGT 126 | 11U15 | CL3310 | ND10S |
| F76 — PRIVACY | XGT 176 | 11U65 | CL3320 | ND40S |
| F82 — ENTRY | XGT 182 | 11G24 | CL3361 | ND50PD |
| F84 — CLASSROOM | XGT 148 | 11G37 | CL3355 | ND70PD |
| F86 — STORE ROOM | XGT 115 | 11G04 | CL3357 | ND80PD |
| F90 — CORRIDOR | XGT 165 | 11G54 | CL3375 | ND73PD |
| F110 — INTRUDER CLASSROOM | XGT 135 | 11G38 | CL3352 | ND95PD |
| F110 — INTRUDER CLASSROOM W/LED INDICATOR | XGT 135 LED PDQ Exclusive - Patent #9,187,928 | N/A | N/A | N/A |

Lever Cross Reference

| PDQ | SARGENT | CORBIN | SCHLAGE |
|--------------------|---------|--------|---------|
| PHILADELPHIA — PHL | L Lever | NZD | RHO |
| BOSTON — BSN | P Lever | PZD | SPA |
| MIAMI — MIA | B Lever | AZD | ATH |



PHILADELPHIA — PHL



BOSTON — BSN



MIAMI — MIA

Information on this sheet is compiled from public documents and third parties. As a result, PDQ makes no guarantees as to their accuracy, content, quality or availability. Comparisons were made using the technical features only and are not commercial comparisons. Final suitability should be determined by a professional hardware consultant.

 **ALL LEVERS**



ASSEMBLED
IN THE USA

Typical Applications

- Federal and State Government
- Healthcare
- Higher Education
- Hospitality
- Houses of Worship
- Industrial
- K-12 Education
- Offices
- Public Buildings



Specifications



| | |
|---|--|
| FOR DOORS: | • 1-3/4" to 2-1/4" thick • Preset for 1-3/4" door |
| APPLICATION: | • Through door thru-bolting |
| DOOR PREP: | • Standard ANSI A156.115 (I61) for Cylindrical Locks |
| BACKSET: | • 2-3/4" Standard, 2-3/8", 3-3/4" and 5" Optional (Ordered from factory only). |
| CHASSIS: | • Heavy duty diecast, investment cast, chromated cold rolled steel and stainless steel mechanism. Billet Steel spindles for locking functions |
| FRONT: | • 2-1/4" x 1-1/8" • Stainless Steel or Wrought Brass • Beveled 1/8" in 2" |
| STRIKE | • ASA standard • T-Strike or Full Lip Strike optional • Stainless Steel or Wrought Brass |
| LEVERS: | • Philadelphia (SFL and LFL), Boston (SFL), Miami (SFL) |
| ROSE: | • 3-3/8" DIA Wrought |
| LATCHBOLT: | • 9/16" Throw Deadlocking • 3/4" Latch projection for available as option. |
| HAND: | • Non-handed |
| TRIM: | • Solid diecast PHL, BSN or MIA Levers • 41° Lever Rotation Standard with 2-3/4" Backset • Wrought Brass Roses, Concealed Screws • 65° Lever Rotation Standard with 3/4" latch for double doors (Ordered from factory only) and all 2-3/8", 3-3/4" and 5" Backsets (Ordered from factory only) |
| KEYS: | • Two (2) per Lock |
| KEYWAYS | • SCC standard (Schlage C Compatible) • Also available in keyways of other manufacturers |
| INTERCHANGEABLE CORE: | • Available for all keyed functions • 6 or 7-pin • Large Format IC Core available for PHL Lever ONLY. • Compatible with Best, Falcon and Arrow small format IC cores |
| CYLINDER: | • 6-pin Brass Insert Cylinder keyed to 5-pins • Standard High Security and UL437 Cylinders Available |
| KEYING: | • Options: MK, CMK or GMK • Zero Bitted (KO), Keyed Different (KD) or Keyed Alike (KA) Can be keyed into existing master key systems |
| FINISHES: | • 605 (US3), 606 (US4), 612 (US10), 613E, 619 (US15), 622 (US19), 625 (US26), 626 (US26D) • Optional Antimicrobial Coating 626 (USD26D) only† |
| CERTIFICATIONS, LISTINGS, COMPLIANCES: | • UL listed for 3 hrs, for single doors up to 4'0" x 8'0" • Optional 3/4" (19mm) throw deadlocking fire latch (FRL) available for pairs of doors • Certified to ANSI/BHMA A156.2, Grade 1 • California Education Code Compliant (Functions GT135, GT135LED, GT145) • Federal Specification FF-H-10C (Superseded by A156.2) • Approved for Florida HVHZ (High Velocity Hurricane Zone). PDQ Product Approval: FL 21376. Design load rating: ± 70.0 PSF for single door (3' x 7') • Complies with ADA (Americans with Disabilities Act) and ICC/ANSI 117.1 for Accessible and Usable Buildings |
| WARRANTY: | • Twenty-five (25) year Limited Warranty |
| COUNTRY OF ORIGIN: | • Proudly Assembled in the U.S.A. with U.S. and foreign material. Meets requirements of the Buy American Act as a COTS product manufactured in the United States. |

† Available with antimicrobial powder coating, treated with silver ionic technology that is known to inhibit the growth of microbes.

GT SERIES

LIST PRICE

Effective July 3, 2023

How to Order



| QUANTITY | SERIES | FUNCTION | LEVER | FINISH | BACKSET | STRIKE | CYLINDER | KEYWAY | KEYING | OPTION |
|----------|--------|----------|-------|--------|-----------------|----------------|---|---------|--------|--|
| 6 | GT | 150 | PHL | 626 | 234 | ASA | D | SCC | KD | — |
| | | | BSN | 605 | 234 — 2-3/4" | ASA — ANSI/ | D Default | PAGE 49 | | TC1S — Tactile Abrasive Coating - Inside only TC1OS — Tactile Abrasive Coating - Outside only TC2 — Tactile Abrasive Coating - Both Sides SF — Split Finishes LL — Lead-Lined Rose DB — Dust Box AM — Antimicrobial Coating REX — Request to Exit |
| | | | MIA | 606 | (default) | ASA (default) | L Less Cylinder | | | |
| | | | PHL | 612 | 238 — 2-3/8" | FL — Full Lip | SF6 Lock is SFIC prepped w/ 6 pin core | | | |
| | | | | 613E | 334F — 3-3/4x1" | T — "T" Strike | SF7 Lock is SFIC prepped w/ 7 pin core | | | |
| | | | | 619 | 334 — 3-3/4" | | SFL Lock is SFIC prepped but less core | | | |
| | | | | 622 | 5 — 5" | | SFC Lock is SFIC prepped w/ construction core | | | |
| | | | | 625 | | | SFP Lock is SFIC prepped w/ plastic construction core | | | |
| | | | | 626 | | | LF6 Lock is Schlage LFIC prepped w/ Schlage core | | | |
| | | | | | | | LFL Lock is Schlage LFIC prepped but less core | | | |
| | | | | | | | LFC Lock is Schlage LFIC prepped w/ construction core | | | |
| PAGE 48 | | | | | | | | | | PAGE 50 |

NOTE: Case quantity is 6/ case weight is 33lbs. Keyed Functions/Case Weight is 31lbs. Non-Keyed Functions/ For split finishes, designate O/S trim first, then I/S

GT SERIES
CYLINDRICAL LOCKS

Locksets - Standard and Interchangeable Cores

| ANSI NO. | FUNCTION | DESCRIPTION | 626 | 605/606/612 613E/619/622/625 |
|------------------------|----------|---|----------|---------------------------------|
| NON-CYLINDER | | | | |
| F89 | 124 | Exit | \$338.00 | \$360.00 |
| | 125 | Communicating | | |
| F75 | 126 | Passage | \$385.00 | \$407.00 |
| | 173 | Time Out | | |
| | 175 | Hospital / Privacy | | |
| F76 | 176 | Privacy | \$222.00 | \$244.00 |
| F77 | 177 | Patio / Privacy | | |
| | 205 | Double Dummy | \$140.00 | \$151.00 |
| | 211 | Single Dummy | | |
| SINGLE CYLINDER | | | | |
| F86 | 115 | Store Room | \$449.00 | \$471.00 |
| F109 | 116 | Entrance | | |
| F84 | 148 | Classroom | | |
| | 150 | Exit / Twin Communicating | | |
| F82 | 182 | Office / Entry | | |
| | 120 | Security | \$469.00 | \$491.00 |
| | 129 | Exit / Twin Communicating | \$509.00 | \$531.00 |
| F92 | 155 | Service Station | | |
| F90 | 165 | Dormitory / Corridor | | |
| DOUBLE CYLINDER | | | | |
| F87 | 128 | Institution | \$519.00 | \$541.00 |
| F110 | 135 | Classroom / Security | | |
| F110 | 135LED | Classroom/Security w/Red LED Outside Lever Status Indicator | \$688.00 | \$710.00 |
| F110 | 145 | Classroom / Security w/Locking Direction Arrow | \$543.00 | \$565.00 |
| F91 | 137 | Store Door | | |
| F80 | 141 | Communicating | | |
| ELECTRIFIED | | | | |
| | 199A | Store Room | \$929.00 | \$951.00 |

| CYLINDER OPTIONS | ICON | LOCK ADJUSTMENT |
|------------------|---|-----------------|
| D |  | |
| SFL |  | N/C |
| LFL* |  | |

IC Core not included see page 49 for core options.

LFIC prep only available in PHL lever and 613E, 622, 626 finish.

NOTES:
• Locks will be furnished with ASA Strike & SCC Keyway unless otherwise stated

Trim/Levers



 ALL LEVERS

PHILADELPHIA — PHL

BOSTON — BSN

MIAMI — MIA



Backset

| CODE | DESCRIPTION | LOCK ADJUSTMENT |
|-----------------------|------------------------------------|-----------------|
| 2-3/4" BACKSET | | |
| 234 | 2-3/4" Deadlocking 2-1/4" x 1-1/8" | N/C |
| 238 | 2-3/8" Deadlocking 2-1/4" x 1" | |
| 3-3/4" BACKSET | | |
| 334F | 2-1/4" x 1-1/8" | \$18 |
| 334 | 2-1/4" x 1" | |
| 5" BACKSET | | |
| 5 | 2-1/4" x 1-1/8" | \$24 |



Latchbolt

GT SERIES
CYLINDRICAL LOCKS

Strikes

| | CODE | DESCRIPTION | LOCK ADJUSTMENT |
|---|------|--|-----------------|
|  | ASA | ASA Strike (any finish) 1-1/4" x 4-7/8" | N/C |
|  | T | T-Strike (any finish) 1-1/8" x 2-3/4" | |
|  | FL | Full Lip Strike (any finish) 1-5/8" x 2-1/4" | |

NOTES:

- Specify finish for Strikes & Latchbolts if ordered separately

NOTES:

- Specify finish for cylinders ordered separately
- Kwikset cylinder available in 5 pin only
- Specify KD, KA4, or 1 bitted 6 pin cylinder keyed for 5 pin

Keyways and Cylinders

| PDQ KEYWAY | COMPATIBLE WITH | SOLD WITH LOCK |
|--|---|----------------|
| AR1 | Arrow / AR1 | N/C |
| CO59A1 | Corbin / 59A1 | |
| CO6 | Corbin / 60 | |
| CL4 | Corbin / L4 | |
| RUD | Russwin / D1 | |
| SCE | Schlage / E | |
| SCC | Schlage / C | |
| SCC-K | Schlage / C-K | |
| SAL | Sargent / LA | |
| RA-RC | Sargent / RA-RC | |
| YA8 | Yale / E1R | |
| GA | Yale / GA | |
| FAL | Falcon / E-R | |
| KW | Kwikset | |
| TA | PDQ / TA (Restricted. Limited to Grandmaster systems w/4 masters) | |
| Dummy | — | |
| T-Turn | — | |
| L | Less Cylinder | Deduct \$4.00 |
| HIGH SECURITY CYLINDERS AND CORES | | |
| SEE HIGH SECURITY CYLINDERS AND CORES SECTION, PAGE 118. | | |

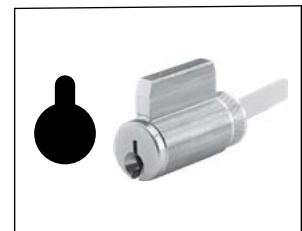

Key in Knob/Lever Cylinder



UL 437 and High Security Cylinders

Cores and Keyways

| DESCRIPTION | PDQ NO. | ADD |
|--|------------------|---------|
| SMALL FORMAT UNCOMBINATED | | |
| 6 Pin Cores | I5206 + KEYWAY | \$40.00 |
| 7 Pin Cores | I5207 + KEYWAY | |
| COMBINATED | | |
| 6 Pin Cores | I5206-1 + KEYWAY | \$60.00 |
| 7 Pin Cores | I5207-1 + KEYWAY | |
| BEST™ Compatible | | |
| A (DEFAULT), B, C, D, E, F, G, H, J, K, L, M, Q, | | |
| WA, WB, WC, WG, WH, TB, TD, TE, & R | | |
| PDQ Exclusive | | |
| PDQ1, PDQ2 | | |
| PDQ Exclusive and Restricted | | |
| PDQ3 | | |
| SFIC CONSTRUCTION | | |
| Construction Core 6-pin only | | \$60.00 |
| Dummy Construction Core Plastic | | \$8.00 |
| LFIC CONSTRUCTION | | |
| Construction Core 6-pin only. Construction cores are invoiced at shipment and credited upon return. | | \$70.00 |
| IC Tailpiece Assembly | | \$10.00 |
| LFIC COMBINATED | | |
| Schlage compatible LFIC, SCC (Schlage C compatible) keyway | | \$70.00 |
| PDQ TA LFIC Restricted | | |
| LFIC UNCOMBINATED | | |
| Schlage compatible LFIC, SCC (Schlage C compatible) keyway | | \$50.00 |
| HIGH SECURITY IC CORES | | |
| SEE HIGH SECURITY CYLINDERS AND CORES SECTION, PAGE 118. — LFIC REQUIRES LARGE FORMAT LEVER | | |

NOTES:

- Specify finish for IC Cores ordered separately
- Control keys must be ordered separately
- **PDQ1, PDQ2, PDQ3 (Restricted)**, Best A2 & A4 Systems Available

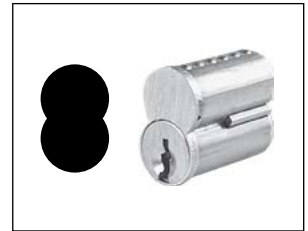

SFL/SFIC Core

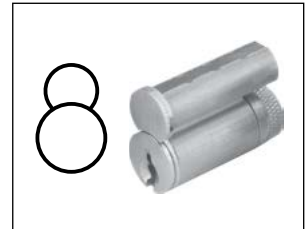

LFL/LFIC Schlage Format



UL 437 and High Security Cylinders

GT SERIES
CYLINDRICAL LOCKS















Options

| CODE | DESCRIPTION | LIST PRICE |
|-------|--|------------|
| TC1IS | Tactile Abrasive Coating - Inside only | \$26.00 |
| TC1OS | Tactile Abrasive Coating - Outside only | |
| TC2 | Tactile Abrasive Coating - Both Sides | \$52.00 |
| LL | Lead-Lined Rose | \$214.00 |
| DB | Dust Box | \$8.00 |
| FRL | Fire Rated Latch - 3/4" Throw for double doors | \$99.00 |
| AM | Antimicrobial Coating, Lever Set Includes Inside and Outside Lever and Rose (Not available with 605 or 625 finish) | \$37.00 |
| REX | Request to Exit | \$122.00 |

GT SERIES
CYLINDRICAL LOCKS

GT SERIES PARTS

LIST PRICE
Effective July 3, 2023

| | DESCRIPTION | LIST PRICE | FINISHES | | | | | | | |
|---|---|------------|----------------------------------|-----------|-----------|-----------|-----------|-----------|-----------|-----------|
| | | | N/A | 605 | 606 | 612 | 613E | 622 | 625 | 626 |
|  | Push Button For Functions GT155, GT165, GT173, GT175, GT176, GT177, GT182 | \$13 | — | VA91302-5 | VA91302-8 | VA91302-3 | VA91302-6 | VA91302-H | VA91302-2 | VA91302-7 |
|  | Outside Rose for All Functions, Inside Rose For All functions except GT135LED, GT145 | \$43 | — | V32006-5 | V32006-8 | V32006-3 | V32006-6 | V32006-H | V32006-2 | V32006-7 |
|  | Inside Rose w/Locking Directional Arrow For Functions GT135LED, GT145 | | — | VA10093-5 | VA10093-8 | VA10093-3 | VA10093-6 | VA10093-H | VA10093-2 | VA10093-7 |
|  | "T" STRIKE SQUARE CORNERS 1-1/8" X 2-3/4" X 3/32" | \$17 | — | V919050-5 | V919050-8 | V919050-3 | V919050-6 | V919050-H | V919050-2 | V919050-7 |
|  | ASA ANSI STRIKE 1-1/4" X 4-7/8" X 3/32" | \$38 | — | V91905-5 | V91905-8 | V91905-3 | V91905-6 | V91905-H | V91905-2 | V91905-7 |
|  | "FULL LIP" STRIKE 1-5/8" X 2-1/4" X 3/32" | \$14 | — | V919051-5 | V919051-8 | V919051-3 | V919051-6 | V919051-H | V919051-2 | V919051-7 |
| | SCREW PACK - INCLUDES MOUNTING SCREWS, HEX KEY(M5 X .8) AND PICK. | \$12 | — | VA10030-5 | VA10030-8 | VA10030-3 | VA10030-6 | VA10030-H | VA10030-2 | VA10030-7 |
|  | SPACER — For 1-3/8" doors. Sold as a pair. To be installed as a set. | \$64 | V32433 | | | | | | | |
|  | EXTENSION — Converts standard latchbolt from 2-3/4" Backset to 5" | \$58 | VA21902 | | | | | | | |
| | EXTENSION — Converts standard latchbolt from 2-3/8" Backset to 3-3/4" | | VA21903 | | | | | | | |
|  | CENTERING PLATE — 1-1/8" latch Front Filler Plate. Centers and supports latch bolt when used in hollow stile doors must be ordered with lock from factory. | \$75 | V21904 | | | | | | | |
|  | DISPOSABLE CORE FOR SFIC | \$9 | VA10100 | | | | | | | |
|  | TAILPIECE WITH SPRING FOR SFIC HOUSING | \$12 | VP92905 | | | | | | | |
|  | TAILPIECE FOR XGT/GT/GP KEY IN KNOB CYLINDER | \$5 | V32106 | | | | | | | |
|  | DUST BOX FOR "T" STRIKE | \$8 | I0251 | | | | | | | |
| | DUST BOX FOR ASA (ANSI) | | Y025-SBX | | | | | | | |
| | DUST BOX FOR FULL LIP STRIKE | | I0251R | | | | | | | |
|  | Boring Jig — Locates off 2-1/8" bore to drill 5/16"DIA anti-rotation through-bolts | \$100 | V11225 | | | | | | | |
|  | LEVER RETURN SPRING | \$5 | V32015-1 V32015-2 V32015-3 | | | | | | | |

GT SERIES
CYLINDRICAL LOCKS



*Available in 626 only. 1-1/8" faceplate-lock must be 2-3/4" Backset.

GT SERIES PARTS

LIST PRICE

Effective July 3, 2023

GT SERIES
CYLINDRICAL LOCKS

| REPLACEMENT LEVERS | DESCRIPTION | LIST PRICE | FINISHES | | | | | | LIST PRICE | FINISH 626 | |
|--|-----------------------------------|------------|----------|----------|----------|----------|----------|----------|------------|------------|----------|
| | | | 605 | 606 | 612 | 613E | 622 | 625 | | | |
|  BOSTON | Non-Cylinder Plain | \$150 | V32319-5 | V32319-8 | V32319-3 | V32319-6 | V32319-H | V32319-2 | \$140 | V32319-7 | |
| | Non-Cylinder with button lock | | V32321-5 | V32321-8 | V32321-3 | V32321-6 | V32321-H | V32321-2 | | V32321-7 | |
| | Conventional Key in Knob/Lever | | V32320-5 | V32320-8 | V32320-3 | V32320-6 | V32320-H | V32320-2 | | V32320-7 | |
| | Small Format Interchangeable Core | | V32327-5 | V32327-8 | V32327-3 | V32327-6 | V32327-H | V32327-2 | | V32327-7 | |
|  MIAMI | Non-Cylinder Plain | | V32361-5 | V32361-8 | V32361-3 | V32361-6 | V32361-H | V32361-2 | | V32361-7 | |
| | Non-Cylinder with button lock | | V32360-5 | V32360-8 | V32360-3 | V32360-6 | V32360-H | V32360-2 | | V32360-7 | |
| | Conventional Key in Knob/Lever | | V32362-5 | V32362-8 | V32362-3 | V32362-6 | V32362-H | V32362-2 | | V32362-7 | |
| | Small Format Interchangeable Core | | V32364-5 | V32364-8 | V32364-3 | V32364-6 | V32364-H | V32364-2 | | V32364-7 | |
|  PHILADELPHIA | Non-Cylinder Plain | | - | V32305-5 | V32305-8 | V32305-3 | V32305-6 | V32305-H | | V32305-2 | V32305-7 |
| | Non-Cylinder with button lock | | | V32307-5 | V32307-8 | V32307-3 | V32307-6 | V32307-H | | V32307-2 | V32307-7 |
| | Conventional Key in Knob/Lever | | | V32306-5 | V32306-8 | V32306-3 | V32306-6 | V32306-H | | V32306-2 | V32306-7 |
| | Small Format Interchangeable Core | | | V32322-5 | V32322-8 | V32322-3 | V32322-6 | V32322-H | | V32322-2 | V32322-7 |
| | Large Format Interchangeable Core | | | | | | | | V32427-7 | | |





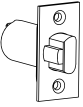
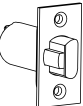
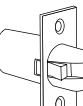



ALL LEVERS

| LATCHBOLTS | DESCRIPTION | LIST PRICE | FINISHES | | | | | | |
|---|--|------------|--------------|--------------|--------------|--------------|--------------|--------------|--------------|
| | | | 605 | 606 | 612 | 613E | 622 | 625 | 626 |
|  | Standard Latchbolt With Dead Latch 2-3/8" Backset, 1/2" Throw for locking functions. Faceplate: 2-1/4" X 1-1/8", Square Corners. See note 1. | \$115 | V91904-521 | V91904-821 | V91904-321 | V91904-621 | V91904-H21 | V91904-221 | V91904-721 |
|  | Standard Latchbolt With Dead Latch 2-3/4" Backset, 9/16" Throw for all functions. Faceplate: 2-1/4" X 1-1/8", Square Corners | \$130 | V91904-511 | V91904-811 | V91904-311 | V91904-611 | V91904-H11 | V91904-211 | V91904-711 |
|  | Latchbolt With Dead Latch For Double Doors 2-3/4" Backset, 3/4" Throw Faceplate: 2-1/4" X 1-1/8", Square Corners | \$260 | V91904-511DD | V91904-811DD | V91904-311DD | V91904-611DD | V91904-H11DD | V91904-211DD | V91904-711DD |

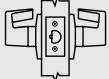
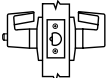
Note: Replacement latch for 3-3/4" Backset applications when used with V21902 extension or factory assembled locks with 2-3/8" Backset. NOT INTENDED FOR FIELD RETROFIT.

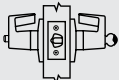
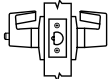
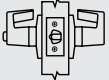
PDQ Functions

| FUNCTION | FUNCTION NUMBER | INSIDE OUTSIDE | DESCRIPTION | ANSI NUMBER |
|----------------------------|-----------------|---|---|-------------|
| NON KEYED | | | | |
| Exit | GT124 |  | <ul style="list-style-type: none"> Latchbolt operated by inside lever at all times Outside lever always fixed Outside lever has non-removable security features | F89 |
| Communicating | GT125 |  | <ul style="list-style-type: none"> Latchbolt operated by inside lever Blank plate outside Minimum clearance of 1-1/2" between doors Frame depth 7-1/8" | — |
| Passage / Closet | GT126™ |  | <ul style="list-style-type: none"> Latchbolt operated by lever from either side at all times | F75 |
| Time Out Lock | GT173 |  | <ul style="list-style-type: none"> Latchbolt by lever from either side unless push button on outside is depressed. Lock returns to passage mode upon release of push button. Inside lever locked only when pushing button on outside lever. Inside lever unlocked by emergency release of button from outside.  | — |
| Hospital Privacy | GT175 |  | <ul style="list-style-type: none"> Latchbolt operated by lever from either side or emergency turn piece in outside lever Outside lever locked by push button on inside Outside lever unlocked by emergency turn piece from outside, rotating inside lever, or closing door | — |
| Privacy Bedroom / Bathroom | GT176™ |  | <ul style="list-style-type: none"> Latchbolt operated by lever from either side or emergency release in outside lever Outside lever locked by push button on inside Outside lever unlocked by emergency release from outside, rotating inside lever, or closing door | F76 |
| Patio | GT177 |  | <ul style="list-style-type: none"> Latchbolt operated by lever from either side Outside lever locked by push button on inside Outside lever unlocked by rotating inside lever, or closing door Outside lever has non-removable security features | F77 |
| Double Dummy | GT205 |  | <ul style="list-style-type: none"> Pull lever both sides No mechanical operation | — |
| Single Dummy | GT211 |  | <ul style="list-style-type: none"> Pull lever one side No mechanical operation | — |

GT SERIES
CYLINDRICAL LOCKS

 INDICATES RIGID LEVER

PDQ Functions





GT SERIES
CYLINDRICAL LOCKS

| FUNCTION | FUNCTION NUMBER | INSIDE OUTSIDE | DESCRIPTION | ANSI NUMBER |
|-------------------------------|-----------------|------------------|--|-------------|
| KEYED | | | | |
| Storeroom | GT115 | | <ul style="list-style-type: none"> Latchbolt operated by inside lever or key in outside lever Outside lever always fixed | F86 |
| Entrance | GT116 | | <ul style="list-style-type: none"> Latchbolt operated by lever from either side or key in outside lever Outside lever locked by push/turn button on inside When outside lever is locked by push button on inside – key from outside, or rotating inside lever unlocks outside lever When outside lever is locked by pushing and turning button on the inside, key from outside or rotating inside lever retracts latch but does not unlock outside lever | F109 |
| Security | GT120 | | <ul style="list-style-type: none"> Latchbolt operated by lever from either side Key on outside locks inside lever Key on outside unlocks inside lever Outside keyed lever always free Inside lever has non-removable security features | — |
| Utility Asylum / Institution | GT128 | | <ul style="list-style-type: none"> Both levers rigid Latchbolt retracted by key on both sides Can only gain entry or exit by key | F87 |
| Exit or Twin Communicating | GT129 | | <ul style="list-style-type: none"> Latchbolt operated by key in inside lever Inside lever always fixed Blank plate outside Minimum clearance of 1-1/2" between doors Frame depth 7-1/8" | — |
| Vestibule Class Room Security | GT135 | | <ul style="list-style-type: none"> Latchbolt operated by lever from either side Key in either lever locks outside lever Key in either lever unlocks outside lever Inside lever always free | F110 |
| Vestibule Class Room Security | GT135LED | | <ul style="list-style-type: none"> Latchbolt operated by lever from either side Key in either lever locks outside lever Key in either lever unlocks outside lever Inside lever always free Red LED Outside Lever Status Indicator Lock Directional Arrow Patent # 9,187,928 | F110 |
| Store Door | GT137 | | <ul style="list-style-type: none"> Latchbolt operated by lever from either side Both levers locked by key from either side Both levers unlocked by key from either side | F91 |
| Communicating | GT141 | | <ul style="list-style-type: none"> Latchbolt operated by lever from either side Key in either side locks or unlocks its own lever independently | F80 |
| Vestibule Class Room Security | GT145 | | <ul style="list-style-type: none"> Latchbolt operated by lever from either side Key in either lever locks outside lever Key in either lever unlocks outside lever Inside lever always free Lock Directional Arrow | F110 |

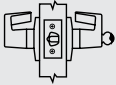

INDICATES RIGID LEVER

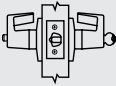
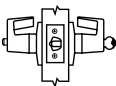
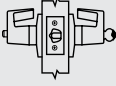
PDQ Functions

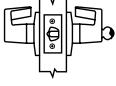
| FUNCTION | FUNCTION NUMBER | INSIDE OUTSIDE | DESCRIPTION | ANSI NUMBER |
|----------------------------|---|---|---|-------------|
| KEYED | | | | |
| Classroom | GT148 |  | <ul style="list-style-type: none"> Latchbolt operated by lever from either side Outside lever locked by key from outside Outside lever unlocked by key from outside Inside lever always operates latch | F84 |
| Exit or Twin Communicating | GT150 |  | <ul style="list-style-type: none"> Latchbolt operated by inside lever Blank plate outside Inside lever locked by key inside Inside lever unlocked by key inside Minimum clearance of 1-1/2" between doors Use only in rooms with more than one exit Frame depth 7-1/8" | — |
| Service Station | GT155 |  | <ul style="list-style-type: none"> Latchbolt operated by lever from either side or key in outside lever Outside lever locked by push button on inside When outside lever is locked by push button on inside – key from outside, rotating inside lever, or closing door unlocks outside lever When outside lever is locked by pushing and turning the slotted button on the inside, key from outside or rotating inside lever retracts latch but does not unlock outside lever | F92 |
| Dormitory / Corridor | GT165 |  | <ul style="list-style-type: none"> Latchbolt operated by lever from either side or key in outside lever Outside lever locked by key on outside or push button on inside Outside lever unlocked by key in outside lever, closing door, or rotating inside lever Inside lever always free | F90 |
| Entry | GT182 |  | <ul style="list-style-type: none"> Latchbolt operated by lever from either side or key in outside lever Outside lever locked by push button on inside Outside lever unlocked by key from outside | F82 |
| Electrified Storeroom |  GT199A |  | <ul style="list-style-type: none"> Key outside retracts latchbolt Latchbolt operated by lever from inside Auxiliary latch deadlocks latchbolt Fail safe—latchbolt operated by lever from outside unless electrically locked Fail secure—latchbolt operated by lever from outside when electrically unlocked Accepts 12VDC@.6A, 12VAC@.6A, 24VDC@.3A and 24VAC@.3A Furnished with 6" wire leads | — |

GT SERIES
CYLINDRICAL LOCKS

Cross Reference

| ANSI # / FUNCTION | PDQ | BEST | CORBIN | DORMA | FALCON T SERIES | HAGER | MARKS 95 SERIES | SARGENT | SCHLAGE | YALE |
|---|--|---------|--------|-------|-----------------|-------|-----------------|---------|---------|--------|
| F75 PASSAGE | GT 126 | 93K N | CL3510 | C810 | 101 | 3410 | N | 10U15 | ND10S | 5401LN |
| F76 PRIVACY | GT 176 | 93K L | CL3520 | C840 | 301 | 3440 | L | 10U65 | ND40S | 5402LN |
| F82 ENTRY | GT 182 | 93K A | CL3561 | C850 | 501 | 3450 | A | 10G24 | ND50PD | 5404LN |
| F109 ENTRANCE | GT 116 | 93K AB | CL3551 | C853 | N/A | 3453 | N/A | 10G05 | ND53PD | 5404LN |
| F84 CLASSROOM | GT 148 | 93K R | CL3555 | C870 | 561 | 3470 | S | 10G37 | ND70PD | 5408LN |
| F86 STORE ROOM | GT 115 | 93K D | CL3557 | C880 | 581 | 3480 | F | 10G04 | ND80PD | 5405LN |
| F90 CORRIDOR | GT 165 | 93K KT | N/A | C873 | 571 | 3473 | T | 10G54 | ND73PD | 5422LN |
| F110 INTRUDER CLASSROOM | GT 135 | 93K IN | N/A | C877 | 381 | 3495 | DB | 10G38 | ND95PD | 5418LN |
| F110 INTRUDER CLASSROOM W/LED INDICATOR | GT 135 LED PDQ Exclusive - Patent #9,187,928 | N/A | N/A | N/A | N/A | N/A | N/A | N/A | N/A | N/A |
| SINGLE DUMMY | GT 211 | 93K 1DT | CL3550 | C801 | 12 | 3417 | DO | 10U93 | ND170 | 5455LN |

GT SERIES
CYLINDRICAL LOCKS

Lever Cross Reference

| PDQ | BEST | CORBIN | DORMA | FALCON | HAGER | MARKS | SARGENT | SCHLAGE | YALE |
|--------------------|------|--------|-------|--------|-------|-------|---------|---------|------|
| PHL — PHILADELPHIA | 15 | NZD | LR | D | WTS | 195 | L Lever | RHO | AU |
| BOSTON — BSN | 14 | PZD | LC | Q | ARC | 295 | P Lever | SPA | PB |
| MIAMI — MIA | 16 | AZD | LG | A | AUS | 495 | B Lever | ATH | MO |



PHILADELPHIA — PHL



BOSTON — BSN



MIAMI — MIA

Information on this sheet is compiled from public documents and third parties. As a result, PDQ makes no guarantees as to their accuracy, content, quality or availability. Comparisons were made using the technical features only and are not commercial comparisons. Final suitability should be determined by a professional hardware consultant.

 **ALL LEVERS**

Typical Applications

- Apartments
- Back-of-House Hotel/Motel
- Commercial Buildings
- Government Buildings
- High Traffic Areas
- Healthcare
- Houses of Worship
- Military Barracks
- Retail Backroom
- Retrofit/Repair/Replacement

Features

- UL listed for 3-hour fire door
- Exceeds ANSI/BHMA A156.2 Grade 1
- 5 standard functions
- Various strike and latch options to accommodate any opening
- Available in keyways of most major manufacturers
- Tactile abrasive coating option
- Antimicrobial coating option
- Five (5) year limited warranty

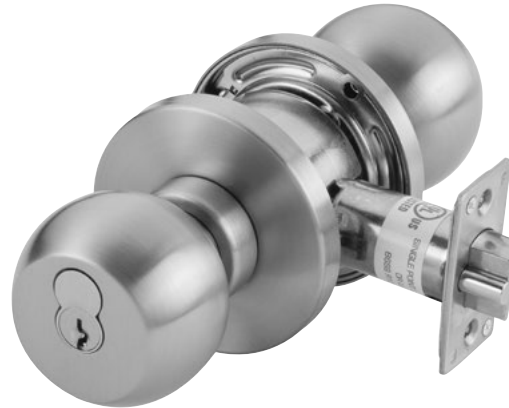





Specifications



| | |
|---|---|
| FOR DOORS: | • 1-3/8" to 2" thick. |
| DOOR PREP: | • Fits Standard 160 or 161 Door Prep. |
| BACKSET: | • 2-3/8", 2-3/4", 3-3/4", 5". |
| CASE: | • Steel, Yellow Chromate Plate |
| FRONT: | • 2-1/4" x 1-1/8" or 2-1/4" x 1" • Stainless Steel or Wrought Bronze. |
| STRIKE: | • 4-7/8" x 1-1/4" (ASA). "T" or "FL" Strike Optional. • Stainless Steel or Wrought Bronze. |
| UL F LATCHBOLT: | • 3 hours of fire testing qualified, stainless steel latch bolt. |
| ROSE: | • 3" DIA Wrought. |
| HAND: | • Non-handed. |
| TRIM: | • CQ ball knob. Stainless steel or wrought brass. |
| KEYWAYS: | • Available in keyways of most major manufacturers. |
| CYLINDER: | • Supplied standard to accommodate SFIC core. (Cylinder not included). • Standard High Security and UL437 Cylinders Available |
| KEYING: | • Standard core is available and can be MK, CMK, GMK, or CK. Available Zero Bitted (KO), Keyed Different (KD), Keyed Alike (KA). Can be keyed into existing masterkey systems of other manufacturers. |
| FINISHES: | • 630 (US32D) |
| WARRANTY: | • Five (5) Year Limited Warranty |
| CERTIFICATIONS, LISTINGS, COMPLIANCES: | • Meets ANSI/BHMA A156.2–2003 Grade 1, surpassed 800,000 cycles • UL/CUL 10C listed for 3 hrs, for single doors up to 4'0" x 8'0" • TAA compliant. Country of origin: Taiwan |

‡ Available with antimicrobial coating, technology that is known to inhibit the growth of microbes.

PDQ Functions

| FUNCTION | FUNCTION NUMBER | INSIDE OUTSIDE | DESCRIPTION | ANSI NUMBER |
|------------------|-----------------|---|---|-------------|
| NON KEYED | | | | |
| Passage | 126 |  | <ul style="list-style-type: none"> Latchbolt operated by both knobs | F75 |
| Privacy Bathroom | 176 |  | <ul style="list-style-type: none"> Latchbolt operated by both knobs Push button in inside knob locks outside knob Inside knob or closing door releases button Emergency opening from outside | F76 |
| KEYED | | | | |
| Storeroom | 115 |  | <ul style="list-style-type: none"> Latchbolt operated from outside by key, inside by knob Outside knob is rigid at all times Inside knob always free for immediate exit Deadlocking (guarded) latchbolt | F86 |
| Entrance | 116 |  | <ul style="list-style-type: none"> Latchbolt operated by both knobs Outside knob locked or unlocked by turn/push button Inside knob always free Pushing and turning button locks outside knob requiring use of key until button is manually unlocked Pushing button only locks outside knob until unlocked with key or inside knob is turned | F109 |
| Classroom | 148 |  | <ul style="list-style-type: none"> Latchbolt operated from outside by knob except when locked from outside by key Latchbolt operated from inside by knob at all times Deadlocking (guarded) latchbolt | F84 |



How to Order



| QUANTITY | SERIES | FUNCTION | KNOB | FINISH | BACKSET | STRIKE | CYLINDER | KEYWAY | KEYING | OPTION |
|---|--------|----------|------|--------|--|---|--|--------|---|----------------|
| 20 | SX | 116 | CQ | 630 | 234 | ASA | D | SCC | KD | — |
| <p>NOTE: Case quantity is 10 / Case weight is 32 lbs. Keyed Functions / Case weight is 40 lbs. Non-Keyed Functions / For split finishes, designate O/S trim first, then I/S</p> | | | | | | | PAGE 60 | | <p>DB — Dust Box AM — Antimicrobial Coating</p> | |
| | | | | | <p>234 — 2-3/4" 238 — 2-3/8" 334 — 3-3/4" 5 — 5"</p> | <p>ASA — ANSI/ASA (default) FL — Full Lip T — "T" Strike</p> | <p>D Default L Less Cylinder SF6 Lock is SFIC prepped w/ 6 pin core SF7 Lock is SFIC prepped w/ 7 pin core SFL Lock is SFIC prepped but less core SFC Lock is SFIC prepped w/ construction core SFP Lock is SFIC prepped w/ plastic construction core</p> | | | |
| | | | | | PAGE 59 | PAGE 60 | | | | PAGE 61 |

Locksets

| ANSI NO. | FUNCTION | DESCRIPTION | 630 |
|---|----------|-------------------|----------|
| <i>NON-CYLINDER</i> | | | |
| F75 | 126 | Passage | \$220.00 |
| F76 | 176 | Privacy | \$265.00 |
| <i>SINGLE CYLINDER</i> | | | |
| F86 | 115 | Storeroom | \$285.00 |
| F109 | 116 | Entrance | |
| F84 | 148 | Classroom/Storage | |
| <p>List prices shown include conventional key in knob/lever cylinder. For I-C, list prices do not include core.</p> | | | |

| CYLINDER OPTIONS | ICON | LOCK ADJUSTMENT |
|------------------|---|-----------------|
| D |  | N/C |
| SFL |  | |

Trim



NOTES:

- Locks will be furnished with 2-3/4" Latchbolt, ASA Strike & SCC Keyway unless otherwise stated
- 2-3/4" Latchbolt will be furnished with 2-1/4" x 1-1/8" faceplate unless otherwise stated

Backset

| CODE | DESCRIPTION | LOCK ADJUSTMENT |
|-----------------------|---------------------------|-----------------|
| 2-3/4" BACKSET | | |
| 234 | 2-1/4" x 1-1/8" | N/C |
| 234F | 2-1/4" x 1" | |
| 234FR | 2-1/4" x 1" x 1/4" Radius | |
| 2-3/8" BACKSET | | |
| 238F | 2-1/4" x 1-1/8" | N/C |
| 238 | 2-1/4" x 1" | |
| 238R | 2-1/4" x 1" x 1/4" Radius | |
| 3-3/4" BACKSET | | |
| 334F | 2-1/4" x 1-1/8" | \$18.00 |
| 334 | 2-1/4" x 1" | |
| 334R | 2-1/4" x 1" x 1/4" Radius | |
| 5" BACKSET | | |
| 5 | 2-1/4" x 1-1/8" | \$24.00 |
| 5F | 2-1/4" x 1" | |
| 5FR | 2-1/4" x 1" x 1/4" Radius | |



Latchbolt



Deadlatch

Strikes

| | CODE | DESCRIPTION | LOCK ADJUSTMENT |
|---|------|---|-----------------|
|  | ASA | ASA Strike 1-1/4" x 4-7/8" 630 (US32D) Stainless Steel | N/C |
|  | T | T-Strike 1-1/8" x 2-3/4" 630 (US32D) Stainless Steel | |
|  | FL | Full Lip Strike 1-5/8" x 2-1/4" (US32D) Stainless Steel | |

NOTES:

- Specify desired finish for Strikes & Latchbolts if ordered separately

Keyways and Cylinders

| PDQ KEYWAY | COMPATIBLE WITH | SOLD WITH LOCK | |
|--|---|----------------|---------------|
| AR1 | Arrow / AR1 | N/C | |
| CO59A1 | Corbin / 59A1 | | |
| CO6 | Corbin / 60 | | |
| CL4 | Corbin / L4 | | |
| RUD | Russwin / D1 | | |
| SCE | Schlage / E | | |
| SCC | Schlage / C | | |
| SCC-K | Schlage / C-K | | |
| SAL | Sargent / LA | | |
| RA-RC | Sargent / RA-RC | | |
| YA8 | Yale / E1R | | |
| GA | Yale / GA | | |
| FAL | Falcon / E-R | | |
| KW | Kwikset | | |
| TA | PDQ / TA (Restricted. Limited to Grandmaster systems w/4 masters) | | |
| Dummy | — | | |
| T-Turn | — | | |
| L | Less Cylinder | | Deduct \$4.00 |
| HIGH SECURITY CYLINDERS AND CORES | | | |
| SEE HIGH SECURITY CYLINDERS AND CORES SECTION, PAGE 118. | | | |

- NOTES:
- Specify finish for cylinders ordered separately
 - Kwikset cylinder available in 5 pin only
 - Specify KD, KA4, or 1 bitted
 - 6 pin cylinder keyed for 5 pin



Key in Knob/Lever Cylinder

SX SERIES
CYLINDRICAL LOCKS

Cores and Keyways

| DESCRIPTION | PDQ NO. | ADD |
|---|------------------|---------|
| SMALL FORMAT UNCOMBINATED | | |
| 6 Pin Cores | I5206 + KEYWAY | \$40.00 |
| 7 Pin Cores | I5207 + KEYWAY | |
| COMBINATED | | |
| 6 Pin Cores | I5206-1 + KEYWAY | \$60.00 |
| 7 Pin Cores | I5207-1 + KEYWAY | |
| BEST[™] Compatible | | |
| A (DEFAULT), B, C, D, E, F, G, H, J, K, L, M, Q, | | |
| WA, WB, WC, WG, WH, TB, TD, TE, & R | | |
| PDQ Exclusive | | |
| PDQ1, PDQ2 | | |
| PDQ Exclusive and Restricted | | |
| PDQ3 | | |
| SFIC CONSTRUCTION | | |
| Construction Core 6-pin only | | \$60.00 |
| Dummy Construction Core Plastic | | \$8.00 |
| HIGH SECURITY IC CORES | | |
| SEE HIGH SECURITY CYLINDERS AND CORES SECTION, PAGE 118. — LFIC REQUIRES LARGE FORMAT LEVER | | |

- NOTES:
- Specify finish for IC Cores ordered separately
 - Control keys must be ordered separately
 - **PDQ1, PDQ2, PDQ3 (Restricted)**, Best A2 & A4 Systems Available

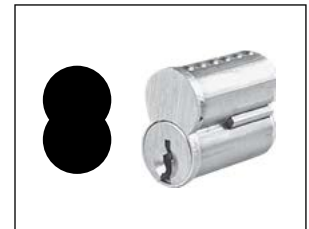

SFL/SFIC Core



UL 437 and High Security Cylinders





Options

| CODE | DESCRIPTION | LOCK ADJUSTMENT |
|-----------|---|-----------------|
| DB | Dust Box | \$8.00 |
| AM | Antimicrobial Coating, Knob Set Includes Inside and Outside Knob and Rose | \$37.00 |

Backset

| CODE | TYPE | FACEPLATE | CORNERS | PDQ NUMBER | LIST PRICE | |
|--|-------------|-----------------|------------------|-------------|------------|--|
| 2-3/4" BACKSET | | | | | | |
| 234F | SPRINGLATCH | 2-1/4" X 1 | SQUARE | V21900-714 | \$68.00 | |
| 234 | | 2-1/4" X 1-1/8" | SQUARE (DEFAULT) | V21900-712 | | |
| 234F | DEADLATCH | 2-1/4" X 1 | SQUARE | V21900-713 | | |
| 234 | | 2-1/4" X 1-1/8" | SQUARE (DEFAULT) | V21900-711 | | |
| 2-3/8" BACKSET | | | | | | |
| 238 | SPRINGLATCH | 2-1/4" X 1 | SQUARE (DEFAULT) | V21900-722 | | |
| 238F | | 2-1/4" X 1-1/8" | SQUARE | V21900-724 | | |
| 238R | | 2-1/4" X 1 | 1/4" RADIUS | V21900-722R | | |
| 238 | DEADLATCH | 2-1/4" X 1 | SQUARE (DEFAULT) | V21900-721 | | |
| 238F | | 2-1/4" X 1-1/8" | SQUARE | V21900-723 | | |
| 238R | | 2-1/4" X 1 | 1/4" RADIUS | V21900-721R | | |
| 3-3/4" BACKSET EXTENSION | | | | | | |
| Extension for 2-3/8" latch (sold separately) to make 3-3/4" Backset. | | | | V21903 | \$55.00 | |
| 5" BACKSET EXTENSION | | | | | | |
| Extension for 2-3/4" latch (sold separately) to make 5" Backset. | | | | V21902 | \$58.00 | |

Strikes

| | CODE | DESCRIPTION | 630 | LIST PRICE |
|---|------|--|------------|------------|
|  | ASA | ASA Strike (any finish) 1-1/4" x 4-7/8" | V91900-1 | \$38.00 |
|  | T | T-Strike (any finish) 1-1/8" x 2-3/4" | V91901-1 | \$17.00 |
|  | FL | Full Lip Strike (any finish) 1-5/8" x 2-1/4" | V919010-1 | \$14.00 |
| | | MOUNTING SCREW PACK | X91910 | \$12.00 |
|  | | LATCHBOLT — 2-3/4" DEADLOCKING 2-1/4" X 1-1/8" | I04521-1 | \$130.00 |
|  | | LATCHBOLT — 2-3/8" DEADLOCKING 2-1/4" X 1-1/8" | V91904-721 | \$115.00 |

Durability and Reliability

PDQ's Grade 2 mechanical lock offering includes a range of features, functions, and styles as well as a commitment to deliver durability, convenience, and unmatched value for a wide range of projects and applications.

GP Mechanical



Applications

Heavy-duty performance for high-traffic interior and exterior applications including offices, hospitality, assisted living, church, and other high/medium duty commercial applications. Strong like an ox, over 3x BHMA abusive lever torque test standard.

SD Mechanical

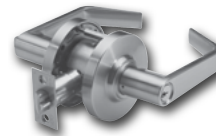

Applications

Built to offer tough and reliable performance at a competitive price. Applications include multi-family, offices, hospitality, assisted living, and other standard duty commercial applications.

CL Interconnected Mechanical



Applications

Offers the security of a deadbolt and lever combined in one product. Applications include hospitality, assisted living, multi-family, offices and retail.

SF Mechanical



Applications

Built to offer tough and reliable performance at a competitive price. Applications include multi-family, offices, hospitality, assisted living, and other standard duty commercial applications.



ASSEMBLED
IN THE USA

Typical Applications

- Government Facilities
- Healthcare
- Higher Education
- Hospitality
- Houses of Worship
- Industrial
- K-12 Education
- Multi-family
- Offices
- Public Buildings



Specifications



| | |
|---|--|
| FOR DOORS: | • 1-3/8" to 1-3/4" thick • Preset for 1-3/4" door |
| APPLICATION: | • Through door thru-bolting • Fits 160 and 161 Door prep |
| BACKSET: | • 2-3/4" standard • 2-3/8", 5" optional |
| CHASSIS: | • Heavy duty diecast, investment cast, cold rolled steel, stainless steel mechanism |
| FRONT: | • 2-1/4" x 1-1/8" or 2-1/4" x 1" • Stainless Steel or Wrought Brass • Beveled 1/8" on 2" |
| STRIKE: | • ASA standard • Stainless Steel or Wrought Brass • T-Strike or Full Lip Strike optional |
| LEVERS: | Philadelphia (SFL and LFL), Boston (SFL), Miami (SFL) |
| ROSE: | • 3-3/8" DIA Wrought |
| LATCHBOLT: | • 1/2" Throw |
| HAND: | • Non-handed |
| TRIM: | • Solid diecast PHL, BSN or MIA Levers • 65° Lever Rotation • Wrought Brass Roses • Concealed Screws |
| KEYS: | • Two (2) per Lock |
| KEYWAYS: | • SCC standard (Schlage C Compatible) • Compatible with Best, Falcon and Arrow small format IC cores |
| INTERCHANGEABLE CORE: | • Available for all keyed functions • Large Format IC Core available for PHL Lever ONLY. • 6 or 7-pin • Compatible with Best, Falcon & Arrow |
| CYLINDER: | • 6-pin Brass Insert Cylinder keyed to 5-pins • Standard High Security and UL437 Cylinders Available |
| KEYING: | • Options: MK, CMK or GMK • Zero Bitted (KO), Keyed Different (KD) or Keyed Alike (KA) Can be keyed into existing master key systems |
| FINISHES: | • 605 (US3), 606 (US4), 612 (US10), 613E, 619 (US15), 622 (US19), 625 (US26), 626 (US26D) • Optional Antimicrobial Coating Available with 626 finish only |
| CERTIFICATIONS, LISTINGS, COMPLIANCES: | • UL listed for 3 hrs, for single doors up to 4'0" x 8'0" • Certified to ANSI/BHMA 156.2, Grade 2 • Complies with ADA (Americans with Disabilities Act) and ICC/ANSI 117.1 for Accessible and Usable Buildings |
| WARRANTY: | • Eight (8) Year Limited Warranty |
| COUNTRY OF ORIGIN: | • Assembled in the U.S.A. with U.S. and foreign material. • Meets requirements of the Buy American Act as a COTS product manufactured in the United States. |

† Available with antimicrobial coating, technology that is known to inhibit the growth of microbes.

How to Order

| QUANTITY | SERIES | FUNCTION | LEVER | FINISH | BACKSET | STRIKE | CYLINDER | KEYWAY | KEYING | OPTION |
|----------|--------|----------|-------|--------|---------|----------------|---|---------|--------|---|
| 6 | GP | 116 | PHL | 626 | 234 | ASA | D | SCC | KD | — |
| | | | BSN | 605 | 234 — | ASA — | D Default | PAGE 67 | | TC1IS — Tactile Abrasive Coating - Inside only |
| | | | MIA | 606 | 2-3/4" | ANSI/ASA | L Less Cylinder | | | |
| | | | PHL | 612 | 238 — | ASA (default) | SF6 Lock is SFIC prepped w/ 6 pin core | | | TC1OS — Tactile Abrasive Coating - Outside only |
| | | | | 613E | 334 — | FL — | SF7 Lock is SFIC prepped w/ 7 pin core | | | TC2 — Tactile Abrasive Coating - Both Sides |
| | | | | 622 | 3-3/4" | Full Lip | SFL Lock is SFIC prepped but less core | | | SF — Split Finishes |
| | | | | 625 | 5 — | T — "T" Strike | SFC Lock is SFIC prepped w/ construction core | | | LL — Lead-Lined Rose |
| | | | | 626 | 5 — | | SFP Lock is SFIC prepped w/ plastic construction core | | | DB — Dust Box |
| | | | | | | | LF6 Lock is Schlage LFIC prepped w/ Schlage core | | | AM — Antimicrobial Coating |
| | | | | | | | LFL Lock is Schlage LFIC prepped but less core | | | |
| | | | | | | | LFC Lock is Schlage LFIC prepped w/ construction core | | | |
| | | | | | | PAGE 66 | PAGE 67 | PAGE 68 | | |

NOTE: Case quantity is 6 / Case weight is 30 lbs. Keyed Functions / Case weight is 29 lbs. Non-Keyed Functions / For split finishes, designate O/S trim first, then I/S

Locksets - Standard and Interchangeable Cores

| ANSI NO. | FUNCTION | DESCRIPTION | 626 | 605/606/612 613E/619/622/625 |
|------------------------|----------|---------------------------|----------|---------------------------------|
| NON-CYLINDER | | | | |
| | 125 | Communicating | \$186.00 | \$208.00 |
| F75 | 126 | Passage | | |
| F76 | 176 | Privacy | \$217.00 | \$239.00 |
| SINGLE CYLINDER | | | | |
| F86 | 115 | Store Room | \$234.00 | \$256.00 |
| F109 | 116 | Entrance | | |
| F84 | 148 | Classroom | | |
| | 150 | Exit / Twin Communicating | | |
| F82 | 182 | Office / Entry | | |
| DUMMY | | | | |
| | 205 | Double Dummy | \$142.00 | \$164.00 |
| | 211 | Single Dummy | \$81.00 | \$92.00 |

List prices shown include cylinder.

| CYLINDER OPTIONS | ICON | LOCK ADJUSTMENT |
|------------------|------|-----------------|
| D | | |
| SFL | | N/C |
| LFL* | | |

IC Core not included see page 67 for core option

LFL prep only available in PHL lever and 613E, 622, 626 finish.

Trim/Levers



ALL LEVERS

NOTES:

- Locks will be furnished with 2-3/4" Latchbolt, ASA Strike & SCC Keyway unless otherwise stated
- 2-3/4" Latchbolt will be furnished with 2-1/4" x 1-1/8" faceplate unless otherwise stated
- 2-3/8" Latchbolt will be furnished with 2-1/4" x 1" faceplate unless otherwise stated
- Split finishes priced at the highest finish price

Backset

| CODE | DESCRIPTION | LOCK ADJUSTMENT |
|------|---------------------------|-----------------|
| | 2-3/4" BACKSET | N/C |
| 234 | 2-1/4" x 1-1/8" | |
| 234F | 2-1/4" x 1" | |
| | 2-3/8" BACKSET | |
| 238F | 2-1/4" x 1-1/8" | \$5.00 |
| 238 | 2-1/4" x 1" | |
| 238R | 2-1/4" x 1" x 1/4" Radius | |
| | 3-3/4" BACKSET | \$18.00 |
| 334F | 2-1/4" x 1-1/8" | |
| 334 | 2-1/4" x 1" | |
| 334R | 2-1/4" x 1" x 1/4" Radius | |
| | 5" BACKSET | \$24.00 |
| 5 | 2-1/4" x 1-1/8" | |
| 5F | 2-1/4" x 1" | |
| 5FR | 2-1/4" x 1" x 1/4" Radius | |



Strikes

| | CODE | DESCRIPTION | LOCK ADJUSTMENT |
|---|------|--|-----------------|
|  | ASA | ASA Strike (any finish) 1-1/4" x 4-7/8" | N/C |
|  | T | T-Strike (any finish) 1-1/8" x 2-3/4" | |
|  | FL | Full Lip Strike (any finish) 1-5/8" x 2-1/4" | |

NOTES:

- Specify finish for Strikes & Latchbolts if ordered separately

Keyways and Cylinders

| PDQ KEYWAY | COMPATIBLE WITH | SOLD WITH LOCK | |
|---|---|----------------|---------------|
| AR1 | Arrow / AR1 | N/C | |
| CO59A1 | Corbin / 59A1 | | |
| CO6 | Corbin / 60 | | |
| CL4 | Corbin / L4 | | |
| RUD | Russwin / D1 | | |
| SCE | Schlage / E | | |
| SCC | Schlage / C | | |
| SCC-K | Schlage / C-K | | |
| SAL | Sargent / LA | | |
| RA-RC | Sargent / RA-RC | | |
| YA8 | Yale / EIR | | |
| GA | Yale / GA | | |
| FAL | Falcon / E-R | | |
| KW | Kwikset | | |
| TA | PDQ / TA (Restricted. Limited to Grandmaster systems w/4 masters) | | |
| Dummy | — | | |
| T-Turn | — | | |
| L | Less Cylinder | | Deduct \$4.00 |
| HIGH SECURITY CYLINDERS AND CORES | | | |
| SEE HIGH SECURITY CYLINDERS AND CORES SECTION, PAGE 118 | | | |

NOTES:

- Specify finish for cylinders ordered separately
- Kwikset cylinder available in 5 pin only
- Specify KD, KA4, or 1 bitted
- 6 pin cylinder keyed for 5 pin

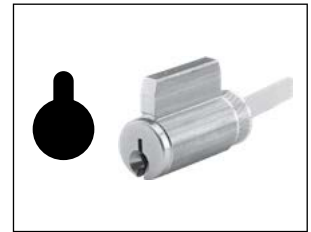

Key in Knob/Lever Cylinder



UL 437 and High Security Cylinders

Cores and Keyways

| DESCRIPTION | PDQ NO. | ADD |
|--|------------------|---------|
| SMALL FORMAT UNCOMBINED | | |
| 6 Pin Cores | I5206 + KEYWAY | \$40.00 |
| 7 Pin Cores | I5207 + KEYWAY | |
| COMBINED | | |
| 6 Pin Cores | I5206-1 + KEYWAY | \$60.00 |
| 7 Pin Cores | I5207-1 + KEYWAY | |
| BEST[®] Compatible | | |
| A (DEFAULT), B, C, D, E, F, G, H, J, K, L, M, Q, WA, WB, WC, WG, WH, TB, TD, TE, & R | | |
| PDQ Exclusive | | |
| PDQ1, PDQ2 | | |
| PDQ Exclusive and Restricted | | |
| PDQ3 | | |
| SFIC CONSTRUCTION | | |
| Construction Core 6-pin only | | \$60.00 |
| Dummy Construction Core Plastic | | \$8.00 |
| LFIC CONSTRUCTION | | |
| Construction Core 6-pin only. Construction cores are invoiced at shipment and credited upon return. | | \$70.00 |
| IC Tailpiece Assembly | | \$10.00 |
| LFIC COMBINED | | |
| Schlage compatible LFIC, SCC (Schlage C compatible) keyway | | \$70.00 |
| PDQ TA LFIC Restricted | | |
| LFIC UNCOMBINED | | |
| Schlage compatible LFIC, SCC (Schlage C compatible) keyway | | \$50.00 |
| HIGH SECURITY IC CORES | | |
| SEE HIGH SECURITY CYLINDERS AND CORES SECTION, PAGE 118. — LFIC REQUIRES LARGE FORMAT LEVER | | |

NOTES:

- Combined cores include master keying in the list price
- Specify finish for IC Cores ordered separately
- Control keys must be ordered separately
- **PDQ1, PDQ2, PDQ3 (Restricted)**, Best A2 & A4 Systems Available

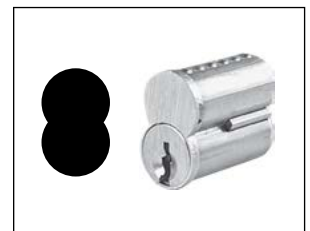

SFL/SFIC Core





LFL/LFIC Schlage Format

Options







| CODE | DESCRIPTION | LOCK ADJUSTMENT |
|--------------|--|---------------------|
| TC1IS | Tactile Abrasive Coating - Inside only | \$26.00 |
| TC1OS | Tactile Abrasive Coating - Outside only | |
| TC2 | Tactile Abrasive Coating - Both Sides | \$52.00 |
| SF | Split Finishes | Higher Finish Price |
| LL | Lead-Lined Rose | \$214.00 |
| DB | Dust Box | \$8.00 |
| AM | Antimicrobial Coating, Lever Set Includes Inside and Outside Lever and Rose (Available with 626 finish only) | \$40.00 |

| CODE | TYPE | FACEPLATE | CORNERS | PDQ NUMBER | LIST PRICE | |
|--|-------------|-----------------|------------------|-------------|------------|--|
| 2-3/4" BACKSET | | | | | | |
| 234F | SPRINGLATCH | 2-1/4" X 1 | SQUARE | V21900-714 | \$68.00 | |
| 234 | | 2-1/4" X 1-1/8" | SQUARE (DEFAULT) | V21900-712 | | |
| 234F | DEADLATCH | 2-1/4" X 1 | SQUARE | V21900-713 | | |
| 234 | | 2-1/4" X 1-1/8" | SQUARE (DEFAULT) | V21900-711 | | |
| 2-3/8" BACKSET | | | | | | |
| 238 | SPRINGLATCH | 2-1/4" X 1 | SQUARE (DEFAULT) | V21900-722 | | |
| 238F | | 2-1/4" X 1-1/8" | SQUARE | V21900-724 | | |
| 238R | | 2-1/4" X 1 | 1/4" RADIUS | V21900-722R | | |
| 238 | DEADLATCH | 2-1/4" X 1 | SQUARE (DEFAULT) | V21900-721 | | |
| 238F | | 2-1/4" X 1-1/8" | SQUARE | V21900-723 | | |
| 238R | | 2-1/4" X 1 | 1/4" RADIUS | V21900-721R | | |
| 3-3/4" BACKSET EXTENSION | | | | | | |
| Extension for 2-3/8" latch (sold separately) to make 3-3/4" Backset. | | | | V21903 | \$55.00 | |
| 5" BACKSET EXTENSION | | | | | | |
| Extension for 2-3/4" latch (sold separately) to make 5" Backset. | | | | V21902 | | |

Strikes

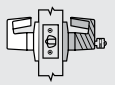
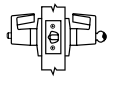
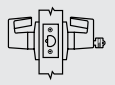
| | CODE | DESCRIPTION | 605 | 613E | 622 | 630 | LIST PRICE |
|---|------|--|-----------|-----------|-----------|-----------|------------|
|  | ASA | ASA Strike (any finish) 1-1/4" x 4-7/8" | V91900-5 | V91900-6 | V91900-H | V91900-1 | \$38.00 |
|  | T | T-Strike (any finish) 1-1/8" x 2-3/4" | V91901-5 | V91901-6 | V91901-H | V91901-1 | \$17.00 |
|  | FL | Full Lip Strike (any finish) 1-5/8" x 2-1/4" | V919010-5 | V919010-6 | V919010-H | V919010-1 | \$14.00 |

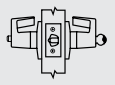
PDQ Functions

| FUNCTION | FUNCTION NUMBER | INSIDE OUTSIDE | DESCRIPTION | ANSI NUMBER |
|----------------------------|-----------------|---|--|-------------|
| NON KEYED | | | | |
| Communicating | GP125 |  | <ul style="list-style-type: none"> Latchbolt operated by inside lever Blank plate outside Minimum clearance of 1-1/2" between doors Frame depth 7-1/8" Deadlocking (guarded) latchbolt | — |
| Passage | GP126 |  | <ul style="list-style-type: none"> Latchbolt operated by lever from either side at all times | F75 |
| Privacy Bedroom Bathroom | GP176 |  | <ul style="list-style-type: none"> Latchbolt operated by lever from either side or emergency release in outside lever Outside lever locked by push button on inside Outside lever unlocked by emergency release from outside, rotating inside lever, or closing door | F76 |
| KEYED | | | | |
| Storeroom | GP115 |  | <ul style="list-style-type: none"> Latchbolt operated by inside lever or key in outside lever Outside lever always fixed | F86 |
| Entrance | GP116 |  | <ul style="list-style-type: none"> Latchbolt operated by lever from either side or key in outside lever Outside lever locked by push/turn button on inside When outside lever is locked by push button on inside – key from outside, or rotating inside lever unlocks outside lever When outside lever is locked by pushing and turning button on the inside, key from outside or rotating inside lever retracts latch but does not unlock outside lever | F109 |
| Classroom | GP148 |  | <ul style="list-style-type: none"> Latchbolt operated by lever from either side Outside lever locked by key from outside Outside lever unlocked by key from outside Inside lever always operates latch | F84 |
| Exit or Twin Communicating | GP150 |  | <ul style="list-style-type: none"> Latchbolt operated by inside lever Blank plate outside Inside lever locked by key inside Inside lever unlocked by key inside Minimum clearance of 1-1/2" between doors Use only in rooms with more than one exit Frame depth 7-1/8" | — |
| Entry | GP182 |  | <ul style="list-style-type: none"> Latchbolt operated by lever from either side or key in outside lever Outside lever locked by push button on inside Outside lever unlocked by key from outside, and rotating inside lever | F82 |
| DUMMY | | | | |
| Double Dummy | GP205 |  | <ul style="list-style-type: none"> Pull lever both sides No mechanical operation | — |
| Single Dummy | GP211 |  | <ul style="list-style-type: none"> Pull lever one side No mechanical operation | — |

GP SERIES
CYLINDRICAL LOCKS



INDICATES RIGID LEVER

Cross Reference

| ANSI # / FUNCTION | PDQ | ARROW | BEST | CORBIN | DORMA | FALCON | K2 | SARGENT | SCHLAGE | YALE |
|-------------------|--------|-------|------|--------|-------|--------|--------|---------|---------|--------|
| F75 PASSAGE | GP 126 | ML01 | 73K | CL3810 | CL710 | B101 | QCL230 | 7U15 | AL10 | 5301LN |
| F76 PRIVACY | GP 176 | ML02 | 73K | CL3820 | CL740 | B301 | QCL240 | 7U65 | AL40 | 5303LN |
| F82 ENTRY | GP 182 | NA | 73K | CL3861 | CL750 | B501 | NA | NA | AL50 | 5302LN |
| F109 ENTRANCE | GP 116 | ML11 | 73K | CL3851 | CL753 | B511 | QCL250 | 7G05 | AL53 | 5307LN |
| F84 CLASSROOM | GP 148 | ML17 | 73K | CL3855 | CL770 | B561 | QCL260 | 7G37 | AL70 | 5308LN |
| F86 STORE ROOM | GP 115 | ML12 | 73K | CL3857 | CL780 | B581 | QCL270 | 7G04 | AL80 | 5305LN |
| SINGLE DUMMY | GP 211 | ML08 | 73K | CL3850 | CL701 | B12 | QCL220 | 7U93 | AL170 | 5328LN |

Lever Comparison

| PDQ | ARROW | BEST | CORBIN | DORMA | FALCON | K2 | SARGENT | SCHLAGE | YALE |
|--------------------|-------|------|--------|-------|--------|-----|---------|---------|------|
| MIAMI — MIA | VR | 16 | AZD | LG | NA | SLA | B | JUP | MO |
| PHILADELPHIA — PHL | BRR | 15 | NZD | LR | D | PNN | L | SAT | AU |
| BOSTON — BSN | SR | 14 | PZD | LC | Q | PEA | P | NEP | PB |



PHILADELPHIA — PHL



BOSTON — BSN



MIAMI — MIA

Information on this sheet is compiled from public documents and third parties. As a result, PDQ makes no guarantees as to their accuracy, content, quality or availability. Comparisons were made using the technical features only and are not commercial comparisons. Final suitability should be determined by a professional hardware consultant.



Typical Applications

- Assisted Living
- Hospitality
- Houses of Worship
- Industrial
- Medium/Light Commercial Installations
- Multi-family
- Offices
- Retail

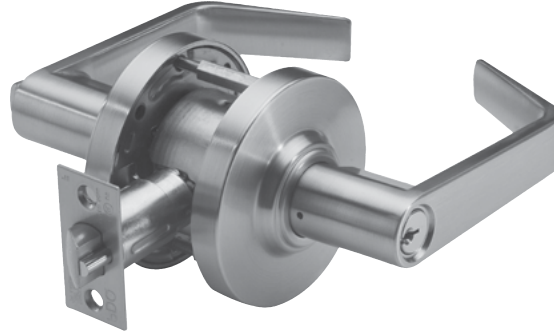

Specifications



| | |
|---|--|
| FOR DOORS: | • 1-3/8" to 1-3/4" thick • Preset for 1-3/4" door |
| APPLICATION: | • Through door thru-bolting • Fits standard 160 and 161 Door prep • Thru-Bolts are removable |
| BACKSET: | • 2-3/4" standard • 2-3/8", 3-3/4", 5" optional |
| CHASSIS: | • Heavy-gauge cold rolled steel mechanism • Dichromated for corrosion resistance |
| FRONT: | • 2-1/4" x 1-1/8" or 2-1/4" x 1" • Stainless Steel or Wrought Brass |
| STRIKE: | • ASA standard • T-Strike or Full Lip Strike optional • Stainless Steel or Wrought Brass |
| LEVERS: | • Philadelphia, Boston, Miami, Memphis, Orlando |
| ROSE: | • 3-3/8" DIA Wrought |
| LATCHBOLT: | • 1/2" Throw |
| HAND: | • Non-handed (Except Memphis) |
| TRIM: | • Solid diecast PHL, BSN, MIA, MEM and ORL Levers • Wrought Brass Roses • Concealed Screws |
| KEYS: | • Two (2) per Lock |
| KEYWAYS: | • SCC standard (Schlage C Compatible) • Also available in keyways of other manufacturers |
| INTERCHANGEABLE CORE: | • 6 or 7-pin • Compatible with Best, Falcon & Arrow. Not available with Memphis lever. |
| CYLINDER: | • 6-pin Brass Insert Cylinder keyed to 5-pins • Standard High Security and UL437 Cylinders Available |
| KEYING: | • Options: MK, CMK or GMK / Zero Bitted (KO), Keyed Different (KD) or Keyed Alike (KA) • Can be keyed into existing master key systems |
| FINISHES: | • 605 (US3), 613E, 622 (US19), 626 (US26D) † |
| CERTIFICATIONS, LISTINGS, COMPLIANCES: | • UL listed for 3 hrs, for single doors up to 4'0" x 8'0" • Certified to ANSI/BHMA A156.2 Grade 2 • Complies with ADA (Americans with Disabilities Act) and ICC/ANSI 117.1 for Accessible and Usable Buildings • TAA compliant. Country of origin: KR |
| WARRANTY: | • Five (5) year Limited Warranty |

† Available with antimicrobial coating, technology that is known to inhibit the growth of microbes.

SD SERIES

LIST PRICE

Effective July 3, 2023

How to Order

| QUANTITY | SERIES | FUNCTION | LEVER | FINISH | BACKSET | STRIKE | CYLINDER | KEYWAY | KEYING | OPTION |
|---|--------|----------|-------|--------|---------|----------|--------------------|------------------|--------|---------------------|
| 10 | SD | 116 | PHL | 626 | 234 | ASA | D | SCC | KD | — |
| NOTE: Case quantity is 10 / Case weight is 37 lbs. *Memphis keyed and dummy functions only. | | | BSN | 605 | 234 — | ASA — | D Default | PAGE 75 | | SF — Split Finishes |
| | | | MIA | 613E | 2-3/4" | ANSI/ | L Less Cylinder | | | DB — Dust Box |
| | | | PHL | 622 | 238 — | ASA (de- | SF6 Lock is SFIC | | | |
| | | | MEM | 626 | 2-3/8" | fault) | prepped w/ 6 pin | | | |
| | | | ORL | 626 | 334 — | FL — | core | | | |
| | | | | | | 5 — 5" | Full Lip | SF7 Lock is SFIC | | |
| | | | | | | | T — | prepped w/ 7 pin | | |
| | | | | | | | "T" Strike | core | | |
| | | | | | | | SFL Lock is SFIC | | | |
| | | | | | | | prepped but less | | | |
| | | | | | | | core | | | |
| | | | | | | | SFC Lock is SFIC | | | |
| | | | | | | | prepped w/ | | | |
| | | | | | | | construction core | | | |
| | | | | | | | SFP Lock is SFIC | | | |
| | | | | | | | prepped w/ plastic | | | |
| | | | | | | | construction core | | | |
| | | | | | | PAGE 74 | PAGE 75 | | | PAGE 76 |

Locksets

| ANSI NO. | FUNCTION | DESCRIPTION | 626 | 605, 613E, 622 |
|--|----------|---------------|----------|----------------|
| NON-CYLINDER | | | | |
| | 125 | Communicating | \$118.00 | \$127.00 |
| F75 | 126 | Passage | | |
| F76 | 176 | Privacy | \$122.00 | \$131.00 |
| SINGLE CYLINDER | | | | |
| F86 | 115 | Store Room | \$128.00 | \$137.00 |
| F109 | 116 | Entrance | | |
| F84 | 148 | Classroom | | |
| F82 | 182 | Entry | | |
| DUMMY | | | | |
| | 211 | Single Dummy | \$64.00 | \$69.00 |
| List prices shown include cylinder. | | | | |

| CORE OPTIONS | ICON | LOCK ADJUSTMENT |
|--------------|------|-----------------|
| D | | N/C |
| SFL | | N/C |

IC Core not included see page 75 for core options.

NOTES:

- Locks will be furnished with 2-3/4" Latchbolt, ASA Strike & SCC Cylinder unless otherwise stated
- 2-3/4" Latchbolt will be furnished with 2-1/4" x 1-1/8" faceplate unless otherwise stated
- 2-3/8" Latchbolt will be furnished with 2-1/4" x 1" faceplate unless otherwise stated

SD SERIES
CYLINDRICAL LOCKS

Trim/Levers



PHILADELPHIA — PHL



BOSTON — BSN



MIAMI — MIA



MEMPHIS — MEM

(Specify handing)



ORLANDO - ORL



ALL LEVERS



| CODE | DESCRIPTION | LOCK ADJUSTMENT |
|-----------------------|---------------------------|-----------------|
| 2-3/4" BACKSET | | |
| 234 | 2-1/4" x 1-1/8" | N/C |
| 234F | 2-1/4" x 1" | |
| 234FR | 2-1/4" x 1" x 1/4" Radius | \$5 |
| 2-3/8" BACKSET | | |
| 238F | 2-1/4" x 1-1/8" | N/C |
| 238 | 2-1/4" x 1" | |
| 238R | 2-1/4" x 1" x 1/4" Radius | \$5 |
| 3-3/4" BACKSET | | |
| 334F | 2-1/4" x 1-1/8" | \$18 |
| 334 | 2-1/4" x 1" | |
| 334R | 2-1/4" x 1" x 1/4" Radius | |
| 5" BACKSET | | |
| 5 | 2-1/4" x 1-1/8" | \$24 |
| 5F | 2-1/4" x 1" | |
| 5FR | 2-1/4" x 1" x 1/4" Radius | |



Strikes

| | CODE | DESCRIPTION | LOCK ADJUSTMENT |
|---|------|--|-----------------|
|  | ASA | ASA Strike (any finish) 1-1/4" x 4-7/8" | N/C |
|  | T | T-Strike (any finish) 1-1/8" x 2-3/4" | |
|  | FL | Full Lip Strike (any finish) 1-5/8" x 2-1/4" | |

NOTES:
 • Specify finish for Strikes & Latchbolts if ordered separately

Keyways and Cylinders

| PDQ KEYWAY | COMPATIBLE WITH | SOLD WITH LOCK |
|---|---|----------------|
| AR1 | Arrow / AR1 | N/C |
| CO59A1 | Corbin / 59A1 | |
| CO6 | Corbin / 60 | |
| CL4 | Corbin / L4 | |
| RUD | Russwin / D1 | |
| SCE | Schlage / E | |
| SCC | Schlage / C | |
| SCC-K | Schlage / C-K | |
| SAL | Sargent / LA | |
| RA-RC | Sargent / RA-RC | |
| YA8 | Yale / E1R | |
| GA | Yale / GA | |
| FAL | Falcon / E-R | |
| KW | Kwikset | |
| TA | PDQ / TA (Restricted. Limited to Grandmaster systems w/4 masters) | |
| Dummy | — | |
| T-Turn | — | |
| L | Less Cylinder | |
| HIGH SECURITY CYLINDERS AND CORES | | |
| SEE HIGH SECURITY CYLINDERS AND CORES SECTION, PAGE 118 | | |

- NOTES:**
- Specify finish for cylinders ordered separately
 - Kwikset cylinder available in 5 pin only
 - Specify KD, KA4, or 1 bitted
 - 6 pin cylinder keyed for 5 pin



Key in Knob/Lever Cylinder



UL 437 and High Security Cylinders

Cores and Keyways

| DESCRIPTION | PDQ NO. | ADD |
|--|------------------|---------|
| SMALL FORMAT UNCOMBINED | | |
| 6 Pin Cores | I5206 + KEYWAY | \$40.00 |
| 7 Pin Cores | I5207 + KEYWAY | |
| COMBINED | | |
| 6 Pin Cores | I5206-1 + KEYWAY | \$60.00 |
| 7 Pin Cores | I5207-1 + KEYWAY | |
| BEST Compatible | | |
| A (DEFAULT), B, C, D, E, F, G, H, J, K, L, M, Q, WA, WB, WC, WG, WH, TB, TD, TE, & R | | |
| PDQ Exclusive | | |
| PDQ1, PDQ2 | | |
| PDQ Exclusive and Restricted | | |
| PDQ3 | | |
| SFIC CONSTRUCTION | | |
| Construction Core 6-pin only | | \$60.00 |
| Dummy Construction Core Plastic | | \$8.00 |
| LFIC CONSTRUCTION | | |
| Construction Core 6-pin only | | \$70.00 |
| IC Tailpiece Assembly Construction cores are invoiced at shipment and credited upon return. | | \$10.00 |
| HIGH SECURITY IC CORES | | |
| SEE HIGH SECURITY CYLINDERS AND CORES SECTION, PAGE 118 | | |

- NOTES:**
- Specify finish for IC Cores ordered separately
 - Control keys must be ordered separately
 - **PDQ1, PDQ2, PDQ3 (Restricted)**, Best A2 & A4 Systems Available

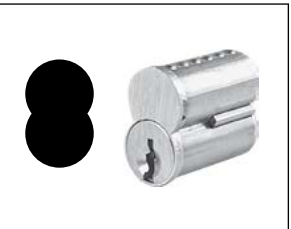

SFL/SFIC Core



Options

| CODE | DESCRIPTION | LOCK ADJUSTMENT |
|------|----------------|-----------------|
| SF | Split Finishes | \$8.00 |
| DB | Dust Box | \$8.00 |









Backset

| CODE | TYPE | FACEPLATE | CORNERS | PDQ NUMBER | LIST PRICE | |
|--|-------------|-----------------|------------------|-------------|------------|--|
| 2-3/4" BACKSET | | | | | | |
| 234F | SPRINGLATCH | 2-1/4" X 1 | SQUARE | V21900-714 | \$68.00 | |
| 234 | | 2-1/4" X 1-1/8" | SQUARE (DEFAULT) | V21900-712 | | |
| 234F | DEADLATCH | 2-1/4" X 1 | SQUARE | V21900-713 | | |
| 234 | | 2-1/4" X 1-1/8" | SQUARE (DEFAULT) | V21900-711 | | |
| 2-3/8" BACKSET | | | | | | |
| 238 | SPRINGLATCH | 2-1/4" X 1 | SQUARE (DEFAULT) | V21900-722 | | |
| 238F | | 2-1/4" X 1-1/8" | SQUARE | V21900-724 | | |
| 238R | | 2-1/4" X 1 | 1/4" RADIUS | V21900-722R | | |
| 238 | DEADLATCH | 2-1/4" X 1 | SQUARE (DEFAULT) | V21900-721 | | |
| 238F | | 2-1/4" X 1-1/8" | SQUARE | V21900-723 | | |
| 238R | | 2-1/4" X 1 | 1/4" RADIUS | V21900-721R | | |
| 3-3/4" BACKSET EXTENSION | | | | | | |
| Extension for 2-3/8" latch (sold separately) to make 3-3/4" Backset. | | | | V21903 | \$55.00 | |
| 5" BACKSET EXTENSION | | | | | | |
| Extension for 2-3/8" latch (sold separately) to make 5" Backset. | | | | V21902 | | |

Strikes

| | CODE | DESCRIPTION | 605 | 613E | 622 | 630 | LIST PRICE |
|---|------|--|-----------|-----------|-----------|-----------|------------|
|  | ASA | ASA Strike (any finish) 1-1/4" x 4-7/8" | V91900-5 | V91900-6 | V91900-H | V91900-1 | \$38.00 |
|  | T | T-Strike (any finish) 1-1/8" x 2-3/4" | V91901-5 | V91901-6 | V91901-H | V91901-1 | \$17.00 |
|  | FL | Full Lip Strike (any finish) 1-5/8" x 2-1/4" | V919010-5 | V919010-6 | V919010-H | V919010-1 | \$14.00 |

PDQ Functions

| FUNCTION | FUNCTION NUMBER | INSIDE OUTSIDE | DESCRIPTION | ANSI NUMBER |
|--------------------------------|-----------------|---|---|-------------|
| NON KEYED | | | | |
| Communicating | SD125 |  | <ul style="list-style-type: none"> Latchbolt operated by inside lever Blank plate outside Minimum clearance of 1-1/2" between doors Deadlocking (guarded) latchbolt | — |
| Passage | SD126 |  | <ul style="list-style-type: none"> Latchbolt operated by lever from either side at all times | F75 |
| Privacy Bedroom Bathroom | SD176 |  | <ul style="list-style-type: none"> Latchbolt operated by lever from either side or emergency release in outside lever Outside lever locked by push button on inside Outside lever unlocked by emergency release from outside, rotating inside lever, or closing door | F76 |
| KEYED | | | | |
| Storeroom | SD115 |  | <ul style="list-style-type: none"> Latchbolt operated from outside by key, inside by lever Outside lever always fixed Inside lever always free Deadlocking (guarded) latchbolt | F86 |
| Entrance | SD116 |  | <ul style="list-style-type: none"> Latchbolt operated by lever from either side or key in outside lever Outside lever locked by push/turn button on inside When outside lever is locked by push button on inside – key from outside, or rotating inside lever unlocks outside lever When outside lever is locked by pushing and turning the button on the inside, key from outside or rotating inside lever retracts latch but does not unlock outside lever Deadlocking (guarded) latchbolt | F109 |
| Classroom | SD148 |  | <ul style="list-style-type: none"> Latchbolt operated by lever from either side Outside lever locked or unlocked by key from outside Inside lever always operates latch Deadlocking (guarded) latchbolt | F84 |
| Entry | SD182 |  | <ul style="list-style-type: none"> Latchbolt operated by lever from either side or key in outside lever Outside lever locked by push button on inside Outside lever unlocked by key from outside, and rotating inside lever | F82 |
| DUMMY | | | | |
| Single Dummy | SD211 |  | <ul style="list-style-type: none"> Pull lever one side No mechanical operation | — |



INDICATES RIGID LEVER

Cross Reference

| ANSI # / FUNCTION | PDQ | ARROW | CAL ROYAL | CORBIN | DORMA | FALCON | HAGER | SARGENT | YALE |
|-------------------|--------|-------|-----------|--------|-------|--------|-------|---------|--------|
| F75 PASSAGE | SD 126 | RL01 | SL30 | CL3710 | C510 | W101 | 2510 | 6U15 | 4601LN |
| F76 PRIVACY | SD 176 | RL02 | SL20 | CL3720 | C540 | W301 | 2540 | 6U65 | 4602LN |
| F109 ENTRANCE | SD 116 | RL11 | SL01 | CL3751 | C553 | W511 | 2553 | 65G37 | 4607LN |
| F84 CLASSROOM | SD 148 | RL17 | SL03 | CL3755 | C570 | W561 | 2570 | 6G37 | 4608LN |
| F86 STORE ROOM | SD 115 | RL12 | SL05 | CL3759 | C580 | W581 | 2580 | 6G04 | 4605LN |
| SINGLE DUMMY | SD 211 | RL08 | SL40 | CL3750 | C501 | W12 | 2517 | 6U93 | 4655LN |

Lever Cross Reference

| PDQ | ARROW | CAL ROYAL | CORBIN | DORMA | FALCON | HAGER | SARGENT | YALE |
|--------------------|-------|-----------|--------|-------|--------|-------|---------|------|
| MIAMI — MIA | | AG | AZD | LG | | | B | MO |
| PHILADELPHIA — PHL | BRR | GN | NZD | LR | D | WTS | L | AU |
| BOSTON — BSN | SR | SPA | PZD | LC | Q | ARC | P | PB |
| MEMPHIS — MEM | | | | | | | | |
| ORLANDO — ORL | | | | | | | | |



PHILADELPHIA — PHL



BOSTON — BSN



MIAMI — MIA



MEMPHIS — MEM
(SPECIFY HANDING)



ORLANDO — ORL

Information on this sheet is compiled from public documents and third parties. As a result, PDQ makes no guarantees as to their accuracy, content, quality or availability. Comparisons were made using the technical features only and are not commercial comparisons. Final suitability should be determined by a professional hardware consultant.



Reliable Security for Multi-Family, Multi-Tenant and Light Commercial Applications.

- 5 functions - Privacy, Passage, Entrance Storeroom plus Single Dummy
- Heavier duty cylindrical lock is more durable than a tubular lock
- 5 designer levers to choose from
- 7 architectural finishes
- Stylish 2-9/16" round rose and 2-15/16" square rose
- Retrofits all major manufacturer's door preps
- Adjustable 2-3/8" – 2-3/4" backset latch is standard.
- Optional fixed backset latch adds fire label and BHMA certification.
- Conventional and SFIC core cylinders.
- Anti-lockout kick-off feature (Privacy)
- Suitable for doors 1-3/8" – 1-3/4" thick
- Shares common levers with SD Cylindrical and CL Interconnected locks. Mix and match for a uniform look.



Applications



MULTI-FAMILY HOUSING



SENIOR LIVING



STUDENT HOUSING



LIGHT COMMERCIAL

Specifications



| | |
|---|---|
| FOR DOORS: | • 1-3/8" to 1-3/4" thick • Preset for 1-3/4" door |
| APPLICATION: | • Fits standard 160 and 161 door prep • No additional thru-bolt |
| BACKSET: | • Adjustable - 2-3/8" - 2-3/4" (Optional UL Listed fire latch has fixed backsets, 2-3/8" or 2-3/4") |
| CHASSIS: | • Heavy-gauge cold rolled steel mechanism • Dichromated for corrosion resistance |
| FRONT: | • 1" face width, 1/4" radius with square corner filler for 1-1/8" width. |
| STRIKE: | • Full Lip Strike standard, ASA and T-Strike optional |
| LEVERS: | • Philadelphia, Boston, Miami, Memphis and Orlando |
| ROSE: | • 2-9/16" Diameter Round Rose, 2-15/16" Square Rose |
| LATCHBOLT: | • Adjustable - 2-3/8" - 2-3/4" latch standard for Non-Keyed functions, with optional UL fire-rated 2-3/4" or 2-3/8" fixed backset. • Fixed backset 2-3/8" or 2-3/4" latchbolt standard for Keyed functions. |
| HAND: | • Non-handed |
| TRIM: | • Solid diecast PHL, BSN, MIA, MEM and ORL levers • Wrought brass roses • Concealed screws |
| KEYS: | • Two (2) per Lock |
| KEYWAYS: | • SCC standard (Schlage C Compatible) • Also available in keyways of other manufacturers |
| INTERCHANGEABLE CORE: | • 6 or 7-pin • Compatible with Best, Falcon & Arrow. Not available with Memphis lever. |
| CYLINDER: | • 6-pin Brass Insert Cylinder keyed to 5-pins • Standard High Security and UL437 Cylinders Available |
| KEYING: | • Options: MK, CMK or GMK / Zero Bitted (KO), Keyed Different (KD) or Keyed Alike (KA) • Can be keyed into existing master key systems |
| FINISHES: | • 605 (US3), 606 (US4), 613E, 619 (US15), 622 (US19), 625 (US26), 626 (US26D) |
| CERTIFICATIONS, LISTINGS, COMPLIANCES: | • Entry function and optional fixed backset latch only. – Certified to ANSI/BHMA 156.2, Grade 2 (fixed backset latch only). – UL listed for single doors up to 4'0" x 8'0" when ordered with UL latchbolt, contact factory for details. • Complies with ADA (Americans with Disabilities Act) and ICC/ANSI 117.1 for Accessible and Usable Buildings • TAA compliant. Country of origin: KR |
| WARRANTY: | • Three (3) year Limited Warranty |

SF SERIES

LIST PRICE

How to Order - Non-Keyed Functions

Effective July 3, 2023

| SERIES | FUNCTION | LEVER | ROSE | FINISH | LATCH | STRIKE | OPTION |
|--------|--------------------|-------|---|--------|---|-------------------------|---------------------|
| SF | 126 | PHL | — | 626 | ADJ | FL | — |
| | 126 — Passage | BSN | BLANK — Round Rose (default) All Levers | 605 | ADJ* — Non-Fire Rated 1" face width, 1/4" radius corner with 1-1/8" square corner filler. | FL — Full Lip (default) | SF — Split Finishes |
| | 176 — Privacy | MIA | | 606 | 234** — Fire Rated Fixed 2-3/4" backset fire rated latch, Square Corner 1-1/8" face | ASA — ANSI/ASA | |
| | 211 — Single Dummy | MEM* | | 613E | 238** — Fire Rated Fixed 2-3/8" backset fire rated latch, Square Corner 1" face | T — "T" Strike | |
| | | ORL | SR — Square Rose (All Levers) | 619 | 238R** — Fire Rated Fixed 2-3/8" backset fire rated latch, Radius Corner 1" face | | |
| | | PHL | | 622 | | | |
| | | | 625 | | | | |
| | | | 626 | | | | |
| | | | | | | PAGE 82 | PAGE 82 |

*ADJ latch is standard.

**Optional fixed backset latch adds fire label and BHMA Certification.

How to Order - Keyed Functions

| SERIES | FUNCTION | LEVER | ROSE | FINISH | LATCH | STRIKE | CYLINDER | KEYWAY | KEYING | OPTION |
|--------|-----------------|-------|---|--------|--|---|---|---------|--------|---------------------|
| SF | 116 | PHL | — | 626 | 234 | FL | D | SCC | KD | — |
| | 115 — Storeroom | BSN | BLANK — Round Rose (default) All Levers | 605 | 234* — Fire Rated Fixed 2-3/4" backset fire rated latch, Square Corner 1-1/8" face | FL — Full Lip (default) | D Default | PAGE 83 | | SF — Split Finishes |
| | 116 — Entrance | MIA | | 606 | 238* — Fire Rated Fixed 2-3/8" backset fire rated latch, Square Corner 1" face | L Less Cylinder | SF6 Lock is SFIC prepped w/ 6 pin core | | | |
| | | MEM** | | 613E | 238R* — Fire Rated Fixed 2-3/8" backset fire rated latch, Radius Corner 1" face | ASA — ANSI/ASA | SF7 Lock is SFIC prepped w/ 7 pin core | | | |
| | | ORL | SR — Square Rose (All Levers) | 619 | | T — "T" Strike | SFL Lock is SFIC prepped but less core | | | |
| | | PHL | | 622 | | | SFC Lock is SFIC prepped w/ construction core | | | |
| | | | 625 | | | SFP Lock is SFIC prepped w/ plastic construction core | | | | |
| | | | 626 | | | | | | | |
| | | | | | | PAGE 82 | PAGE 83 | | | PAGE 82 |

*Fire rated, fixed backset latch is standard on keyed functions.

**Memphis not available w/SFIC

Locksets

| ANSI NO. | FUNCTION | DESCRIPTION | 626/619 | 605, 606, 613E, 622, 625 |
|-------------------------------------|----------|--------------|----------|--------------------------|
| NON-CYLINDER | | | | |
| F75 | 126 | Passage | \$88.00 | \$96 |
| F76 | 176 | Privacy | \$92.00 | \$100.00 |
| SINGLE CYLINDER | | | | |
| F86 | 115 | Store Room | \$124.00 | \$132.00 |
| F109 | 116 | Entrance | | |
| DUMMY | | | | |
| | 211 | Single Dummy | \$44.00 | \$48.00 |
| List prices shown include cylinder. | | | | |

Rose Trim

| CODE | DESCRIPTION | LOCK ADJUSTMENT |
|------|--|-----------------|
| — | Round Rose | N/C |
| SR | Square Rose (Function 211) | \$10.00 |
| | Square Rose (Function 115,116,126,176) | \$20.00 |



ROUND ROSE



SQUARE ROSE

SF SERIES
CYLINDRICAL LOCKS

Levers



PHILADELPHIA



BOSTON



MIAMI



MEMPHIS



ORLANDO

| CYLINDER OPTIONS | ICON | LOCK ADJUSTMENT |
|------------------|------|-----------------|
| D | | N/C |
| SFL | | |

IC Core not included see page 83 for core options.



Non-Fire Rated Adjustable Latch (Standard on Non-Keyed Functions)

| CODE | DESCRIPTION | LOCK ADJUSTMENT |
|------|---|-----------------|
| ADJ | Adjustable non-fire rated latch, 1" face width with 1/4" radius corner with 1-1/8" square corner filler | N/C |
| 234 | Fixed 2-3/4" backset fire rated latch, Square Corner 1-1/8" face | \$9.00 |
| 238 | Fixed 2-3/8" backset fire rated latch, Square Corner 1" face | |
| 238R | Fixed 2-3/8" backset fire rated latch, Radius Corner 1" face | |



Non-Fire Rated Adjustable Latch

UL Fire Rated Fixed Backset Option for Non-Keyed Functions*

| CODE | DESCRIPTION | LOCK ADJUSTMENT |
|------|--|-----------------|
| 234 | Fixed 2-3/4" backset fire rated latch, Square Corner 1-1/8" face | N/C |
| 238 | Fixed 2-3/8" backset fire rated latch, Square Corner 1" face | \$9.00 |
| 238R | Fixed 2-3/8" backset fire rated latch, Radius Corner 1" face | |



Fire Rated Fixed Latch

*Standard on Keyed Functions, BHMA Certified.

Strikes

| | CODE | DESCRIPTION | LOCK ADJUSTMENT |
|---|------|--|-----------------|
|  | ASA | ASA Strike (any finish) 1-1/4" x 4-7/8" | N/C |
|  | T | T-Strike (any finish) 1-1/8" x 2-3/4" | |
|  | FL | Full Lip Strike (any finish) 1-5/8" x 2-1/4" | |

NOTES:

- Specify finish for Strikes & Latchbolts if ordered separately

Options

| CODE | DESCRIPTION | LOCK ADJUSTMENT |
|------|--|-----------------|
| SF | Split Finishes (Added to highest finish price) | \$8.00 |

Strike Parts

| | CODE | DESCRIPTION | 605 | 613E | 619 | 622 | 625 | 630 | PART LIST PRICE |
|---|------|--|-----------|-----------|-----------|-----------|-----------|-----------|-----------------|
|  | ASA | ASA Strike (any finish) 1-1/4" x 4-7/8" | V91900-5 | V91900-6 | V91900-E | V91900-H | V91900-2 | V91900-1 | \$38.00 |
|  | T | T-Strike (any finish) 1-1/8" x 2-3/4" | V91901-5 | V91901-6 | V91901-E | V91901-H | V91901-2 | V91901-1 | \$17.00 |
|  | FL | Full Lip Strike (any finish) 1-5/8" x 2-1/4" | V919010-5 | V919010-6 | V919010-E | V919010-H | V919010-2 | V919010-1 | \$14.00 |

Cylinders

| PDQ KEYWAY | COMPATIBLE WITH | SOLD WITH LOCK | |
|---|---|----------------|---------------|
| AR1 | Arrow / AR1 | N/C | |
| CO59A1 | Corbin / 59A1 | | |
| CO6 | Corbin / 60 | | |
| CL4 | Corbin / L4 | | |
| RUD | Russwin / D1 | | |
| SCE | Schlage / E | | |
| SCC | Schlage / C | | |
| SCC-K | Schlage / C-K | | |
| SAL | Sargent / LA | | |
| RA-RC | Sargent / RA-RC | | |
| YA8 | Yale / E1R | | |
| GA | Yale / GA | | |
| FAL | Falcon / E-R | | |
| KW | Kwikset | | |
| TA | PDQ / TA (Restricted. Limited to Grandmaster systems w/4 masters) | | |
| Dummy | — | | |
| T-Turn | — | | |
| L | Less Cylinder | | Deduct \$4.00 |
| HIGH SECURITY CYLINDERS AND CORES | | | |
| SEE HIGH SECURITY CYLINDERS AND CORES SECTION, PAGE 118 | | | |

NOTES:

- Specify finish for cylinders ordered separately
- Kwikset cylinder available in 5 pin only
- Specify KD, KA4, or 1 bitted
- 6 pin cylinder keyed for 5 pin



Key in Knob/Lever Cylinder



UL 437 and High Security Cylinders

Cores and Keyways

| DESCRIPTION | PDQ NO. | ADD |
|--|------------------|---------|
| SMALL FORMAT UNCOMBINATED | | |
| 6 Pin Cores | I5206 + KEYWAY | \$40.00 |
| 7 Pin Cores | I5207 + KEYWAY | |
| COMBINATED | | |
| 6 Pin Cores | I5206-1 + KEYWAY | \$60.00 |
| 7 Pin Cores | I5207-1 + KEYWAY | |
| BEST™ Compatible | | |
| A (DEFAULT), B, C, D, E, F, G, H, J, K, L, M, Q, WA, WB, WC, WG, WH, TB, TD, TE, & R | | |
| PDQ Exclusive | | |
| PDQ1, PDQ2 | | |
| PDQ Exclusive and Restricted | | |
| PDQ3 | | |
| SFIC CONSTRUCTION | | |
| Construction Core 6-pin only | | \$60.00 |
| Dummy Construction Core Plastic | | \$8.00 |
| HIGH SECURITY IC CORES | | |
| SEE HIGH SECURITY CYLINDERS AND CORES SECTION, PAGE 118. | | |



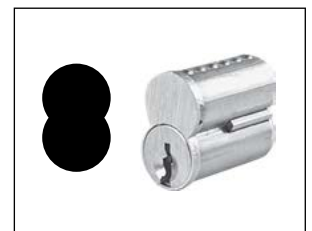

NOTES:

- Specify finish for IC Cores ordered separately
- Control keys must be ordered separately
- **PDQ1, PDQ2, PDQ3 (Restricted)**, Best A2 & A4 Systems Available



SFL/SFIC Core

PDQ Functions

| FUNCTION | FUNCTION NUMBER | INSIDE OUTSIDE | DESCRIPTION | ANSI NUMBER |
|--------------------------|-----------------|--|---|-------------|
| NON KEYED | | | | |
| Passage | SF126 |  | <ul style="list-style-type: none"> Latchbolt operated by lever from either side at all times | F75 |
| Privacy Bedroom Bathroom | SF176 |  | <ul style="list-style-type: none"> Latchbolt operated by lever from either side or emergency release in outside lever Outside lever locked by push button on inside Outside lever unlocked by emergency release from outside, rotating inside lever, or closing door | F76 |
| KEYED | | | | |
| Storeroom | SF115 |  <p>Fixed backset, fire rated, BHMA latch included.</p> | <ul style="list-style-type: none"> Latchbolt operated from outside by key, inside by lever Outside lever always fixed Inside lever always free Deadlocking (guarded) latchbolt | F86 |
| Entrance | SF116 |  <p>Fixed backset, fire rated, BHMA latch included.</p> | <ul style="list-style-type: none"> Latchbolt operated by lever from either side or key in outside lever Outside lever locked by push/turn button on inside When outside lever is locked by push button on inside – key from outside, or rotating inside lever unlocks outside lever When outside lever is locked by pushing and turning the button on the inside, key from outside or rotating inside lever retracts latch but does not unlock outside lever Deadlocking (guarded) latchbolt | F109 |
| DUMMY | | | | |
| Single Dummy | SF211 |  | <ul style="list-style-type: none"> Pull lever one side No mechanical operation | — |



INDICATES RIGID LEVER

Lever Cross Reference

| PDQ | ARROW | CORBIN | DORMA | FALCON | HAGER | SARGENT | SCHLAGE | YALE |
|--------------------|-------|--------|-------|--------|-------|---------|---------|------|
| MIAMI — MIA | | AZD | LG | | | B | JAZ | MO |
| PHILADELPHIA — PHL | BRR | NZD | LR | D | WTS | L | ELA | AU |
| BOSTON — BSN | SR | PZD | LC | Q | ARC | P | | PB |
| MEM — MEMPHIS | | | | | | | | |
| ORL — ORLANDO | | | | | | | LAT | |



PHILADELPHIA — PHL



BOSTON — BSN



MIAMI — MIA



MEMPHIS — MEM



ORLANDO — ORL



ALL LEVERS

Information on this sheet is compiled from public documents and third parties. As a result, PDQ makes no guarantees as to their accuracy, content, quality or availability. Comparisons were made using the technical features only and are not commercial comparisons. Final suitability should be determined by a professional hardware consultant.

Typical Applications

- Assisted Living
- Hospitality
- Military Housing
- Multi-family
- Offices
- Retail



ADA COMPLIANT



Specifications

| | |
|---|--|
| FOR DOORS: | • 1-3/8" and 1-3/4" thick. |
| PREPARATION: | • ANSI/BHMA A156.115 for 4" and 5-1/2" hole centers, field selectable. |
| DUST BOX: | • Included for Latchbolt and Deadbolt. |
| LATCHBOLT BACKSET: | • 2-3/8" or 2-3/4" (Default). Specify when ordering |
| DEADBOLT BACKSET: | • Field adjustable for 2-3/8" and 2-3/4" (Default). |
| STRIKE: | • "T"-Strike (Default) • ASA or Full-Lip optional |
| LEVERS: | • Boston, Miami, Memphis, Orlando, Philadelphia |
| ROSE: | • 2-3/8" Round Rose, 2-15/16" Square Rose |
| INSIDE ESCUTCHEON: | • 3-3/4"W x 9-3/4"H (Wrought) |
| LATCHBOLT: | • 1/2" Throw |
| DEADBOLT: | • 1" Throw • Brass Bolt containing one 1/4" case-hardened Steel Roll Pin |
| HANDING: | • Non-handed (Except for Memphis Lever) |
| KEYS: | • Two (2) per Lock |
| KEYWAYS: | • SCC Default (Schlage C Compatible). For additional keyways, see Cylinders and Keying section. |
| INTERCHANGEABLE CORE: | • 6-pin or 7-pin • Compatible with Best SFIC. • Not available in high security. |
| CONVENTIONAL KEY IN KNOB/LEVER CYLINDER: | • 6-pin Cylinder keyed to 5-pins |
| KEYING: | • Options: MK, CMK, or GMK, Zero Bitted (KO), Keyed Different (KD) or Keyed Alike (KA) • Can be keyed into existing master key systems. See Keyways Section. |
| FINISHES: | • 605 (US3), 613E, 622 (US19), 626 (US26D) * OTHER FINISHES AVAILABLE. CONTACT CUSTOMER SERVICE FOR QUOTE AND LEAD-TIME. |
| CERTIFICATIONS, LISTINGS, COMPLIANCES: | • ANSI, Grade 2 • UL listed for 3 hrs, for single doors up to 4'0" x 8'0" • Complies with ADA (Americans with Disabilities Act) and ICC/ANSI 117.1 for Accessible and Usable Buildings • TAA compliant. Country of origin: KR |
| WARRANTY: | • Two (2) year Limited Warranty |

How to Order

| QUANTITY | TYPE | FUNCTION | LEVER | ROSE | FINISH | BACKSET | HANDING | STRIKE | CYLINDER | KEYWAY | OPTION |
|----------|------|----------|--------------------|---------------------------------------|--------|--------------|-----------------|--------------------------|---|---------|---------------|
| 6 | CL | 116 | PHL | — | 626 | 234 | — | FL | D | SCC | — |
| | | | MIA — Miami | BLANK — Round Rose (default) | 605 | 238 — 2-3/8" | LH — Left Hand | ASA — ASA | D Default | PAGE 89 | DB — Dust Box |
| | | | PHL — Philadelphia | (default) All Levers | 613E | 234 — 2-3/4" | RH — Right Hand | FL — Full Lip | L Less Cylinder | | |
| | | | BSN — Boston | SR — Square Rose (Orlando Lever Only) | 622 | | | T — "T" Strike (default) | SF6 Lock is SFIC prepped w/ 6 pin core | | |
| | | | MEM — Memphis | | 626 | | | | SF7 Lock is SFIC prepped w/ 7 pin core | | |
| | | | ORL — Orlando | | | | | | SFL Lock is SFIC prepped but less core | | |
| | | | | | | | | | SFC Lock is SFIC prepped w/ construction core | | |
| | | | | | | | | | SFP Lock is SFIC prepped w/ plastic construction core | | |
| | | | | | | PAGE 90 | | PAGE 88 | PAGE 89 | | PAGE 90 |

| ANSI NO. | FUNCTION | DESCRIPTION | 626 | 605/613E 622 |
|---|----------|---------------------------------------|----------|--------------|
| NON-KEYED | | | | |
| | 176 | Passage Lever with Deadbolt Indicator | \$362.00 | \$384.00 |
| SINGLE CYLINDER | | | | |
| F95 | 126 | Entrance, Passage Lever | \$444.00 | \$466.00 |
| DOUBLE CYLINDER | | | | |
| F98 | 115 | Storeroom, Privacy Lever | \$463.00 | \$485.00 |
| F97 | 116 | Entrance, Privacy Lever | | |
| List prices shown include conventional key in knob/lever cylinder. | | | | |

| CYLINDER OPTIONS | ICON | LOCK ADJUSTMENT |
|------------------|---|-----------------|
| D |  | N/C |
| SFL |  | |

IC Core not included see page 89 for core options

NOTES:

- Prices do not include IC Cores
- Locks will be furnished with 2-3/4" Backset, T-Strike & SCC Keyway unless otherwise stated
- 2-3/4" Latchbolt will be furnished with 2-1/4" x 1-1/8" faceplate unless otherwise stated
- 2-3/8" Latchbolt will be furnished with 2-1/4" x 1" faceplate unless otherwise stated

Trim

| CODE | DESCRIPTION | LOCK ADJUSTMENT |
|------|-------------|-----------------|
| — | Round Rose | N/C |
| SR | Square Rose | \$20.00 |

CL SERIES

LIST PRICE
Effective July 3, 2023

Lever Designs

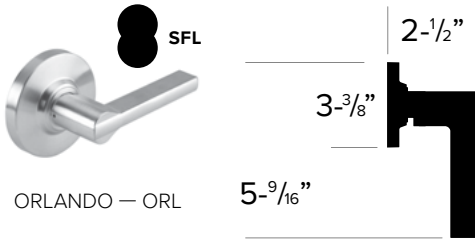
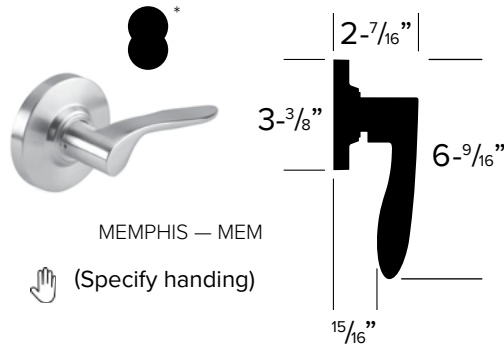
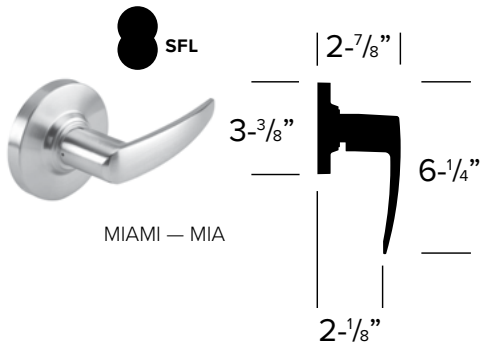
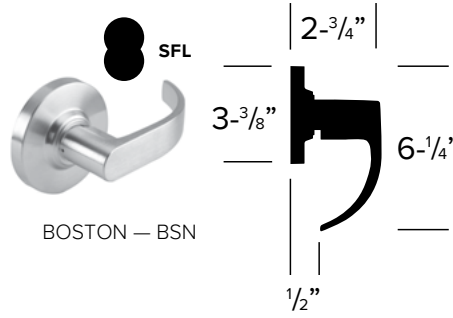
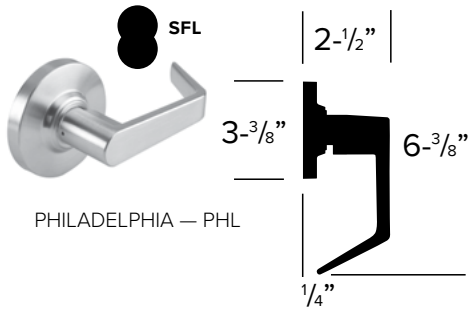

ALL LEVERS

* Small Format with MEM lever is only available in non-keyed, and single cylinder configurations.

Trim Designs

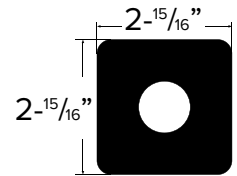

Dimensions

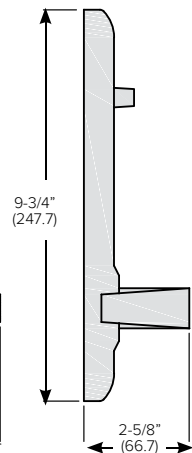
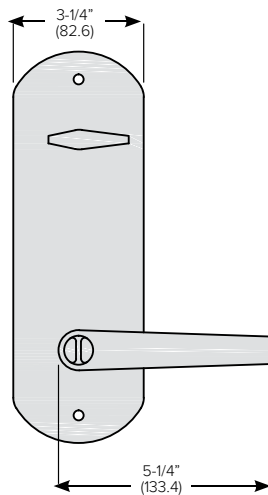

2-3/4" (69.9) Standard,
2-3/8" (60.3) Optional

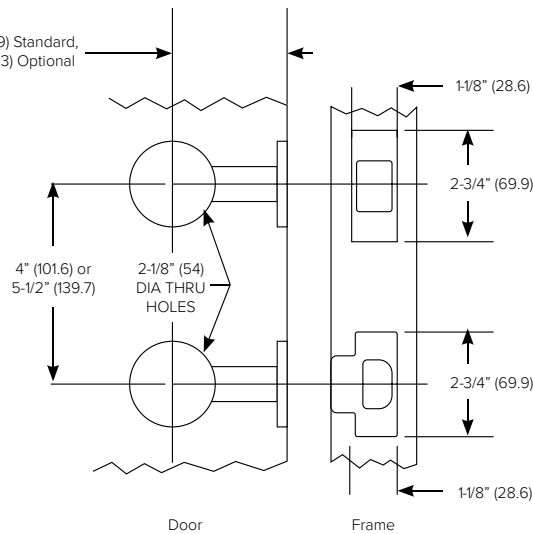

Note: Dimensions in parenthesis in millimeters

Note: Fits ANSI/BHMA 156.115 door preparation for Interconnected Locks

Latchbolts

| CODE | BACKSET | FACEPLATE | CORNERS | LOCK ADJUSTMENT |
|------|-----------------|-----------------|------------------|-----------------|
| 238 | 2-3/8" | 2-1/4" X 1 | SQUARE (DEFAULT) | N/C |
| 238F | | 2-1/4" X 1-1/8" | SQUARE | |
| 238R | | 2-1/4" X 1 | 1/4" RADIUS | |
| 238 | | 2-1/4" X 1 | SQUARE (DEFAULT) | |
| 238F | 2-1/4" X 1-1/8" | SQUARE | | |
| 238R | 2-1/4" X 1 | 1/4" RADIUS | | |
| 234F | 2-3/4" | 2-1/4" X 1 | SQUARE | |
| 234 | | 2-1/4" X 1-1/8" | SQUARE (DEFAULT) | |
| 234F | | 2-1/4" X 1 | SQUARE | |
| 234 | | 2-1/4" X 1-1/8" | SQUARE (DEFAULT) | |
| 234R | | 2-1/4" X 1-1/8" | 1/4" RADIUS | |



Dead Latch



Springlatch

Strikes

| | CODE | DESCRIPTION | LOCK ADJUSTMENT |
|---|------|--|-----------------|
|  | ASA | ASA Strike (any finish) 1-1/4" x 4-7/8" | N/C |
|  | T | T-Strike (any finish) 1-1/8" x 2-3/4" | |
|  | FL | Full Lip Strike (any finish) 1-5/8" x 2-1/4" | |



Deadbolt

Note 1 - Dust Boxes for Deadbolt and Latchbolt included with the lock.

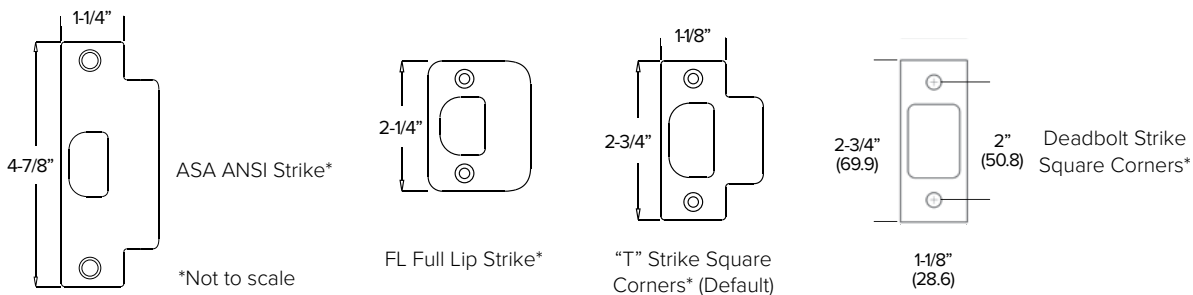

Keyways and Cylinders

| PDQ KEYWAY | COMPATIBLE WITH | SOLD WITH LOCK | |
|------------|---|----------------|---------------|
| AR1 | Arrow / AR1 | N/C | |
| CO59A1 | Corbin / 59A1 | | |
| CO6 | Corbin / 60 | | |
| CL4 | Corbin / L4 | | |
| RUD | Russwin / D1 | | |
| SCE | Schlage / E | | |
| SCC | Schlage / C | | |
| SCC-K | Schlage / C-K | | |
| SAL | Sargent / LA | | |
| RA-RC | Sargent / RA-RC | | |
| YA8 | Yale / EIR | | |
| GA | Yale / GA | | |
| FAL | Falcon / E-R | | |
| KW | Kwikset | | |
| TA | PDQ / TA (Restricted. Limited to Grandmaster systems w/4 masters) | | |
| Dummy | — | | |
| T-Turn | — | | |
| L | Less Cylinder | | Deduct \$4.00 |

NOTES:

- Specify finish for cylinders ordered separately
- Kwikset cylinder available in 5 pin only
- Specify KD, KA4, or 1 bitted
- 6 pin cylinder keyed for 5 pin



Key in Knob/Lever Cylinder

Cores and Keyways

| DESCRIPTION | PDQ NO. | ADD |
|--|------------------|---------|
| UNCOMBINED | | |
| 6 Pin Cores | I5206 + KEYWAY | \$40.00 |
| 7 Pin Cores | I5207 + KEYWAY | |
| COMBINED | | |
| 6 Pin Cores | I5206-1 + KEYWAY | \$60.00 |
| 7 Pin Cores | I5207-1 + KEYWAY | |
| BEST Compatible | | |
| A (DEFAULT), B, C, D, E, F, G, H, J, K, L, M, Q, | | |
| WA, WB, WC, WG, WH, TB, TD, TE, & R | | |
| PDQ Exclusive | | |
| PDQ1, PDQ2 | | |
| PDQ Exclusive and Restricted | | |
| PDQ3 | | |
| SFIC CONSTRUCTION | | |
| Construction Core 6-pin only | | \$60.00 |
| Dummy Construction Core Plastic | | \$8.00 |

NOTES:

- Specify finish for IC Cores ordered separately
- Control keys must be ordered separately
- **PDQ1, PDQ2, PDQ3 (Restricted)**, Best A2 & A4 Systems Available

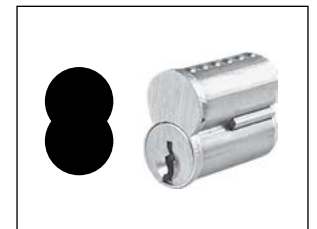

SFL/SFIC Core

Options

| CODE | DESCRIPTION | LOCK ADJUSTMENT |
|------|-------------|-----------------|
| DB | Dust Box | \$8.00 |





Backset

| BACKSET | TYPE | FACEPLATE | CORNERS | PDQ NUMBER | PART LIST PRICE |
|------------|-------------|-----------------|------------------|------------------|-----------------|
| 2-3/8" | SPRINGLATCH | 2-1/4" X 1 | SQUARE (DEFAULT) | V21900-722 | \$68.00 |
| | | 2-1/4" X 1-1/8" | SQUARE | V21900-724 | |
| | | 2-1/4" X 1 | 1/4" RADIUS | V21900-722R | |
| | DEADLATCH | 2-1/4" X 1 | SQUARE (DEFAULT) | V21900-721 | |
| | | 2-1/4" X 1-1/8" | SQUARE | V21900-723 | |
| | | 2-1/4" X 1 | 1/4" RADIUS | V21900-721R | |
| | | ADJUSTABLE | 2-1/4" X 1 | SQUARE (DEFAULT) | |
| 2-1/4" X 1 | 1/4" RADIUS | | I04507R | | |
| 2-3/4" | SPRINGLATCH | 2-1/4" X 1 | SQUARE | V21900-714 | |
| | | 2-1/4" X 1-1/8" | SQUARE (DEFAULT) | V21900-712 | |
| | DEADLATCH | 2-1/4" X 1 | SQUARE | V21900-713 | |
| | | 2-1/4" X 1-1/8" | SQUARE (DEFAULT) | V21900-711 | |

Deadbolts

| BACKSET | TYPE | FACEPLATE | CORNERS | PDQ NUMBER | LIST PRICE |
|-------------------|------------|-----------------|------------------|------------|------------|
| 2-3/8" AND 2-3/4" | ADJUSTABLE | 2-1/4" X 1 | SQUARE (DEFAULT) | I04507 | \$52.00 |
| | | 2-1/4" X 1 | 1/4" RADIUS | I04507R | |
| 2-3/4" (DEFAULT) | FIXED | 2-1/4" X 1-1/8" | SQUARE | I04510 | |

Strikes

| | CODE | DESCRIPTION | 605 | 613E | 622 | 630 | LIST PRICE |
|---|------|--|-----------|-----------|-----------|-----------|------------|
|  | ASA | ASA Strike (any finish) 1-1/4" x 4-7/8" | V91900-5 | V91900-6 | V91900-H | V91900-7 | \$38.00 |
|  | T | T-Strike (any finish) 1-1/8" x 2-3/4" | V91901-5 | V91901-6 | V91901-H | V91901-7 | \$17.00 |
|  | FL | Full Lip Strike (any finish) 1-5/8" x 2-1/4" | V919010-5 | V919010-6 | V919010-H | V919010-7 | \$14.00 |
|  | W | Deadbolt Strike | I4072-5 | I4072-6 | I4072-H | I4072-7 | |

PDQ Functions

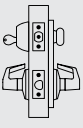
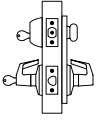
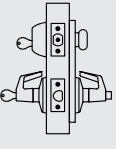
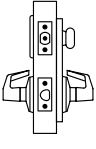
| FUNCTION | FUNCTION NUMBER | OUTSIDE INSIDE | DESCRIPTION | ANSI NUMBER |
|--|-----------------|---|--|-------------|
| Entry Single Cylinder Passage Lever | 126 |  | <ul style="list-style-type: none"> • Outside and Inside lever always free • Deadbolt projected or retracted by key outside or turnpiece inside • When deadbolt is projected, turning inside knob/lever retracts deadbolt and latchbolt simultaneously | F95 |
| Storeroom Double Cylinder (See note) Passage Lever | 115 |  | <ul style="list-style-type: none"> • Deadlocking latch bolt is operated by key outside or inside lever • Key outside projects or retracts dead bolt. • Operating inside lever or keys outside retracts dead bolt and deadlocking latch. | F98 |
| Entry Double Cylinder (See note) Privacy Lever | 116 |  | <ul style="list-style-type: none"> • Outside lever locked by turn button in inside knob/lever • Inside lever always free • Unlocking of outside lever requires use of key or manual return of inside turn button • Deadbolt is activated by key in outside deadlock or turnpiece inside • Turning inside lever retracts deadbolt and latchbolt simultaneously | F97 |
| Privacy with Dead Bolt Indicator No Cylinder Passage Lever | 176 |  | <ul style="list-style-type: none"> • Outside and Inside lever always free • Indicator outside • Thumbturn inside extends/retracts deadbolt • Emergency key outside retracts deadbolt • When deadbolt is projected, turning inside lever retracts deadbolt and latchbolt simultaneously | — |

Cross Reference

| ANSI NUMBER / FUNCTION | PDQ | CAL-ROYAL | DORMA | FALCON | HAGER | SCHLAGE | STANLEY | YALE |
|----------------------------------|--------|---------------|-------|--------|-------|------------------|---------------|--------|
| 95 / ENTRY, SINGLE CYLINDER | CL 126 | HIL00, JHIL00 | J310 | — | 3710 | CS/RS 210 SERIES | QC1230 SERIES | 4851LN |
| 97 / ENTRY, DOUBLE CYLINDER | CL 116 | HIL30, JHIL30 | J353 | H101DG | 3753 | CS/RS 250 SERIES | QC1250 SERIES | 4871LN |
| 98 / STOREROOM, DOUBLE CYLINDER | CL 115 | — | — | — | — | CS/RS 280 SERIES | QC1285 SERIES | — |
| PRIVACY W/INDICATOR, NO CYLINDER | CL 176 | — | — | — | — | — | QC1285 SERIES | — |

Information on this sheet is compiled from public documents and third parties. As a result, PDQ makes no guarantees as to their accuracy, content, quality or availability. Comparisons were made using the technical features only and are not commercial comparisons. Final suitability should be determined by a professional hardware consultant.

Typical Applications

- Apartments
- Back-of-House Hotel/Motel
- Heavy-Duty Residential
- Houses of Worship
- Medium Traffic Commercial Applications
- Offices
- Retail Backroom
- Retrofit/Repair/Replacement
- Warehouses

Features

- UL listed for 3-hour fire door
- ANSI/BHMA A156.2 Grade 2
- 9 standard functions
- Various strike and latch options to accommodate any opening
- Available in keyways of most major manufacturers
- Tactile abrasive coating option
- Antimicrobial coating option
- One (1) year limited warranty



Specifications





| | |
|---|--|
| FOR DOORS: | • 1-3/8" to 1-3/4" thick |
| BACKSET: | • 2-3/4" standard • 2-3/8", 5" optional |
| FRONT: | • 2-1/4" x 1-1/8" or 2-1/4" x 1" • Stainless Steel or Wrought Brass |
| STRIKE: | • 4-7/8" x 1-1/4" (ASA). "T" or "FL" Strike optional. Stainless steel or wrought bronze. |
| ROSE: | • 3" DIA Wrought |
| LATCHBOLT: | • 1/2" throw. Solid brass. Adjustable for beveled doors. |
| HAND: | • Non-handed |
| KEYS: | • Two change keys per lock. |
| KEYWAYS: | • Available in keyways of most major manufacturers. |
| CYLINDER: | • Brass 6-pin cylinder keyed to 5 pins. • Standard High Security and UL437 Cylinders Available |
| TRIM: | • Stainless Steel or Wrought Brass Knobs and Roses |
| KEYING: | • Can be MK, CMK, GMK, or CK. Available Zero Bitted (KO), Keyed Different (KD), Keyed Alike (KA). Can be keyed into existing masterkey systems of other manufacturers. |
| FINISHES: | • 630 (US32D) • Optional Antimicrobial Coating available |
| WARRANTY: | • One (1) Year Limited Warranty |
| CERTIFICATIONS, LISTINGS, COMPLIANCES: | • Certified to ANSI/BHMA A156.2, Grade 2 • UL/CUL 10C listed for 3 hrs, for single doors up to 4'0" x 8'0" • TAA compliant. Country of origin: KR |

How to Order

| QUANTITY | SERIES | FUNCTION | KNOB | FINISH | BACKSET | STRIKE | CYLINDER | KEYWAY | KEYING |
|----------|--------|----------|------|-------------|--|---|--|---------|--------|
| 20 | SV | 116 | CQ | 630 | 234 | ASA | D | SCC | KD |
| | | | | 605 613E | 234 — 2-3/4" 238 — 2-3/8" 334 — 3-3/4" 5 — 5" | ASA — ANSI/ ASA (default) FL — Full Lip T — "T" Strike See page 94 | D Default L Less Cylinder SF6 Lock is SFIC prepped w/ 6 pin core SF7 Lock is SFIC prepped w/ 7 pin core SFL Lock is SFIC prepped but less core SFC Lock is SFIC prepped w/ construction core SFP Lock is SFIC prepped w/ plastic construction core | PAGE 95 | |
| | | | | | | PAGE 94 | PAGE 95 | | |

NOTE: Case quantity is 20 / Case weight is 43 lbs. Keyed Functions / Case weight is 40 lbs. Non-Keyed Functions / For split finishes, designate O/S trim first, then I/S

| ANSI NO. | FUNCTION | DESCRIPTION | 630 | 605/613E |
|--|----------|---------------|----------|----------|
| NON-CYLINDER | | | | |
| | 125 | Communicating | \$100.00 | \$109.00 |
| F75 | 126 | Passage | | |
| F76 | 176 | Privacy | \$104.00 | \$113.00 |
| SINGLE CYLINDER | | | | |
| F86 | 115 | Store Room | \$122.00 | \$131.00 |
| F109 | 116 | Entrance | | |
| F84 | 148 | Classroom | | |
| DOUBLE CYLINDER | | | | |
| F91 | 137 | Store Door | \$180.00 | \$189.00 |
| DUMMY | | | | |
| | 205 | Double Dummy | \$90.00 | \$99.00 |
| | 211 | Single Dummy | \$54.00 | \$63.00 |
| List prices shown include conventional key in knob/lever cylinder. For I-C, list prices do not include core. | | | | |

| CYLINDER OPTIONS | ICON | LOCK ADJUSTMENT |
|------------------|---|-----------------|
| D |  | N/C |
| SFL |  | |

NOTES:

- Locks will be furnished with 2-3/4" Latchbolt, ASA Strike & SCC Key way unless otherwise stated
- 2-3/4" Latchbolt will be furnished with 2-1/4" x 1-1/8" faceplate unless otherwise stated
- 2-3/8" Latchbolt will be furnished with 2-1/4" x 1" faceplate unless otherwise stated

Trim



BALL KNOB - CQ

SV SERIES

LIST PRICE

Effective July 3, 2023

| CODE | DESCRIPTION | LOCK ADJUSTMENT |
|-----------------------|---------------------------|-----------------|
| 2-3/4" BACKSET | | |
| 234 | 2-1/4" x 1-1/8" | N/C |
| 234F | 2-1/4" x 1" | |
| 234FR | 2-1/4" x 1" x 1/4" Radius | \$5.00 |
| 2-3/8" BACKSET | | |
| 238F | 2-1/4" x 1-1/8" | N/C |
| 238 | 2-1/4" x 1" | |
| 238R | 2-1/4" x 1" x 1/4" Radius | \$5.00 |
| 3-3/4" BACKSET | | |
| 334F | 2-1/4" x 1-1/8" | \$18.00 |
| 334 | 2-1/4" x 1" | |
| 334R | 2-1/4" x 1" x 1/4" Radius | |
| 5" BACKSET | | |
| 5 | 2-1/4" x 1-1/8" | \$24.00 |
| 5F | 2-1/4" x 1" | |
| 5FR | 2-1/4" x 1" x 1/4" Radius | |



Latchbolt



Deadlatch

Strikes

| | CODE | DESCRIPTION | LOCK ADJUSTMENT |
|---|------|--|-----------------|
|  | ASA | ASA Strike (any finish) 1-1/4" x 4-7/8" | N/C |
|  | T | T-Strike (any finish) 1-1/8" x 2-3/4" | |
|  | FL | Full Lip Strike (any finish) 1-5/8" x 2-1/4" | |

NOTES:

- Specify finish for Strikes & Latchbolts if ordered separately

Keyways and Cylinders

| PDQ KEYWAY | COMPATIBLE WITH | SOLD WITH LOCK | |
|---|---|----------------|---------------|
| AR1 | Arrow / AR1 | N/C | |
| CO59A1 | Corbin / 59A1 | | |
| CO6 | Corbin / 60 | | |
| CL4 | Corbin / L4 | | |
| RUD | Russwin / D1 | | |
| SCE | Schlage / E | | |
| SCC | Schlage / C | | |
| SCC-K | Schlage / C-K | | |
| SAL | Sargent / LA | | |
| RA-RC | Sargent / RA-RC | | |
| YA8 | Yale / E1R | | |
| GA | Yale / GA | | |
| FAL | Falcon / E-R | | |
| KW | Kwikset | | |
| TA | PDQ / TA (Restricted. Limited to Grandmaster systems w/4 masters) | | |
| Dummy | — | | |
| T-Turn | — | | |
| L | Less Cylinder | | Deduct \$4.00 |
| HIGH SECURITY CYLINDERS AND CORES | | | |
| SEE HIGH SECURITY CYLINDERS AND CORES SECTION, PAGE | | | |

NOTES:

- Specify finish for cylinders ordered separately
- Kwikset cylinder available in 5 pin only
- Specify KD, KA4, or 1 bitted
- 6 pin cylinder keyed for 5 pin

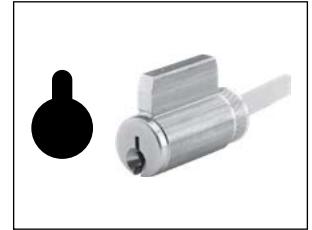

Key in Knob/Lever Cylinder



UL 437 and High Security Cylinders

Cores and Keyways

| DESCRIPTION | PDQ NO. | ADD |
|---|------------------|---------|
| SMALL FORMAT UNCOMBINATED | | |
| 6 Pin Cores | I5206 + KEYWAY | \$40.00 |
| 7 Pin Cores | I5207 + KEYWAY | |
| COMBINATED | | |
| 6 Pin Cores | I5206-1 + KEYWAY | \$60.00 |
| 7 Pin Cores | I5207-1 + KEYWAY | |
| BEST[®] Compatible | | |
| A (DEFAULT), B, C, D, E, F, G, H, J, K, L, M, Q, | | |
| WA, WB, WC, WG, WH, TB, TD, TE, & R | | |
| PDQ Exclusive | | |
| PDQ1, PDQ2 | | |
| PDQ Exclusive and Restricted | | |
| PDQ3 | | |
| SFIC CONSTRUCTION | | |
| Construction Core 6-pin only | | \$60.00 |
| Dummy Construction Core Plastic | | \$8.00 |
| HIGH SECURITY IC CORES | | |
| SEE HIGH SECURITY CYLINDERS AND CORES SECTION, PAGE 118. — LFIC REQUIRES LARGE FORMAT LEVER | | |

NOTES:

- Specify finish for IC Cores ordered separately
- Control keys must be ordered separately
- **PDQ1, PDQ2, PDQ3 (Restricted)**, Best A2 & A4 Systems Available

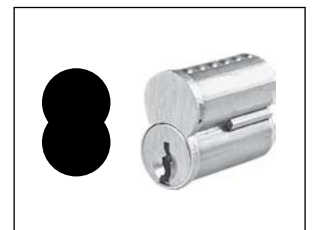

SFL/SFIC Core

SV SERIES PARTS

LIST PRICE

Effective July 3, 2023

Backset

| CODE | TYPE | FACEPLATE | CORNERS | PDQ NUMBER | LIST PRICE | |
|--|-------------|-----------------|------------------|-------------|------------|--|
| 2-3/4" BACKSET | | | | | | |
| 234F | SPRINGLATCH | 2-1/4" X 1 | SQUARE | V21900-714 | \$68.00 | |
| 234 | | 2-1/4" X 1-1/8" | SQUARE (DEFAULT) | V21900-712 | | |
| 234F | DEADLATCH | 2-1/4" X 1 | SQUARE | V21900-713 | | |
| 234 | | 2-1/4" X 1-1/8" | SQUARE (DEFAULT) | V21900-711 | | |
| 2-3/8" BACKSET | | | | | | |
| 238 | SPRINGLATCH | 2-1/4" X 1 | SQUARE (DEFAULT) | V21900-722 | | |
| 238F | | 2-1/4" X 1-1/8" | SQUARE | V21900-724 | | |
| 238R | | 2-1/4" X 1 | 1/4" RADIUS | V21900-722R | | |
| 238 | DEADLATCH | 2-1/4" X 1 | SQUARE (DEFAULT) | V21900-721 | | |
| 238F | | 2-1/4" X 1-1/8" | SQUARE | V21900-723 | | |
| 238R | | 2-1/4" X 1 | 1/4" RADIUS | V21900-721R | | |
| 3-3/4" BACKSET EXTENSION | | | | | | |
| Extension for 2-3/8" latch (sold separately) to make 3-3/4" Backset. | | | | V21903 | \$55.00 | |
| 5" BACKSET EXTENSION | | | | | | |
| Extension for 2-3/4" latch (sold separately) to make 5" Backset. | | | | V21902 | | |

Strikes

| | CODE | DESCRIPTION | 605 | 613E | 630 | LIST PRICE |
|---|------|--|-----------|-----------|-----------|------------|
|  | ASA | ASA Strike (any finish) 1-1/4" x 4-7/8" | V91900-5 | V91900-6 | V91900-1 | \$38.00 |
|  | T | T-Strike (any finish) 1-1/8" x 2-3/4" | V91901-5 | V91901-6 | V91901-1 | \$17.00 |
|  | FL | Full Lip Strike (any finish) 1-5/8" x 2-1/4" | V919010-5 | V919010-6 | V919010-1 | \$14.00 |

PDQ Functions

| FUNCTION | FUNCTION NUMBER | INSIDE OUTSIDE | DESCRIPTION | ANSI NUMBER |
|--------------------------------|-----------------|------------------|---|-------------|
| NON KEYED | | | | |
| Closet/ Communicating | SV125 | | <ul style="list-style-type: none"> Blank plate outside Inner knob always free Deadlocking (guarded) latchbolt | — |
| Passage | SV126 | | <ul style="list-style-type: none"> Latchbolt operated by both knobs | F75 |
| Privacy Bedroom Bathroom | SV176 | | <ul style="list-style-type: none"> Latchbolt operated by both knobs Push button in inside knob locks outside knob Inside knob or closing door releases button Emergency opening from outside | F76 |
| KEYED | | | | |
| Storeroom | SV115 | | <ul style="list-style-type: none"> Latchbolt operated from outside by key, inside by knob Outside knob is rigid at all times Inside knob always free for immediate exit | F86 |
| Entrance | SV116 | | <ul style="list-style-type: none"> Latchbolt operated by both knobs Outside knob locked or unlocked by turn/push button Inside knob always free Pushing and turning button locks outside knob requiring use of key until button is manually unlocked Pushing button only locks outside knob until unlocked with key or inside knob is turned | F109 |
| General Entrance | SV137 | | <ul style="list-style-type: none"> Latchbolt operated by both knobs Key on either side locks or unlocks | — |
| Classroom Storage | SV148 | | <ul style="list-style-type: none"> Latchbolt operated from outside by knob except when locked from outside by key Latchbolt operated from inside by knob at all times | F84 |
| DUMMY | | | | |
| Single Dummy | SV211 | | <ul style="list-style-type: none"> Single pull knob Single side surface No mechanical operation | — |
| Double Dummy | SV205 | | <ul style="list-style-type: none"> Double pull knob Both sides No mechanical operation 2-1/8" bored hole | — |

INDICATES RIGID KNOB

Secure. Durable. Versatile.

Deadbolts are often paired with a cylindrical lock in commercial office spaces, residential applications and other spaces where there is a greater need for security—and, more specifically, a deadbolt that is more resistant to brute force attack. PDQ deadbolts provide security for a wide range of applications while allowing end users to meet their specific security needs.

KM

Heavy Duty Rim Cylinder
Mechanical



Applications

Heavy duty performance. Ideal for commercial, institutional, government, military, hospitality, hospital, multi-family, offices, and retail applications. Typical installations include storerooms, auxiliary entrance locks, communication doors in hotels, and aluminum storefronts.

KT

Extra Heavy Duty
Mortise Cylinder



Applications

Heavy duty performance. Ideal for commercial, institutional, government, military, hospitality, hospital, multi-family, offices, and retail applications.

KV

Commercial Duty
Rim Cylinder



Applications

Standard duty performance, ideal for light commercial and residential applications.

MJ

Extra Heavy Duty
Mortise Cylinder



Applications

Small body deadbolt provides an extra measure of protection at a competitive price. Uses include common areas, auxiliary doors, closets, storerooms, and equipment rooms in commercial, institutional and military applications.

Typical Applications

- Commercial
- Government
- Hospitality
- Institutional
- Military
- Multi-family
- Offices
- Retail



Deadbolt is Grade Comparable with GP and SD Series Grade 2 Cylindrical Locks



ADA COMPLIANT

Specifications

| | |
|---|--|
| FOR DOORS: | • 1-3/8" to 1-3/4" thick for Conventional Cylinder, 1-1/2" to 2" for SFIC |
| DOOR PREP: | • 2-1/8" DIA |
| BACKSET: | • 2-3/4" - 2-3/8" adjustable (Default) • 2-3/4" (Option) |
| FRONT: | • 2-1/4" x 1-1/8" (Default) • 2-1/4" x 1" faceplate available • Stainless Steel or Wrought Brass |
| STRIKE: | • 2-3/4" x 1-1/8" • Stainless Steel or Wrought Brass • Dust Box Included |
| DEADBOLT: | • 1" Throw • Brass Bolt containing one 1/4" case-hardened Steel Roll Pin |
| THUMBTURN: | • ADA Compliant |
| HAND: | • Non-handed |
| TRIM: | • Stainless Steel or Wrought Brass Scalp • Reinforced Diecast Rose |
| KEYS: | • Two (2) per Lock |
| KEYWAYS: | • SCC standard (Schlage C Compatible) • Also available in keyways of other manufacturers |
| INTERCHANGEABLE CORE: | • 6 or 7-pin • Compatible with Best, Falcon and Arrow |
| CYLINDER: | • 6-pin Brass Insert Cylinder keyed to 5-pins • Standard High Security and UL437 Cylinders Available |
| KEYING: | • Options: MK, CMK or GMK • Zero Bitted (KO), Keyed Different (KD) or Keyed Alike (KA) • Can be keyed into existing master key systems |
| FINISHES: | • 605 (US3), 606 (US4), 613E, 622 (US19), 626 (US26D), 630 (US32D) |
| CERTIFICATIONS, LISTINGS, COMPLIANCES: | • UL 10C listed, 3-hour fire rated as auxiliary locks for A label single doors • UL 10B listed for neutral pressure doors • Complies with ADA (Americans with Disabilities Act) and ICC/ANSI 117.1 for Accessible and Usable Buildings • TAA compliant. Country of origin: KR |
| WARRANTY: | • One (1) year Limited Warranty |

PDQ Functions

KM SERIES
DEADBOLT LOCKS

| FUNCTION | FUNCTION NUMBER | OUTSIDE INSIDE | DESCRIPTION | ANSI NUMBER |
|-----------------|-----------------|------------------|---|-------------|
| Single Cylinder | 116 | | <ul style="list-style-type: none"> Lock or unlock by key from outside, by thumb turn from inside | E1151 |
| Double Cylinder | 137 | | <ul style="list-style-type: none"> Lock or unlock by key from both sides | E1141 |
| Classroom | 148 | | <ul style="list-style-type: none"> Lock or unlock by key from outside Turnpiece inside retracts deadbolt, but will not project it | E1171 |

How to Order

| QUANTITY | SERIES | FUNCTION | FINISH | BACKSET | CYLINDER | KEYWAY | KEYING |
|--|--------|----------|---|---|---|-------------------------|-----------------|
| 20 | KM | 116 | 630 605 606 613E 622 626 630 | ADJ 234 — 2-3/4" 238 — 2-3/8" ADJ — Adjustable 2-3/4"—2-3/8"(Default) | D Default L Less Cylinder SF6 Lock is SFIC prepped w/ 6 pin core SF7 Lock is SFIC prepped w/ 7 pin core SFL Lock is SFIC prepped but less core SFC Lock is SFIC prepped w/ construction core SFP Lock is SFIC prepped w/ plastic construction core | SCC KD | PAGE 102 |
| NOTE: Case quantity is 20 / Case weight varies | | | | PAGE 101 | PAGE 102 | | |

Deadbolts

| ANSI NO. | FUNCTION | DESCRIPTION | 626/630 | 605/606/613E 622 |
|------------------------|----------|-------------|----------|---------------------|
| SINGLE CYLINDER | | | | |
| E1151 | 116 | Entrance | \$105.00 | \$117.00 |
| E1171 | 148 | Classroom | | |
| DOUBLE CYLINDER | | | | |
| E1141 | 137 | Store Door | \$130.00 | \$142.00 |

List prices shown include conventional RIM cylinder. For I-C, list prices do not include core.

| CYLINDER OPTIONS | ICON | LOCK ADJUSTMENT |
|------------------|------|-----------------|
| D | | N/C |
| SFL | | |

NOTES:

- Prices do not include IC Core



Backset

| CODE | BACKSET DESCRIPTION | LOCK ADJUSTMENT |
|-----------------------------------|-------------------------------|-----------------|
| <i>2-3/8" Backset</i> | | |
| 238 | 2-1/4" x 1" | N/C |
| 238R | 2-1/4" x 1" x 1/4" Radius | \$5.00 |
| <i>2-3/4" Backset</i> | | |
| 234 | 2-1/4" x 1-1/8" (Standard) | N/C |
| 234R | 2-1/4" x 1-1/8" x 1/4" Radius | \$5.00 |
| <i>2-3/4" - 2-3/8" ADJUSTABLE</i> | | |
| ADJ | 2-1/4" x 1-1/8" (Standard) | N/C |
| ADJR | 2-1/4" x 1-1/8" x 1/4" Radius | \$5.00 |

Keyways and Cylinders

KM SERIES
DEADBOLT LOCKS

| PDQ KEYWAY | COMPATIBLE WITH | SOLD WITH LOCK | |
|------------|---|----------------|---------------------|
| ARA | Arrow / AR1 | N/C | |
| CO59A1 | Corbin / 59A1 | | |
| CO6 | Corbin / 60 | | |
| CL4 | Corbin / L4 | | |
| RUD | Russwin / D1 | | |
| SCE | Schlage / E | | |
| SCC | Schlage / C | | |
| SCC-K | Schlage / C-K | | |
| SAL | Sargent / LA | | |
| RA-RC | Sargent / RA-RC | | |
| YAB | Yale / E1R | | |
| GA | Yale / GA | | |
| FAL | Falcon / E-R | | |
| TA | PDQ / TA (Restricted. Limited to Grandmaster systems w/4 masters) | | \$3.00 |
| L | Less Cylinder | | Deduct \$8/Cylinder |

NOTES:

- Specify finish for Rim Cylinders ordered separately



Rim Cylinder



UL 437 and High Security Cylinders

Cores and Keyways

| DESCRIPTION | PDQ NO. | ADD |
|---|------------------|---------|
| UNCOMBINATED | | |
| 6 Pin Cores | I5206 + KEYWAY | \$40.00 |
| 7 Pin Cores | I5207 + KEYWAY | |
| COMBINATED | | |
| 6 Pin Cores | I5206-1 + KEYWAY | \$60.00 |
| 7 Pin Cores | I5207-1 + KEYWAY | |
| BEST[®] Compatible | | |
| A (DEFAULT), B, C, D, E, F, G, H, J, K, L, M, Q, | | |
| WA, WB, WC, WG, WH, TB, TD, TE, & R | | |
| PDQ Exclusive | | |
| PDQ1, PDQ2 | | |
| PDQ Exclusive and Restricted | | |
| PDQ3 | | |
| SFIC CONSTRUCTION | | |
| Construction Core 6-pin only | | \$60.00 |
| Dummy Construction Core Plastic Construction cores are invoiced at shipment and credited upon return. | | \$8.00 |
| HIGH SECURITY IC CORES | | |
| SEE HIGH SECURITY CYLINDERS AND CORES SECTION, PAGE 118. — NOT AVAILABLE WITH LFIC | | |

NOTES:

- Combinated cores include master keying in the list price
- Specify finish for IC Cores ordered separately
- Control keys must be ordered separately
- **PDQ1, PDQ2, PDQ3 (Restricted)**, Best A2 & A4 Systems Available

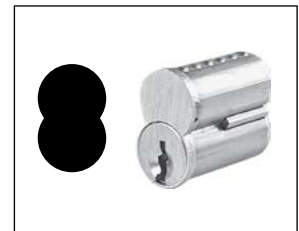

SFL/SFIC Core



Backset

| BACKSET DESCRIPTION | 605 | 613E | 622 | 630 | LIST PRICE | |
|--|-----------|-----------|----------|-----------|------------|--------|
| 2-3/8" Backset | | | | | | |
| 2-1/4" x 1-1/8" (Default) | I04509-5 | I04509-6 | I04509-H | I04509-1 | \$50.00 | |
| 2-1/4" x 1-1/8" x 1/4" Radius | I04509-5R | I04509-6R | I04509-H | I04509-1R | | |
| 2-3/4" Backset | | | | | | |
| 2-1/4" x 1-1/8" (Default) | I04510-5 | I04510-6 | I04510-H | I04510-1 | | |
| 2-1/4" x 1-1/8" x 1/4" Radius | I04510-5R | I04510-6R | I04510-H | I04510-1R | | |
| 2-3/4" - 2-3/8" ADJUSTABLE | | | | | | |
| 2-1/4" x 1-1/8" (Default) | I04507-5 | I04507-6 | I04507-H | I04507-1 | | |
| 2-1/4" x 1-1/8" x 1/4" Radius | I04507-5R | I04507-6R | I04507-H | I04507-1R | | |
| 1-1/8" Latch Front Filler Plate (Minimum of 100 pieces) | I099-100 | | | | | \$5.00 |

KM SERIES
DEADBOLT LOCKS

Strikes

| DESCRIPTION | 605 | 613E | 622 | 630 | LIST PRICE |
|---------------------------------|---------|---------|---------|---------|------------|
| Deadbolt Strike 2-3/4" x 1-1/8" | I4702-5 | I4702-6 | I4702-H | I4702-1 | \$25.00 |
| Dust Box | I4701 | | | | \$8.00 |

Typical Applications

- Commercial
- Government
- Hospitality
- Institutional
- Military
- Multi-family
- Offices
- Retail



Deadbolt is Grade Comparable with XGT and GT Series Grade 1 Cylindrical Locks

Specifications



| | |
|-------------------|--|
| FOR DOORS: | • 1-3/4" thick standard, contact factory for other thicknesses |
| DOOR PREP: | • 2-1/8" DIA |
| BACKSET: | • 2-3/4" (Default) • 2-3/8" available |
| FRONT: | • 2-1/4" x 1-1/8" or 2-1/4" x 1" • Stainless Steel or Wrought Brass |
| STRIKE: | • 2-3/4" x 1-1/8" • Stainless Steel or Wrought Brass • Dust Box Included |
| DEADBOLT: | • 1" Throw • Brass Bolt containing two concealed 1/4" case-hardened Steel Roll Pins |
| HAND: | • Non-handed |
| TRIM: | • Wrought Brass Scalp • Reinforced Diecast Rose |
| KEYS: | • Two (2) per Lock |
| KEYWAYS: | • SCC standard (Schlage C Compatible) • Also available in keyways of other manufacturers |
| CYLINDER: | • 6-pin Brass Mortise Cylinder keyed to 5-pins, SFIC |
| KEYING: | • Options: MK, CMK or GMK • Zero Bitted (KO), Keyed Different (KD) or Keyed Alike (KA) • Can be keyed into existing master key systems |
| FINISHES: | • 605 (US3), 606 (US4), 612 (US10), 613E, 625 (US26), 626 (US26D) |
| WARRANTY: | • One (1) year Limited Warranty |
| LISTINGS: | • UL 10C listed, 3-hour fire rated as auxiliary locks for A label single doors • UL 10B listed for neutral pressure doors |

PDQ Functions

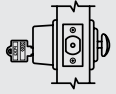
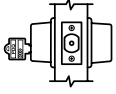
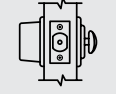
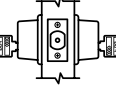
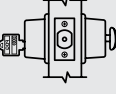
| FUNCTION | FUNCTION NUMBER | OUTSIDE INSIDE | DESCRIPTION | ANSI NUMBER |
|-----------------|-----------------|---|---|-------------|
| Entrance | 116 |  | <ul style="list-style-type: none"> Lock or unlock by key from outside, by thumb turn from inside | E1151 |
| Single Cylinder | 121 |  | <ul style="list-style-type: none"> Lock or unlock by key from outside Blank mortise cylinder on inside | E1161 |
| Single Sided | 125 |  | <ul style="list-style-type: none"> Deadbolt by inside thumb turn only Blank mortise cylinder on outside | E1112 |
| Double Cylinder | 137 |  | <ul style="list-style-type: none"> Lock or unlock by key from both sides | E1141 |
| Classroom | 148 |  | <ul style="list-style-type: none"> Lock or unlock by key from outside Turnpiece inside retracts deadbolt, but will not project it | E1171 |

How to Order

| QUANTITY | SERIES | FUNCTION | FINISH | BACKSET | CYLINDER | KEYWAY | KEYING |
|--|--------|----------|--------|---|--|----------|--------|
| 10 | KT | 116 | 626 | 234 | D | SCC | KD |
| NOTE: Case quantity is 10 / Case weight is 19 lbs. Single Cylinder / Case weight is 22 lbs. Double Cylinder / For split finishes, designate O/S trim first, then I/S | | | | 234 — 2-1/4" x 1-1/8" (Standard) 234R — 2-1/4" x 1-1/8" x 1/4" Radius 234D — Drive-in 238 — 2-1/4" x 1" 238R — 2-1/4" x 1" x 1/4" Radius 238D — Drive-in | D — Default L — Less Cylinder | PAGE 106 | |
| | | | | PAGE 106 | | | |

Deadbolts

| ANSI NO. | FUNCTION | DESCRIPTION | 626 | 605/606/612 613E/625 |
|------------------------|----------|-----------------------|----------|-------------------------|
| NON-CYLINDER | | | | |
| E1112 | 125 | Communicating | \$132.00 | \$144.00 |
| SINGLE CYLINDER | | | | |
| E1151 | 116 | Entrance | \$175.00 | \$187.00 |
| E1171 | 148 | Classroom | | |
| E1161 | 121 | Blank Single Cylinder | | |
| DOUBLE CYLINDER | | | | |
| E1141 | 137 | Store Door | \$185.00 | \$197.00 |

NOTES:

- Consult Customer Service for availability of Split Finish
- 2-3/4" Latchbolt will be furnished with 2-1/4" x 1-1/8" faceplate unless otherwise stated
- 2-3/8" Latchbolt will be furnished with 2-1/4" x 1" face plate unless otherwise stated
- ADA thumbturn available special order

List prices shown include conventional key in knob/lever cylinder. For I-C, list prices do not include core.

Backset

| CODE | BACKSET DESCRIPTION | LOCK ADJUSTMENT |
|-----------------------|-------------------------------|-----------------|
| <i>2-3/4" Backset</i> | | |
| 234 | 2-1/4" x 1-1/8" (Standard) | N/C |
| 234R | 2-1/4" x 1-1/8" x 1/4" Radius | \$5.00 |
| 234D | Drive-in | N/C |
| <i>2-3/8" Backset</i> | | |
| 238 | 2-1/4" x 1" (Standard) | N/C |
| 238R | 2-1/4" x 1" x 1/4" Radius | \$5.00 |
| 238D | Drive-in | N/C |

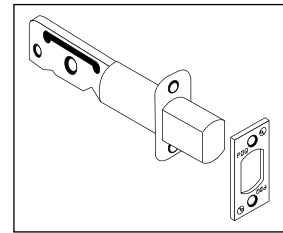

Bolt

KT SERIES
DEADBOLT LOCKS

Keyways and Mortise Cylinders

| PDQ KEYWAY | COMPATIBLE WITH | SOLD WITH LOCK | |
|------------|---|----------------|---------------------|
| ARA | Arrow / AR1 | N/C | |
| CO59A1 | Corbin / 59A1 | | |
| CO6 | Corbin / 60 | | |
| CL4 | Corbin / L4 | | |
| RUD | Ruswin / D1 | | |
| SCE | Schlage / E | | |
| SCC | Schlage / C | | |
| SCC-K | Schlage / C-K | | |
| SAL | Sargent / LA | | |
| RA-RC | Sargent / RA-RC | | |
| YA8 | Yale / E1R | | |
| GA | Yale / GA | | |
| FAL | Falcon / E-R | | |
| TA | PDQ / TA (Restricted. Limited to Grandmaster systems w/4 masters) | | \$3.00 |
| L | Less Cylinder | | Deduct \$8/Cylinder |

NOTES:

- Specify finish for Mortise Cylinders ordered separately



Mortise Cylinder

KT SERIES PARTS

LIST PRICE
Effective July 3, 2023

Backset

| BACKSET DESCRIPTION | PDQ NO. | LIST PRICE | |
|-------------------------------|---------|------------|--|
| 2-3/4" Backset | | | |
| 2-1/4" x 1-1/8" (Default) | I4301 | \$50.00 | |
| 2-1/4" x 1-1/8" x 1/4" Radius | I4301R | | |
| Drive-in | I4201-5 | | |
| 2-3/8" Backset | | | |
| 2-1/4" x 1" (Default) | I4302 | | |
| 2-1/4" x 1" x 1/4" Radius | I4302R | | |
| Drive-in | I4202-5 | | |

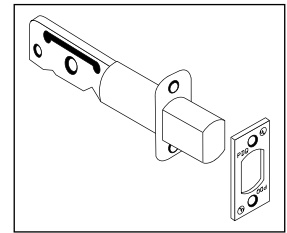

Bolt

KT SERIES
DEADBOLT LOCKS

Strikes

| DESCRIPTION | 605 | 613E | 630 | LIST PRICE |
|---------------------------------|----------|----------|----------|------------|
| Deadbolt Strike 2-3/4" x 1-1/8" | I46021-5 | I46021-6 | I46021-1 | \$25.00 |
| Dust Box | I4587 | | | \$8.00 |

Typical Applications

- Light Commercial Installations
- Low Security Applications
- Residential

Deadbolts are Grade Comparable with SD Series Grade 2 Cylindrical Locks

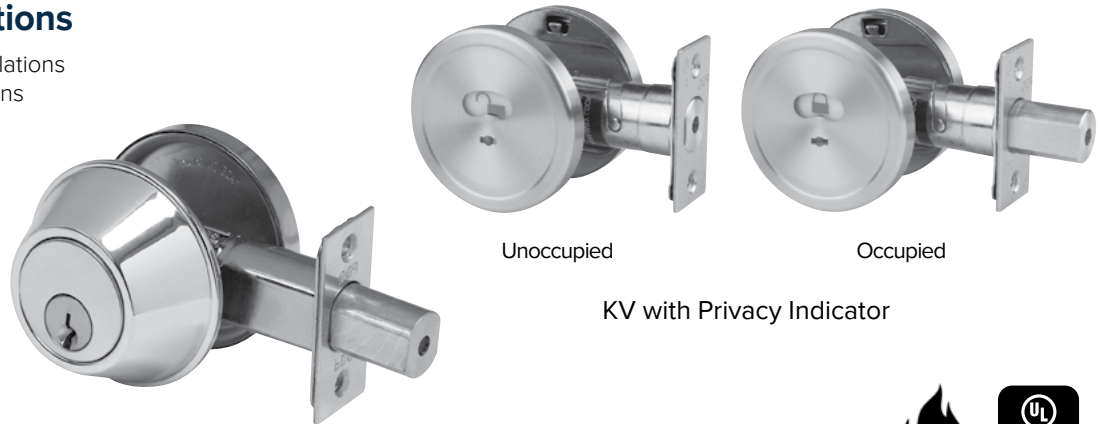

Specifications



| | |
|---|--|
| FOR DOORS: | • 1-3/8" to 1-3/4" thick for Conventional Cylinder, 1-1/2" to 2" for SFIC |
| DOOR PREP: | • 2-1/8" DIA |
| BACKSET: | • 2-3/4"/2-3/8" adjustable (Default) |
| FRONT: | • 2-1/4" x 1" with filler plate • Stainless Steel or Wrought Brass |
| STRIKE: | • 2-3/4" x 1" • Stainless Steel or Wrought Brass • Dust Box Included |
| DEADBOLT: | • 1" Throw • Brass Bolt containing one 1/4" case-hardened Steel Roll Pin |
| HAND: | • Non-handed |
| TRIM: | • Stainless Steel or Wrought Brass Scalp |
| KEYS: | • Two (2) per Lock |
| KEYWAYS: | • SCC standard (Schlage C Compatible) • Also available in keyways of other manufacturers |
| INTERCHANGEABLE CORE: | • 6 or 7-pin • Compatible with Best, Falcon and Arrow |
| CYLINDER: | • 6-pin Brass Insert Cylinder keyed to 5-pins • Standard High Security and UL437 Cylinders Available |
| KEYING: | • Options: MK, CMK or GMK • Zero Bitted (KO), Keyed Different (KD) or Keyed Alike (KA) • Can be keyed into existing master key systems |
| FINISHES: | • 605 (US3), 606 (US4), 612 (US10), 613E, 622 (US19), 629 (US32), 630 (US32D) |
| CERTIFICATIONS, LISTINGS, COMPLIANCES: | • ANSI "Positive Pressure Fire Tests of Door Assemblies" for up to and including 3 hrs. • Complies with ADA (Americans with Disabilities Act) and ICC/ANSI 117.1 for Accessible and Usable Building • UL 10C listed, 3-hour fire rated as auxiliary locks for A label single doors • UL 10B listed for neutral pressure doors • TAA compliant. Country of origin: KR |
| WARRANTY: | • One (1) year Limited Warranty |

PDQ Functions

| FUNCTION | FUNCTION NUMBER | OUTSIDE INSIDE | DESCRIPTION | ANSI NUMBER |
|---------------------------------|-----------------|------------------|--|-------------|
| Single Cylinder | 116 | | <ul style="list-style-type: none"> Lock or unlock by key from outside, by thumb turn from inside | E2152 |
| Single Sided | 125 | | <ul style="list-style-type: none"> Deadbolt by inside thumb turn only Special door preparation required Surface mounted, 1-3/4" bore hole, one side | E2192 |
| Single Sided | 125 BK | | <ul style="list-style-type: none"> Deadbolt by inside thumb turn only 2-1/8" bore hole, one side | E21112 |
| Single Sided Indicator Deadbolt | 125 IND | | <ul style="list-style-type: none"> No key outside Indicator outside Thumbturn inside extends/retracts deadbolt Emergency key outside retracts deadbolt | — |
| Double Cylinder | 137 | | <ul style="list-style-type: none"> Lock or unlock by key from both sides | E2142 |

How to Order

| QUANTITY | SERIES | FUNCTION | FINISH | BACKSET | CYLINDER | KEYWAY | KEYING | OPTION |
|---|--------|----------|---|---|---|----------|--------|----------------------|
| 20 | KV | 116 | 630 | ADJ | D | SCC | KD | — |
| NOTE: Case quantity is 20 / Case weight is 26 lbs. Single Cylinder / Case weight is 35 lbs. Double Cylinder | | | 605 606 613E 622 626 630 | ADJ — 2-1/4" x 1" (Default) ADJR — 2-1/4" x 1" x 1/4" Radius | D Default L Less Cylinder SF6 Lock is SFIC prepped w/ 6 pin core SF7 Lock is SFIC prepped w/ 7 pin core SFL Lock is SFIC prepped but less core SFC Lock is SFIC prepped w/ construction core SFP Lock is SFIC prepped w/ plastic construction core | PAGE 110 | | DB — Dust Box |
| | | | | PAGE 110 | PAGE 110 | | | PAGE 110 |

Deadbolts

| ANSI NO. | FUNCTION | DESCRIPTION | 626/630 | 605/606/613E 622 | CYLINDER OPTIONS | ICON | LOCK ADJUSTMENT |
|--|----------|---------------------------------|----------|------------------|------------------|------|-----------------|
| NON-CYLINDER - Thumbturn Inside | | | | | | | |
| E2192 | 125 | Communicating | \$55.00 | \$67.00 | D | | N/C |
| E21112 | 125BK | Communicating | | | | | |
| | 125IND | Single Sided Indicator Deadbolt | \$77.00 | \$89.00* | SFL | | |
| SINGLE CYLINDER - Cylinder Outside / Thumbturn Inside | | | | | | | |
| E2152 | 116 | Entrance | \$80.00 | \$92.00 | | | |
| DOUBLE CYLINDER | | | | | | | |
| E2142 | 137** | Store Door | \$102.00 | \$114.00 | | | |

List prices shown include conventional key in knob/lever cylinder. For I-C, list prices do not include core.
 *125IND available in 626, 613E, 630 only **Not available in SFL

NOTES:

- Prices do not include IC Core
- 125 different prep
- 125BK different prep



Backset

| BACKSET DESCRIPTION | 605 | 613E | 622 | 630 | LIST PRICE |
|--|-----------|-----------|----------|-----------|------------|
| <i>2-3/4" - 2-3/8" ADJUSTABLE</i> | | | | | |
| 2-1/4" x 1-1/8" (Default) | I04507-5 | I04507-6 | I04507-H | I04507-1 | \$50.00 |
| 2-1/4" x 1-1/8" x 1/4" Radius | I04507-5R | I04507-6R | I04507-H | I04507-1R | |
| 1-1/8" Latch Front Filler Plate (Minimum of 100 pieces) | I099-100 | | | | \$5.00 |

KV SERIES
DEADBOLT LOCKS

Options

| DESCRIPTION | 605 | 613E | 622 | 630 | LIST PRICE |
|--|---------|---------|---------|---------|------------|
| Deadbolt Strike (any finish) 2-3/4" x 1-1/8" | I4702-5 | I4702-6 | I4702-H | I4702-1 | \$25.00 |
| Dust Box | I4701 | | | | \$8.00 |

Miscellaneous Parts

| DESCRIPTION | PDQ NO. | LIST PRICE |
|---|------------|------------|
| Emergency Release Key for KV125IND Deadbolt | I4711-EKEY | \$5.00 |

MJ SERIES

Heavy Duty Mortise Cylinder Deadbolt



ASSEMBLED
IN THE USA

Typical Applications

- Auxiliary Doors
- Closets
- Commercial/Institutional/Military
- Common Areas
- Equipment Rooms
- Storerooms
- Restrooms
- Privacy Rooms



Specifications

Small Mortise Body Type Prep



| | |
|---|---|
| FOR DOORS: | • 1-3/4" |
| BACKSET: | • 2-3/4" |
| CASE: | • Steel — Dichromated for corrosion resistance |
| FACEPLATE: | • 1-1/4" x 5-5/8" |
| STRIKE: | • 2-1/4" x 1" • Stainless Steel. |
| DEADBOLT: | • 1" Throw. • Stainless Steel. |
| THUMBTURN OPTION: | • ADA Compliant. |
| INDICATOR: | • Vacant/Occupied available. |
| HAND: | • Non-handed except for function MJ134 Classroom. (See Function Table and How to Order Guide). |
| KEYS: | • Two (2) per Lock. |
| KEYWAYS: | • SCC standard (Schlage C Compatible) • Also available in keyways of other manufacturers |
| INTERCHANGEABLE CORE: | • 6 or 7-pin • Compatible with Best, Falcon & Arrow • Large Format IC Cores compatible with Schlage. |
| CYLINDER: | • 6 or 7-pin Mortise Cylinder |
| KEYING: | • Options: MK, CMK or GMK • Zero Bitted (KO), Keyed Different (KD) or Keyed Alike (KA) • Can be keyed into existing master key systems |
| FINISHES: | • 605 (US3), 606 (US4), 612 (US10), 613E, 622 (US19), 629 (US32), 630 (US32D) |
| CERTIFICATIONS, LISTINGS, COMPLIANCES: | • UL listed for 3 hours, for single doors up to 4'0"x 8'0" • TAA compliant. Country of origin: Taiwan |
| WARRANTY: | • 10-Year Limited Warranty |

Cross Reference*

| ANSI # A156.5 (A156.13) | PDQ FUNCTION | BEST | CORBIN | DORMA | MARKS #31/32/33 SERIES | SARGENT | SCHLAGE | YALE |
|-------------------------|--------------|-------|--------|-------|------------------------|---------|---------|------|
| E06081 (F18) | MJ131 | 48H L | DL4111 | D961 | L | 4876 | L464 | 353 |
| E06071 (F17) | MJ132 | 48H K | DL4113 | D960 | K | 4875 | L460 | 352 |
| E06061 (F16) | MJ133 | 48H M | DL4112 | D962 | M | 4874 | L462 | 351 |
| E06091 (F29) | MJ134LH | 48H R | DL4117 | D963 | S | 4877 | L463 | 357 |
| | MJ134LH | | | | | | | |

*Note: Functions are equal, but form may differ.



How to Order

| SERIES | FUNCTION | FINISH | CYLINDER | KEYWAY OR HOUSING | KEYING | OPTIONS |
|--------|----------|---|---|-------------------|--------|--|
| MJ | 131 | 630 | D | SCC | KD | — |
| | | 605 606 612 613E 622 629 630 | D Default L Less Cylinder SF6 Lock is SFIC prepped w/ 6 pin core SF7 Lock is SFIC prepped w/ 7 pin core SFL Lock is SFIC prepped but less core SFC Lock is SFIC prepped w/ construction core SFP Lock is SFIC prepped w/ plastic construction core LF6 Lock is Schlage LFIC prepped w/ Schlage core LFL Lock is Schlage LFIC prepped but less core LFC Lock is Schlage LFIC prepped w/ construction core | | | ADA — Disability Thumbturn (ADA) AM — Antimicrobial Coating |

Mortise Deadbolt

| FUNCTION | FUNCTION NUMBER | OUTSIDE INSIDE | DESCRIPTION | 630 | 605/606/613E/629 630/612/622 |
|---|-----------------|------------------|---|----------|---------------------------------|
| Single Cylinder | 131 | | <ul style="list-style-type: none"> Key outside extends/retracts deadbolt | \$272.00 | \$284.00 |
| Single Cylinder with Thumbturn | 132 | | <ul style="list-style-type: none"> Key outside extends/retracts deadbolt Thumbturn inside extends/retracts deadbolt | \$343.00 | \$355.00 |
| Double Cylinder | 133 | | <ul style="list-style-type: none"> Key outside extends/retracts deadbolt Key inside extends/retracts deadbolt | \$399.00 | \$411.00 |
| Single Cylinder (Classroom) Left Hand | 134LH | | <ul style="list-style-type: none"> Key outside extends/retracts deadbolt Inside cylinder turn retracts but does not extend deadbolt Thumbturn rotates clockwise | \$373.00 | \$385.00 |
| Single Cylinder (Classroom) Right Hand | 134RH | | <ul style="list-style-type: none"> Key outside extends/retracts deadbolt Inside cylinder turn retracts but does not extend deadbolt Thumbturn rotates counter-clockwise | | |
| Single Cylinder w/Indicator (Privacy) | 232 | | <ul style="list-style-type: none"> Key outside extends/retracts deadbolt Thumb turn inside extends/retracts deadbolt Indicator outside displays: <ul style="list-style-type: none"> Occupied when deadbolt is projected Vacant when deadbolt is retracted Indicator, outside — (VACANT/OCCUPIED) | \$452.00 | \$464.00 |

Note: For replacement T-Turn mortise cylinders for functions MJ134 RH and MJ134 LH, see the Cylinders and Keying Section.

Options

| CODE | DESCRIPTION | LIST PRICE |
|------|---|------------|
| ADA | Disability Thumbturn (ADA) | \$21.00 |
| AM | Antimicrobial Coating (Not available with 605 finish) | \$37.00 |



ADA Thumbturn



PL-1 IC PADLOCK

Solid brass padlock with hardened steel shackle, accepts standard 6 or 7 pin SFIC lock cylinders (sold separately).

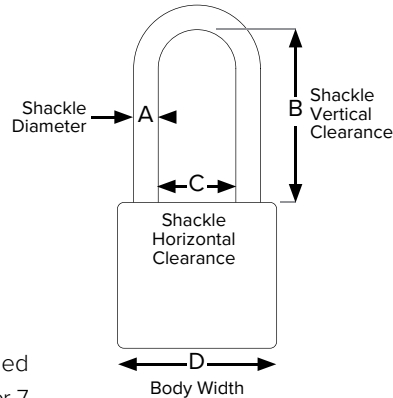

SHACKLE DIMENSIONS

Typical Applications

- Gates
- Higher Education
- Industrial
- K-12 Education

Shackle Size

| A DIAMETER | B VERTICAL CLEARANCE | C HORIZONTAL CLEARANCE | D BODY WIDTH |
|---------------|----------------------------|------------------------------|--------------------|
| 5/16" | 1-1/8" | 25/32" | 1-3/4" |

How to Order

| QUANTITY | SERIES | FUNCTION | KEYWAY | KEYING | OPTION |
|----------|--------|----------|--------|--------|---------------------|
| 10 | PL | 1 | PDQ1 | KD | — |
| | | | | | CC — Chain & Clevis |

NOTE: Case quantity is 10 / Case weight varies

Padlocks

| FUNCTION | DESCRIPTION | SHACKLE | PDQ NO. | LIST PRICE |
|----------|-----------------|-----------------|---------|------------|
| 1 | PL-1 IC Padlock | 1-3/4" x 1-1/8" | I8512-7 | \$42.00 |

NOTES:
• Prices do not include IC Core

Options

| CODE | DESCRIPTION | PDQ NO. | LIST PRICE |
|------|----------------|---------|------------|
| CC | Chain & Clevis | I8512 | \$12.00 |

Cores

| DESCRIPTION | PDQ NO. | ADD |
|---|-----------------------------|------------|
| SMALL FORMAT UNCOMBINATED | | |
| 6 Pin Cores | I5206 + KEYWAY (I5206-A) | \$40.00 |
| 7 Pin Cores | I5207 + KEYWAY (I5207-B) | |
| COMBINATED | | |
| 6 Pin Cores | I5206-1 + KEYWAY (I5206-1A) | \$60.00 |
| 7 Pin Cores | I5207-1 + KEYWAY (I5207-1B) | |
| A (DEFAULT), B, C, D, E, F, G, H, J, K, L, M, Q, WA, WB, WC, WG, WH, TB, TD, TE, & R | | |
| CONSTRUCTION CORES | | |
| Construction Core 6-pin only | | \$60.00 |
| Dummy Construction Core Plastic Construction cores are invoiced at shipment and credited upon return. Subject to 50% discount. | | \$8.00 |
| VISUAL KEY CONTROL | | LIST PRICE |
| Cylinder Marking AA1, AA2, Etc. (Per Cylinder) | | \$10.00 |
| Key Marking AA1, AA2, Etc. (Per Key) | | |
| Key Marking other than Keyset (Per Key) | | |

NOTES:

- IC Cores are available
Combinated or Uncombinated
- Uncombinated cores do not include springs & pins
- Combinated cores includes master keying
- Designate finish for IC Cores ordered separately: 606 or 626

Features

- PDQ EPIC Series cylinders include a special format interchangeable core to retrofit into standard European Profile applications.
- Solid brass construction
- Can be incorporated into existing master key system
- Large thumbturn for ease of use
- EPIC Cores receive special machining to interface with housing. Specify (EP) designator for these cores (example: I5206EP-A)



EPIC SERIES

| PDQ NO. | DESCRIPTION | LIST PRICE |
|----------|--|------------|
| I5131 | EPIC, Single Cylinder 45MM | \$222.00 |
| I5131L | EPIC, Single Cylinder 55MM | \$245.00 |
| I5132 | EPIC, Single Cylinder X Turn 45MM/40MM | \$260.00 |
| I5132LIS | EPIC, Single Cylinder X Turn 45MM/55MM | \$282.00 |
| I5132LOS | EPIC, Single Cylinder X Turn 55MM/45MM | |
| I5133 | EPIC, Double Cylinder 45MM/45MM | \$260.00 |
| I5133L | EPIC, Double Cylinder 55MM/45MM | \$292.00 |

Cores

| DESCRIPTION | PDQ NO. | ADD |
|---|-------------------------------|------------|
| SMALL FORMAT UNCOMBINATED | | |
| 6 Pin Cores | I5206 + KEYWAY (I5206EP-A) | \$150.00 |
| 7 Pin Cores | I5207 + KEYWAY (I5207EP-B) | |
| COMBINATED | | |
| 6 Pin Cores | I5206-1 + KEYWAY (I5206EP-1A) | \$180.00 |
| 7 Pin Cores | I5207-1 + KEYWAY (I5207EP-1B) | |
| A (DEFAULT), B, C, D, E, F, G, H, J, K, L, M, Q, WA, WB, WC, WG, WH, TB, TD, TE, & R | | |
| CONSTRUCTION CORES | | |
| Construction Core 6-pin only | | \$150.00 |
| Dummy Construction Core Plastic Construction cores are invoiced at shipment and credited upon return. Subject to 50% discount. | | \$6.00 |
| VISUAL KEY CONTROL | | LIST PRICE |
| Cylinder Marking AA1, AA2, Etc. (Per Cylinder) | | \$10.00 |
| Key Marking AA1, AA2, Etc. (Per Key) | | |
| Key Marking other than Keyset (Per Key) | | |

NOTES:

- IC Cores are available Combined or Uncombined
- Uncombined cores do not include springs & pins
- Combined cores includes master keying
- Designate finish for IC Cores ordered separately: 606 or 626

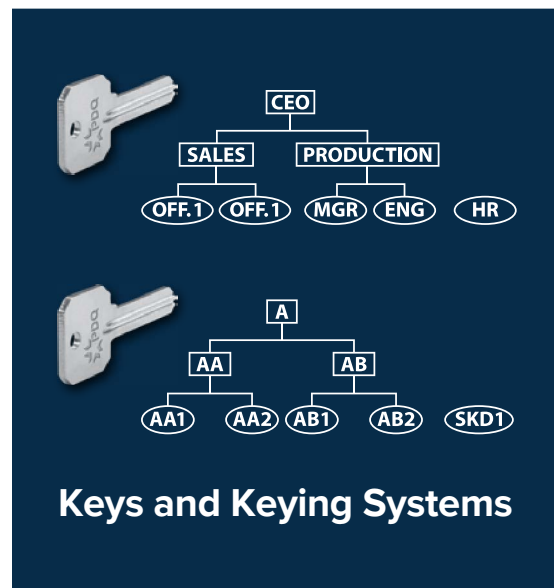

HIGH SECURITY

LIST PRICE

Effective July 3, 2023

Standard High Security Cylinders

| DESCRIPTION | PDQ NO. | 626 | 605 | 613E |
|---|---------|----------|----------|------|
| 6 Pin Key in Knob/Lever Cylinder KD/KA | HSC125 | \$86.00 | \$106.00 | — |
| Mortise/Rim Combo Cylinder 1-1/8" 6 Pin KD/KA | HSC020 | \$118.00 | \$138.00 | |
| Mortise Cylinder 1 1/4" 6 Pin KD/KA | HSC030 | | | |
| Mortise Cylinder 1 1/2" 6 Pin KD/KA | HSC050 | \$150.00 | — | |

Includes 2 Cut Keys. NOTE: Requires master keying, see below for charge.

NOTES:

- Prices for LFIC Mortise & Rim Cylinder Housings do not include IC Core
- Specify finish when ordering IC Housing & Cores
- High Security Cylinders not available "0" bitted.
- Key blanks for High Security Cylinders not available.

UL437 High Security Cylinders

| DESCRIPTION | PDQ NO. | 626 | 605 | 613E |
|--|---------|----------|----------|------|
| UL 437 6 Pin Key in Knob/Lever Cylinder KD/KA | HSC425 | \$105.00 | \$139.00 | — |
| UL 437 Mortise Rim Combo Cylinder 1-1/8" KD/KA | HSC320 | \$140.00 | \$174.00 | |
| UL 437 Mortise Cylinder 1-1/4" KD/KA | HSC330 | | | |

Includes 2 Cut Keys. NOTE: Requires master keying, see below for charge.

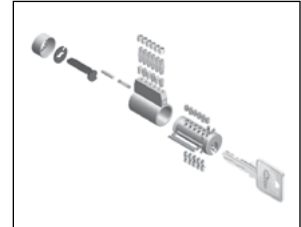

High Security Cylinder

High Security Keying Systems

| DESCRIPTION | PDQ NO. | LIST PRICE |
|------------------------------------|---------|------------|
| Cut Key, 6 pin | HSC065 | \$15.00 |
| SFIC Cut Key, IC 7 pin | HSC874 | |
| LFIC Control Cut Key, IC 6 pin, TA | HSC965 | |
| Master Keying Charge | | \$24.00 |
| Key Marking Charge | | \$6.00 |
| Cylinder Marking Charge | | \$12.00 |



Key in Knob/Lever Cylinder

High Security Cores

| DESCRIPTION | PDQ NO. | 626 |
|--|---------|----------|
| SFIC Cylinder, 6 Pin | HSC806 | \$118.00 |
| SFIC Cylinder, 7 Pin | HSC807 | \$128.00 |
| LFIC Cylinder Schlage® compatible, 6 Pin | HSC906 | \$172.00 |

Includes Keying Charges and 2 Cut Keys

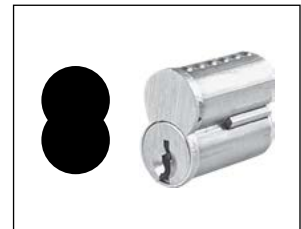

High Security Cams

| DESCRIPTION | PDQ NO. | LIST PRICE |
|-------------------------|----------|------------|
| Adams Rite Type Cam | HSCCAM1 | \$9.00 |
| Yale Type Cam | HSCCAM2 | |
| Yale Narrow Type Cam | HSCCAM2A | |
| Russwin Type Cam | HSCCAM3 | |
| Falcon Type Cam | HSCCAM4 | |
| Schlage Type Cam | HSCCAM7 | |
| Sargent Offset Type Cam | HSCCAM8 | |
| PDQ Cam | HSCCAM3 | |



UL 437 and High Security Cylinders



Conventional

Conventional Cylinders

PDQ's high quality conventional cylinders provide the standard level of security and functionality.

Interchangeable Core (IC) cylinders

Interchangeable core (IC) offers maximum flexibility to the building owner. Whenever a key is lost or stolen, locks can be rekeyed quickly by non-locksmith personnel. All it takes is the special "control" key. This key is used to remove and install all cores in the system. Just go to the door, remove the old core and install the new one with the control key. Security is regained in seconds! Unlike most other brands, PDQ interchangeable cores can always be integrated into existing systems with no adverse effect on the key system. IC cylinders are available in two sizes:



SFIC

Small Format Interchangeable Core (SFIC)

Based on a plug diameter smaller than the standard 1/2", SFIC cores are interchangeable with other SFIC installations.



LFIC

Large Format Interchangeable Core (LFIC)

Based on the industry standard plug diameter of 1/2", PDQ large format interchangeable cores (LFIC) are available for a variety of different key system types from standard and basic, to restricted and high security.



High security
key in knob cylinder

Standard High Security Cylinders

Conventional Key in Knob

Interchangeable Core - SFIC and LFIC

PDQ High Security cylinders are available in a number of formats, including the standard, KIK (Key In Knob/lever) cylinder used in most PDQ cylindrical locks, as well as a unique Mortise/Rim Cylinder that can be used in either configuration. All standard High Security cylinders feature 2 hardened anti-drill pins as well as our unique and proprietary PDQ keyway with sidebar.



High security
SFIC and LFIC cores
(SFIC shown)



UL 437
High Security Cylinders

UL 437 High Security Cylinders **437**

For additional security, PDQ offers select cylinders in a UL437 package. These optional cylinders feature a minimum of 11 anti-drill, stainless steel pins and UL437 certification. UL437 available in all mortise, mortise rim and KIK keyed functions.

Conventional Key in Knob/Lever Cylinders



| KEYWAY | CODE | 606 | 626 | LIST PRICE |
|----------------------------|---------------|------------|------------|------------|
| PDQ TA (Restricted) | TA | V90504-844 | V90504-744 | \$78.00 |
| Arrow AR1 | AR1 | V90504-830 | V90504-730 | |
| Corbin 59A1 | CO59A1 | V90504-829 | V90504-729 | |
| Corbin 60 | CO6 | V90504-819 | V90504-719 | |
| Corbin L4 | CL4 | V90504-822 | V90504-722 | |
| Falcon E-R | FAL | V90504-833 | V90504-733 | |
| Kwikset | KW | V90504-850 | V90504-750 | |
| Russwin 981 | RUD981 | V90504-821 | V90504-721 | |
| Russwin D1 | RUD | V90504-820 | V90504-720 | |
| Sargent LA | SAL | V90504-805 | V90504-705 | |
| Sargent RA-RC | RA-RC | V90504-806 | V90504-706 | |
| Schlage C (Default) | SCC (Default) | V4802-8 | V4802-7 | |
| Schlage C-K | SCC-K | V90504-818 | V90504-718 | |
| Schlage E | SCE | V90504-817 | V90504-717 | |
| Yale E1R | YA8 | V90504-831 | V90504-731 | |
| Yale GA | GA | V90504-835 | V90504-735 | |

NOTES:

- Specify finish for cylinders
- Specify KD, KA4, or 1 bitted
- 6 pin cylinder keyed for 5 pin
- Specify lock series.
Example: GT, SD, etc.

CYLINDERS

LIST PRICE

Effective July 3, 2023

Rim Cylinders



| KEYWAY | CODE | 605 | 606 | 612 | 613E | 625 | 626 | LIST PRICE |
|----------------------------|---------------|-------------|-------------|-------------|-------------|-------------|-------------|------------|
| PDQ TA (Restricted) | TA | I01705-6044 | I01708-6044 | I01703-6044 | I01706-6044 | I01702-6044 | I01707-6044 | \$84.00 |
| Arrow AR1 | AR1 | I01705-6030 | I01708-6030 | I01703-6030 | I01706-6030 | I01702-6030 | I01707-6030 | |
| Corbin 59A1 | CO59A1 | I01705-6029 | I01708-6029 | I01703-6029 | I01706-6029 | I01702-6029 | I01707-6029 | |
| Corbin 60 | CO6 | I01705-6019 | I01708-6019 | I01703-6019 | I01706-6019 | I01702-6019 | I01707-6019 | |
| Corbin L4 | CL4 | I01705-6022 | I01708-6022 | I01703-6022 | I01706-6022 | I01702-6022 | I01707-6022 | |
| Falcon E-R | FAL | I01705-6033 | I01708-6033 | I01703-6033 | I01706-6033 | I01702-6033 | I01707-6033 | |
| Kwikset | KW | I01705-6050 | I01708-6050 | I01703-6050 | I01706-6050 | I01702-6050 | I01707-6050 | |
| Russwin 981 | RUD981 | I01705-6021 | I01708-6021 | I01703-6021 | I01706-6021 | I01702-6021 | I01707-6021 | |
| Russwin D1 | RUD | I01705-6020 | I01708-6020 | I01703-6020 | I01706-6020 | I01702-6020 | I01707-6020 | |
| Sargent LA | SAL | I01705-605 | I01708-605 | I01703-605 | I01706-605 | I01702-605 | I01707-605 | |
| Sargent RA-RC | RA-RC | I01705-606 | I01708-606 | I01703-606 | I01706-606 | I01702-606 | I01707-606 | |
| Schlage C (Default) | SCC (Default) | I01705-6016 | I01708-6016 | I01703-6016 | I01706-6016 | I01702-6016 | I01707-6016 | |
| Schlage C-K | SCC-K | I01705-6018 | I01708-6018 | I01703-6018 | I01706-6018 | I01702-6018 | I01707-6018 | |
| Schlage E | SCE | I01705-6017 | I01708-6017 | I01703-6017 | I01706-6017 | I01702-6017 | I01707-6017 | |
| Yale E1R | YA8 | I01705-6031 | I01708-6031 | I01703-6031 | I01706-6031 | I01702-6031 | I01707-6031 | |
| Yale GA | GA | I01705-6035 | I01708-6035 | I01703-6035 | I01706-6035 | I01702-6035 | I01707-6035 | |
| ----- | Dummy | I01705-60D | I01708-60D | I01703-60D | I01706-60D | I01702-60D | I01707-60D | |

INTERCHANGEABLE CORES

LIST PRICE
Effective July 3, 2023



Interchangeable Cores

| CORE TYPE | KEYWAY | PDQ KEYWAY | ADD | PINS | 606 | 626 |
|--|--|---|----------------|-------------|-----------------------------|-----------------------------|
| Small Format (SFIC) BEST Compatible | UNCOMBINATED | | | | | |
| | Best A (Default), B, C, D, E, F, G, H, J, K, L, M, Q, R, WA, WB, WG, WH, TB, TD, TE, R | A (Default), B, C, D, E, F, G, H, J, K, L, M, Q, R, WA, WB, WG, WH, TB, TD, TE, R | \$40.00 | 6 | I5206 - 8 - Specify Keyway | I5206 - 7 - Specify Keyway |
| | | | | 7 | I5207 - 8 - Specify Keyway | I5207 - 7 - Specify Keyway |
| | COMBINATED | | | | | |
| | Best A (Default), B, C, D, E, F, G, H, J, K, L, M, Q, R, WA, WB, WG, WH, TB, TD, TE, R | A (Default), B, C, D, E, F, G, H, J, K, L, M, Q, R, WA, WB, WG, WH, TB, TD, TE, R | \$60.00 | 6 | I5206 - 8-1- Specify Keyway | I5206 - 7-1- Specify Keyway |
| | | | | 7 | I5207 - 8-1- Specify Keyway | I5207 - 7-1- Specify Keyway |
| | PDQ Exclusive | PDQ 1 | \$60.00 | 6 | I5206 - 8 - 41 | I5206 - 7 - 41 |
| | | PDQ 2 | | 7 | I5207 - 8 - 41 | I5207 - 7 - 41 |
| | PDQ Exclusive and Restricted | PDQ 3 | \$60.00 | 6 | I5206 - 8 - 42 | I5206 - 7 - 42 |
| | | | | 7 | I5207 - 8 - 42 | I5207 - 7 - 42 |
| Large Format (LFIC) Schlage Compatible | UNCOMBINATED | | | | | |
| | Schlage C (Default) | SCC (Default) | \$50.00 | 6 | I5206-8-16 | I5206-7-16 |
| | COMBINATED | | | | | |
| Schlage C (Default) | SCC (Default) | \$70.00 | 6 | I5206-8-116 | I5206-7-116 | |
| | | | PDQ Restricted | TA | — | See High Security Section |
| Construction Cores ¹ | Small Format ² (BEST Compatible) | — | \$60.00 | 6 only | I5206 | I5206 |
| | Dummy, Plastic | — | \$8.00 | — | I13520 | I13520 |
| | Large Format (Schlage Compatible) | — | \$70.00 | — | I5206LFIC | I5206LFIC |
| | I-C Tailpiece and Spacer | — | \$10.00 | — | VP92905 | VP92905 |







Notes 1: No finish designation required. 2: Available in "L" keyway only.



Housings

| DESCRIPTION | PDQ NO. | LIST PRICE |
|--|-----------------------------------|------------|
| SFIC Mortise Cylinder Housing 6-pin 1-1/4", BEST [®] compatible | I5306-(specify finish) | \$75.00 |
| SFIC Mortise Cylinder Housing 7-pin 1-3/8", BEST [®] compatible | I5307-(specify finish) | |
| SFIC Mortise Cylinder Housing (for both 6-pin/7-pin cores), 1-1/2", BEST [®] compatible | I5317-(specify finish) | |
| SFIC Mortise Cylinder Tapered 6-pin 1/2", BEST [®] compatible | I53013-067 (specify US3 or 26D) | |
| SFIC Mortise Cylinder Tapered 7-pin 1/2", BEST [®] compatible | I53013-077 (specify US10B or 26D) | |
| SFIC Rim Cylinder Housing (for both 6-pin/7-pin cores) | I5308-(specify finish) | \$90.00 |
| LFIC Mortise Housing, Schlage [®] compatible | I5304-(specify finish) | |
| LFIC Rim Housing, Schlage [®] compatible | I5303-(specify finish) | |

Cams

| CAM LAYOUT | DESCRIPTION | WHERE USED | CONVENTIONAL MORTISE CYLINDER | SMALL FORMAT HOUSING | LARGE FORMAT HOUSING | LIST PRICE |
|---|------------------------|---|-------------------------------|----------------------|----------------------|------------|
|  | Adams Rite AR Cam | KT Series Deadbolts | 1127-4205 | 154011 | 154211 | \$9.00 |
|  | PDQ MR Cam | MR Series Mortise Locks | 1127-4201 | 154061 | 154261 | |
|  | Straight Cam | 6 EW Series Wide Stile Escutcheon Exit Device Trim | 1127-4202 | 154031 | 154231 | |
|  | Schlage Cloverleaf Cam | | 1127-4209 | 154051 | 154221 | |
|  | Sargent Std Cam | | 1127-4204 | 154041 | N/A | |
|  | Lockwood | | 1127-4203 | 154021 | N/A | |

Keyways



Standard (Open) Keyways

Best suited for applications where fast and easy key duplication is required and low key control is required.



Exclusive Keyways (PDQ1, PDQ2)

PDQ offers two exclusive key systems that utilize key blanks that are very hard to find in the marketplace, thereby reducing the chances of unauthorized duplication.



Restricted Keyways (TA, PDQ3)

The PDQ restricted keyway is only available from PDQ and is shipped directly to the authorized end user. Restricted key systems are ideal when there is a significant need to eliminate an unauthorized duplication by lock shops, hardware and home centers. They provide a higher level of security, with authorization required for the order of key blanks for duplication. Each key is registered and no blank keys are sold. A letter of authorization on the end user's stationery must be submitted with the initial order to establish the authorized ship to location.

Key Blanks

Conventional



Large Bow

Ideal for special keys which must be visibly distinctive within a key system, or for very specialized marking.



Only available in Schlage C

Interchangeable Core



Construction Cores

Temporary construction cores are an excellent way to ensure the security of a construction site. Another more secure way to ensure the security of the construction site is the use of temporary cores. PDQ offers both standard and disposable construction cores for this purpose. The standard cores are painted black above the keyway identifying them as construction cores. These can be returned at job's end for a full credit. Disposable cores are not key lockable and are discarded when the job is complete.

Construction Master Keying (CMK):

PDQ offers the CMK keying option which provides extra security during the transition from the construction phase to completion. A construction master key operates all PDQ cylinders while the building is under construction. Upon completion of the construction phase, it can be voided without removing the cylinders from the locks simply by turning the change key in each cylinder.

KEYING SYSTEMS

LIST PRICE
Effective July 3, 2023

| CODE | KEYING SYSTEMS | LIST PRICE |
|-------------|---|--------------|
| KD | Keyed Random | N/C |
| OB | 0-Bitted with 2 blank keys (For quality control purposes, PDQ "0" bit cylinders are actually keyed to a 1 bit and a 1 bit key is sent to open cylinders.) | |
| KA2 | Keyed Alike, 2 or less (KA2) | |
| KA4 | Keyed Alike, 3-4 (KA3 or KA4) | \$14.00 each |
| KA | Keyed Alike, 5 or More (KA5) | |
| MK | Master Keyed | \$24.00 each |
| KE | Master Keyed to Existing Bittings: | |
| CMK | Construction Master Keyed | \$42.00 each |
| CODE | MASTER KEY SERVICES | |
| | Number of Bittings | |
| B100 | 1-100 | \$125.00 |
| B300 | 101-300 | \$190.00 |
| B1000 | 301-1000 | \$275.00 |
| B2000 | 1001- 2000 | \$375.00 |
| B5000 | 2001- 5000 | \$475.00 |
| | Master Key Service is a custom master key system that is provided with the purchase of complete PDQ manufactured locks and locking devices. A master key service charge will be assessed for any order that includes only PDQ cylinders or cores for use on non-PDQ locks or locking devices. | |
| BL | Bitting List for Factory Master Key Production | \$110.00 |
| CODE | VISUAL KEY CONTROL | |
| VKC-KEY | Visual Key Control - Key Stamping | \$6.00 |
| VKC-CYL | Visual Key Control - Cylinder Stamping | \$12.00 |
| VKC-COR | Visual Key Control - Core Stamping | |
| CODE | KEY CUT CHARGE – MASTER/CONTROL/CHANGE | |
| MKC | Master Key | \$15.00 |
| GMKC | Grand Master Key | |
| GGMKC | Great Grand Master Key | |
| CMKC | Construction Master Key | |
| CTLK | Control Key | |
| CKC | Change Key | |
| CODE | EXTRA KEY CUTS | |
| IO 24 05-00 | Extra Key Cuts | |



Visual Key Control

LOCK AND KEY PARTS

LIST PRICE

Effective July 3, 2023

Key Blanks (50 Piece Minimum Order)

| PDQ KEYWAY | COMPATIBLE WITH | LIST PRICE | |
|--|--|------------|-------------------|
| | | 5-PIN | 6-PIN |
| ARA | Arrow / AR1 | \$4.00 | |
| CO59A1 | Corbin 59A1 | | |
| CO6 | Corbin / 60 | | |
| CL4 | Corbin / L4 | | |
| RUD | Russwin / D1 | | |
| SCC | Schlage / C | | |
| SCE | Schlage / E | | |
| SAL | Sargent / LA | | |
| SAS | Sargent / SAS | | |
| RA-RC | Sargent / RA-RC | | |
| YA8 | Yale / E11 | | |
| GA | Yale / GA | | |
| FAL | Falcon / E-R | | |
| KW | Kwikset / KW | | |
| TA | PDQ / TA (Restricted. Limited to Grandmaster systems w/4 sub masters) | | |
| Large Bow Key | SCC | | |
| Large Bow Key | SCE | | |
| INTERCHANGEABLE CORE KEY BLANKS | | | PRICE EACH |
| Best Keyways: A, B, C, D, E, F, G, H, J, K, L, M, Q, WA, WB, WC, WD, WG, WH, TB, TD, TE, R, DD | | | \$5.00 |
| IC Keyblank Stamped "U.S. Govt". Min order qty: 50ea | | | \$6.00 |

NOTES:

- Specify finish when ordering miscellaneous parts
- Kwikset cylinder available in 5 pin only



6 Pin Key Blank / 5 Pin Key Blank



Collars

IC Key blanks are stamped DND prohibiting duplication as standard. Unmarked blanks are available upon request.

Miscellaneous Parts

| DESCRIPTION | PDQ NO. | LIST PRICE |
|---|------------------|------------|
| 1-1/4" x 4-7/8" ANSI Dust Box (Specified with Lock) | Y025-SBX | \$8.00 |
| 1-1/4" x 4-7/8" ANSI Dust Box | Y025-SBX | |
| T-Strike Dust Box (Specified with Lock) | I0251 | |
| T-Strike Dust Box | I0251 | |
| FL-Strike Dust Box (Specified with Lock) | I0251R | |
| FL-Strike Dust Box | I0251R | |
| 1-1/8" x 2-3/4" Deadbolt Dust Box | I4701 | |
| IC Tailpiece assembly includes tailpiece and spacer | VP92905 | \$10.00 |
| GP Screw pack (any finish) / GT Screw pack (any finish) | V91910 / VA10030 | \$8.00 |
| 1-1/8" Latch Front Filler Plate (Minimum of 100 pieces) | I099-100 | \$2.00 |
| COLLARS AND BLOCKING RINGS | | |
| Rim Cylinder Ring | I5502 | \$4.00 |
| Mortise Cylinder Ring Step 5/32" | I5501 | |
| Blocking Ring 1/8" | I55121 | |
| Blocking Ring 5/32" | I034 | |
| Blocking Ring 1/4" | I55012 | \$17.00 |
| Vandal Collar 11/16" | I5504 | |
| Vandal Collar 13/16" | I5503 | |



SFIC Tailpieces

*Works with both GP and GT, SX and SD latches. (Grade 1 latches requires removal of breakaway center)

Security. Performance. Flexibility.

Exit devices are a critical part of a building's fire and life safety egress system. PDQ manufactures a full line of exit devices, including rim, vertical rod and mortise for both wide and narrow stile doors. These devices provide the best combination of simplicity, strength, durability, aesthetics, and innovation and are perfect for a vast array of applications.

Comprehensive Offering

6300
Architectural Wide Stile



Applications

The all NEW 6300 Series Wide Stile Exit Devices incorporate modern push bar styling for heavy traffic applications. These Grade 1 certified devices are put to the ultimate test everyday in K-12, higher education, Healthcare, and government buildings. Other applications include offices, banks, assisted living facilities, retail stores, and other commercial buildings that have constant traffic.

6400
Architectural Narrow Stile



Applications

The all NEW 6400 Series Wide Stile Exit Devices incorporate modern push bar styling for heavy traffic applications. These Grade 1 certified devices are put to the ultimate test everyday in K-12, higher education, Healthcare, and government buildings. Other applications include offices, banks, assisted living facilities, retail stores, and other commercial buildings that have constant traffic.

4200
Commercial Wide Stile



Applications

When low cost and dependability are essential, the 4200 Series is a great choice. A reliable workhorse, the 4200 Series is an economical answer for stock doors and frames.

9300
Mullions



Applications

Designed for quick removal, the 9300 mullion is ideal in situations where carts, gurneys and large machinery need to pass freely through an opening. Popular applications include Healthcare, industrial manufacturing, and commercial businesses.



6300/6400 SERIES

Architectural Exit Device

Highlights

Chassis support is cast for high strength.

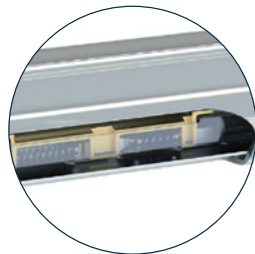
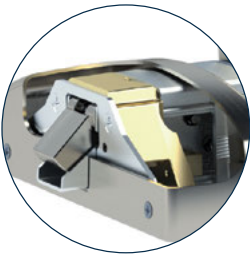

Push bar has angled ends and is nearly flush when dogged.

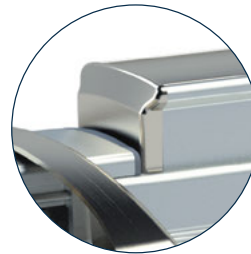

Cush spring quiets device in both directions. Compression spring returns the touch bar providing more reliability than a torsion type spring.

Flush end cap is standard, heavy duty engineered casting keys into the rail for ultimate pry resistance.

Features

- Rugged, reliable, flexible, and simple design
- Designed & Assembled in Lancaster, PA
- Patent Pending
- Quiet operation - large heavy-duty spring cushion quiets both the compression/extension of the push bar
- Internal compression spring ensures long lasting push bar return
- Engineered strong and overbuilt for the most demanding environments
- Durable, heavy-duty flush end cap is standard and resist prying
- Stands up to cart abuse, heavy-duty flush end cap and tapered push bar designed to deflect hits and minimize damage
- Simple field door prep and installation
- Dogging holds bar in a retracted position nearly flush with head cover and rail
- Hex Key provided to dog/release the device
- No exposed screws on back of bar
- True 2-3/4" backset (with 5/8" frame stop and 1/8" door gap)
- Wood and machine screws included with each device
- Devices and trim are non-handed
- Ten (10) year warranty



Rim
6300R / 6400R



Surface Vertical Rod
6300V / 6400V



Concealed Vertical Rod
6300C / 6400C



Mortise
6300M

6300/6400R SERIES

Wide/Narrow Stile Rim Exit Device



ASSEMBLED
IN THE USA

6300R Wide Stile/6400R Narrow Stile Panic & Fire Rated



Specifications



| | |
|---|--|
| Rail | • Extruded aluminum |
| Latch | • Stainless steel dead locking with 3/4" throw |
| Hand | • Device is non-handed • Trim is non-handed or field reversible |
| Dogging | • Hex key dogging standard • Cylinder dogging optional • Dogging not available for fire labeled devices |
| Minimum Stile Width | • 6300 - 3-1/2" • 6400 - 3 1/8" with 639027/639057 strike and 2 1/8" on aluminum frames with blade stop strike. |
| Door Thickness | • 1-3/4" - 2" (Consult factory for other) |
| Door Width | • 24", 36", 48" standard |
| Door Height | • Panic - Up to 10' • Fire - See fire ratings charts page 146 |
| Strike Options | • Roller (Default) • Blade stop • Double door • Windstorm/Fire Mullion - Panic Mullion uses standard roller strike |
| Finishes | • 605 - Polished Brass, 606 - Satin Brass, 613E - Dark Bronze, 622 - Flat Black, 626 - Satin Chrome, 630 - Satin Stainless Steel, 630F - Full Stainless Steel • Optional Anti Microbial Coating available on 626, 630 |
| Fasteners | • Includes machine and wood screws • SNB Optional |
| Warranty | • Ten (10) year limited warranty |
| Electrified Options | • Motorized Latch Retraction • Request to Exit/Signal Switch • Alarmed Exit • Latch Bolt Monitor • ISMC Connectors • Delayed Egress |
| Certifications: Compliances: Listings: | • Listed for UL 305 "Panic", listed for UL 10C "Fire Exit Hardware" up to 3 hours. • Certified to ANSI/BHMA A156.3 Grade 1 • FL #40297 +60/-65 psf 4080 16ga Single • FL #40297 +50/-50 psf 4080 18ga Single • Complies with ADA (Americans with Disabilities Act) and ICC/ANSI 117.1 for Accessible and Usable Buildings • Meets requirements of the BAA as a COTS product manufactured in the United States |

6300/6400 RIM EXIT DEVICE

LIST PRICE
Effective July 3, 2023

6300/6400
RIM EXIT DEVICE

How to Order

| Series | For Door Width | Device Type | Rating | Finish | Options | Electrified Options |
|--|--|-----------------------|---|---|--|--|
| 63 | 00 | R | -- | 630 | -- | -- |
| 63 - Wide Stile Device 64 - Narrow Stile Device | 00 - 36" Door 10 - 48" Door 20 - 24" Door | R - Rim Device | Blank - Panic Rated F - Fire Rated | 605 – Bright Brass 606 – Satin Brass 613E – Dark Bronze 622 – Satin Black 625 – Bright Chrome 626 – Satin Chrome 630 – Satin Stainless 630F – Full Stainless | Dogging (Panic Rated Only): Blank - Hex Key Dogging CD - Cylinder Dogging LD - Less Dogging* Strikes: BS - Blade Stop Strike (Rim) DD - Double Door Strike (Rim) DE - Delayed Egress WS – Windstorm Rated (Rim & SVR) EC - End Cap Cover TLA - Head Cover SNB - Sex Nuts & Bolts AM - Anti-Microbial SK - Shim Kit SHS - Security Head Screws | MLR - Motorized Latch Retr. AL - Alarm Kit* SS - Signal Switch on touch bar LM - Latchbolt Monitor ISMC - Industry Standard Molex Connector ALHW - Alarm kit hard wired DE - Delayed Egress |

*Multiple Selections Allowed
 *Dogging options only apply to Panic Rated
 *MLR can be combined with LM & SS
 *AL can be combined with LM
 *MLR and AL cannot be combined
 *ISMC available on all
 *AL - specify handing

6300R Rim Wide Stile Exit Devices

| PART | DESCRIPTION | 630 | 613E/622/626 | 605/606/625 | 630F |
|--------|--|-----------|--------------|-------------|-----------|
| 6300R | Rim, Listed to UL305 for Panic, hex key dogging, 3'0" door | \$900.00 | \$943.00 | \$1035.00 | \$1075.00 |
| 6300RF | Rim, Listed to UL10C for Fire, no dogging 3'0" door | \$1062.00 | \$1105.00 | \$1197.00 | \$1237.00 |
| 6310R | Rim, Listed to UL305 for Panic, hex key dogging, 4'0" door | \$946.00 | \$989.00 | \$1081.00 | \$1121.00 |
| 6310RF | Rim, Listed to UL10C for Fire, no dogging 4'0" door | \$1108.00 | \$1151.00 | \$1243.00 | \$1283.00 |
| 6320R | Rim, Listed to UL305 for Panic, no dogging, 2'0" door | \$1000.00 | \$1043.00 | \$1135.00 | \$1175.00 |
| 6320RF | Rim, Listed to UL10C for Fire, no dogging 2'0" door | \$1162.00 | \$1205.00 | \$1297.00 | \$1337.00 |

Available with all electrified options.

6400R Rim Narrow Stile Exit Devices

| PART | DESCRIPTION | 630 | 613E/622/626 | 605/606/625 | 630F |
|--------|--|-----------|--------------|-------------|--------|
| 6400R | Rim, Listed to UL305 for Panic, hex key dogging, 3'0" door | \$983.00 | \$1026.00 | \$1118.00 | \$1158 |
| 6400RF | Rim, Listed to UL10C for Fire, no dogging 3'0" door | \$1145.00 | \$1188.00 | \$1280.00 | \$1320 |
| 6410R | Rim, Listed to UL305 for Panic, hex key dogging, 4'0" door | \$1029.00 | \$1072.00 | \$1164.00 | \$1204 |
| 6410RF | Rim, Listed to UL10C for Fire, no dogging 4'0" door | \$1191.00 | \$1234.00 | \$1326.00 | \$1366 |
| 6420R | Rim, Listed to UL305 for Panic, no dogging, 2'0" door | \$1083.00 | \$1126.00 | \$1218.00 | \$1258 |
| 6420RF | Rim, Listed to UL10C for Fire, no dogging 2'0" door | \$1245.00 | \$1288.00 | \$1380.00 | \$1420 |

6300/6400 RIM EXIT DEVICE

LIST PRICE

Effective July 3, 2023

6300/6400R Rim Mechanical Options

| PART | DESCRIPTION | EXIT DEVICE ADJUSTMENT |
|------|-------------------------------------|------------------------|
| EC | End Cap Cover | \$26.00 |
| TLA | Head Cover (Similar to 6200 Series) | |
| AM | Anti Microbial (630/626 only) | \$98.00 |
| WS | Florida HVHZ | \$66.00 |
| CD | Cylinder Dogging | \$76.00 |
| LD | Less Dogging | - |
| SNB | Sex Nuts & Bolts | \$26.00 |
| BS | Blade Stop Strike | \$63.00 |
| DD | Double Door Strike | |
| SHS | Tamper Proof Security Head Screws | \$54.00 |

6300/6400R Rim Electrified Options

| PART | DESCRIPTION | LIST PRICE |
|------|--|------------|
| AL | Alarmed Exit | \$415.00 |
| LM | Latch Bolt Monitoring | \$286.00 |
| MLR | Motorized Latch Retraction | \$1030.00 |
| SS | Signal Switch - Request to Exit or touch bar Monitoring | \$215.00 |
| ALHW | Alarmed Exit with Hard Wire Power and Relay | \$580.00 |
| ISMC | Industry Standard Molex Connector (order in addition to other electrified options) | \$108.00 |
| DE | Delayed Egress | \$1900.00 |

1: Electrified options not available on 24" device.

2: For the MLR Motorized Latch Retraction option: 3 ft devices, maximum cut is 3". 4 ft devices, maximum cut is 9".

3: For the Alarm option: 3 ft devices, maximum cut is 2". 4 ft devices, maximum cut is 8".

6300/6400V SERIES

Wide/Narrow Stile Surface Vertical Rod Exit Device



ASSEMBLED
IN THE USA

6300V Wide Stile/6400V Narrow Stile Panic & Fire Rated



Specifications

| | |
|---|---|
| Rail | • Extruded aluminum |
| Latch | • Top - Stainless Steel 3/4" toggle • Bottom - 5/8" Travel Drop Bolt • Less bottom rod option |
| Hand | • Device is non-handed • Trim is non-handed or field reversible |
| Dogging | • Hex key dogging standard • Cylinder dogging optional • Dogging not available for fire labeled devices |
| Minimum Stile Width | • 6300 - 3-1/2" • 6400 - 3 1/8" with 639027/639057 strike and 2 1/8" on aluminum frames with balde stop strike. |
| Door Thickness | • 1-3/4" - 2" (Consult factory for other) |
| Door Width | • 24", 36", 48" standard |
| Door Height | • Panic - Up to 10' • Fire - See fire ratings charts page 146 |
| Strike | • Cast top strike, plate bottom strike |
| Finishes | • 605 - Polished Brass, 606 - Satin Brass, 613E - Dark Bronze, 622 - Flat Black, 626 - Satin Chrome, 630 - Satin Stainless Steel, 630F - Full Stainless Steel • Optional Anti-Microbial Coating available on 626, 630 |
| Fasteners | • Includes machine screws and wood screws • SNB Optional |
| Warranty | • Ten (10) year limited warranty |
| Electrified Options | • Motorized Latch Retraction • Request to Exit/Signal Switch • Alarmed Exit • Latch Bolt Monitor • ISMC Connectors |
| Certifications: Compliances: Listings: | • Listed for UL 305 "Panic", listed for UL 10C "Fire Exit Hardware" up to 3 hours. • ANSI/BHMA A156.3 Grade 1 • Complies with ADA (Americans with Disabilities Act) and ICC/ANSI 117.1 for Accessible and Usable Buildings • FL #40297 +50/-50 psf 8080 18ga Pair • Meets requirements of the BAA as a COTS product manufactured in the United States |

6300/6400 SURFACE VERTICAL ROD EXIT DEVICE

LIST PRICE

Effective July 3, 2023

How to Order

6300/6400 SURFACE VERTICAL ROD EXIT DEVICE

| Series | For Door Width | Device Type | Rating | Finish | Options | Electrified Options |
|--|--|-----------------------|---|---|--|--|
| 63 | 00 | V | -- | 630 | -- | -- |
| 63 - Wide Stile Device 64 - Narrow Stile Device | 00 - 36" Door 10 - 48" Door 20 - 24" Door | V - SVR Device | Blank - Panic Rated F - Fire Rated | 605 - Bright Brass 606 - Satin Brass 613E - Dark Bronze 622 - Satin Black 625 - Bright Chrome 626 - Satin Chrome 630 - Satin Stainless 630F - Full Stainless | Dogging (Panic Rated Only): Blank - Hex Key Dogging CD - Cylinder Dogging LD - Less Dogging* LBR - Less Bottom Rod (SVR/CVR) LBR-FP - Less Bottom Rod with Fire Pin (SVR/CVR) WS - Windstorm Rated (Rim & SVR) EC - End Cap Cover TLA - Head Cover SNB - Sex Nuts & Bolts AM - Anti-Microbial SK - Shim Kit SHS - Security Head Screws 7 - 7' door (default) 8 - 8' door 10 - 8'-10' Door | MLR - Motorized Latch Retr. AL - Alarm Kit* SS - Signal Switch on touch bar LM - Latchbolt Monitor ISMC - Industry Standard Molex Connector ALHW - Alarm kit hard wired |

*Multiple Selections Allowed
 *Dogging options only apply to Panic Rated

6300V Surface Vertical Rod Wide Stile Exit Devices

| PART | DESCRIPTION | 630 | 613E/622/626 | 605/606/625 | 630F |
|------------|--|-----------|--------------|-------------|-----------|
| 6300V | Surface vertical rod, Listed to UL305 for Panic, hex key dogging, 3'0" door | \$1357.00 | \$1400.00 | \$1492.00 | \$1532.00 |
| 6300VLBR | Surface vertical rod, less bottom rod, Listed to UL305 for Panic, hex key dogging, 3'0" door | | | | |
| 6300VF | Surface vertical rod, Listed to UL10C for Fire, no dogging, 3'0" door | \$1519.00 | \$1562.00 | \$1654.00 | \$1694.00 |
| 6300VFLBR* | Surface vertical rod, less bottom rod, Listed to UL10C for Fire, no dogging, 3'0" door | | | | |
| 6310V | Surface vertical rod, Listed to UL305 for Panic, hex key dogging, 4'0" door | \$1403.00 | \$1446.00 | \$1538.00 | \$1578.00 |
| 6310VLBR | Surface vertical rod, less bottom rod, Listed to UL305 for Panic, hex key dogging, 4'0" door | | | | |
| 6310VF | Surface vertical rod, Listed to UL10C for Fire, no dogging, 4'0" door | \$1565.00 | \$1608.00 | \$1700.00 | \$1740.00 |
| 6310VFLBR* | Surface vertical rod, less bottom rod, Listed to UL10C for Fire, no dogging, 4'0" door | | | | |
| 6320V | Surface vertical rod, Listed to UL305 for Panic, no dogging, 2'0" door | \$1457.00 | \$1500.00 | \$1592.00 | \$1632.00 |
| 6320VLBR | Surface vertical rod, less bottom rod, Listed to UL305 for Panic, no dogging, 2'0" door | | | | |
| 6320VF | Surface vertical rod, Listed to UL10C for Fire, no dogging, 2'0" door | \$1619.00 | \$1662.00 | \$1754.00 | \$1794.00 |
| 6320VFLBR* | Surface vertical rod, less bottom rod, Listed to UL10C for Fire, no dogging, 2'0" door | | | | |

For devices over 7' high, add \$25 per foot

*LBR FIRE RATED DEVICES MUST BE ORDERED IN PAIRS. One fire pin furnished per pair.



6300/6400 SURFACE VERTICAL ROD EXIT DEVICE

LIST PRICE

Effective July 3, 2023

6400V Surface Vertical Rod Narrow Stile Exit Devices

| PART | DESCRIPTION | 630 | 613E/622/626 | 605/606/625 | 630F |
|------------|--|-----------|--------------|-------------|-----------|
| 6400V | Surface vertical rod, Listed to UL305 for Panic, hex key dogging, 3'0" door | \$1439.00 | \$1482.00 | \$1574.00 | \$1614.00 |
| 6400VLBR | Surface vertical rod, less bottom rod, Listed to UL305 for Panic, hex key dogging, 3'0" door | | | | |
| 6400VF | Surface vertical rod, Listed to UL10C for Fire, no dogging, 3'0" door | \$1601.00 | \$1644.00 | \$1736.00 | \$1776.00 |
| 6400VFLBR* | Surface vertical rod, less bottom rod, Listed to UL10C for Fire, no dogging, 3'0" door | | | | |
| 6410V | Surface vertical rod, Listed to UL305 for Panic, hex key dogging, 4'0" door | \$1485.00 | \$1528.00 | \$1620.00 | \$1660.00 |
| 6410VLBR | Surface vertical rod, less bottom rod, Listed to UL305 for Panic, hex key dogging, 4'0" door | | | | |
| 6410VF | Surface vertical rod, Listed to UL10C for Fire, no dogging, 4'0" door | \$1647.00 | \$1690.00 | \$1782.00 | \$1822.00 |
| 6410VFLBR* | Surface vertical rod, less bottom rod, Listed to UL10C for Fire, no dogging, 4'0" door | | | | |
| 6420V | Surface vertical rod, Listed to UL305 for Panic, no dogging, 2'0" door | \$1539.00 | \$1582.00 | \$1674.00 | \$1714.00 |
| 6420VLBR | Surface vertical rod, less bottom rod, Listed to UL305 for Panic, no dogging, 2'0" door | | | | |
| 6420VF | Surface vertical rod, Listed to UL10C for Fire, no dogging, 2'0" door | \$1701.00 | \$1744.00 | \$1836.00 | \$1876.00 |
| 6420VFLBR* | Surface vertical rod, less bottom rod, Listed to UL10C for Fire, no dogging, 2'0" door | | | | |

For devices over 7' high, add \$25 per foot

***LBR FIRE RATED DEVICES MUST BE ORDERED IN PAIRS.** One fire pin furnished per pair.

6300/6400
 SURFACE VERTICAL ROD
 EXIT DEVICE

6300/6400 SURFACE VERTICAL ROD EXIT DEVICE

LIST PRICE

Effective July 3, 2023

6300/6400V Surface Vertical Rod Mechanical Options

| PART | DESCRIPTION | EXIT DEVICE ADJUSTMENT |
|--------|---|------------------------|
| EC | End Cap Cover | \$26.00 |
| TLA | Head Cover (Similar to 6200 Series) | |
| AM | Anti Microbial (630/626 only) | \$98.00 |
| CD | Cylinder Dogging | \$76.00 |
| LD | Less Dogging | - |
| SNB | Sex Nuts & Bolts | \$26.00 |
| SHS | Tamper Proof Security Head Screws | \$54.00 |
| LBR | Less Bottom Rod | - |
| LBR-FP | Less Bottom Rod with Fire Pin (used with fire rated pair) | - |

6300/6400V Surface Vertical Rod Electrified Options

| PART | DESCRIPTION | LIST PRICE |
|------|--|------------|
| AL | Alarmed Exit | \$415.00 |
| LM | Latch Bolt Monitoring | \$286.00 |
| MLR | Motorized Latch Retraction | \$1030.00 |
| SS | Signal Switch - Request to Exit and Monitoring | \$215.00 |
| ALHW | Alarmed Exit with Hard Wire Power and Relay | \$580.00 |
| ISMC | Industry Standard Molex Connector (order in addition to other electrified options) | \$108.00 |

1: Electrified options not available on 24" device.

2: For the MLR Motorized Latch Retraction option: 3 ft devices, maximum cut is 3". 4 ft devices, maximum cut is 9".

3: For the Alarm option: 3 ft devices, maximum cut is 2". 4 ft devices, maximum cut is 8".

6300/6400C SERIES

Wide/Narrow Stile Concealed Vertical Rod Exit Device



ASSEMBLED
IN THE USA

6300C Wide Stile/6400C Narrow Stile Panic & Fire Rated



Specifications

| | |
|---|--|
| Rail | • Extruded aluminum |
| Latch | • Top - Stainless Steel 3/4" toggle • Bottom - 5/8" Travel Drop Bolt • Less bottom rod option |
| Hand | • Device is non-handed • Trim is non-handed or field reversible |
| Dogging | • Hex key dogging standard • Cylinder dogging optional • Dogging not available for fire labeled devices |
| Minimum Stile Width | • 6300 - 3-1/2" • 6400 - 3 1/8" with 639027/639057 strike and 2 1/8" on aluminum frames with balde stop strike. |
| Door Thickness | • 1-3/4" - 2" (Consult factory for other) |
| Door Width | • 24", 36", 48" standard |
| Door Height | • Panic - Up to 10' • Fire - See fire ratings charts page 146 |
| Strike | • Cast top strike, plated bottom strike |
| Finishes | • 605 - Polished Brass, 606 - Satin Brass, 613E - Dark Bronze, 622 - Flat Black, 626 - Satin Chrome, 630 - Satin Stainless Steel, 630F - Full Stainless Steel • Optional Anti-Microbial Coating available on 626, 630 |
| Fasteners | • Includes machine and wood screws • SNB Optional |
| Warranty | • Ten (10) year limited warranty |
| Electrified Options | • Motorized Latch Retraction • Request to Exit/Signal Switch • Alarmed Exit • Latch Bolt Monitor • ISMC Connectors • Delayed Egress |
| Certifications: Compliances: Listings: | • Listed for UL 305 "Panic", listed for UL 10C "Fire Exit Hardware" up to 3 hours. • ANSI/BHMA A156.3 Grade 1 Pending • Complies with ADA (Americans with Disabilities Act) and ICC/ANSI 117.1 for Accessible and Usable Buildings • Meets requirements of the BAA as a COTS product manufactured in the United States • Certified to ANSI/BHMA A156.3 Grade 1 |

6300/6400 CONCEALED VERTICAL ROD EXIT DEVICE LIST PRICE

Effective July 3, 2023

How to Order

| Series | For Door Width | Device Type | Rating | Finish | Options | Electrified Options |
|--|--|---|---|---|--|---|
| 63 | 00 | C | -- | 630 | -- | -- |
| 63 - Wide Stile Device 64 - Narrow Stile Device | 00 - 36" Door 10 - 48" Door 20 - 24" Door | C - CVR Device CWD - Wood Door | Blank - Panic Rated F - Fire Rated | 605 – Bright Brass 606 – Satin Brass 613E – Dark Bronze 622 – Satin Black 625 – Bright Chrome 626 – Satin Chrome 630 – Satin Stainless 630F – Full Stainless | Dogging (Panic Rated Only): Blank - Hex Key Dogging CD - Cylinder Dogging LD - Less Dogging* DE - Delayed Egress LBR - Less Bottom Rod (SVR/CVR) LBR-FP - Less Bottom Rod with Fire Pin (SVR/CVR) EC - End Cap Cover TLA - Head Cover SNB - Sex Nuts & Bolts AM - Anti-Microbial 7 - 7' door (default) 8 - 8' door 10 - 8'-10' Door | MLR - Motorized Latch Retr. AL - Alarm Kit* SS - Signal Switch on touch bar LM - Latchbolt Monitor ISM - Industry Standard Molex Connector DE - Delayed Egress |

*Multiple Selections Allowed
 *Dogging options only apply to Panic Rated

6300C Concealed Vertical Rod Wide Stile Exit Devices

| PART | DESCRIPTION | 630 | 613E/622/626 | 605/606/625 | 630F |
|------------|--|-----------|--------------|-------------|-----------|
| 6300C | Concealed vertical rod, Listed to UL305 for Panic, hex key dogging, 3'0" door | \$1570.00 | \$1613.00 | \$1705.00 | \$1745.00 |
| 6300CLBR | Concealed vertical rod, less bottom rod, Listed to UL305 for Panic, hex key dogging, 3'0" door | | | | |
| 6300CF | Concealed vertical rod, Listed to UL10C for Fire, no dogging, 3'0" door | \$1732.00 | \$1775.00 | \$1867.00 | \$1907.00 |
| 6300CFLBR* | Concealed vertical rod, less bottom rod, Listed to UL10C for Fire, no dogging, 3'0" door | | | | |
| 6310C | Concealed vertical rod, Listed to UL305 for Panic, hex key dogging, 4'0" door | \$1616.00 | \$1659.00 | \$1751.00 | \$1791.00 |
| 6310CLBR | Concealed vertical rod, less bottom rod, Listed to UL305 for Panic, hex key dogging, 4'0" door | | | | |
| 6310CF | Concealed vertical rod, Listed to UL10C for Fire, no dogging, 4'0" door | \$1778.00 | \$1821.00 | \$1913.00 | \$1953.00 |
| 6310CFLBR* | Concealed vertical rod, less bottom rod, Listed to UL10C for Fire, no dogging, 4'0" door | | | | |
| 6320C | Concealed vertical rod, Listed to UL305 for Panic, no dogging, 2'0" door | \$1670.00 | \$1713.00 | \$1805.00 | \$1845.00 |
| 6320CLBR | Concealed vertical rod, less bottom rod, Listed to UL305 for Panic, no dogging, 2'0" door | | | | |
| 6320CF | Concealed vertical rod, Listed to UL10C for Fire, no dogging, 2'0" door | \$1832.00 | \$1875.00 | \$1967.00 | \$2007.00 |
| 6320CFLBR* | Concealed vertical rod, less bottom rod, Listed to UL10C for Fire, no dogging, 2'0" door | | | | |

For devices over 7' high, add \$25 per foot

*LBR FIRE RATED DEVICES MUST BE ORDERED IN PAIRS. One fire pin furnished per pair.

6300/6400 CONCEALED VERTICAL ROD EXIT DEVICE

6300/6400 CONCEALED VERTICAL ROD EXIT DEVICE LIST PRICE

Effective July 3, 2023

6400C Concealed Vertical Rod Narrow Stile Exit Devices

| PART | DESCRIPTION | 630 | 613E/622/626 | 605/606/625 | 630F |
|------------|--|-----------|--------------|-------------|-----------|
| 6400C | Concealed vertical rod, Listed to UL305 for Panic, hex key dogging, 3'0" door | \$1651.00 | \$1694.00 | \$1786.00 | \$1826.00 |
| 6400CLBR | Concealed vertical rod, less bottom rod, Listed to UL305 for Panic, hex key dogging, 3'0" door | | | | |
| 6400CF | Concealed vertical rod, Listed to UL10C for Fire, no dogging, 3'0" door | \$1813.00 | \$1856.00 | \$1948.00 | \$1988.00 |
| 6400CFLBR* | Concealed vertical rod, less bottom rod, Listed to UL10C for Fire, no dogging, 3'0" door | | | | |
| 6410C | Concealed vertical rod, Listed to UL305 for Panic, hex key dogging, 4'0" door | \$1697.00 | \$1740.00 | \$1832.00 | \$1872.00 |
| 6410CLBR | Concealed vertical rod, less bottom rod, Listed to UL305 for Panic, hex key dogging, 4'0" door | | | | |
| 6410CF | Concealed vertical rod, Listed to UL10C for Fire, no dogging, 4'0" door | \$1859.00 | \$1902.00 | \$1994.00 | \$2034.00 |
| 6410CFLBR* | Concealed vertical rod, less bottom rod, Listed to UL10C for Fire, no dogging, 4'0" door | | | | |
| 6420C | Concealed vertical rod, Listed to UL305 for Panic, no dogging, 2'0" door | \$1751.00 | \$1794.00 | \$1886.00 | \$1926.00 |
| 6420CLBR | Concealed vertical rod, less bottom rod, Listed to UL305 for Panic, no dogging, 2'0" door | | | | |
| 6420CF | Concealed vertical rod, Listed to UL10C for Fire, no dogging, 2'0" door | \$1913.00 | \$1956.00 | \$2048.00 | \$2088.00 |
| 6420CFLBR* | Concealed vertical rod, less bottom rod, Listed to UL10C for Fire, no dogging, 2'0" door | | | | |

For devices over 7' high, add \$25 per foot

***LBR FIRE RATED DEVICES MUST BE ORDERED IN PAIRS.** One fire pin furnished per pair.

6300/6400
CONCEALED VERTICAL
ROD EXIT DEVICE

6300/6400 CONCEALED VERTICAL ROD EXIT DEVICE LIST PRICE

Effective July 3, 2023

6300/6400 CVR Mechanical Options

| PART | DESCRIPTION | EXIT DEVICE ADJUSTMENT |
|--------|---|------------------------|
| EC | End Cap Cover | \$26.00 |
| TLA | Head Cover (Similar to 6200 Series) | |
| AM | Anti Microbial (630/626 only) | \$98.00 |
| CD | Cylinder Dogging | \$76.00 |
| LD | Less Dogging | - |
| SNB | Sex Nuts & Bolts | \$26.00 |
| SHS | Tamper Proof Security Head Screws | \$54.00 |
| LBR | Less Bottom Rod | - |
| LBR-FP | Less Bottom Rod with Fire Pin (used with fire rated pair) | - |

6300/6400 CVR Electrified Options

| PART | DESCRIPTION | LIST PRICE |
|------|--|------------|
| AL | Alarmed Exit | \$415.00 |
| LM | Latch Bolt Monitoring | \$286.00 |
| MLR | Motorized Latch Retraction | \$1030.00 |
| SS | Signal Switch - Request to Exit and Monitoring | \$215.00 |
| ALHW | Alarmed Exit with Hard Wire Power and Relay | \$580.00 |
| ISMC | Industry Standard Molex Connector (order in addition to other electrified options) | \$108.00 |
| DE | Delayed Egress | \$1900.00 |

- 1: Electrified options not available on 24" device.
- 2: For the MLR Motorized Latch Retraction option: 3 ft devices, maximum cut is 3". 4 ft devices, maximum cut is 9".
- 3: For the Alarm option: 3 ft devices, maximum cut is 2". 4 ft devices, maximum cut is 8".

6300/6400
CONCEALED VERTICAL
ROD EXIT DEVICE

6300M SERIES

Mortise Exit Device



ASSEMBLED
IN THE USA

6300M Wide Stile Panic & Fire Rated



TLA Head Cover

Optional head cover
*630 Finish only



Specifications

| | |
|---|--|
| Rail | • Extruded aluminum |
| Latch | • Stainless steel dead locking with 3/4" throw |
| Hand | • Field reversible |
| Dogging | • Hex key dogging standard • Cylinder dogging optional • Dogging not available for fire labeled devices |
| Minimum Stile Width | • 5" |
| Door Thickness | • 1-3/4" - 2" (Consult factory for other) |
| Door Width | • 24", 36", 48" standard |
| Door Height | • Panic - Up to 10' • Fire - See fire ratings charts page 146 |
| Strike Options | • Default ASA (4-7/8") |
| Finishes | • 605 - Polished Brass, 606 - Satin Brass, 613E - Dark Oxidized Satin Bronze, 622 - Flat Black, 626 - Satin Chrome, 630 - Satin Stainless Steel, 630F - Full Stainless Steel • Optional Anti Microbial Coating available on 626, 630 |
| Fasteners | • Includes machine screws and wood screws • SNB Optional |
| Warranty | • Ten (10) year limited warranty |
| Electrified Options | • Motorized Latch Retraction • Request to Exit/Signal Switch • Alarmed Exit • Latch Bolt Monitor • ISMC Connectors • Delayed Egress |
| Certifications: Compliances: Listings: | • Listed for UL 305 "Panic", listed for UL 10C "Fire Exit Hardware" up to 90 minutes. • Complies with ADA (Americans with Disabilities Act) and ICC/ANSI 117.1 for Accessible and Usable Buildings • Meets requirements of the BAA as a COTS product manufactured in the United States |

6300 MORTISE EXIT DEVICE

LIST PRICE

Effective July 3, 2023

How to Order

| Series | For Door Width | Device Type | Rating | Finish | Options | Electrified Options |
|-------------------------------|--|---------------------------------------|----------------------------|---|---|--|
| 63 | 00 | M | -- | 630 | -- | -- |
| 63 - Wide Stile Device | 00 - 36" Door 10 - 48" Door 20 - 24" Door | M - Wide Stile Mortise Device* | Blank - Panic Rated | 605 – Bright Brass 606 – Satin Brass 613E – Dark Bronze 622 – Satin Black 625 – Bright Chrome 626 – Satin Chrome 630 – Satin Stainless 630F – Full Stainless | Dogging (Panic Rated Only): Blank - Hex Key Dogging CD - Cylinder Dogging LD - Less Dogging* DE - Delayed Egress EC - End Cap Cover TLA - Head Cover SNB - Sex Nuts & Bolts AM - Anti-Microbial SHS - Security Head Screws | MLR - Motorized Latch Retr. AL - Alarm Kit* SS - Signal Switch on touch bar LM - Latchbolt Monitor ISMC - Industry Standard Molex Connector ALHW - Alarm kit hard wired DE - Delayed Egress |

*Mortise in wide stile device only

*Multiple Selections Allowed
*Dogging options only apply to Panic Rated

*MLR can be combined with LM & SS
*AL can be combined with LM
*MLR and AL cannot be combined
*ISMC available on all
*AL - specify handing

6300M Mortise Wide Stile Exit Devices

| PART | DESCRIPTION | 630 | 613E/622/626 | 605/606/625 | 630F |
|--------|--|-----------|--------------|-------------|-----------|
| 6300M | Mortise wide stile exit, Listed to UL305 for Panic, hex key dogging, 3'0" door width | \$1510.00 | \$1553.00 | \$1645.00 | \$1685.00 |
| 6300MF | Mortise wide stile exit, Listed to UL10C for Fire, 3'0" door width | \$1672.00 | \$1715.00 | \$1807.00 | \$1847.00 |
| 6310M | Mortise wide stile exit, Listed to UL305 for Panic, hex key dogging, 4'0" door width | \$1556.00 | \$1599.00 | \$1691.00 | \$1731.00 |
| 6310MF | Mortise wide stile exit, Listed to UL10C for Fire, 4'0" door width | \$1718.00 | \$1761.00 | \$1853.00 | \$1893.00 |
| 6320M | Mortise wide stile exit, Listed to UL305 for Panic, no dogging, 2'0" door | \$1610.00 | \$1653.00 | \$1745.00 | \$1785.00 |
| 6320MF | Mortise wide stile exit, Listed to UL10C for Fire, no dogging 2'0" door | \$1772.00 | \$1815.00 | \$1907.00 | \$1947.00 |

6300 MORTISE EXIT DEVICE

6300 MORTISE EXIT DEVICE

LIST PRICE

Effective July 3, 2023

6300M Mortise Wide Stile Mechanical Options

| PART | DESCRIPTION | EXIT DEVICE ADJUSTMENT |
|------|-------------------------------------|------------------------|
| EC | End Cap Cover | \$26.00 |
| TLA | Head Cover (Similar to 6200 Series) | |
| AM | Anti Microbial (630/626 only) | \$98.00 |
| CD | Cylinder Dogging | \$76.00 |
| LD | Less Dogging | - |
| SNB | Sex Nuts & Bolts | \$26.00 |
| SHS | Tamper Proof Security Head Screws | \$54.00 |

6300M Mortise Wide Stile Electrified Options

| PART | DESCRIPTION | LIST PRICE |
|------|--|------------|
| AL | Alarmed Exit | \$415.00 |
| LM | Latch Bolt Monitoring | \$286.00 |
| MLR | Motorized Latch Retraction | \$1030.00 |
| SS | Signal Switch - Request to Exit and Monitoring | \$215.00 |
| ALHW | Alarmed Exit with Hard Wire Power and Relay | \$580.00 |
| ISMC | Industry Standard Molex Connector (order in addition to other electrified options) | \$108.00 |
| DE | Delayed Egress | \$1900.00 |

1: Electrified options not available on 24" device.

2: For the MLR Motorized Latch Retraction option: 3 ft devices, maximum cut is 3". 4 ft devices, maximum cut is 9".

3: For the Alarm option: 3 ft devices, maximum cut is 2". 4 ft devices, maximum cut is 8".

6300
MORTISE EXIT DEVICE

6300D SERIES

Dummy Exit Device



ASSEMBLED
IN THE USA

6300D Dummy



6300D



ADA COMPLIANT



Specifications

| | |
|---|---|
| Rail | • Extruded aluminum |
| Hand | • Device is non-handed |
| Dogging | • Dogging standard • Active push bar, dog to make inactive |
| Minimum Stile Width | • 3" |
| Door Thickness | • 1-3/4" - 2" (Consult factory for other) |
| Door Width | • 24", 36", 48" standard |
| Finishes | • 605 - Polished Brass, 606 - Satin Brass, 613E - Dark Bronze, 622 - Flat Black, 626 - Satin Chrome, 630 - Satin Stainless Steel, 630F - Full Stainless Steel • Optional Anti Microbial Coating available on 626, 630 |
| Fasteners | • Includes machine and wood screws • SNB Optional |
| Warranty | • Ten (10) year limited warranty |
| Electrified Options | • Request to Exit/Signal Switch • ISMC Connectors |
| Certifications: Compliances: Listings: | • Complies with ADA (Americans with Disabilities Act) and ICC/ANSI 117.1 for Accessible and Usable Buildings • Meets requirements of the BAA as a COTS product manufactured in the United States |

6300 DUMMY EXIT DEVICE

LIST PRICE
Effective July 3, 2023

How to Order

| Series | For Door Width | Device Type | Finish | Options |
|-------------------------------|--|-------------------------|---|--|
| 63 | 00 | D | 630 | -- |
| 63 - Wide Stile Device | 00 - 36" Door 10 - 48" Door 20 - 24" Door | D - Dummy Device | 605 - Bright Brass 606 - Satin Brass 613E - Dark Bronze 622 - Satin Black 625 - Bright Chrome 626 - Satin Chrome 630 - Satin Stainless 630F - Full Stainless | Dogging SS - Signal switch on touch bar |

6300D Dummy Exit Devices

| PART | DESCRIPTION | 630 | 613E/622/626 | 605/606/625 | 630F |
|-------|------------------|-----------|--------------|-------------|-----------|
| 6300D | Dummy, 3'0" door | \$902.00 | \$945.00 | \$1037.00 | \$1077.00 |
| 6310D | Dummy, 4'0" door | \$948.00 | \$991.00 | \$1083.00 | \$1123.00 |
| 6320D | Dummy, 2'0" door | \$1002.00 | \$1045.00 | \$1137.00 | \$1177.00 |

6300
MORTISE EXIT DEVICE

6300D Dummy Mechanical Options

| PART | DESCRIPTION | EXIT DEVICE ADJUSTMENT |
|------|-----------------------------------|------------------------|
| EC | End Cap Cover | \$26.00 |
| SNB | Sex Nuts & Bolts | |
| SHS | Tamper Proof Security Head Screws | \$54.00 |

6300D Dummy Electrified Options

| PART | DESCRIPTION | EXIT DEVICE ADJUSTMENT |
|------|--|------------------------|
| SS | Signal Switch - Request to Exit and Monitoring | \$215.00 |

6300RF / 6400RF Rim Devices

| | | RATING | MAX OPENING | APPLICATION |
|---|--------------------------------|--------------|---------------|--|
|  | Single Door | 3 Hour Rated | 4' x 10' Door | |
|  | Double Door with 9300F Mullion | 3 Hour Rated | 8' x 8' Pair | Single Egress Pairs (Swing Same Direction) |

6300VF / 6400VF Surface Vertical Devices

| | | RATING | MAX OPENING | APPLICATION |
|--|--|--------------|---|---|
|  | Double Door Top/Btm Latches or Less Bottom Rod (LBR) | 3 Hour Rated | 8' x 10' Top/Btm Latches 8' x 8' Less Bottom Rod | Single Egress Pairs (Swing Same Direction) |
|  | Double Door Top/Btm Latches or Less Bottom Rod (LBR) | 3 Hour Rated | 8' x 10' Top/Btm Latches 8' x 8' Less Bottom Rod | Double Egress Pairs (Swing Opposite Directions) |

6300CF / 6400CF Concealed Vertical Devices

| | | RATING | MAX OPENING | APPLICATION |
|---|--|--------------|--------------|---|
|  | Double Door Top/Btm Latches or Less Bottom Rod (LBR) | 3 Hour Rated | 8' x 8' Pair | Single Egress Pairs (Swing Same Direction) |
|  | Double Door Top/Btm Latches or Less Bottom Rod (LBR) | 3 Hour Rated | 8' x 8' Pair | Double Egress Pairs (Swing Opposite Directions) |

6300MF Mortise Devices

| | | RATING | MAX OPENING | APPLICATION |
|---|-------------|-----------------|--------------|-------------|
|  | Single Door | 90 Minute Rated | 4' x 8' Door | |

6300/6400 DIMENSIONS

LIST PRICE

Effective July 3, 2023

6300 Series Wide Stile

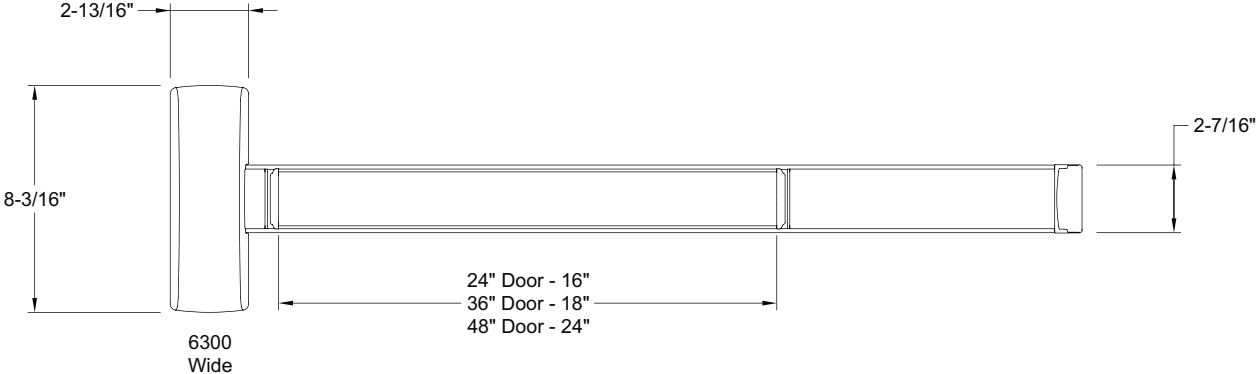

6400 Series Narrow Stile

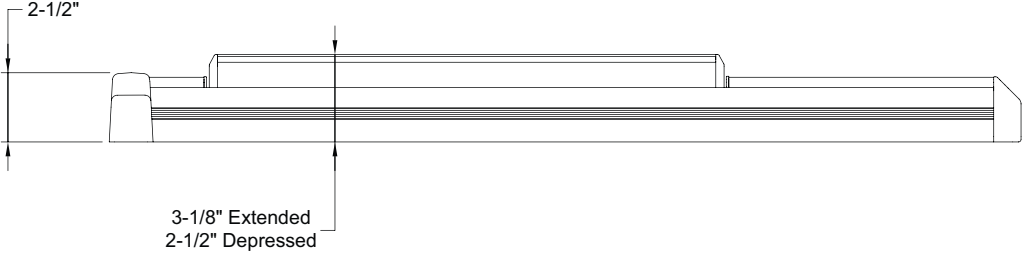
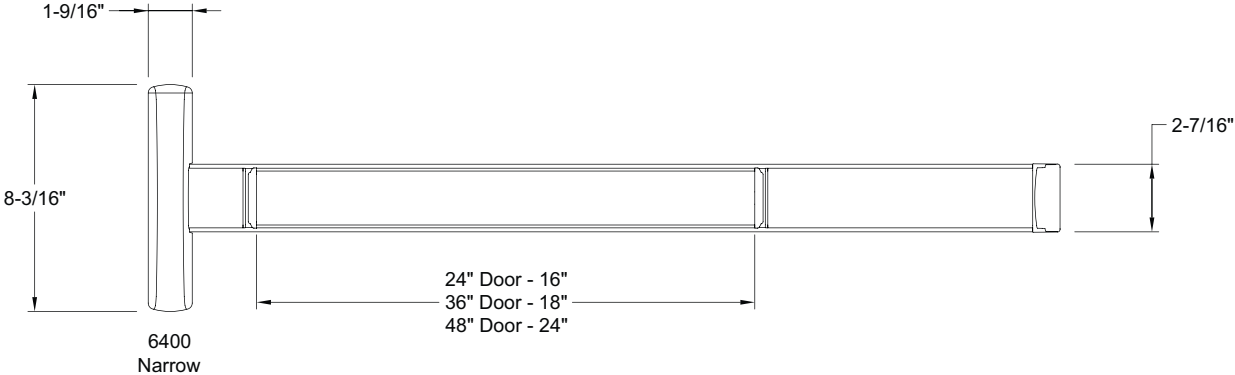

6300/6400 SERIES

LIST PRICE

Effective July 3, 2023

6300/6400 Series Door Width Chart

| PART | DESCRIPTION | FOR DOOR | MAX CUT ^{1,2} |
|----------|---------------------------|----------|------------------------|
| 6300R-CD | 6300 Rim Cylinder dogging | 36" | 6" |
| 6300R | 6300 Rim Hex Key dogging | 36" | 6" |
| 6300RF | 6300 Rim Fire | 36" | 8" |
| 6300V-CD | 6300 SVR Cylinder dogging | 36" | 6" |
| 6300V | 6300 SVR Hex Key dogging | 36" | 6" |
| 6300VF | 6300 SVR Fire | 36" | 8" |
| 6300C | 6300 CVR Hex Key dogging | 36" | 6" |
| 6300CF | 6300 CVR Fire | 36" | 8" |
| 6310R-CD | 6300 Rim Cylinder dogging | 48" | 12" |
| 6310R | 6300 Rim Hex Key dogging | 48" | 12" |
| 6310RF | 6300 Rim Fire | 48" | 14" |
| 6310V-CD | 6300 SVR Cylinder dogging | 48" | 12" |
| 6310V | 6300 SVR Hex Key dogging | 48" | 12" |
| 6310VF | 6300 SVR Fire | 48" | 14" |

| 24" DEVICE |
|---------------------|
| No cut |
| No electric options |

1: For the MLR Motorized Latch Retraction option: 3 ft devices, maximum cut is 3". 4 ft devices, maximum cut is 9".

2: For the Alarm option: 3 ft devices, maximum cut is 2". 4 ft devices, maximum cut is 8".

6300 Wide Stile Cross Reference

| MANUFACTURER | EXIT DEVICE SERIES/TYPE | | | | | | | |
|--------------|-------------------------|---------------|--------------|-------------------|------------------------|-----------------------------|--------------|---------------|
| | RIM | RIM FIRE | VERTICAL ROD | VERTICAL ROD FIRE | CONCEALED VERTICAL ROD | CONCEALED VERTICAL ROD FIRE | MORTISE | MORTISE FIRE |
| PDQ | 6300R | 6300RF | 6300V | 6300VF | 6300C | 6300CF | 6300M | 6300MF |
| CORBIN | ED5200 | ED5200A | ED5400 | ED5400A | ED5860 | ED5860B | ED5600 | ED5600A |
| DORMA | 9300 | F9300 | 9400 | F9400 | 9100 | F9100 | 9500 | F9500 |
| FALCON | 25-R | F-25-R | 25-V | F-25-V | 25-C | F-25-C | 25-M | F-25-M |
| HAGER | 4501 RIM | 4501 RIM FR | 4501 SVR | 4501 SVR FR | 4500 CVR | 4500 CVR FR | 4500 MOR | 4500 MOR FR |
| SARGENT® | 8800 | 12-8800 | 8700 | 12-8700 | 8600 | 12-8600 | 8900 | 12-8900 |
| VON DUPRIN | 98/99 | 98/99-F | 98/9927 | 98/9927-F | 98/9947 | 98/9947-F | 98/9975 | 98/9975-F |
| YALE | 7100 | 7100F | 7110 | 7110F | 7160 | 7160F | 7130 | 7130F |

6400 Narrow Stile Cross Reference

| MANUFACTURER | EXIT DEVICE SERIES/TYPE | | | | | |
|--------------|-------------------------|---------------|--------------|-------------------|------------------------|-----------------------------|
| | RIM | RIM FIRE | VERTICAL ROD | VERTICAL ROD FIRE | CONCEALED VERTICAL ROD | CONCEALED VERTICAL ROD FIRE |
| PDQ | 6400R | 6400RF | 6400V | 6400VF | 6400C | 6400CF |
| CORBIN | ED4200 | ED4200MA | ED4400 | ED4400MA | ED4800 | ED4800MA |
| DORMA | 9700 | F9700 | 9800 | F9800 | 9600 | F9600 |
| FALCON | 24-R | F-24-R | 24-V | F-24-V | 24-C | F-24-C |
| HAGER | 4601 RIM | 4601 RIM FR | 4601 SVR | 4601 SVR FR | 4601 CVR | 4601 CVR FR |
| SARGENT® | 8500 | 12-8500 | N/A | N/A | 8400 | 12-8400 |
| VON DUPRIN | 33A/35A | 33A/35A-F | 3327A/3527A | 3327A/3527A-F | 3347A/3547A | 3347A/3547A-F |
| YALE | 7200 | 7200F | 7210 | 7210F | 7220 | 7220F |

The following options are available when ordering 6300/6400 devices.

LBR

Less Bottom Rod is available on SVR and CVR devices. This option deletes the bottom latch on applications where the bottom latch would impede access, or where a floor strike is not desired. LBR option is available on both panic and fire rated devices.

EC

End Cap Cover option provides a cover for the standard end cap. Can be used if the look is preferred, or to cover the end of the rail on devices that have been cut down.

TLA

The TLA head cover can be ordered to make the 6300 device better match the previous generation 6200 devices. The head cover is available in 630 finish only.

SNB

Order the SNB option if Sex Nuts are required. These are used on devices when trim is not used, and door construction is not sufficient to hold screws (such as wood or composite core).

SK

The Shim Kit is used to space the device out from the door. Shims are available in 1/8" and 1/4" thickness. Use multiple shims for additional clearance.



The following Rim Strike options are available when ordering 6300/6400 devices.

BS – Blade Stop Strike (631041) – Rim Device

This strike is used on aluminum store front doors with a 1 / 2" blade stop. Strike comes with a protective plate to latch rubbing on frame and required mounting hardware.

Strike is optional on both 6300 and 6400 devices.



ML – Mullion Fire Strike (639080) – Rim Device

This strike must be used for fire labeled rim devices when used with the 9300F mullion. It is also used for windstorm HVHZ labeled devices.

(2) ML strikes are included with every fire rated mullion.

DD – Double Door Strike (631035) – Rim Device

This strike is used to mount a rim device on a pair of doors where one door is fixed by another means (e.g. Flush bolts, Surface bolts)



Rim Device Stile Width Chart

| Order Option | Strike # | Application | 6300 Min Stile | 6400 Min Stile |
|---------------|----------|--------------------------|----------------|----------------|
| Default Panic | 639027 | Standard Panic Labeled | 4-1/4" | 3-1/8" |
| Default Fire | 639057 | Standard Fire Labeled | 4-1/4" | 3-1/8" |
| Default Panic | 639027 | Panic Labeled Mullion | 4-3/4" | 3-5/8" |
| ML | 639080 | Fire Labeled Mullion | 4-7/8" | 3-3/4" |
| WS | 639080 | Windstorm | 4-3/8" | 3-1/4" |
| DD | 631035 | Double Door Strike | 4-1/4" | 3-1/8" |
| BS | 631041 | Panic Labeled Blade Stop | 3-1/2" | 2-1/8" |

6300/6400 SERIES PARTS

LIST PRICE

Effective July 3, 2023

Parts

| Panic Rated Head Chassis (for replacement only) | Specify | | Price Each |
|---|-------------|--------------|------------|
| | Wide Stile | Narrow Stile | |
| Rim | 639001-R | 649001-R | \$250.00 |
| Vertical Rod | 639001-V | 649001-V | \$330.00 |
| Concealed Vertical Rod | 639001-C | 649001-C | |
| Mortise | 639001-M | - | |
| Mortise Lock Body | J163-finish | - | \$275.00 |

| Fire Rated Head Chassis (for replacement only) | Specify | | Price Each |
|--|-------------|--------------|------------|
| | Wide Stile | Narrow Stile | |
| Rim | 639001-RF | 649001-RF | \$250.00 |
| Vertical Rod | 639001-V | 649001-V | \$330.00 |
| Concealed Vertical Rod | 639001-V | 649001-V | |
| Mortise | 639001-M | - | |
| Mortise Lock Body | J163-finish | - | \$275.00 |

| Latch Bolt Assembly *Does not include latchbolt cover | Specify | Price Each |
|---|---------|------------|
| Surface or Concealed Vertical Rod Top Latchbolt | 639029 | \$80.00 |
| Surface or Concealed Vertical Rod Bottom Latchbolt | 639030 | \$120.00 |
| Surface Vertical Rod Latchbolt mounting Bracket | 631513 | \$16.00 |
| Concealed Vertical Rod Steel/Wood Door Latch Mounting Bracket | 631511 | |
| Less Bottom Rod Fire Bolt Kit | 639720 | \$170.00 |

| Vertical Rod Parts | Specify | Price Each |
|---|-------------------|------------|
| Surface Vertical Rod Bottom Rod | 631212SVRB-XXX* | \$55.00 |
| Surface Vertical Rod Top Rod - 7' opening | 631212SVRT-XXX* | |
| Surface Vertical Rod Top Rod- 8' opening | 6312128SVR-XXX* | \$60.00 |
| Surface Vertical Rod 3' Top Rod Extension | 631212-36EXT-XXX* | \$55.00 |
| Concealed Vertical Rod Bottom Rod | 631212CVRB | |
| Concealed Vertical Rod Top Rod 7' opening | 631212CVRT | |
| Concealed Vertical Rod Top Rod 8' opening | 6312128CVR | \$60.00 |
| Vertical Rod Connector | 631205 | \$28.00 |
| Vertical Rod Extension Coupler | 631206 | |
| Concealed Vertical Rod End Link Assembly | 639060 | \$60.00 |

*Specify finish



Parts

| Push Bar (specify finish) | Specify | | Price Each |
|---------------------------|----------------|----------------|------------|
| | 3' | 4' | |
| Device push bar | 639703-36-XXX* | 639703-48-XXX* | \$250.00 |
| Push Bar faceplate | 631030-18-XXX* | 631030-24-XXX* | \$100.00 |

*Specify finish

Covers/Caps

Covers and Cap fasteners are listed separately

| Standard Head/Chassis Cover (specify finish) | Specify | | Price Each |
|--|-----------------------|---------------|------------|
| | Wide Stile | Narrow Stile | |
| Rim | 639704RW-XXX* | 639704RN-XXX* | \$120.00 |
| Vertical Rod | 639704VW-XXX* | 639704VN-XXX* | |
| Concealed Vertical Rod | 639704BW-XXX* | 639704BN-XXX* | |
| Mortise | 639704BW-XXX* | - | |
| TLA Head/Chassis Cover | Specify | | Price Each |
| | Wide Stile | Narrow Stile | |
| Rim | 639705RW-630 | 639705RN-630 | \$120.00 |
| Vertical Rod | 639705VW-630 | 639705VN-630 | |
| Concealed Vertical Rod | 639705BW-630 | 639705BN-630 | |
| Mortise | 639705BW-630 | - | |
| SVR Latch Cover (specify finish) | Specify | | Price Each |
| | Wide and Narrow Stile | | |
| Latch cover for surface vertical rod top or bottom | 631706-XXX | | \$55.00 |
| End Caps (specify finish) See fasteners section for screwpack | Specify | | Price Each |
| | Wide and Narrow Stile | | |
| End Cap | 631032-XXX* | | \$50.00 |
| End Cap Cover | 631707-XXX* | | \$32.00 |
| Miscellaneous | Specify | | Price Each |
| | Wide and Narrow Stile | | |
| SVR Rod Guide Assembly (sold with fastener) | 639708-XXX* | | \$40.00 |
| Filler Plate Plastic End Cap | 631034 | | \$5.00 |
| Cover Bottom Plug for Surface Vertical LBR application | 631222 | | |

*Specify finish

Strikes & Shim's

| Rim Strikes | Specify | Price Each |
|--|---------|------------|
| Rim Panic Strike | 639709 | \$35.00 |
| Rim Fire Strike | 639710 | |
| Rim Blade Stop Strike | 639711 | \$110.00 |
| Rim Mullion Fire / Windstorm Strike | 639712 | \$135.00 |
| Rim Double Door Strike | 639714 | \$82.00 |
| Rim Strike Shim's | Specify | Price Each |
| Rim Panic Strike Shim .100" | 631126 | \$14.00 |
| Rim Fire Strike Shim .100" | | |
| Rim Blade Stop Strike Shim .100" | | |
| Rim Mullion Fire / Windstorm Strike Shim .100" | 631619 | \$32.00 |
| Vertical Rod Strikes | Specify | Price Each |
| Surface & Concealed Vertical Rod Top Strike | 639715 | \$35.00 |
| Surface & Concealed Vertical Rod Bottom Strike | 639716 | |
| Vertical Rod Strike Shim's | Specify | Price Each |
| Top Strike Shim 1/16" | 631541 | \$14.00 |
| Mortise Exit Strikes | Specify | Price Each |
| Non Handed 6300M strike | 631416 | \$55.00 |

| Device Shim Kits 1/8" Thickness | Specify | | Price Each |
|------------------------------------|------------|--------------|------------|
| | Wide Stile | Narrow Stile | |
| Rim | 631125-830 | 631125-840 | \$135.00 |
| Surface Vertical Rod | 631125-832 | 631125-842 | |
| Concealed Vertical Rod | 631125-830 | 631125-840 | |
| Mortise | 631125-820 | - | |
| 1/4" Thickness | Specify | | Price Each |
| | Wide Stile | Narrow Stile | |
| Rim | 631125-430 | 631125-440 | \$165.00 |
| Surface Vertical Rod | 631125-432 | 631125-442 | |
| Concealed Vertical Rod | 631125-430 | 631125-430 | |
| Mortise | 631125-420 | - | |

Parts

| Drill Guides | Specify | Price Each |
|--|------------|------------|
| | Wide Stile | |
| Standard Roller Rim Strike Drill Guide | 631127 | \$25.00 |
| Mullion Rim Fire / Windstorm Drill Guide | 631620 | |

Conversion Kits

| Cylinder Dogging Conversion Kits (specify finish) *Cylinder and trim rings not included | Specify | | Price Each |
|--|----------------|----------------|------------|
| | Wide Stile | Narrow Stile | |
| 3' Cylinder Dogging Conversion Kit | 639701-3WC-XXX | 639701-3NC-XXX | \$120.00 |
| 4' Cylinder Dogging Conversion Kit | 639701-4WC-XXX | 639701-4NC-XXX | |
| Collars for Cylinder Dogging (specify finish) | Specify | | Price Each |
| | Wide Stile | Narrow Stile | |
| Tall Trim Ring / Spacer Reversible 5/8 Collar or 3/4" Spacer | 631094-XXX | - | \$30.00 |
| Short Trim Ring / Spacer Reversible No Height Collar or 1/4" Spacer | 631093-XXX | - | \$18.00 |

| Alarm Conversion Kits (specify finish) *Cylinder and trim rings not included | Specify | | Price Each |
|---|-----------------|-----------------|------------|
| | Wide Stile | Narrow Stile | |
| 3' Panic Device | 639702P-3WA-XXX | 639702P-3NA-XXX | \$415.00 |
| 4' Panic Device | 639702P-4WA-XXX | 639702P-4NA-XXX | |
| 3' Fire Device | 639702F-3WA-XXX | 639702F-3NA-XXX | |
| 4' Fire Device | 639702F-4WA-XXX | 639702F-4NA-XXX | |

Cylinder Dogging Application Chart

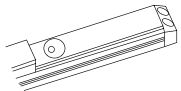
| TRIM TYPE | FUNCTION | IMAGE | STANDARD CYLINDER | BEST SFIC | SCHLAGE STYLE LFIC |
|-------------------------|-------------|---|---|---|--|
| CYLINDER DOGGING | All Devices |  | 1-1/8" Mortise Cylinder 631093 Trim Ring Yale Cam | SFIC 7 pin housing (2) 631093 Trim Rings Yale Cam | LFIC housing 631094 Collar (5/8") Yale Cam |

Parts

| Replacement Dogging Parts | Specify | Price Each |
|--|---------|------------|
| Hex Dogging Mechanism | 639022H | \$82.00 |
| Cylinder Dogging Mechanism | 639022C | |
| Cylinder anti-rotation plate (alarm kit & cyl dogging) | 631095 | \$10.00 |
| Cylinder retaining nut (alarm kit, cylinder dogging, 6N, 6W) | 88644 | |
| Dogging Key - 3/16" with Loop | 631113 | \$14.00 |
| Cylinder Nut Tool | 88875 | \$150.00 |

| Screwpacks | Specify | Price Each |
|--|-----------|------------|
| Device Screwpack | 639043 | \$16.00 |
| Surface Vertical Rod Connector Screwpack | 639044 | |
| Surface Vertical Rod Latch Screwpack | 639045 | |
| Concealed Vertical Rod Latch Screwpack | 639049 | |
| Rim Strike Screwpack | 639050 | \$6.00 |
| Vertical Rod Strike Screwpack (SVR/CVR) | 639054 | \$16.00 |
| Sex Bolt (SNB) 4 Pack 626/630 | 639053-04 | \$45.00 |
| Sex Bolt (SNB) 4 Pack 622/613E | 639053-H | |
| Sex Bolt (SNB) 4 Pack 605/606 | 639053-08 | |
| Screwpack, Head Cover or SVR Latch Cover | 639721 | \$16.00 |
| Screwpack, End Cap Cover | 639722 | |

| Electrification | Specify | Price Each |
|--|-----------------|------------|
| Signal Switch (for panic rated device) | 639718 | \$215.00 |
| Signal Switch (for fire rated device) | 639719 | |
| Motorized Latch Retraction | 639026 | \$1255.00 |
| Wire Routing Guide | 639067 | \$60.00 |
| Latchbolt monitoring | contact factory | \$285.00 |

6300/6400 SERIES

Wide Stile/Narrow Stile Exit Device Trims

Trims are non-handed and use simple door prep based on a 2 hole bolt pattern with 7" centers, or a 4 hole bolt pattern with 7"x1-3/8" centers.

Narrow escutcheons work with both wide and narrow stile devices. Wide escutcheons work only with wide stile devices.



6N Narrow Escutcheon - A narrow profile escutcheon for 6300 or 6400 device. Available in 6 lever styles, and in 6 functions. Use with narrow stile devices or a wide stile device when a slimmer look is desired.



6W Wide Escutcheon - A wide escutcheon for the 6300 device. Available in 6 lever styles, and 5 functions - including electric locking. Use with wide stile devices, when a more substantial look is desired, or for retrofit where covering existing holes is important.

**Not compatible with 6400 narrow stile devices*



6T Thumb Latch - A grip pull with a thumb latch for 6300 or 6400 devices. Available in 4 functions.

**Not compatible with 6400C narrow stile devices.*



6P Pull Plate - Stainless Steel pull plate for 6300 device.

**Not compatible with 6400 narrow stile devices.*



6G Grip Pull - A grip pull for 6300 or 6400 devices. Made of stainless steel, this grip pull is available in 2 functions.



6S Rose Trim - Rose trim that fits into standard 161 prepped door with thru bolts. Works with 6300 rim, SVR and CVR devices. Available in 3 lever styles and in 4 functions.

**Not compatible with 6400 narrow stile devices*



6C Cylinder only - Order this trim option for cylinder only, NightLatch (F03) Function. Includes rim cylinder or *IC rim housing, collar, and required mounting hardware.

**IC core sold separately*

Lever Styles

PHL



BSN



MIA



ORL



CHI



LAX



6300/6400 SERIES TRIMS

LIST PRICE

Effective July 3, 2023

How to Order

| TRIM TYPE | LEVER | FINISH | OPTIONS | CYLINDER TYPE | KEYWAY | KEYING |
|--|-----------------------------------|------------------------------|--|--|----------------------------------|--|
| 6N08 | PHL | 630 | AM | D | SCC | KD |
| Narrow Escutcheon | PHL – Philadelphia | 605 – Bright Brass | AM - Antimicrobial | D Default | SCC – Schlage C | KD – Keyed Different |
| 6N01/6NM01 – Narrow, Blank (No Lever) | BSN – Boston | 606 – Satin Brass | TC - Tactile Abrasive Coating | L Less Cylinder | OTHERS – See Keyway Table | KA – Keyed Like |
| 6N02/6NM02 – Narrow, Fixed Lever | MIA – Miami | 613E – Dark Bronze | TD4 - 2-1/2" - 2-3/4" thick application | SF6 Lock is SFIC prepped w/ 6 pin core | | KO – Zero Bitted |
| 6N03 – Narrow, Cylinder Only (No Lever) Night Latch | *CHI – Chicago | 622 – Satin Black | TD5 - Up to 3" thick application | SF7 Lock is SFIC prepped w/ 7 pin core | | MK – Master Keyed |
| 6N08/6NM08 – Narrow, Classroom | *ORL – Orlando | | | SFL Lock is SFIC prepped but less core | | CMK – Construction Master Keyed |
| 6N09/6NM09 – Narrow Storeroom | *LAX – Los Angeles | 625 – Bright Chrome | | SFC Lock is SFIC prepped w/ construction core | | GMK – Grand Master Keyed |
| 6N14/6NM14 – Narrow Passage | *Not available with S Trim | 626 – Satin Chrome | | SFP Lock is SFIC prepped w/ plastic construction core | | |
| Wide Escutcheon | | 630 – Satin Stainless | | LF6 Lock is Schlage LFIC prepped w/ Schlage core | | |
| 6W02/6WM02 – Wide, Fixed Lever | | | | LFL Lock is Schlage LFIC prepped but less core | | |
| 6W08/6WM08 – Wide, Classroom | | | | LFC Lock is Schlage LFIC prepped w/ construction core | | |
| 6W09/6WM09 – Wide, Storeroom | | | | | | |
| 6W14/6WM14 – Wide, Passage | | | | | | |
| 6W99/6WM99 – Electrified | | | | | | |
| Sectional/Rose | | | | | | |
| 6S02 – Sectional, Rigid Lever | | | | | | |
| 6S08 – Sectional, Classroom | | | | | | |
| 6S09 – Sectional, Storeroom | | | | | | |
| 6S14 – Sectional, Passage | | | | | | |
| Thumb Latch | | | | | | |
| 6T02 – Thumb Latch, Dummy, Rigid thumb piece | | | | | | |
| 6T05 – Thumb Latch, Classroom | | | | | | |
| 6T06 – Thumb Latch, Storeroom | | | | | | |
| 6T15 – Thumb Latch, Passage | | | | | | |
| Pull Plate | | | | | | |
| 6P03 – Pull Plate, Cylinder | | | | | | |
| Grip Pull | | | | | | |
| 6G02/6GM02 – Pull only | | | | | | |
| 6G03/6GM03 – Night Latch | | | | | | |
| Cylinder Only | | | | | | |
| 6C03/6CM03 – Cylinder Only | | | | | | |

6300/6400
EXIT DEVICE TRIMS



6N
Narrow Escutcheon
01, 02, 03, 08, 09, 14



6W
Wide Escutcheon
02, 08, 09, 14, 99



6G
Grip Pull
02, 03



6T
Thumb Latch
02, 05, 06, 15



6P
Pull Plate
02, 03



6S
Sectional/Rose
02, 08, 09, 14



6C
Cylinder Only
03

6300/6400 SERIES TRIMS

LIST PRICE

Effective July 3, 2023

6N Functions

01 Blank

Blank Escutcheon



02 Pull Only

Entrance/Pull only when device is dogged. Fixed lever.

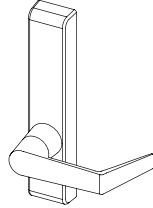

03 Night Latch

Entrance when latch retracted by key. Key removable only when locked.

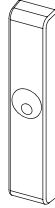

08 Classroom

Key locks or unlocks lever.

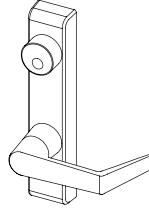

09 Storeroom

Entrance by lever when unlocked by key. Key removable only when locked.

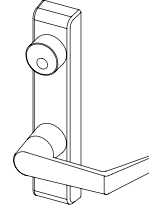

14 Passage

Entrance by lever, always unlocked.

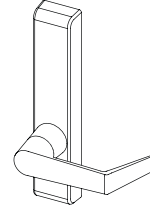

6N Lever Styles

PHL

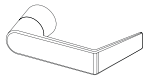

BSN



MIA

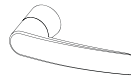

ORL

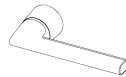

CHI

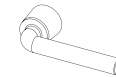

LAX

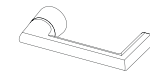

Applicable Devices

- 6400R Narrow Rim Device
- 6400V Narrow Surface Vertical Device
- 6400C Narrow Concealed Vertical Device
- 6300R Wide Stile Rim Device
- 6300V Wide Surface Vertical Device
- 6300C Wide Concealed Vertical Device
- 6300M Wide Mortise Device (Except 03 function)

| CYLINDER OPTIONS | ICON | LOCK ADJUSTMENT |
|------------------|------|-----------------|
| SFL | | N/C |
| LFL | | |
| D | | |

IC Core not included.

6N Narrow Stile Trim

| 6N | APPLICATION | FUNCTION | DESCRIPTION | LEVER | 630 | 605/606/ 613E/622/625/626 |
|----|---|----------|--------------------------|------------------------------|----------|------------------------------|
| | Rim Surface Vertical Rod Concealed Vertical Rod | 01 | Blank (no lever) | PHL, BSN, MIA, ORL, CHI, LAX | \$109.00 | \$125.00 |
| | | 02 | Dummy Trim (Rigid Lever) | | \$384.00 | \$400.00 |
| | | 03 | Night Latch (no lever) | | \$171.00 | \$187.00 |
| | | 08 | Classroom w/ Lever | | \$446.00 | \$462.00 |
| | | 09 | Storeroom w/ Lever | | \$446.00 | \$462.00 |
| | | 14 | Passage w Lever | | \$384.00 | \$400.00 |

6300/6400 SERIES TRIMS

LIST PRICE

Effective July 3, 2023

6NM Narrow Stile Mortise Trim

| 6N | APPLICATION | FUNCTION | DESCRIPTION | LEVER | 630 | 605/606/ 613E/622/625/626 |
|--|-------------|----------|--------------------------|---------------------------------|----------|------------------------------|
| NARROW ESCUTCHEON  | Mortise | M01 | Blank (no lever) | PHL, BSN, MIA, ORL, CHI, LAX | \$109.00 | \$125.00 |
| | | M02 | Dummy Trim (Rigid Lever) | | \$384.00 | \$400.00 |
| | | M08 | Classroom w/ Lever | | \$446.00 | \$462.00 |
| | | M09 | Storeroom w/ Lever | | | |
| | | M14 | Passage w Lever | | \$384.00 | \$400.00 |

6300/6400
 EXIT DEVICE TRIMS

6300/6400 SERIES TRIMS

LIST PRICE
Effective July 3, 2023

6W Functions

02 Pull Only

Entrance/Pull only when device is dogged. Fixed lever.

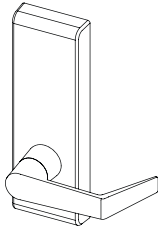

08 Classroom

Key locks or unlocks lever. Conversion kit included to convert locking function.

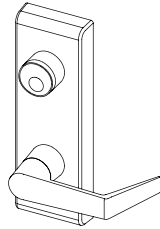

09 Storeroom

Entrance by lever when unlocked by key. Key removable only when locked.

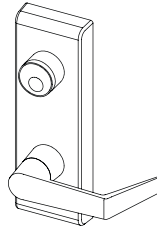

14 Passage

Entrance by lever, always unlocked.

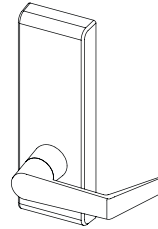

99 Electrified

Locked/Unlocked electronically. FS/FSF configurable. Entry by key. Key does not change lock state.

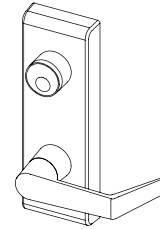

6W Lever Styles

PHL

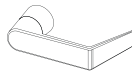

BSN



MIA

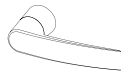

ORL

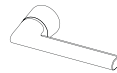

CHI



LAX

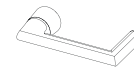

Applicable Devices

- 6300R Wide Stile Rim Device
- 6300V Wide Surface Vertical Device
- 6300C Wide Concealed Vertical Device
- 6300M Wide Mortise Device

| CYLINDER OPTIONS | ICON | LOCK ADJUSTMENT |
|------------------|------|-----------------|
| SFL | | N/C |
| LFL | | |
| D | | |

IC Core not included.

6W Wide Stile Trim

| 6W | APPLICATION | FUNCTION | DESCRIPTION | LEVER | 630 | 605/606/ 613E/622/625/626 |
|----|---|----------|--------------------------|------------------------------|----------|------------------------------|
| | Rim Surface Vertical Rod Concealed Vertical Rod | 02 | Dummy Trim (Rigid Lever) | PHL, BSN, MIA, ORL, CHI, LAX | \$415.00 | \$431.00 |
| | | 08 | Classroom w/ Lever | | \$478.00 | \$494.00 |
| | | 09 | Storeroom w/ Lever | | \$415.00 | \$431.00 |
| | | 14 | Passage w/ Lever | | \$867.00 | \$883.00 |
| | | 99 | Electrified Storeroom | | | |

6W08 and 6W09 includes conversion kit from factory (6W08 to 6W09 or 6W09 to 6W08)

6300/6400 SERIES TRIMS

LIST PRICE

Effective July 3, 2023

6WM Wide Stile Mortise Trim

| 6W | APPLICATION | FUNCTION | DESCRIPTION | LEVER | 630 | 605/606/ 613E/622/625/626 |
|---|-------------|----------|--------------------------|------------------------------|----------|------------------------------|
|  <p>WIDE STILE</p> | Mortise | M02 | Dummy Trim (Rigid Lever) | PHL, BSN, MIA, ORL, CHI, LAX | \$415.00 | \$431.00 |
| | | M08 | Classroom w/ Lever | | \$478.00 | \$494.00 |
| | | M09 | Storeroom w/ Lever | | \$415.00 | \$431.00 |
| | | M14 | Passage w/ Lever | | \$867.00 | \$883.00 |
| | | M99 | Electrified Storeroom | | | |

6W08 and 6W09 includes conversion kit from factory (6W08 to 6W09 or 6W09 to 6W08)

6T Functions

02 Pull Only

Entrance/Pull only when device is dogged. Rigid Thumb piece.

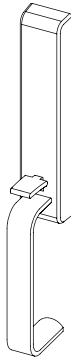

05 Classroom

Key locks or unlocks thumb piece.

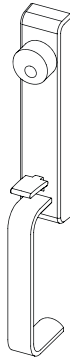

06 Storeroom

Entrance by thumb piece when released by key. Key removable only when locked.

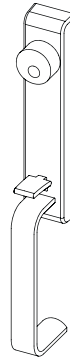

15 Passage

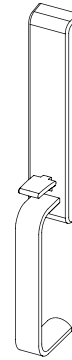

Entrance by lever when unlocked by key. Key removable only when locked.



Applicable Devices

- 6300R Wide Stile Rim Device
- 6300V Wide Surface Vertical Device
- 6300C Wide Stile Concealed Vertical Device
- 6400R Narrow Rim Device
- 6400V Narrow Surface Vertical Device
- 6400C Narrow Concealed Vertical Device

6T Thumb Latch Trim

| 6T | APPLICATION | FUNCTION | DESCRIPTION | 630 | 613E/622 | CYLINDER OPTIONS | ICON | LOCK ADJUSTMENT |
|--|---|----------|------------------------------|----------|----------|------------------|---|-----------------|
| THUMB LATCH  | Rim Surface Vertical Rod Concealed Vertical Rod | 02 | Dummy. Rigid thumb piece. | \$345.00 | \$361.00 | SFL |  | N/C |
| | | 05 | Classroom | \$370.00 | \$386.00 | LFL |  | |
| | | 06 | Storeroom | | | D |  | |
| | | 15 | Passage | \$345.00 | \$361.00 | | | |

IC Core not included.

6P Functions

03 Night Latch

Entrance when latch retracted by key. Key removable only when locked.

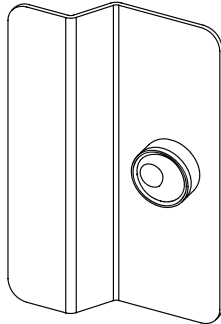

Applicable Devices

- 6300R Wide Stile Rim Device
- 6300V Wide Surface Vertical Device
- 6300C Wide Concealed Vertical Device

6P Pull Trim

| 6P | APPLICATION | FUNCTION | DESCRIPTION | 630 | 613E/622 | CYLINDER OPTIONS | ICON | LOCK ADJUSTMENT |
|--|------------------------|----------|-------------|----------|----------|------------------|---|-----------------|
| PULL TRIM  | Rim | 03 | Night Latch | \$158.00 | \$174.00 | SFL |  | N/C |
| | Surface Vertical Rod | | | | | LFL |  | |
| | Concealed Vertical Rod | | | | | D |  | |

IC Core not included.

6300/6400 SERIES TRIMS

LIST PRICE

Effective July 3, 2023

6G Functions

02 Pull Only

Entrance/Pull only when device is dogged.

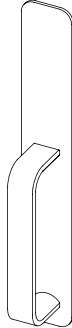

03 Night Latch

Entrance when latch retracted by key. Key removable only when locked.

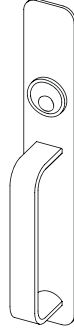

M03 Mortise Night Latch

Entrance when latch retracted by key. Key removable only when locked.

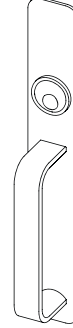



Applicable Devices

- 6300R Wide Stile Rim Device
- 6300V Wide Surface Vertical Device
- 6300C Wide Concealed Vertical Device
- 6300M Wide Mortise Device
- 6400R Narrow Rim Device
- 6400V Narrow Surface Vertical Device
- 6400C Narrow Concealed Vertical Device

6G Grip Pull Trim

| 6G | APPLICATION | FUNCTION | DESCRIPTION | 630 | 613E/622 |
|--|---|----------|-----------------------------|----------|----------|
| GRIP PULL  | Rim Surface Vertical Rod Concealed Vertical Rod | 02 | Dummy Trim (Grip Pull only) | \$166.00 | \$182.00 |
| | | 03 | Night Latch | \$220.00 | \$236.00 |

| CYLINDER OPTIONS | ICON | LOCK ADJUSTMENT |
|------------------|---|-----------------|
| SFL |  | N/C |
| LFL |  | |
| D |  | |

IC Core not included.

6GM Grip Pull Mortise Trim

| 6G | APPLICATION | FUNCTION | DESCRIPTION | 630 | 613E/622 |
|--|-------------|----------|-----------------------------|----------|----------|
| GRIP PULL  | Mortise | M02 | Dummy Trim (Grip Pull only) | \$166.00 | \$182.00 |
| | | M03 | Night Latch | \$220.00 | \$236.00 |

6300/6400
EXIT DEVICE TRIMS

6300/6400 SERIES TRIMS

LIST PRICE

Effective July 3, 2023

6S Functions

02 Pull Only

Entrance/Pull only when device is dogged. Lever is fixed.

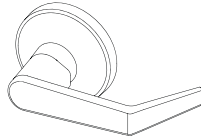

08 Classroom

Key locks or unlocks lever.

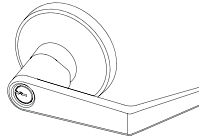

09 Storeroom

Entrance by lever when key inserted. Key removable only when locked.

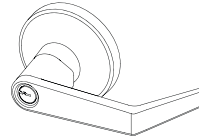

14 Passage

Entrance by lever. Always unlocked.

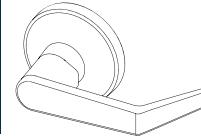

6S Lever Styles

PHL

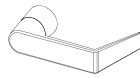

BSN



MIA

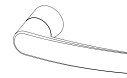

Applicable Devices

- 6300R Wide Stile Rim Device
- 6300V Wide Surface Vertical Device
- 6300C Wide Concealed Vertical Device

6S Sectional Trim

| 6S | APPLICATION | FUNCTION | DESCRIPTION | LEVER | 626 | 605/606 613E/622/ 630 |
|----|---|----------|--------------------|---------------|----------|-----------------------------|
| | Rim Surface Vertical Rod Concealed Vertical Rod | 02 | Dummy Trim | BSN, MIA, PHL | \$220.00 | \$236.00 |
| | | 08 | Classroom w/ Lever | | \$277.00 | \$293.00 |
| | | 09 | Storeroom w/ Lever | | \$250.00 | \$266.00 |
| | | 14 | Passage w/ Lever | | | |

| CYLINDER OPTIONS | ICON | LOCK ADJUSTMENT |
|------------------|------|-----------------|
| SFL | | N/C |
| LFL | | |
| D | | |

IC Core not included.

Note: LFL Prep only available in PHL lever

Note: 6S Trim shipped after March 2022 is not compatible with 6200 series exit devices. Contact factory for retrofit trim.

6300/6400
EXIT DEVICE TRIMS

6300/6400 SERIES TRIMS

LIST PRICE

Effective July 3, 2023

6C Cylinder Only



6C Cylinder Only - Order this trim option for cylinder only, Night Latch (F03) Function. Includes rim cylinder or *IC rim housing, collar, and required mounting hardware.





*IC core sold separately

How to Order

| Series | Function | Finish | Cylinder Type | Keying |
|--|---|---|---|---|
| 6C | 03 | 630 | D | SCC |
| 6C - Cylinder Only - 6300/6400 Device | 03 - Night Latch (Rim) M03 - Night Latch (Mortise) | 605 – Bright Brass 606 – Satin Brass 613E – Dark Bronze 622 – Satin Black 625 – Bright Chrome 626 – Satin Chrome 630 - Stainless Steel | D Default L Less Cylinder SF6 - SFIC prepped w/ 6 pin core SF7 - SFIC prepped w/ 7 pin core SFL - SFIC prepped but less core SFC - SFIC prepped w/ construction core SFP - SFIC prepped w/ plastic construction core LF6 - Schlage LFIC prepped w/ Schlage core LFL - Schlage LFIC prepped but less core LFC - Schlage LFIC prepped w/ construction core | SCC – Schlage C Others – See Keyway Table Page |

6300/6400
EXIT DEVICE TRIMS

6C Cylinder Only

| 6C | APPLICATION | FUNCTION | DESCRIPTION | 605/606/613E/ 619/622/625 626/630 | CYLINDER OPTIONS | ICON | LOCK ADJUSTMENT |
|--|---|----------|---------------------------------------|---|---------------------|---|--------------------|
| CYLINDER ONLY  | Rim Surface Vertical Rod Concealed Vertical Rod | 03 | 6C - Cylinder Only - 6300/6400 Device | \$133.00 | SFL |  | N/C |
| | | | | | LFL |  | |
| | | | | | D |  | |

6CM Cylinder Only

| 6C | APPLICATION | FUNCTION | DESCRIPTION | 605/606/613E/ 622/625 626/630 |
|--|-------------|----------|---|-------------------------------------|
| CYLINDER ONLY  | Mortise | M03 | 6CM - Cylinder Only - 6300 Mortise Device | \$133.00 |

IC Core not included.

6300/6400 TRIM DIMENSIONS

LIST PRICE

Effective July 3, 2023

Trim Dimensions

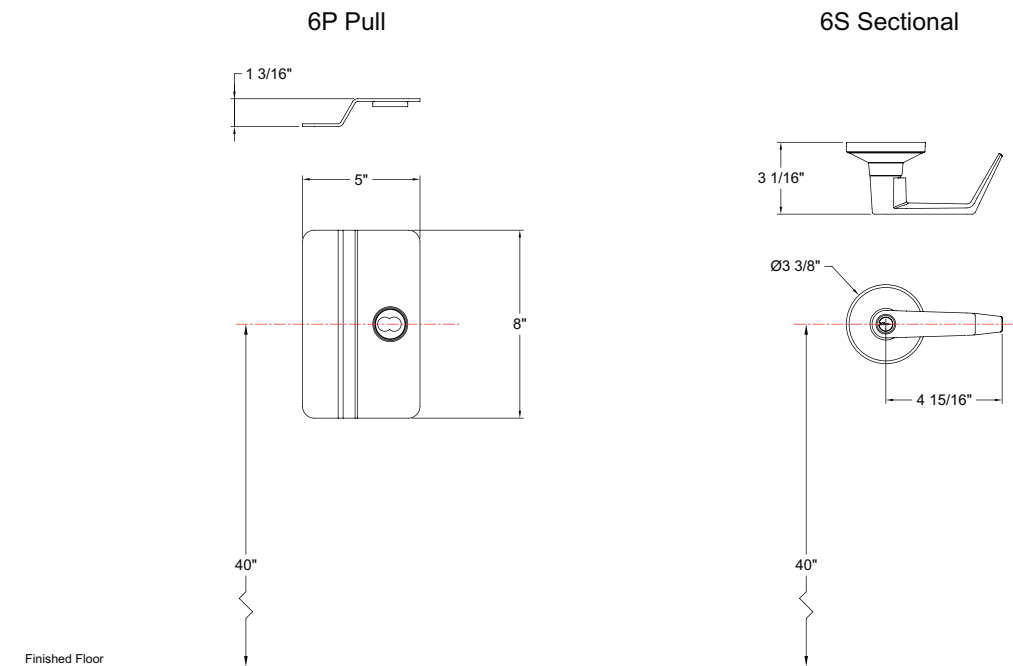
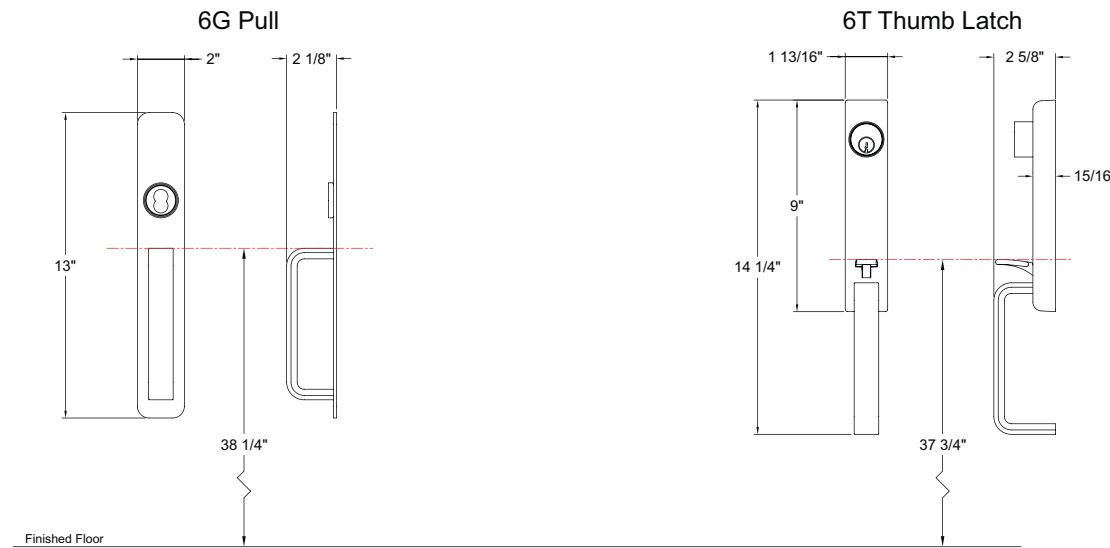
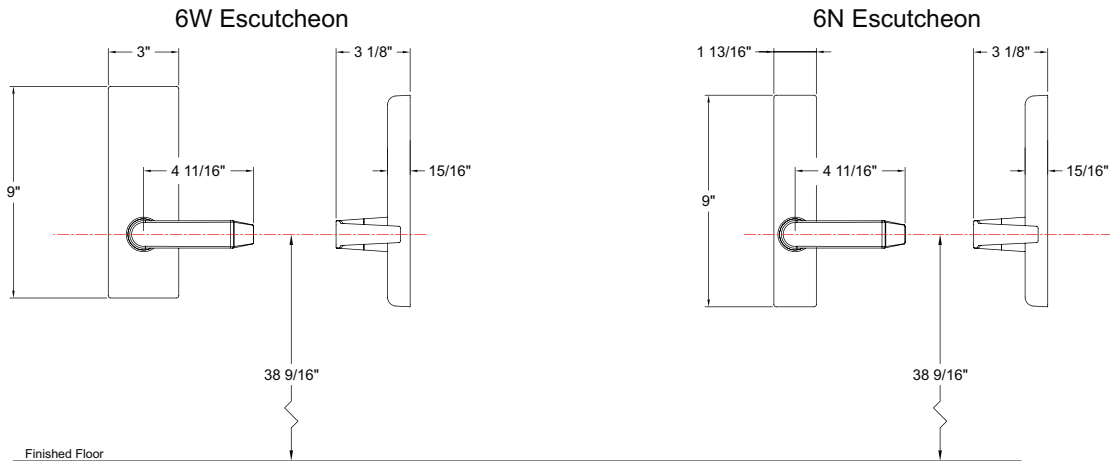

6300/6400
EXIT DEVICE TRIMS

Options

| TRIM | PART | DESCRIPTION | TRIM ADJUSTMENT |
|----------------|------|---|-----------------|
| All Trims | AM | Antimicrobial coating applied to tactile surfaces | \$90.00 |
| 6W, 6T, 6G, 6P | TD4 | Trim adapted to accommodate 2-1/2"-2-3/4" thick doors | \$42.00 |
| | TD5 | Trim adapted to accommodate up to 3" thick doors | |

Keyways

| Conventional Cylinder | | Small Format Interchangeable Core | | Large Format Interchangeable Core | |
|-----------------------|-----------------------|--|---|-----------------------------------|-----------------------|
| Keyway | PDQ Keyway Designator | Keyway (BEST Compatible) | PDQ Keyway Designator | Keyway (Schlage Compatible) | PDQ Keyway Designator |
| Schlage C (Default) | SCC | BEST A (Default), B, C, D, E, F, G, H, J, K, L, M, Q, R, WA, WB, WG, WH, TB, TD, TE, R | A (Default), B, C, D, E, F, G, H, J, K, L, M, Q, R, WA, WB, WG, WH, TB, TD, TE, R | Schlage C (Default) | SCC (Default) |
| PDQ Restricted | TA | | | | |
| Arrow AR1 | ARA | | | | |
| Corbin 59A1 | CO59A1 | | | | |
| Corbin 60 | CO6 | | | | |
| Corbin L4 | CL4 | | | | |
| Russwin D1 | RUD | | | PDQ Exclusive | PDQ1 |
| Russwin 981 | RUD981 | | | | PDQ2 |
| Schlage E | SCE | | | PDQ Exclusive and Restricted | PDQ3 |
| Schlage C | SCC | | | | |
| Schlage C-K | SCC-K | | | | |
| Sargent LA | SAL | | | | |
| Sargent RA-RC | RA-RC | | | | |
| Yale E1R | YA8 | | | | |
| Yale GA | GA | | | | |
| Falcon E-R | FAL | | | | |
| Kwikset | KW | | | | |

Keying

| Description | PDQ Keying Designator |
|---------------------------|-----------------------|
| Keyed Different (Default) | KD |
| Keyed Alike | KA |
| "O" Zero Bitted | KO |
| Master Keyed | MK |
| Construction Master Keyed | CMK |
| Grand Master Keyed | GMK |

6300/6400 SERIES TRIMS

LIST PRICE

Effective July 3, 2023

Keyways and Cylinders

| PDQ KEYWAY | COMPATIBLE WITH | SOLD WITH LOCK |
|------------|---|----------------|
| AR1 | Arrow / AR1 | N/C |
| CO59A1 | Corbin / 59A1 | |
| CO6 | Corbin / 60 | |
| CL4 | Corbin / L4 | |
| RUD | Russwin / D1 | |
| SCE | Schlage / E | |
| SCC | Schlage / C | |
| SCC-K | Schlage / C-K | |
| SAL | Sargent / LA | |
| RA-RC | Sargent / RA-RC | |
| YA8 | Yale / E1R | |
| GA | Yale / GA | |
| FAL | Falcon / E-R | |
| KW | Kwikset | |
| TA | PDQ / TA (Restricted. Limited to Grandmaster systems w/4 masters) | |
| Dummy | — | |
| T-Turn | — | |
| L | Less Cylinder | Deduct \$4.00 |

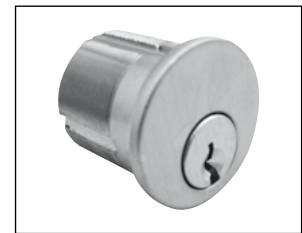

Mortise Cylinder



UL 437 and High Security Cylinders

HIGH SECURITY CYLINDERS AND CORES
SEE HIGH SECURITY CYLINDERS AND CORES SECTION, PAGE 118.

- NOTES:**
- Uncombined cores do not include springs & pins
 - Combined cores include master keying in the list price
 - **PDQ1, PDQ2, PDQ3 (Restricted)**
BEST A2 & A4 Systems Available
 - Control Keys must be ordered separately

Cores and Keyways

| DESCRIPTION | PDQ NO. | ADD |
|--|------------------|---------|
| SMALL FORMAT UNCOMBINED | | |
| 6 Pin Cores | I5206 + KEYWAY | \$40.00 |
| 7 Pin Cores | I5207 + KEYWAY | |
| COMBINATED | | |
| 6 Pin Cores | I5206-1 + KEYWAY | \$60.00 |
| 7 Pin Cores | I5207-1 + KEYWAY | |
| BEST Compatible | | |
| A (DEFAULT), B, C, D, E, F, G, H, J, K, L, M, Q, | | |
| WA, WB, WC, WG, WH, TB, TD, TE, & R | | |
| PDQ Exclusive | | |
| PDQ1, PDQ2 | | |
| PDQ Exclusive and Restricted | | |
| PDQ3 | | |
| SFIC CONSTRUCTION | | |
| Construction Core 6-pin only | | \$60.00 |
| Dummy Construction Core Plastic | | \$8.00 |
| LFIC CONSTRUCTION | | |
| Construction Core 6-pin only | | \$70.00 |
| IC Tailpiece Assembly Construction cores are invoiced at shipment and credited upon return. | | |
| | | \$10.00 |
| LFIC COMBINATED | | |
| Schlage compatible LFIC, SCC (Schlage C compatible) keyway | | \$70.00 |
| PDQ TA LFIC Restricted | | |
| LFIC UNCOMBINED | | |
| Schlage compatible LFIC, SCC (Schlage C compatible) keyway | | \$50.00 |
| HIGH SECURITY IC CORES | | |
| SEE HIGH SECURITY CYLINDERS AND CORES SECTION, PAGE 118. — LFIC REQUIRES LARGE FORMAT LEVER | | |

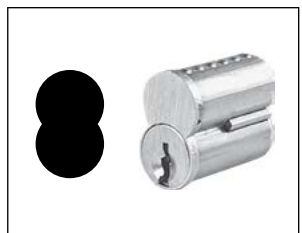

SFL/SFIC Core

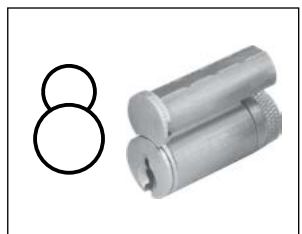

LFL/LFIC Schlage Format



IC Mortise Housing

6300/6400
EXIT DEVICE TRIMS

6300/6400 SERIES TRIMS

LIST PRICE

Effective July 3, 2023

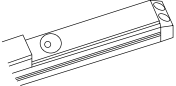
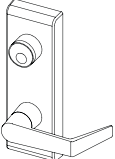
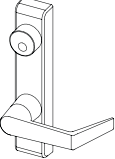
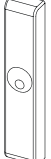
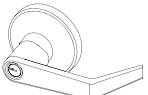
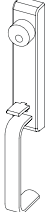
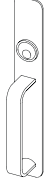
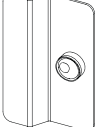
| TRIM TYPE | FUNCTION | IMAGE | STANDARD CYLINDER | BEST SFIC | SCHLAGE STYLE LFIC |
|-----------------------------------|---------------------------|---|--|---|---|
| 6C | 03 (Less Outside Trim) |  | Rim cylinder (use rim cylinder included collar, mounting plate & screws) | SFIC Rim Housing (use rim housing included collar, mounting plate & screws) | LFIC Rim Housing (use rim housing included collar, mounting plate & screws) |
| CYLINDER DOGGING/ALARM KIT | All Devices |  | 1-1/8" Mortise Cylinder 631093 Trim Ring Yale Cam | SFIC 7 pin housing (2) 631093 Trim Rings Yale Cam | LFIC housing 631094 Collar (5/8") Yale Cam |
| 6W | All Keyed Functions |  | 1-1/8" Mortise Cylinder 631094 Collar (5/8") Corbin A01 or Yale Cam | SFIC 7 pin housing 631094 Collar Flipped (3/4") 631093 Trim Ring Corbin A01 or Yale Cam | LFIC housing 631094 Collar Flipped (3/4") 631093 Trim Ring Corbin A01 or Yale Cam |
| 6N | 08, 09 |  | 1-1/8" Mortise Cylinder 631094 Collar (5/8") Corbin A01 or Yale Cam | SFIC 7 pin housing 631094 Collar Flipped (3/4") 631093 Trim Ring Corbin A01 or Yale Cam | LFIC housing 631094 Collar Flipped (3/4") 631093 Trim Ring Corbin A01 or Yale Cam |
| 6N | 03 |  | Rim Cylinder | SFIC rim housing | LFIC rim housing |
| 6S | All Keyed Functions |  | Must order product with KIK / Standard cylinder lever | Must order product with SFIC lever | Must order product with Schlage style LFIC Lever |
| 6T | All Keyed Functions |  | 1-1/8" Mortise Cylinder 631094 Collar (5/8") Corbin A01 or Yale Cam | SFIC 7 pin housing 631094 Collar Flipped (3/4") 631093 Trim Ring Corbin A01 or Yale Cam | LFIC housing 631094 Collar Flipped (3/4") 631093 Trim Ring Corbin A01 or Yale Cam |
| 6G | All Keyed Functions |  | Rim Cylinder Standard rim cylinder trim ring | SFIC rim housing Standard rim cylinder trim ring | LFIC rim housing Standard rim cylinder trim ring |
| 6P | All Keyed Functions |  | Rim Cylinder Standard rim cylinder trim ring | SFIC rim housing Standard rim cylinder trim ring | LFIC rim housing Standard rim cylinder trim ring |

6300/6400
EXIT DEVICE TRIMS

Trim Compatibility (Narrow/Medium Stile Aluminum Doors)

| Stile | Device Type | Compatible Trims |
|----------------------|---------------------------|---|
| 2 - 1/8" Stile Doors | 6400 Narrow Stile Devices | 6C Cylinder only: Function (03) |
| | | 6C Cylinder with 9E Pull: Function (03) Note: Pull for 6400 CVR Device must be 10"CTC |
| 3 - 1/2" Stile Doors | 6400 Narrow Stile Devices | 6C Cylinder only: Function (03) |
| | | 6C Cylinder with 9E Pull: Function (03) Note: Pull for 6400 CVR Device must offset from device centerline if other than 10"CTC |
| | | 6N Escutcheon: Function (01, 02, 03, 08, 09, 14) |
| | | 6T Escutcheon: Function (02, 05, 06, 15) Note: This trim does not work on 6400 CVR Device |
| | | 6G Pull: Function (02, 03) |
| 3 - 1/2" Stile Doors | 6300 Wide Stile Devices | 6C Cylinder only: Function (03) |
| | | 6C Cylinder with 9E Pull: Function (03) |
| | | 6W Escutcheon: Function (02, 08, 09, 14, 99) |
| | | 6N Escutcheon: Function (01, 02, 03, 08, 09, 14) |
| | | 6T Escutcheon: Function (02, 05, 06, 15) |
| | | 6P Pull: Function (03) |
| | | 6G Pull: Function (02, 03) |

Trim Compatibility (Steel/Wood Doors)

| Device Type | Compatible Trims |
|---------------------------|--|
| 6400 Narrow Stile Devices | 6C Cylinder only: Function (03) |
| | 6C Cylinder with 9E Pull: Function (03) |
| | 6N Escutcheon: Function (01, 02, 03, 08, 09, 14) |
| | 6T Escutcheon: Function (02, 05, 06, 15) Note: This trim does not work on 6400 CVR Device |
| | 6G Pull: Function (02, 03) |
| 6300 Wide Stile Devices | 6C Cylinder only: Function (03) |
| | 6C Cylinder with 9E Pull: Function (03) |
| | 6W Escutcheon: Function (02, 08, 09, 14, 99) |
| | 6N Escutcheon: Function (01, 02, 03, 08, 09, 14) |
| | 6T Escutcheon: Function (02, 05, 06, 15) |
| | 6P Pull: Function (03) |
| | 6G Pull: Function (02, 03) |

9300 SERIES

Mullions

9300 Mullion

The PDQ 9300 Series removable mullions are designed for use with the 6300/6400 Series Rim Exit Devices on pairs of doors. They are designed for quick removal from the top bracket by simple operation of the rim cylinder when a clear, unobstructed large opening is required. Once the mullion is removed, carts, gurneys, large machinery and the like can freely pass through the opening. When the mullion is re-installed, the unit will self lock in place without a key.

Specifications

| | |
|---|--|
| Mullion Head/Foot brackets: | • Cast Stainless Steel |
| Tube Dimensions: | • Powder Coated 2" x 3" Steel - 3/16" Wall |
| Strike: | • 639080 Strike included for Fire Labeled • Strike not included for panic mullion. Use supplied strike with exit device. |
| Size: | • 8' or 10' lengths - Can easily be cut to shorter size in field |
| Finish: | • Powder Coated 689 (Aluminum) • 600 - Primed for Painting |
| Electrified Options: | • Wire routing w/ plugs |
| Warranty: | • One (1) year limited warranty |
| Certifications: Compliances: Listings: | • Fire model is 3 hour fire labeled for pairs up to and including 8' x 8' (With 6300RF/6400RF Rim Device) • Meets requirements of the BAA as a COTS product manufactured in the United States |

Orientation

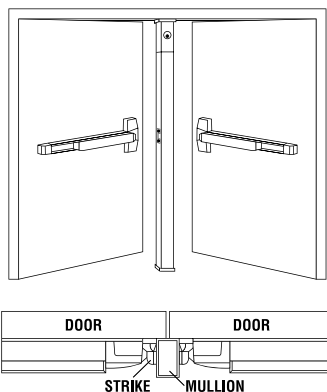

Key Removable



Non-Keyed Removable

How to order

| DEVICE TYPE | FOR DOOR HEIGHT | REMOVABLE TYPE | RATING | FINISH | OPTIONS | KEYING |
|---------------------|---|--|---|--|---------------------------------|----------------------|
| 93 | 0 | 0 | — | 689 | — | |
| 93 - Mullion | 0 - 8' and under Door 1 - 10' and under Door | 0 - Key Removable 1 - Non-Keyed Removable | Blank - Non Fire Rated F - Fire Rated (8' Max) | 689 - Aluminum 600 - Primer | EM - Electrified Mullion | See Next Page |

Mullions - Key Removable

| PART | DESCRIPTION | 689/600 |
|-----------|--|-----------|
| 9300-689 | Mullion, 8' non-fire rated and under opening height (can be cut down to non standard opening height) | \$1065.00 |
| 9300F-689 | Mullion, 8' Listed to UL10C for Fire and under opening height (can be cut down to non standard opening height) | \$1325.00 |
| 9310-689 | Mullion, 10' and under opening height (can be cut down to non standard opening height) | \$1204.00 |

Mullions - Hex Key Removable

| PART | DESCRIPTION | 689/600 |
|-----------|--|-----------|
| 9301-689 | Mullion, 8' and under opening height (can be cut down to non standard opening height) | \$771.00 |
| 9301F-689 | Mullion, 8' Listed to UL10C for Fire and under opening height (can be cut down to non standard opening height) | \$1031.00 |
| 9311-689 | Mullion, 10' and under opening height (can be cut down to non standard opening height) | \$910.00 |

Electrified Mullion



| PART | DESCRIPTION | 689/600 |
|--------------|---|-----------|
| 9300-689-EM | Mullion, removable by cylinder, 8' and under opening height (can be cut down to non standard opening height), Factory electrified routing prep using Industry standard moxex connectors | \$1348.00 |
| 9300F-689-EM | Mullion, Listed to UL10C for Fire, removable by cylinder, 8' and under opening height (can be cut down to non standard opening height), Factory electrified routing prep using Industry standard moxex connectors | \$1608.00 |
| 9301-689-EM | Mullion, removable by use of hex key, 8' and under opening height (can be cut down to non standard opening height), Factory electrified routing prep using Industry standard moxex connectors | \$1054.00 |
| 9301F-689-EM | Mullion, Listed to UL10C for Fire, removable by use of hex key, 8' and under opening height (can be cut down to non standard opening height), Factory electrified routing prep using Industry standard moxex connectors | \$1314.00 |
| 9310-689-EM | Mullion, removable by cylinder, 10' and under opening height (can be cut down to non standard opening height), Factory electrified routing prep using Industry standard moxex connectors | \$1487.00 |
| 9311-689-EM | Mullion, removable by use of hex key, 10' and under opening height (can be cut down to non standard opening height), Factory electrified routing prep using Industry standard moxex connectors | \$1193.00 |

Notes:

- 1. Fire Rated mullion listed only when used with PDQ's 6300/6400 Fire Rated Devices. Use with any other device will void UL Fire Rating.**
- 2. Mullions shipped UPS will be assessed an \$8.00 handling up charge.**

Key Removable Only

| CYLINDER TYPE | KEYWAY | KEYING |
|---|---|--|
| D | SCC | KD |
| D Default L Less Cylinder SF6 Lock is SFIC prepped w/ 6 pin core SF7 Lock is SFIC prepped w/ 7 pin core SFL Lock is SFIC prepped but less core SFC Lock is SFIC prepped w/ construction core SFP Lock is SFIC prepped w/ plastic construction core LF6 Lock is Schlage LFIC prepped w/ Schlage core LFL Lock is Schlage LFIC prepped but less core LFC Lock is Schlage LFIC prepped w/ construction core | SCC – Schlage C OTHERS – See Keyway Table Page 176 | KD – Keyed Different KA – Keyed Like KO – Zero Bitted MK – Master Keyed CMK – Construction Keyed GMK – Grand Master Keyed |

| CYLINDER OPTIONS | ICON | LOCK ADJUSTMENT |
|------------------|---|-----------------|
| SFL |  | N/C |
| LFL |  | |
| D |  | |

IC Core not included.

639081 - Mullion Storage Kit

- Kit includes items necessary to mount/store mullion on the wall when not in use.



Accessories

| PART | DESCRIPTION | LIST PRICE |
|--------|--|------------|
| 631617 | Mullion Fire Strike (Includes fasteners) | \$50.00 |
| 639081 | Mullion Storage Kit | \$188.00 |

Note: Strike sold as replacement only. Must provide Order number of previous purchased item.



4200 Series Commercial Wide Stile

Architectural Finishes. No Plastic Parts.

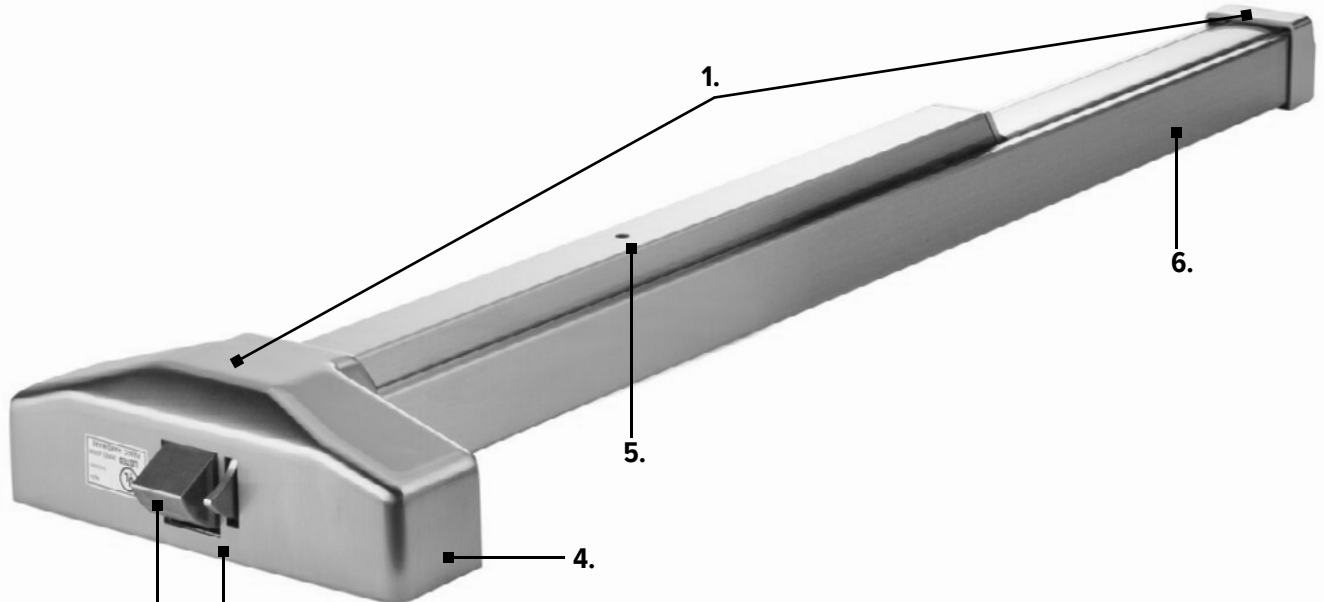

- 1. Metal end caps and chassis cover
- 2. Stainless steel latch bolt with 3/4" throw (rim shown), 5/8" throw (vertical rod devices)
- 3. Deadlocking feature provides tamper resistance (rim shown)
- 4. Corrosion resistant steel plated chassis
- 5. Hex key dogging (Dogging not available with fire labeled devices)
- 6. Heavy gauge roll formed steel or stainless steel rail

Decorative Finish Collection

Architectural

- 605 Bright Brass, Clear Coated
- 626 Satin Chromium Plated
- 630 Satin Stainless Steel

Painted

- 689 Aluminum
- 695 Dark Bronze
- 696 Gold



How to Order

| QUANTITY | SERIES | DOGGING | APPLICATION | LABELING | SIZE | FINISH |
|----------|--------|--|---|---|---|--|
| 10 | 42 | 00 | R | F | A | 630 |
| | | 00 – Hex Key Dogging (Standard) Dogging Not Furnished With Fire Listed Devices | R – Rim V – Surface Vertical Rod | F – Fire Listed, Max. 3' Door Width No Designation – Panic | BLANK – 3' doors (Default) A – Doors up to 4' Consult Door Width Chart to determine correct device for your application | 605 – Polished Brass 626 – Satin Chrome 630 – Satin Stainless Steel 689 – Aluminum 695 – Duro Bronze 696 – Gold |

Door Width Chart

| PART | DESCRIPTION | FOR DOOR | MIN DOOR | MAX CUT | PUSH PAD |
|--------|--------------------------|----------|----------|---------|----------|
| 4200R | 4200 Rim Regular dogging | 36" | 27" | 9" | 18" |
| 4200RF | 4200 Rim Fire Listed | 36" | 27" | 9" | 18" |
| 4200V | 4200 SVR Regular dogging | 36" | 27" | 9" | 18" |
| 4200VF | 4200 SVR Fire Listed | 36" | 27" | 9" | 18" |
| 4200RA | 4200 Rim Regular dogging | 48" | 39" | 9" | 30" |
| 4200VA | 4200 SVR Regular dogging | 48" | 39" | 9" | 30" |

Cross Reference

| DESCRIPTION | PDQ | CAL ROYAL | CORBIN/RUSSWIN | DORMA | FALCON | HAGER | PRECISION | SARGENT | S PARKER | TELL | VON DUPRIN | YALE |
|----------------------|-------|-----------|----------------|-------|--------|----------|-----------|---------|----------|------|------------|------|
| RIM | 4200R | 2200 | ED8200 | 8300 | 19 R | 4700 Rim | 5100 | 2828 | UL520 | 8300 | 22 | 2100 |
| SURFACE VERTICAL ROD | 4200V | 2260 | ED8400 | 8400 | 19 V | 4700 SVR | 5200 | 2727 | 520V | 8400 | 2227 | 2110 |

4200R SERIES

Commercial Wide Stile Rim Exit Device

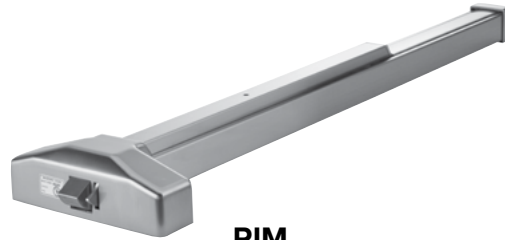

RIM
ANSI TYPE 1



ADA COMPLIANT

Specifications

| | |
|---|--|
| CHASSIS: | • Corrosion resistant plated steel |
| RAIL: | • Heavy gauge steel or stainless steel |
| LATCH: | • RIM (R) – 3/4" throw |
| BACKSET: | • 2-3/4" Backset Compatible with 161 prep |
| HAND: | • Device is non-handed |
| DOGGING: | • Hex key dogging standard • Dogging not available on fire listed devices |
| MINIMUM STILE WIDTH: | • 4-1/4" for device (exit only) • Minimum stile requirements with trim varies by trim type |
| DOOR THICKNESS: | • 1-3/4" standard |
| DOOR WIDTH: | • Standard for 3 ft doors, option available for doors up to 4' |
| FINISHES: | • 605 – Polished Brass, 626 – Satin Chrome, 630 – Satin Stainless Steel, 689 – Aluminum, 695 – Duro Bronze, 696 – Gold |
| FASTENERS: | • Includes machine screws and wood screws • Sex nuts supplied with all Fire Listed devices |
| WARRANTY: | • Five (5) year limited warranty |
| CERTIFICATIONS, LISTINGS, COMPLIANCES: | • UL 305 listed for "Panic" , UL listed for "Fire Exit Hardware" labeled for up to 1-1/2 hours, 3'0" x 7'0" Max Size • Complies with ADA (Americans with Disabilities Act) and ICC/ANSI 117.1 for Accessible and Usable Buildings • TAA compliant. Country of origin: Taiwan |

Rim Exit Device

| PART | DESCRIPTION | 689/695/696 | 630 | 605/626 |
|--------|--|-------------|----------|----------|
| 4200R | Rim, UL panic listed, hex key dogging, 3'0" door | \$282.00 | \$442.00 | \$382.00 |
| 4200RA | Rim, UL panic listed, hex key dogging, 4'0" door | \$324.00 | \$484.00 | \$424.00 |
| 4200RF | Rim, UL fire listed, no dogging, 3'0" door | \$433.00 | \$593.00 | \$533.00 |

4200V SERIES

Commercial Wide Stile Surface Vertical Rod Exit Device

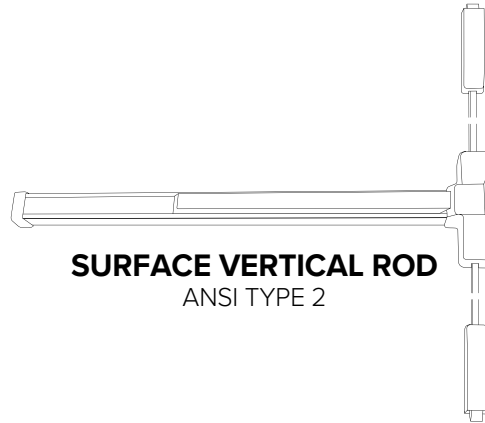

SURFACE VERTICAL ROD
ANSI TYPE 2



Specifications

| | |
|---|--|
| CHASSIS: | • Corrosion resistant plated steel |
| RAIL: | • Heavy gauge steel or stainless steel |
| LATCH: | • SURFACE VERTICAL ROD (V) – Top Latch-Pullman with dead latching 5/8" throw • Bottom Latch- Pullman with 5/8" throw, held retracted during door swing |
| BACKSET: | • 2-3/4" Backset Compatible with 161 prep |
| HAND: | • Device is non-handed |
| DOGGING: | • Hex key dogging standard • Dogging not available on fire listed devices |
| MINIMUM STILE WIDTH: | • 4-1/4" for device (exit only) • Minimum stile requirements with trim varies by trim type |
| DOOR THICKNESS: | • 1-3/4" standard |
| DOOR WIDTH: | • Standard for 3 ft doors, option available for doors up to 4' |
| FINISHES: | • 605 – Polished Brass, 626 – Satin Chrome, 630 – Satin Stainless Steel, 689 – Aluminum, 695 - Duro Bronze, 696 – Gold |
| FASTENERS: | • Includes machine screws and wood screws • Sex nuts supplied with all Fire Listed devices |
| VERTICAL RODS: | • Stock for 7' doors standard. Rod extensions available for doors up to 10'. |
| WARRANTY: | • Five (5) year limited warranty |
| CERTIFICATIONS, LISTINGS, COMPLIANCES: | • UL 305 listed for "Panic", UL listed for "Fire Exit Hardware" labeled for pair of doors up to 1-1/2 hours, 6'0" x 7'0" Max Opening • Complies with ADA (Americans with Disabilities Act) and ICC/ANSI 117.1 for Accessible and Usable Buildings • TAA compliant. Country of origin: Taiwan |

Surface Vertical Rod Exit Device

| PART | DESCRIPTION | 689/695/696 | 630 | 605/626 |
|--------|---|-------------|----------|----------|
| 4200V | Surface vertical rod, UL panic listed, hex key dogging, 3'0" door | \$539.00 | \$699.00 | \$639.00 |
| 4200VA | Surface vertical rod, UL panic listed, hex key dogging, 4'0" door | \$581.00 | \$741.00 | \$681.00 |
| 4200VF | Surface vertical rod, UL fire listed, no dogging, 3'0" door | \$690.00 | \$850.00 | \$790.00 |

4200 SERIES

Commercial Wide Stile Exit Device Trim

Lever Styles



BOSTON — BSN
4SH TRIM ONLY



MIAMI — MIA
4SH TRIM ONLY



PHILADELPHIA — PHL

ALL LEVERS

Trim Types



EW - ESCUTCHEON
WIDE



EN - ESCUTCH-
EON NARROW



GW - GRIP PULL
WIDE



S - SECTIONAL
LEVER



P03 - PULL



P02 - PULL



P01 - PLATE



K - SECTIONAL KNOB

How to Order

| QUANTITY | SERIES | TYPE | FUNCTION | LEVER | HANDING | FINISH | DOOR THICKNESS | CYLINDER OR HOUSING | KEYWAY | KEYING |
|----------|--------|-----------------------------------|-------------------------------------|---------------------------|------------|--|--|---------------------|-----------------|--------|
| 10 | 4 | EW | 08 | PHL | — | 626 | — | D | SCC | KD |
| | | K — Knob | 01 — Exit only | BSN — Boston | RHR | 605 — Bright Brass | 1- 3/4 - 2" | D Default | PAGE 183 | |
| | | GW — Grip Pull, Wide Stile | 02 — Dummy Trim | MIA — Miami | LHR | 606 — Satin Brass | L Less Cylinder | | | |
| | | P01 — Plate | 03 — Night Latch | PHL — Philadelphia | | 613E — Dark Oxidized Satin Bronze | SF6 Lock is SFIC prepped w/ 6 pin core | | | |
| | | P02 — Pull | 05 — Classroom w/Thumb Piece | | | 626 — Satin Chrome | SF7 Lock is SFIC prepped w/ 7 pin core | | | |
| | | S — Sectional, Heavy Duty | 08 — Classroom w/Lever | | | 630 — Satin Stainless Steel | SFL Lock is SFIC prepped but less core | | | |
| | | EN* — Escutcheon, Narrow | 09 — Storeroom w/Lever | | | | SFC Lock is SFIC prepped w/ construction core | | | |
| | | EW* — Escutcheon, Wide | 14 — Passage w/Lever | | | | SFP Lock is SFIC prepped w/ plastic construction core | | | |
| | | | 15 — Passage w/Thumb Piece | | | | LF6 Lock is Schlage LFIC prepped w/ Schlage core | | | |
| | | | | | | | LFL Lock is Schlage LFIC prepped but less core | | | |
| | | | | | | | LFC Lock is Schlage LFIC prepped w/ construction core | | | |
| | | | | | | | PAGE 183 | | | |

* EN/EW trim available with PHL lever only.





Wide Stile Trim

| STYLE | | FUNCTION | DESCRIPTION | TRIM TYPE | 605 | 613E | 626 | 689/695 | |
|-------|---|----------|--------------------------|-------------|----------|------|----------|----------|----------|
| 4EW |  | 02 | Dummy Trim (Rigid Lever) | 4 EW 02 PHL | \$304.00 | | \$289.00 | - | |
| | | 08 | Classroom w/ Lever | 4 EW 08 PHL | \$317.00 | | \$302.00 | | |
| | | 09 | Storeroom w/ Lever | 4 EW 09 PHL | | | | | |
| | | 14 | Passage w/ Lever | 4 EW 14 PHL | \$304.00 | | \$289.00 | | |
| 4EN |  | 02 | Dummy Trim (Rigid Lever) | 4 EN 02 PHL | \$164.00 | - | \$149.00 | \$134.00 | |
| | | 08 | Classroom w/ Lever | 4 EN 08 PHL | \$182.00 | | | \$167.00 | \$152.00 |
| | | 09 | Storeroom w/ Lever | 4 EN 09PHL | | | | | |
| | | 14 | Passage w/ Lever | 4 EN 14 PHL | \$164.00 | | | \$149.00 | \$134.00 |

| STYLE | | FUNCTION | DESCRIPTION | TRIM TYPE | 605/606/613E | 626 | 689/695 |
|-------|--|----------|--------------------------|----------------------|--------------|----------|---------|
| 4S |  <p>Sectional lever trim not compatible when using SNB to through bolt device chassis</p> | 02 | Dummy Trim (Rigid Lever) | 4 S 02 BSN, MIA, PHL | \$150.00 | \$135.00 | - |
| | | 08 | Classroom w/ Lever | 4 S 08 BSN, MIA, PHL | \$204.00 | \$189.00 | |
| | | 09 | Storeroom w/Lever | 4 S 09 BSN, MIA, PHL | | | |
| | | 14 | Passage w/ Lever | 4 S 14 BSN, MIA, PHL | \$150.00 | \$135.00 | |

Note: For functions and finishes not shown, contact PDQ Customer Service.



| CYLINDER OPTIONS | ICON | LOCK ADJUSTMENT |
|------------------|---|-----------------|
| SFL |  | N/C |
| LFL |  | |

IC Core not included see page 192 for core options.

Wide Stile Trim

| STYLE | FUNCTION | DESCRIPTION | TRIM TYPE | 605 | 613E | 626 | 630 | 689/695 | |
|--|----------|-----------------------------|-----------|----------|------|-----|---------|----------|---------|
| 4K  | 08 | Classroom | 4 K 08 | - | - | - | \$74.00 | - | |
| | 14 | Passage | 4 K 14 | | | | \$36.00 | | |
| 4P  PLATE TRIM PULL TRIM | 01 | Exit Only | 4 P 01 | | - | - | - | \$36.00 | \$36.00 |
| | 02 | Dummy Pull Trim | 4 P 02 | | | | | \$68.00 | |
| | 03 | Night Latch | 4 P 03 | \$154.00 | | | | | |
| 4GW  | 02 | Dummy Trim (Grip Pull only) | 4 GW 02 | \$184.00 | - | - | - | \$154.00 | |
| | 03 | Night Latch | 4 GW 03 | | | | | \$184.00 | |
| | 05 | Classroom w/Thumb Piece | 4 GW 05 | | | | | \$199.00 | |
| | 15 | Passage w/Thumb Piece | 4 GW 15 | | | | | \$169.00 | |

* Specify handing. For functions and finishes not shown, contact PDQ Customer Service.

| CYLINDER OPTIONS | ICON | LOCK ADJUSTMENT |
|------------------|---|-----------------|
| SFL |  | N/C |
| LFL |  | |

IC Core not included see page 183 for core options

Accessories

| PART (SPECIFY FUNCTION) | DESCRIPTION | LIST PRICE PLATED (605/626/630) | LIST PRICE PAINTED (689/695/696) |
|-------------------------------|---|------------------------------------|-------------------------------------|
| 429020 | Top surface vertical rod for 7'0" door | \$56.00 | \$44.00 |
| 429021 | 1' extension, vertical rod (specify finish)* | | |
| 429023 | 3' extension, vertical rod (specify finish)* | | |
| 429024 | Bottom surface vertical rod (specify finish)* | | |
| 429001 | Sex nut and bolt set | \$33.00 | \$21.00 |
| 429002 | Plate, Latch Filler-covers Type 160 or 161 prep | \$10.00 | N/A |
| 429003 | Plate, Strike filler | | |
| 429005 | Strike, SVR Top, Fire and Panic w/2 ea. 1/16" shims | \$17.00 | |
| 429006 | Strike, SVR Bottom, Fire and Panic w/2 ea. 1/16" shims | | |
| 429036 | Strike, Rim, Fire and Panic | | |
| 429019 | Double door strike | \$33.00 | |
| 429014 | Trim back plate (2-1/2" x 8"), use w/narrow escutcheon to cover 161 prep | \$21.00 | |
| 429017 | Trim back plate (3-1/2" x 8"), use w/narrow escutcheon to cover 161 prep | \$42.00 | |
| 429018 | Adapter plate | \$10.00 | |
| 429150 | Universal Glass Bead Kit - Includes 2 ea. 1/8" spacers for chassis, end cap and rod guides. | \$79.00 | |
| 429043 | Dogging Key | \$8.00 | |

*Not for Fire Rated Devices

4200 SERIES

LIST PRICE

Effective July 3, 2023

Keyways and Cylinders

| PDQ KEYWAY | COMPATIBLE WITH | SOLD WITH LOCK |
|--|---|----------------|
| AR1 | Arrow / AR1 | N/C |
| CO59A1 | Corbin / 59A1 | |
| CO6 | Corbin / 60 | |
| CL4 | Corbin / L4 | |
| RUD | Russwin / D1 | |
| SCE | Schlage / E | |
| SCC | Schlage / C | |
| SCC-K | Schlage / C-K | |
| SAL | Sargent / LA | |
| RA-RC | Sargent / RA-RC | |
| YA8 | Yale / E1R | |
| GA | Yale / GA | |
| FAL | Falcon / E-R | |
| KW | Kwikset | |
| TA | PDQ / TA (Restricted. Limited to Grandmaster systems w/4 masters) | |
| Dummy | — | |
| T-Turn | — | |
| L | Less Cylinder | |
| HIGH SECURITY CYLINDERS AND CORES | | |
| SEE HIGH SECURITY CYLINDERS AND CORES SECTION, PAGE 118. | | |

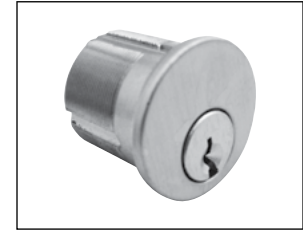

Mortise Cylinder



UL 437 and High Security Cylinders

NOTES:

- Uncombined cores do not include springs & pins
- Combined cores include master keying in the list price
- **PDQ1, PDQ2, PDQ3 (Restricted)**
BEST A2 & A4 Systems Available
- Control Keys must be ordered separately

Cores and Keyways

| DESCRIPTION | PDQ NO. | ADD |
|---|------------------|---------|
| SMALL FORMAT UNCOMBINATED | | |
| 6 Pin Cores | I5206 + KEYWAY | \$40.00 |
| 7 Pin Cores | I5207 + KEYWAY | |
| COMBINATED | | |
| 6 Pin Cores | I5206-1 + KEYWAY | \$60.00 |
| 7 Pin Cores | I5207-1 + KEYWAY | |
| BEST™ Compatible | | |
| A (DEFAULT), B, C, D, E, F, G, H, J, K, L, M, Q, | | |
| WA, WB, WC, WG, WH, TB, TD, TE, & R | | |
| PDQ Exclusive | | |
| PDQ1, PDQ2 | | |
| PDQ Exclusive and Restricted | | |
| PDQ3 | | |
| SFIC CONSTRUCTION | | |
| Construction Core 6-pin only | | \$60.00 |
| Dummy Construction Core Plastic | | \$8.00 |
| LFIC CONSTRUCTION | | |
| Construction Core 6-pin only | | \$70.00 |
| IC Tailpiece Assembly Construction cores are invoiced at shipment and credited upon return. | | |
| | | \$10.00 |
| LFIC COMBINATED | | |
| Schlage compatible LFIC, SCC (Schlage C compatible) keyway | | \$70.00 |
| PDQ TA LFIC Restricted | | |
| LFIC UNCOMBINATED | | |
| Schlage compatible LFIC, SCC (Schlage C compatible) keyway | | \$50.00 |
| HIGH SECURITY IC CORES | | |
| SEE HIGH SECURITY CYLINDERS AND CORES SECTION, PAGE 118. — LFIC REQUIRES LARGE FORMAT LEVER | | |

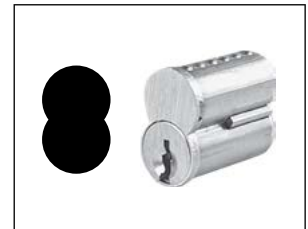

SFL/SFIC Core



LFL/LFIC Schlage Format



IC Mortise Housing



ANSI Trim Functions

| ANSI FUNCTION | DESCRIPTION |
|---------------|---|
| 01 | Exit only, no trim or blank escutcheon. |
| 02 | Entrance by trim when actuating bar is locked down (dummy trim). |
| 03 | Entrance by trim when latch is released by key. Key removable only when locked (night latch). |
| 05 | Entrance by thumb piece. Key locks or unlocks thumb piece (classroom thumb piece). |
| 08 | Entrance by knob or lever. Key locks or unlocks knob or lever (classroom knob/lever). |
| 09 | Entrance by knob or lever only when released by key. Key removable when locked. |
| 14 | Entrance by trim when latch bolt is released by knob or lever. Always active, no cylinder (passage knob/lever). |
| 15 | Entrance by trim when latchbolt is released by thumb piece. Always active, no cylinder (passage thumb piece). |

*All functions not available in every trim style

Finishes

| CODE | TYPE | DESCRIPTION |
|-------------|---------------|--|
| 605 (US3) | Architectural | Bright Brass, Clear Coated |
| 613E | Architectural | Dark Oxidized Satin Bronze, No Coating |
| 626 (US26D) | Architectural | Satin Chromium Plated, No Coating |
| 630 (US32D) | Architectural | Satin Stainless Steel, No Coating |
| 689 (US28) | Color | Aluminum |

*All finishes not available in every trim style

Handing

Out Swing Door

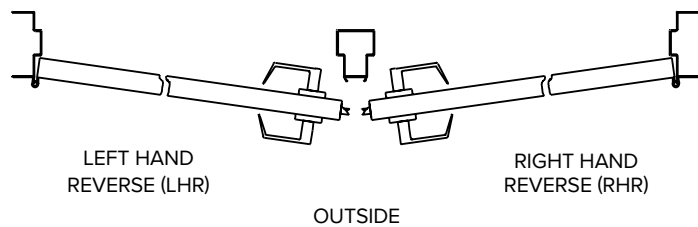

Default Trim Cylinder Reference Guide

| ANSI FUNCTION | DESCRIPTION | EW ESCUTCHEON WIDE | EN ESCUTCHEON NARROW | S SECTIONAL LEVER | P PLATE | GW GRIP PULL, WIDE STILE | K SECTIONAL KNOB |
|---------------|-------------------------|--------------------|----------------------|-------------------|---------|--------------------------|-------------------|
| 03 | Night Latch | — | — | — | RIM | RIM | — |
| 05 | Classroom w/Thumb Piece | — | — | — | — | Mortise | — |
| 08 | Classroom w/Lever | Mortise | Mortise | Key in Knob/Lever | — | — | Key in Knob/Lever |
| 09 | Storeroom w/Lever | Mortise | — | Key in Knob/Lever | — | — | — |

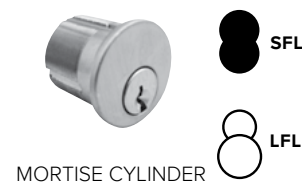

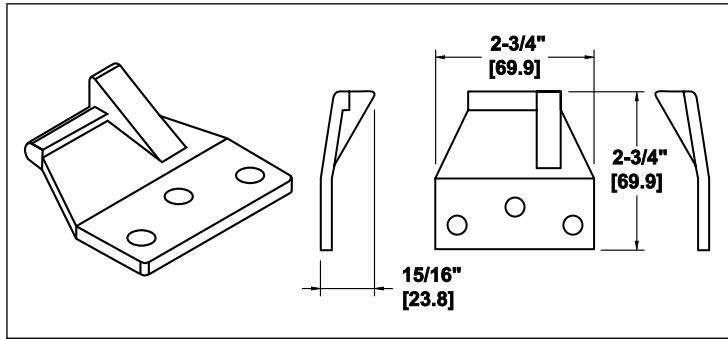

429019 DOUBLE DOOR STRIKE

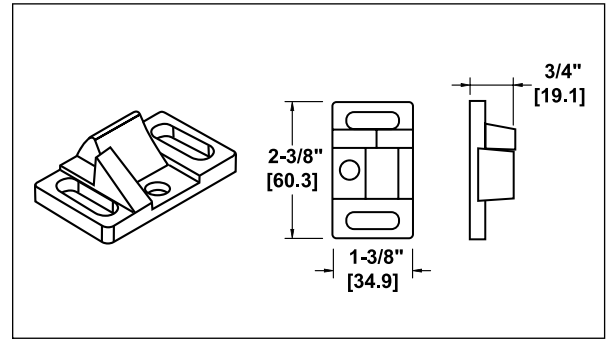

429005 SVR TOP STRIKE W/2 SHIMS PANIC AND FIRE

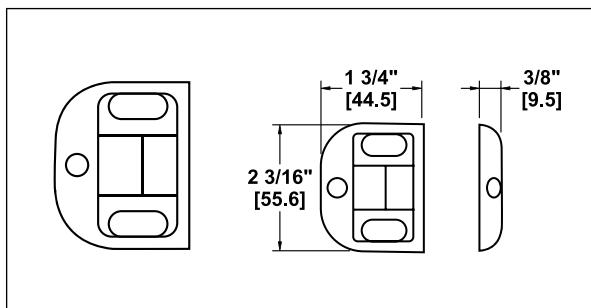

429006 SVR BOTTOM STRIKE
W/2 SHIMS PANIC AND FIRE

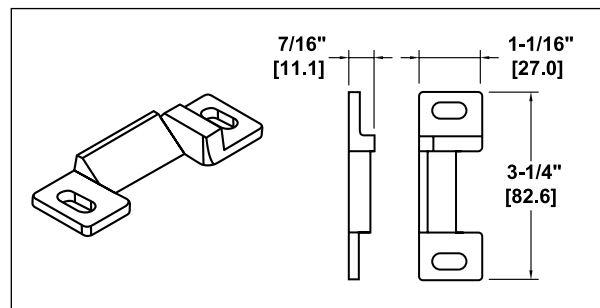

429036 RIM STD.
(2-3/4" BACKSET) FIRE & PANIC

Making Door Control Easy

PDQ offers a comprehensive line of door closers designed and manufactured to ensure superior performance and reliability. They offer the perfect combination of reliability, appearance, and durability. With a wide range of models and features, PDQ has a door closer for most applications.

Comprehensive Offering

7100 Institutional



Applications

7100 — The 7100 Series is PDQ's top of line heavy duty closer. It is designed for high use, high abuse institutional applications such as K-12, higher education and government buildings. 7100 Series closers are ideal for retrofit and new construction applications where strength and durability are required.

5100 Institutional



Applications

5100 — **5100** Series Door Closer is a heavy duty multi-feature closer that is perfect for high use, high abuse applications such as K-12, higher education, and government buildings. The 5100's compact design is ideal for interior door applications where it's distinctive lines harmonize with most decors.

5500 Commercial



Applications

5500 (Full cover) — Designed for maximum versatility, the 5500 Series sports a full cover and can be used for both commercial and institutional applications. This rugged workhorse is perfect for high traffic applications including federal/state buildings, assisted living facilities, hospitality, retail, religious, and medical buildings.

5300 Commercial



Applications

5300 (Slim cover) — The aesthetically pleasing 5300 Series comes standard with a slim line cover and offers the ideal combination of appearance, reliability, and durability for today's market. This rugged closer is perfect for high traffic applications such as healthcare, hospitality, government, assisted living, retail, and religious facilities.

3100 Light Commercial



Applications

3100 — Designed for medium-light duty applications, the 3100 Series is ideal for aluminum storefronts, interior offices, multi family, hospitality and many other applications. The 3100 combines dependable operation, low maintenance and stylish look.

7100 SERIES

Grade 1 Heavy Duty Closer

Typical Applications

- Assisted Living
- Higher Education
- High Use/High Abuse Situations
- K-12 Education
- Military and Government
- Multi-family
- Offices
- Public Buildings

Features

- Features a 1-1/2" (38mm) diameter hardened steel pinion
- Heavy duty, fully featured architectural style door control
- High strength cast iron body and forged steel arm assembly provide maximum durability and reliability in the most brutal environments
- Backcheck positioning valve feature provides a consistent backcheck snubbing range for regular, top jamb and parallel arm applications, preventing costly damage during forceful opening of the door

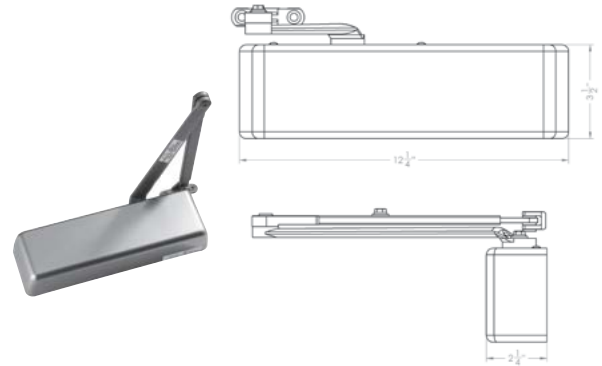

Specifications



| | |
|---|---|
| BODY: | • High Strength Cast Iron |
| ARMS: | • Forged steel main arm |
| ARM OPTIONS: | <ul style="list-style-type: none"> • PA – Parallel Arm • HO – Hold Open • DS/DSHO – Heavy Duty Parallel Stop • RA – Regular Arm • SCS/SCSHO – Spring Cushion Stop for DS/DSHO • TA/TAHO – Track Arm • EDA/EDAHO – Extra Duty Parallel Arm |
| PISTON: | • 1-1/2" diameter |
| ADJUSTMENT: | <ul style="list-style-type: none"> • Hydraulic controlled closing • Hydraulic backcheck standard • Backcheck positioning valve standard (starts backcheck snubbing sooner) • Optional delayed action (in addition to backcheck) |
| ADJUSTMENT VALVES: | • All Adjustment Valves are STAKED to prevent removal during adjustment. |
| SIZE: | • Adjustable BF through 6 |
| MOUNTING RETROFIT: | <ul style="list-style-type: none"> • Mounting hole pattern retrofits LCN™ 4040 • Tri-packed for regular, top jamb and parallel arm installations • Includes sex nuts/bolts and screws for wood/metal doors/frames • Self drilling self tapping screws standard • Separate limiting stop may be required for high abuse applications |
| COVER: | • Full plastic cover standard, optional full metal cover available |
| COLOR & ARCHITECTURAL FINISHES: | • 605 – Polished Brass, 625 – Polished Chrome, 689 – Aluminum, 693 – Black, 695 – Duro Bronze, 696 – Gold |
| WARRANTY: | • Twenty-five (25) year Limited Warranty |
| CERTIFICATIONS, LISTINGS, COMPLIANCES: | <ul style="list-style-type: none"> • UL listed for labeled swinging fire doors rated up to and including 3 hours • Certified to ANSI/BHMA A156.4 Grade 1 • Complies with ADA (Americans with Disabilities Act) and ICC/ANSI 117.1 for Accessible and Usable Buildings • TAA compliant. Country of origin: KR |

Spring Cushion Stops



**605
BRIGHT
BRASS**



**613E DARK OX-
IDIZED SATIN
BRONZE**



**630 SATIN
STAINLESS
STEEL**



693 BLACK

PDQ's SCS Series Spring Cushion Stop helps reduce wear and tear on the opening. As the door begins moving through back check to its maximum opening angle, the stop acts as a shock absorber, dampening the impact forces



7100 SERIES

LIST PRICE

Effective July 3, 2023

How to Order

| QUANTITY | SERIES | DELAYED ACTION | BACKCHECK | ARM TYPE | FINISH | ACCESSORIES |
|----------|--------|---|--|--|---|--|
| 10 | 71 | 01 – Non-Delayed Action 41 – Delayed Action (In Addition To Backcheck) | BC – Adjustable Hydraulic Backcheck | PA DS – Door Saver Arm DSHO – Door Saver Hold Open Arm EDA – Extra Duty Arm EDAHO – Extra Duty Arm Hold Open HO – Hold Open, Tri-Pack PA – Tri-Pack (standard) RA – Regular Arm SCS – Spring Cushion Stop SCSHO – Spring Cushion Stop Hold open TA – Track Arm TAHO – Track Arm Hold Open BLANK – Body Only | 689 605 – Polished Brass 625 – Polished Chrome 689 – Aluminum 693 – Black 695 – Duro Bronze 696 – Gold | — BP – Back Plate BS – Blade Stop Spacer DPPA – Parallel Arm Drop Plate DPTJ – Top Jamb Drop Plate FCM – Full Metal Cover specify hand NFB – Narrow Frame Bracket SDST – Self Drilling Self Tapping Screws |

PAGE 189

Closers

| PART | SIZE | DESCRIPTION | PAINTED 689/693 695/696 | PLATED 605/625 |
|-----------------------|------|---|-------------------------------|-------------------|
| 7101 BC PA | BF-6 | Closer, full cover, SNB (Tri-pack) | \$342.00 | \$497.00 |
| 7101 BC RA | BF-6 | Closer, full cover, Regular Arm, SNB | | |
| 7101 BC PA HO | BF-6 | Closer, hold open, full cover, SNB (Tri-pack) | \$425.00 | \$580.00 |
| 7101 BC DS | BF-6 | Closer, door saver, full cover, SNB (PA Only) | \$450.00 | \$605.00 |
| 7101 BC DSHO | BF-6 | Closer, door saver hold open, full cover, SNB (PA Only) | \$475.00 | \$630.00 |
| 7101 BC EDA | BF-6 | Closer, extra duty arm, full cover, SNB (PA Only) | \$450.00 | \$605.00 |
| 7101 BC EDA HO | BF-6 | Closer, extra duty arm hold open, full cover, SNB (PA Only) | \$475.00 | \$630.00 |
| 7101 BC SCS | BF-6 | Closer, door saver w/spring cushion stop, full cover, SNB (PA Only) | \$542.00 | \$697.00 |
| 7101 BC SCSHO | BF-6 | Closer, door saver hold open w/spring cushion stop, full cover, SNB (PA Only) | \$558.00 | \$713.00 |
| 7101 BC TA | BF-6 | Closer, track arm, full cover, (SNB for closer body only) | \$424.00 | - |
| 7101 BC TA HO | BF-6 | Closer, track arm hold open, full cover (SNB for closer body only) | \$445.00 | |
| 7101 BC | BF-6 | Closer, body only | \$262.00 | |

Options

| PART NO. | DESCRIPTION | CLOSER ADJUSTMENT |
|-------------|---|-------------------|
| 7141 | Delayed Action (when ordering, replace 7101 with 7141 in part number) | \$28.00 |

Accessories

| CODE | DESCRIPTION | LIST PRICE | |
|-------------|---|----------------------------|-------------------|
| | | PAINTED 689/693/695/696 | PLATED 605/625 |
| BS | Blade Stop Spacer (no finish) | \$80.00 | - |
| BP | Back Plate | | - |
| DPPA | Parallel Arm Drop Plate (PA mount) | | - |
| DPTJ | Top Jamb Drop Plate (TJ mount) | | - |
| BPTJ | Top Jamb Back Plate - Required to mount TJ on frame face less than 4" | | - |
| FCM | Full Metal Cover (specify hand) | \$120.00 | \$170.00 |
| NFB | Narrow Frame Bracket for DS/DSHO/EDS/EDAHO Arms, PA & BS Brackets | \$48.00 | - |
| SDST | Self Drilling Self Tapping Screws | \$17.00 | \$35.00 |

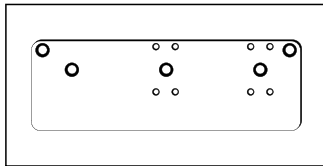

BP - BACK PLATE

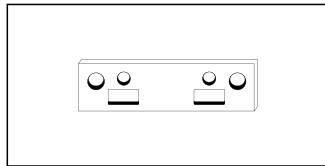

BS - BLADE STOP SPACER

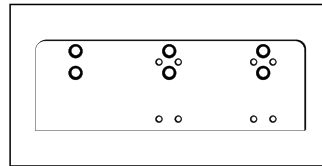

DPTJ - TOP JAMB DROP PLATE

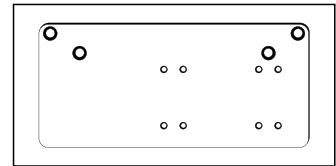

DPPA - PARALLEL ARM DROP PLATE

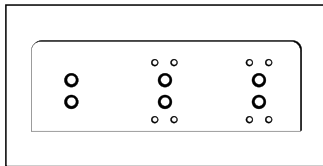

BPTJ - TOP JAMB BACK PLATE

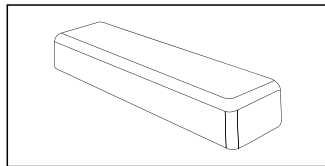

FCM - FULL METAL COVER

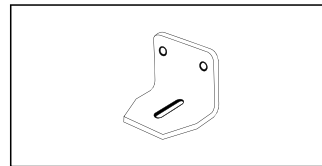

NFB - NARROW FRAME BRACKET

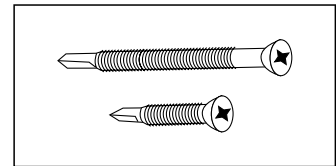

SDST - SELF DRILLING SELF TAPPING SCREWS

Arms

| CODE | DESCRIPTION | PART NO. (SPECIFY FINISH) | LIST PRICE | |
|--------------|--|------------------------------|----------------------------|----------------|
| | | | PAINTED 689/693/695/696 | PLATED 605/625 |
| RA | REGULAR ARM - Can be mounted REG/TJ/PA (requires PA bracket) | 719003 | \$96.00 | \$171.00 |
| EDA | EXTRA DUTY ARM - PA application only (bumper eliminated) | 719005 | \$145.00 | \$220.00 |
| DS | DOOR SAVER ARM (Limiting Stop) - PA application only | 719005 | | |
| DSHO | DOOR SAVER HOLD OPEN ARM (limiting stop) PA application only | 719016 | \$165.00 | \$240.00 |
| HO | HOLD OPEN ARM - can be mounted REG/TJ/PA (requires PA bracket) | 719002 | \$122.00 | \$197.00 |
| EDAHO | EXTRA DUTY ARM HOLD OPEN - PA application only (bumper eliminated) | 719016 | \$165.00 | \$240.00 |
| TA | TRACK ARM ASSEMBLY - (Includes track, arm and screws) | 719025 | \$122.00 | - |
| TAHO | TRACK ARM HOLD OPEN | 719027 | \$140.00 | - |
| PA | PARALLEL ARM BRACKET - HO and NHO | 719001 | \$22.00 | \$97.00 |
| ELR | Extended arm half to be used on Top Jamb mounts with reveals from 3" to 6" | 719028 | \$55.00 | - |

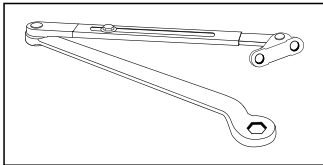

RA - REGULAR ARM

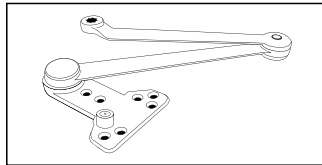

DS - Door Saver (Limiting Stop) Arm

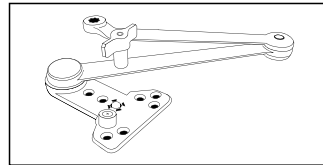

DSHO - DOOR SAVER (LIMITING STOP) HOLD OPEN ARM

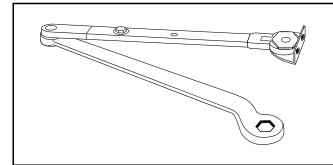

HO - Hold Open Arm

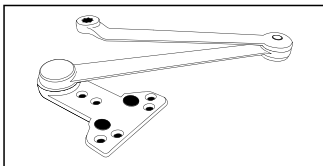

EDA - EXTRA DUTY ARM

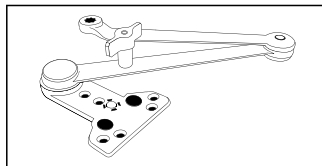

EDAHO - EXTRA DUTY ARM HOLD OPEN

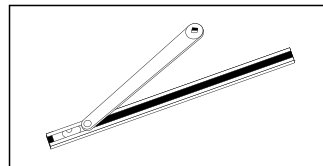

TA - TRACK ARM ASSEMBLY

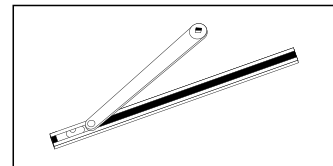

TAHO - TRACK ARM HOLD OPEN

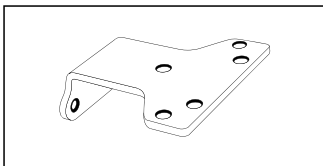

PA - PARALLEL ARM BRACKET

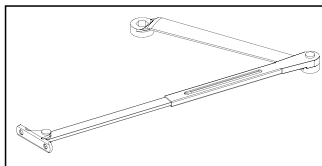

ELR - EXTENDED ARM

Covers

| CODE | DESCRIPTION | PART NO. (SPECIFY FINISH) | LIST PRICE | |
|------------|--|------------------------------|----------------------------|-------------------|
| | | | PAINTED 689/693/695/696 | PLATED 605/625 |
| FC | FULL PLASTIC COVER | 719006 | \$45.00 | \$90.00 |
| FCM | FULL METAL COVER - Optional (specify hand) | 719006ST | \$120.00 | \$170.00 |

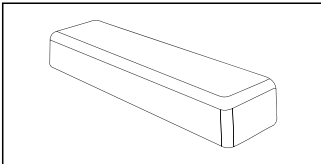

FC - FULL PLASTIC COVER

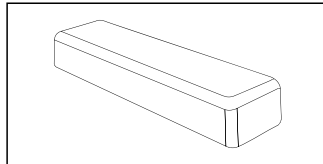

FCM - FULL METAL COVER

Mounting Plates

| CODE | DESCRIPTION | PART NO. (SPECIFY FINISH) | LIST PRICE |
|-------------|---|------------------------------|----------------------------|
| | | | PAINTED 689/693/695/696 |
| BP | BACK PLATE - For regular arm applications to clear mortised stop/holder | 719008 | \$80.00 |
| BPTJ | TOP JAMB BACK PLATE - Required to mount TJ on frame face less than 4" | 719024 | |
| DPTJ | TOP JAMB DROP PLATE - Required to mount TJ with limited ceiling clearance or to clear surface applied stop/holder | 719023 | |
| DPPA | PARALLEL ARM DROP PLATE - Required for parallel arm mount with limited top door rail | 719018 | \$48.00 |
| BS* | BLADE STOP SPACER - Shims all PA brackets to clear 1/2" blade stop (no finish) | 999026 | |
| NFB | NARROW FRAME BRACKET - For DS/DSHO/EDS/EDAHO arms, PA and BS brackets for added reinforcement (no finish) | 999011 | |

*Note: When using a Blade Stop Spacer in a narrow frame application you must use the (NFB) Narrow Frame Bracket for proper support.

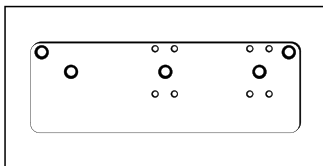

BP - BACK PLATE

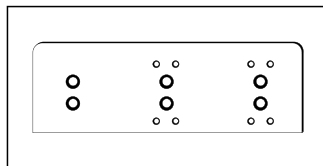

BPTJ - TOP JAMB BACK PLATE

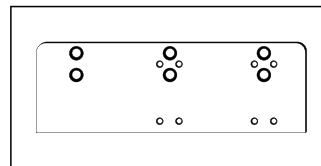

DPTJ - TOP JAMB DROP PLATE

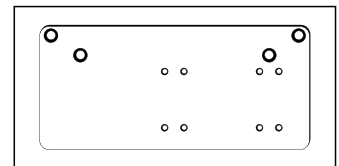

DPPA - PARALLEL ARM DROP PLATE

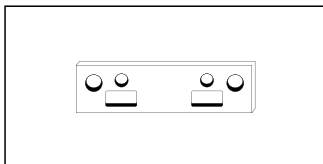

BS - BLADE STOP SPACER

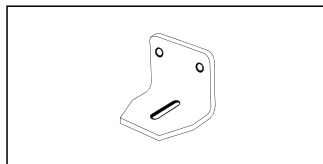

NFB - NARROW FRAME BRACKET

7100 SERIES

LIST PRICE

Effective July 3, 2023

Fasteners

| CODE | DESCRIPTION | PART NO. (SPECIFY FINISH) | LIST PRICE | |
|------|---|------------------------------|----------------------------|-------------------|
| | | | PAINTED 689/693/695/696 | PLATED 605/625 |
| SDST | SELF DRILLING SELF TAPPING SCREWS | 719007 | \$17.00 | \$35.00 |
| SP | SCREW PACK | 719020 | | |
| SNB | SEX NUTS AND BOLTS -For through bolting on unreinforced hollow core, composite or labeled fire doors 1-3/4" only. (set of 4 each) | 999004 | | |
| TSP | Tamper resistant screw pack | *719042 | \$90.00 | |

*No finish

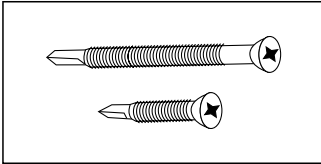

SDST - SELF DRILLING SELF TAPPING SCREWS

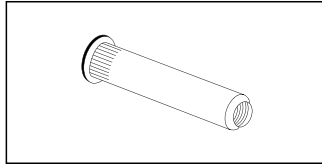

SNB - SEX NUTS AND BOLTS

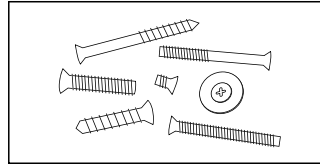

SP - SCREW PACK

Parts

| CODE | DESCRIPTION | PART NO. (SPECIFY FINISH) | LIST PRICE | |
|--------|---|------------------------------|-------------------------------|-------------------|
| | | | PAINTED 689/693 695/696 | PLATED 605/625 |
| DSBS | DOOR SAVER BUMPER STOP - (no finish) Used on DS, DSHO, PS arms | 999010 | \$22.00 | |
| SPBL | PLASTIC SPACER BLOCK - For DS/DSHO/EDA/EDAHO and PA soffit brackets (no finish) | 999031 | \$10.00 | |
| HO KIT | TA ARM TO MAKE TAHO (no finish) | 999030 | \$35.00 | |
| SCS | SPRING CUSHION STOP* - USE with DS/DSHO for 3'0" doors (specify finish), for PA mount arms only | 999032 | \$150.00 | |
| SCS | SPRING CUSHION STOP* - For DS/DSHO for 4'0" doors, (specify finish), for PA mount arms only | 999033 | | |

* Spring Cushion Stop requires purchase of a PDQ DS or DSHO arm.

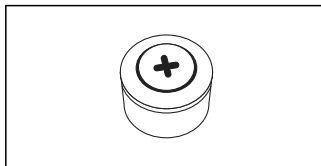

DSBS - DOOR SAVER BUMPER STOP

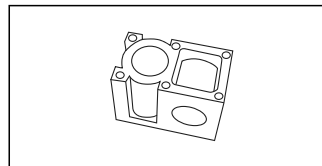

SPBL - PLASTIC SPACER BLOCK

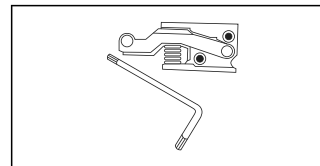

HO KIT - TA ARM TO MAKE TAHO

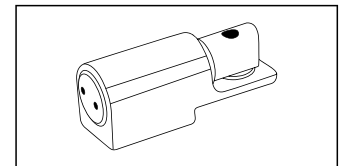

SCS - SPRING CUSHION STOP

Spring Cushion Stop (SCS) Finish Match to Closers

| SCS FINISH | CLOSER FINISH |
|------------|---------------|
| 605 (PVD) | 605/696 |
| 613E (PVD) | 695 |
| 630 | 625/626/689 |
| 693 | 693 |

5100 SERIES

Grade 1 Institutional Closer

Typical Applications

- Aluminum Storefronts
- Assisted Living
- Government Facilities
- Higher Education
- Hospitality
- Houses of Worship
- Interior Office Doors
- Multi-family
- Offices
- Retail

Features

- Features a 1-1/2" (38 mm) diameter hardened steel pinion
- Fully featured architectural style door control
- Full cover and flat design arm assembly provide both durability and aesthetically pleasing appearance in commercial and institutional applications
- The closer is ideally suited for installation on wood or metal doors and frames.
- The units are non-handed and fully adjustable from size one through six for maximum flexibility.
- The standard tri-pack feature provides versatility to permit regular, top-jamb and parallel arm installations.
- A range of sprayed and architectural finishes are available to compliment any décor.
- Maximum 4" reveal for Top Jamb.

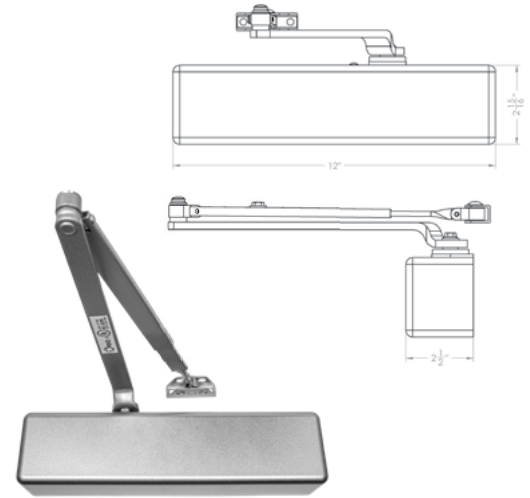

Specifications



| | |
|---|---|
| BODY: | • High Strength Aluminum Alloy Body |
| ARM OPTIONS: | <ul style="list-style-type: none"> • PA – Parallel Arm • HO – Hold Open • DS/DSHO – Heavy Duty Parallel Arm Stop • RA – Regular Arm • SCS/SCSHO – Heavy Duty Parallel Arm Cushion Stop • TA/TAHO – Track Arm • EDA/EDAHO – Extra Duty Parallel Arm • PS – Pivot Stop Arm* |
| PINION: | • Hardened steel, 1-1/2" diameter |
| ADJUSTMENT: | • Hydraulic controlled closing • Separate hydraulic backcheck standard • Optional delayed action (in addition to backcheck) |
| SIZE: | • Adjustable 1 through 6 |
| MOUNTING: | <ul style="list-style-type: none"> • Tri-packed for regular, top jamb and parallel arm installations • Includes sex nuts/bolts and screws for wood/metal doors/frames • Self drilling, self tapping screws standard • Separate limiting stop may be required for high abuse application |
| COVER: | • Full plastic cover standard, optional full metal cover available |
| COLOR & ARCHITECTURAL FINISHES: | • 605 – Polished Brass, 626 – Satin Chrome, 689 – Aluminum, 693 – Black, 695 – Duro Bronze, 696 – Gold |
| WARRANTY: | • Twenty-five (25) year Limited Warranty |
| CERTIFICATIONS, LISTINGS, COMPLIANCES: | <ul style="list-style-type: none"> • UL listed for labeled swinging fire doors rated up to and including 3 hours • Certified to ANSI/BHMA A156.4 Grade 1 • TAA compliant. Country of origin: KR |

5100 SERIES

LIST PRICE

Effective July 3, 2023

How to Order

5100 SERIES
DOOR CLOSERS

| QUANTITY | SERIES | DELAYED ACTION | BACKCHECK | ARM TYPE | FINISH | ACCESSORIES |
|---|--------|---|-------------------------------------|---|--|--|
| 10 | 51 | 01 | BC | PA | 689 | — |
| NOTES 1 - Hold Open (HO) option not permitted for use on labeled fire doors. 2 - Separate limiting stop may be required. | | 01 – Non-Delayed Action 41 – Delayed Action (In Addition To Backcheck) | BC – Adjustable Hydraulic Backcheck | DS – Door Saver Arm DSHO – Door Saver Hold Open Arm EDA – Extra Duty Arm EDA HO – Extra Duty Arm Hold Open HO – Hold Open, Tri-Pack PA – Tri-Pack (standard) RA – Regular Arm SCS – Spring Cushion Stop SCSHO – Spring Cushion Stop Hold open TA – Track Arm TAHO – Track Arm Hold Open PS – Pivot Stop Arm BLANK – Body Only | 605 – Polished Brass 626 – Satin Chrome 689 – Aluminum 693 – Black 695 – Duro Bronze 696 – Gold | BP – Back Plate BS – Blade Stop Spacer DPPA – Parallel Arm Drop Plate DPTJ – Top Jamb Drop Plate FCM – Full Metal Cover specify hand NFB – Narrow Frame Bracket SDST – Self Drilling Self Tapping Screws |
| | | | | | | PAGE 195 |

Closers

| PART | DESCRIPTION | PAINTED 689/693 695/696 | PLATED 605/626 |
|----------------|--|-------------------------------|-------------------|
| 5101 BC PA | Closer, 1-6, full cover, SNB (Tri-pack) | \$262.00 | \$362.00 |
| 5101 BC RA | Closer, 1-6, full cover, regular arm, SNB | | |
| 5101 BC PA HO | Closer, 1-6, hold open, full cover, SNB (Tri-pack) | \$342.00 | \$442.00 |
| 5101 BC DS | Closer, 1-6, door saver, full cover, SNB (PA only) | \$367.00 | \$467.00 |
| 5101 BC DSHO | Closer, 1-6, door saver hold open, full cover, SNB (PA only) | \$397.00 | \$497.00 |
| 5101 BC EDA | Closer, 1-6, extra duty arm, full cover, SNB (PA only) | \$367.00 | \$467.00 |
| 5101 BC EDA HO | Closer, 1-6, extra duty arm hold open, full cover, SNB (PA only) | \$397.00 | \$497.00 |
| 5101 BC SCS | Closer, 1-6, door saver w/spring cushion stop, full cover, SNB (PA only) | \$462.00 | \$562.00 |
| 5101 BC SCSHO | Closer, 1-6, door saver hold open w/spring cushion stop, full cover, SNB (PA only) | \$467.00 | \$567.00 |
| 5101 BC TA | Closer, 1-6, track arm, full cover (SNB for closer body only) | \$317.00 | - |
| 5101 BC TAHO | Closer, 1-6, track arm hold open, full cover (SNB for closer body only) | \$342.00 | - |
| 5101 BC PS | Closer, 1-6, pivot stop, full cover (SNB for closer body only) | \$412.00 | - |
| 5101 BC | Closer, 1-6, body only | \$200.00 | - |

Options

| PART NO. | DESCRIPTION | CLOSER ADJUSTMENT |
|----------|---|-------------------|
| 5141 | Delayed Action (when ordering, replace 5101 with 5141 in part number) | \$28.00 |

Accessories

| CODE | DESCRIPTION | LIST PRICE | |
|------|-------------------------------------|----------------------------|-------------------|
| | | PAINTED 689/693/695/696 | PLATED 605/625 |
| BS | Blade Stop Spacer (no finish) | \$80.00 | - |
| BP | Back Plate | | |
| DPPA | Parallel Arm Drop Plate (5500 only) | | |
| DPTJ | Top Jamb Drop Plate | | |
| NFB | Parallel Arm NHO Bracket | \$48.00 | |
| SDST | Self Drilling Self Tapping Screws | \$17.00 | \$35.00 |

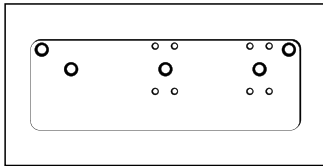

BP - BACK PLATE

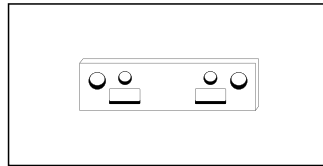

BS - BLADE STOP SPACER

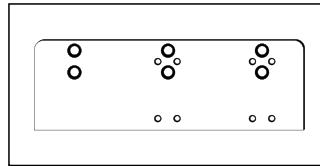

DPTJ - TOP JAMB DROP PLATE

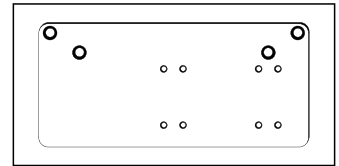

DPPA - PARALLEL ARM DROP PLATE

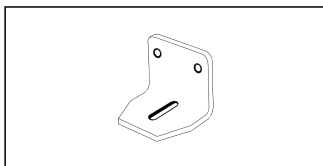

NFB - NARROW FRAME BRACKET

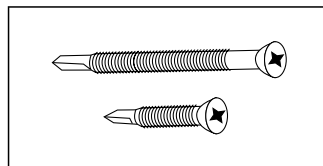

SDST - SELF DRILLING SELF TAPPING SCREWS

Spring Cushion Stops



605
BRIGHT
BRASS



613E DARK OX-
IDIZED SATIN
BRONZE



630 SATIN
STAINLESS
STEEL



693 BLACK

PDQ's SCS Series Spring Cushion Stop helps reduce wear and tear on the opening. As the door begins moving through back check to its maximum opening angle, the stop acts as a shock absorber, dampening the impact forces

Arms

| CODE | DESCRIPTION | PART NO. (SPECIFY FINISH) | LIST PRICE | |
|--------------|--|------------------------------|----------------------------|----------------|
| | | | PAINTED 689/693/695/696 | PLATED 605/625 |
| RA | REGULAR ARM - Can be mounted REG/TJ/PA (requires PA bracket) | 999003 | \$80.00 | \$130.00 |
| EDA | EXTRA DUTY ARM - PA application only (bumper eliminated) | 999005 | \$160.00 | \$210.00 |
| DS | DOOR SAVER ARM (Limiting Stop) - PA application only | 999005 | | |
| DSHO | DOOR SAVER HOLD OPEN ARM (limiting stop) PA application only | 999016 | \$194.00 | \$244.00 |
| HO | HOLD OPEN ARM - can be mounted REG/TJ/PA (requires PA bracket) | 999002 | \$122.00 | \$172.00 |
| EDAHO | EXTRA DUTY ARM HOLD OPEN - PA application only (bumper eliminated) | 999016 | \$194.00 | \$244.00 |
| TA | TRACK ARM ASSEMBLY - (Includes track, arm and screws) | 999025 | \$122.00 | |
| TAHO | TRACK ARM HOLD OPEN | 999027 | \$145.00 | |
| PA | PARALLEL ARM BRACKET - NON HOLD OPEN applications | 999001 | \$22.00 | \$72.00 |
| PAHO | PARALLEL ARM BRACKET - HOLD OPEN applications | 999022 | \$33.00 | |
| PS | PIVOT STOP ARM - Regular and Top Jamb Only | 999018 | \$184.00 | |

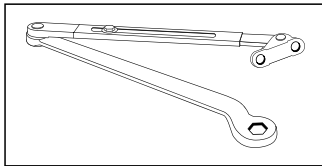

RA - REGULAR ARM

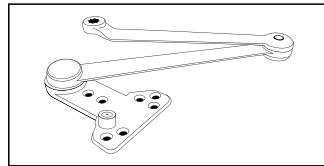

DS - DOOR SAVER (LIMITING STOP) ARM

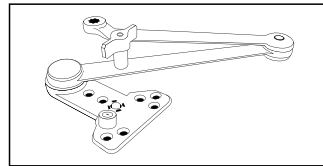

DSHO - DOOR SAVER (LIMITING STOP) HOLD OPEN ARM

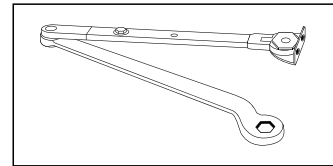

HO - HOLD OPEN ARM

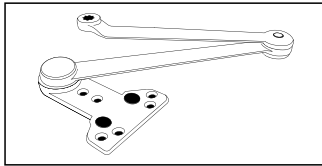

EDA - EXTRA DUTY ARM

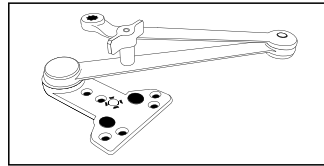

EDAHO - EXTRA DUTY ARM HOLD OPEN

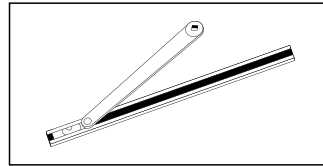

TA - TRACK ARM ASSEMBLY

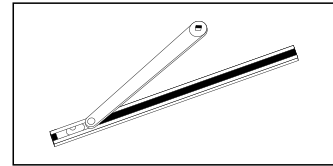

TAHO - TRACK ARM HOLD OPEN

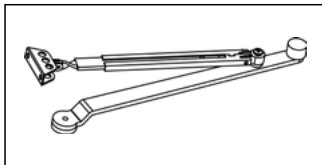

PS - PIVOT STOP ARM

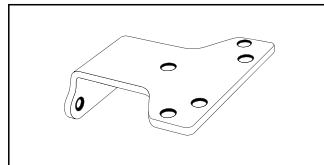

PA - PARALLEL ARM BRACKET

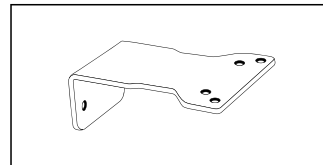

PAHO - PARALLEL ARM HO BRACKET

Covers

| CODE | DESCRIPTION | PART NO. (SPECIFY FINISH) | LIST PRICE | |
|------------|--------------------|------------------------------|----------------------------|-------------------|
| | | | PAINTED 689/693/695/696 | PLATED 605/625 |
| FC | FULL PLASTIC COVER | 559006 | \$45.00 | \$90.00 |
| FMC | FULL METAL COVER | 519006ST | \$100.00 | - |

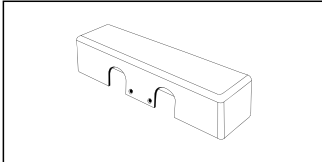

FC - FULL PLASTIC COVER-5500
(STANDARD)

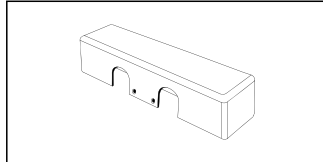

FMC - FULL METAL COVER
(OPTIONAL)

Mounting Plates

| CODE | DESCRIPTION | PART NO. (SPECIFY FINISH) | LIST PRICE |
|-------------|---|------------------------------|----------------------------|
| | | | PAINTED 689/693/695/696 |
| BP | BACK PLATE - For regular arm applications to clear mortised stop/holder | 519008 | \$80.00 |
| DPTJ | TOP JAMB DROP PLATE - Required to mount TJ with limited ceiling clearance or to clear surface applied stop/holder | 519023 | |
| DPPA | PARALLEL ARM DROP PLATE - Required for parallel arm mount with limited top door rail | 519018 | |
| BS* | BLADE STOP SPACER - Shims all PA brackets to clear 1/2" blade stop (no finish) | 999026 | |
| NFB | NARROW FRAME BRACKET - For DS/DSHO/EDS/EDAHO arms, PA and BS brackets for added reinforcement (no finish) | 999011 | \$48.00 |

*Note: When using a Blade Stop Spacer in a narrow frame application you must use the (NFB) Narrow Frame Bracket for proper support.

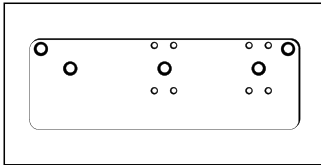

BP - BACK PLATE

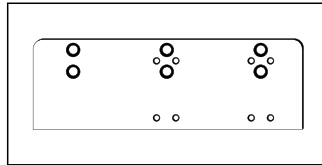

DPTJ - TOP JAMB DROP PLATE

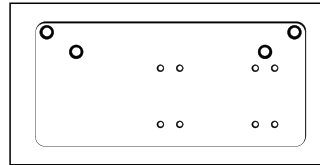

DPPA - PARALLEL ARM DROP
PLATE

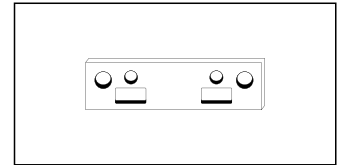

BS - BLADE STOP SPACER

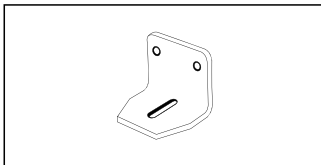

NFB - NARROW FRAME BRACKET

5100 SERIES

LIST PRICE

Effective July 3, 2023

5100 SERIES
DOOR CLOSERS

Fasteners

| CODE | DESCRIPTION | PART NO. (SPECIFY FINISH) | LIST PRICE | |
|------|---|------------------------------|----------------------------|-------------------|
| | | | PAINTED 689/693/695/696 | PLATED 605/625 |
| SDST | SELF DRILLING SELF TAPPING SCREWS | 999007 | \$17.00 | \$35.00 |
| SP | SCREW PACK | 999020 | | |
| SNB | SEX NUTS AND BOLTS -For through bolting on unreinforced hollow core, composite or labeled fire doors 1-3/4" only. (set of 4 each) | 999004 | | |

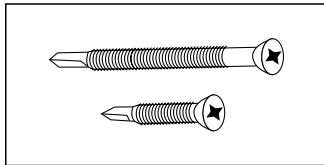

SDST - SELF DRILLING SELF TAPPING SCREWS

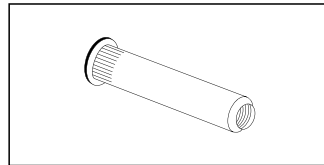

SNB - SEX NUTS AND BOLTS

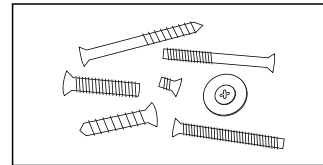

SP - SCREW PACK

Parts

| CODE | DESCRIPTION | PART NO. (SPECIFY FINISH) | LIST PRICE | |
|--------|---|------------------------------|-------------------------------|-------------------|
| | | | PAINTED 689/693 695/696 | PLATED 605/625 |
| DSBS | DOOR SAVER BUMPER STOP - (no finish) Used on DS, DSHO, PS Arms | 999010 | \$22.00 | |
| SPBL | PLASTIC SPACER BLOCK - For DS/DSHO/EDA/EDAHO and PA soffit brackets (no finish) | 999031 | \$10.00 | |
| HO KIT | TA ARM TO MAKE TAHO (no finish) | 999030 | \$35.00 | |
| SCS | SPRING CUSHION STOP* - USE with DS/DSHO for 3'0" doors (specify finish), for PA mount arms only | 999032 | \$150.00 | |
| SCS | SPRING CUSHION STOP* - For DS/DSHO for 4'0" doors, (specify finish), for PA mount arms only | 999033 | | |

* Spring Cushion Stop requires purchase of a PDQ DS or DSHO arm.

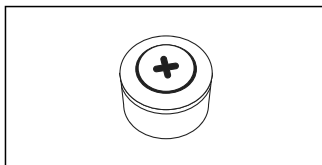

DSBS - DOOR SAVER BUMPER STOP

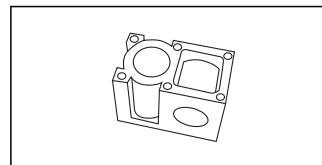

SPBL - PLASTIC SPACER BLOCK

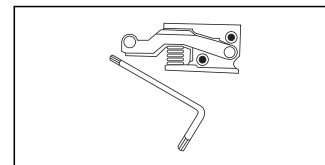

HO KIT - TA ARM TO MAKE TAHO

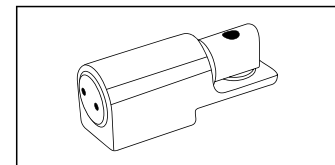

SCS - SPRING CUSHION STOP

Spring Cushion Stop (SCS) Finish Match to Closers

| SCS FINISH | CLOSER FINISH |
|------------|---------------|
| 605 (PVD) | 605/696 |
| 613E (PVD) | 695 |
| 630 | 625/626/689 |
| 693 | 693 |

5300 Slim Cover 5500 Full Cover SERIES

Grade 1 Commercial Closer

Typical Applications

- Assisted Living
- Exterior Doors in Heavy Draft/Wind Conditions
- Government Facilities
- Healthcare
- Higher Education
- Hospitality
- Houses of Worship
- Industrial
- K-12 Education
- Offices
- Retail

Features

- Heavy duty, fully featured architectural style door control
- Available with modern streamline cover or full sized cover
- Compact appearance and features meet the demands of institutional and commercial applications
- The standard tri-pack, full range spring adjustment and common 12" x 3/4" mounting hole pattern make the 5300/5500 ideally suited for stocking distributors and retrofit applications
- Adjustable hydraulic backcheck prevents damage for uncontrolled door opening
- Perfect solution for a variety of applications requiring streamline architectural grade door controls
- Maximum 4" reveal for Top Jamb.

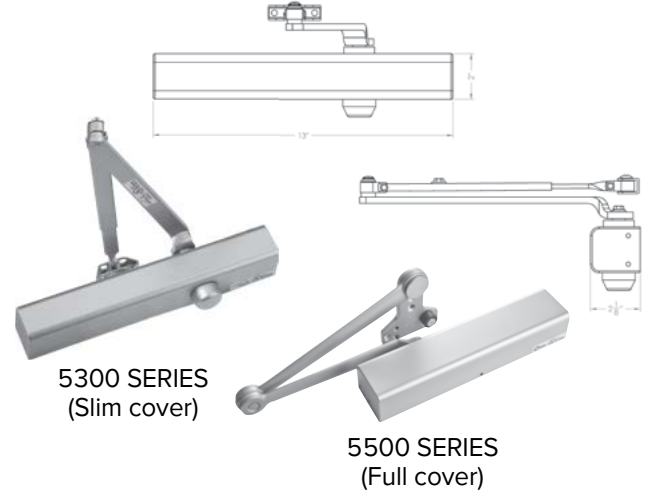

5300 SERIES
(Slim cover)

5500 SERIES
(Full cover)

Specifications



| | |
|---|---|
| BODY: | • Cast High Strength Aluminum Alloy Body |
| ARM OPTIONS: | <ul style="list-style-type: none"> • PA – Parallel Arm • HO – Hold Open • DS/DSHO – Heavy Duty Parallel Arm Stop • RA – Regular Arm • SCS/SCSHO – Heavy Duty Parallel Arm Cushion Stop • TA/TAHO – Track Arm • EDA/EDAHO – Extra Duty Parallel Arm • PS – Pivot Stop Arm* |
| ADJUSTMENT: | <ul style="list-style-type: none"> • Hydraulic controlled closing • Separate hydraulic backcheck standard • Optional adjustable delayed action (In addition to backcheck) |
| RETROFIT: | • Common 12" x 3/4" mounting hole pattern retrofits Norton 8300/8500* and Yale 3300/3500 |
| SIZE: | • Adjustable • BF through 6 |
| MOUNTING: | <ul style="list-style-type: none"> • Includes sex nuts/bolts and screws for wood/metal doors/frames • Tri-packed for regular, top jamb and parallel arm installations • Separate limiting stop may be required for high abuse applications • Self drilling, self tapping screws standard |
| COVER: | • 5300 Series - Streamline plastic cover (non-handed) 5500 Series - Full plastic cover standard (field reversible) |
| COLOR & ARCHITECTURAL FINISHES: | • 605 – Polished Brass, 625 – Polished Chrome, 689 – Aluminum, 693 – Black, 695 – Duro Bronze, 696 – Gold |
| WARRANTY: | • Twenty-five (25) year Limited Warranty |
| CERTIFICATIONS, LISTINGS, COMPLIANCES: | <ul style="list-style-type: none"> • UL listed for labeled swinging fire doors rated up to and including 3 hours • Certified to ANSI/BHMA A156.4 Grade 1 • Complies with ADA (Americans with Disabilities Act) and ICC/ANSI 117.1 for Accessible and Usable Buildings • TAA compliant. Country of origin: KR |

5300/5500 SERIES

LIST PRICE

Effective July 3, 2023

How to Order

| QUANTITY | SERIES | DELAYED ACTION | BACKCHECK | ARM TYPE | FINISH | ACCESSORIES |
|----------|------------------------------------|---|-------------------------------------|--|---|---|
| 10 | 53 | 01 | BC | PA | 689 | — |
| | 53 – Slim Cover 55 – Full Cover | 01 – Non-Delayed Action 41 – Delayed Action (In Addition to Backcheck) | BC – Adjustable Hydraulic Backcheck | DS – Door Saver Arm DSHO – Door Saver Hold Open Arm EDA – Extra Duty Arm EDAHO – Extra Duty Arm Hold Open HO – Hold Open, Tri-Pack PA – Tri-Pack (standard) RA – Regular Arm SCS – Spring Cushion Stop SCSHO – Spring Cushion Stop Hold open TA – Track Arm TAHO – Track Arm Hold Open PS – Pivot Stop Arm BLANK – Body Only | 605 – Polished Brass 625 – Polished Chrome 689 – Aluminum 693 – Black 695 – Duro Bronze 696 – Gold | BP – Back Plate BS – Blade Stop Spacer DPPA – Parallel Arm Drop Plate DPTJ – Top Jamb Drop Plate NFB – Narrow Frame Bracket |
| | | | | | | PAGE 202 |

5300/5500 SERIES DOOR CLOSERS

5300/5500 SERIES

LIST PRICE

Effective July 3, 2023

Closers

| PART | DESCRIPTION | PAINTED 689/693 695/696 | PLATED 605/625 |
|---------------|---|-------------------------------|-------------------|
| 5300 SERIES | | | |
| 5301 BC PA | Closer, BF-6, streamline cover, SNB (Tri-pack) | \$240.00 | \$340.00 |
| 5301 BC RA | Closer, BF-6, regular arm, streamline cover, SNB | | |
| 5301 BC PA HO | Closer, BF-6, hold open, streamline cover, SNB (Tri-pack) | \$320.00 | \$420.00 |
| 5301 BC DS | Closer, BF-6, door saver, streamline cover, SNB (PA only) | \$345.00 | \$445.00 |
| 5301 BC DSHO | Closer, BF-6, door saver hold open, streamline cover, SNB (PA only) | \$375.00 | \$475.00 |
| 5301 BC EDA | Closer, BF-6, extra duty arm, streamline cover, SNB (PA only) | \$345.00 | \$445.00 |
| 5301 BC EDAHO | Closer, BF-6, extra duty hold open, streamline cover, SNB (PA only) | \$375.00 | \$475.00 |
| 5301 BC SCS | Closer, BF-6, door saver w/spring cushion stop, streamline cover, SNB (PA only) | \$440.00 | \$540.00 |
| 5301 BC SCSHO | Closer, BF-6, door saver hold open w/spring cushion stop, streamline cover, SNB (PA only) | \$445.00 | \$545.00 |
| 5301 BC TA | Closer, BF-6, track arm, streamline cover (SNB for closer body only) | \$295.00 | |
| 5301 BC TAHO | Closer, BF-6, track arm hold open, streamline cover (SNB for closer body only) | \$320.00 | |
| 5301 BC PS | Closer, BF-6, pivot stop, streamline cover (SNB for closer body only) | \$390.00 | |
| 5301 BC | Closer, BF-6, body only | \$200.00 | |
| 5500 SERIES | | | |
| 5501 BC PA | Closer, BF-6, full cover, SNB (Tri-pack) | \$240.00 | \$340.00 |
| 5501 BC RA | Closer, BF-6, regular arm, streamline cover, SNB | | |
| 5501 BC PA HO | Closer, BF-6, hold open, full cover, SNB (Tri-pack) | \$320.00 | \$420.00 |
| 5501 BC DS | Closer, BF-6, door saver, full cover, SNB (PA only) | \$345.00 | \$445.00 |
| 5501 BC DSHO | Closer, BF-6, door saver hold open, full cover, SNB (PA only) | \$375.00 | \$475.00 |
| 5501 BC EDA | Closer, BF-6, extra duty arm, full cover, SNB (PA only) | \$345.00 | \$445.00 |
| 5501 BC EDAHO | Closer, BF-6, extra duty arm hold open, full cover, SNB (PA only) | \$375.00 | \$475.00 |
| 5501 BC SCS | Closer, BF-6, door saver w/spring cushion stop, full cover, SNB (PA only) | \$440.00 | \$540.00 |
| 5501 BC SCSHO | Closer, BF-6, door saver hold open w/spring cushion stop, full cover, SNB (PA only) | \$445.00 | \$545.00 |
| 5501 BC TA | Closer, BF-6, track arm, streamline cover (SNB for closer body only) | \$295.00 | |
| 5501 BC TAHO | Closer, BF-6, rack arm hold open, streamline cover (SNB for closer body only) | \$320.00 | |
| 5501 BC PS | Closer, BF-6, pivot stop, full cover (SNB for closer body only) | \$390.00 | |
| 5501 BC | Closer, BF-6, body only | \$200.00 | |

5300/5500
SERIES
DOOR CLOSERS

Options

| CODE | DESCRIPTION | CLOSER ADJUSTMENT |
|------|---|----------------------|
| 5341 | Delayed Action 5300 Series (when ordering, replace 5301 with 5341 in part number) | \$28.00 |
| 5541 | Delayed Action 5500 Series (when ordering, replace 5501 with 5541 in part number) | |

Accessories

| CODE | DESCRIPTION | LIST PRICE | |
|-------------|---|----------------------------|-------------------|
| | | PAINTED 689/693/695/696 | PLATED 605/625 |
| BS | Blade Stop Spacer (no finish) | \$80.00 | - |
| BP | Back Plate | | - |
| DPPA | Parallel Arm Drop Plate (5500 only) | | - |
| DPTJ | Top Jamb Drop Plate (and PA Drop for 5300 only) | | - |
| NFB | Parallel Arm NHO Bracket | \$48.00 | - |
| SDST | Self Drilling Self Tapping Screws | \$17.00 | \$35.00 |

5300/5500 SERIES DOOR CLOSERS

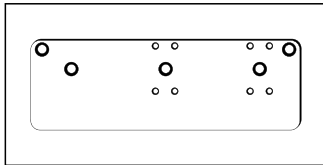

BP - BACK PLATE

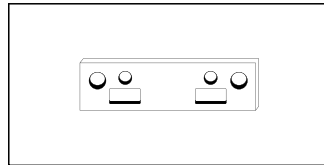

BS - BLADE STOP SPACER

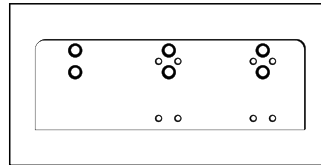

DPTJ - TOP JAMB DROP PLATE

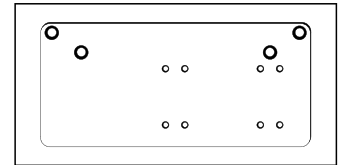

DPPA - PARALLEL ARM DROP PLATE

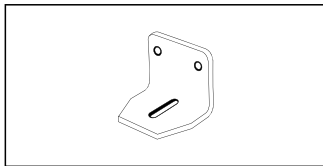

NFB - NARROW FRAME BRACKET

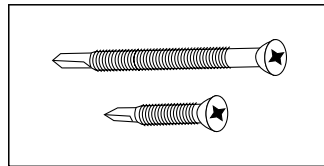

SDST - SELF DRILLING SELF TAPPING SCREWS

Spring Cushion Stops



605 BRIGHT BRASS



613E DARK OXIDIZED SATIN BRONZE



630 SATIN STAINLESS STEEL



693 BLACK

PDQ's SCS Series Spring Cushion Stop helps reduce wear and tear on the opening. As the door begins moving through back check to its maximum opening angle, the stop acts as a shock absorber, dampening the impact forces — See page 223

Arms

| CODE | DESCRIPTION | PART NO. (SPECIFY FINISH) | LIST PRICE | |
|-------|--|------------------------------|----------------------------|----------------|
| | | | PAINTED 689/693/695/696 | PLATED 605/625 |
| RA | REGULAR ARM - Can be mounted REG/TJ/PA (requires PA bracket) | 999003 | \$80.00 | \$130.00 |
| EDA | EXTRA DUTY ARM - PA application only (bumper eliminated) | 999005 | \$160.00 | \$210.00 |
| DS | DOOR SAVER ARM (Limiting Stop) - PA application only | 999005 | | |
| DSHO | DOOR SAVER HOLD OPEN ARM (limiting stop) PA application only | 999016 | \$194.00 | \$244.00 |
| EDAHO | EXTRA DUTY ARM HOLD OPEN - PA application only (bumper eliminated) | 999016 | \$122.00 | \$172.00 |
| HO | HOLD OPEN ARM - can be mounted REG/TJ/PA (requires PA bracket) | 999002 | \$194.00 | \$244.00 |
| TA | TRACK ARM ASSEMBLY - (Includes track, arm and screws) | 999025 | \$122.00 | |
| TAHO | TRACK ARM HOLD OPEN | 999027 | \$145.00 | |
| PA | PARALLEL ARM BRACKET - NON HOLD OPEN applications | 999001 | \$22.00 | \$72.00 |
| PAHO | PARALLEL ARM BRACKET- HOLD OPEN applications | 999022 | \$33.00 | |
| PS | PIVOT STOP ARM - Regular and Top Jamb Only | 999018 | \$184.00 | |

5300/5500
SERIES
DOOR CLOSERS

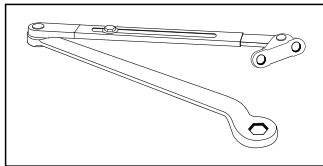

RA - REGULAR ARM

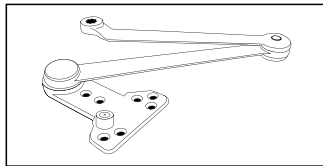

DS - DOOR SAVER (LIMITING STOP) ARM

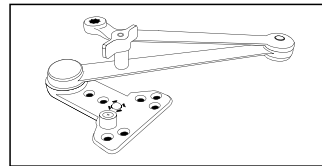

DSHO - DOOR SAVER (LIMITING STOP) HOLD OPEN ARM

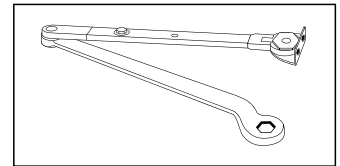

HO - HOLD OPEN ARM

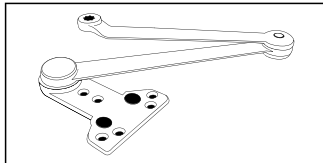

EDA - EXTRA DUTY ARM

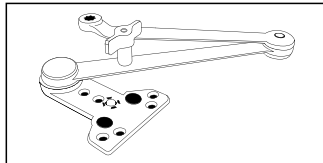

EDAHO - EXTRA DUTY ARM HOLD OPEN

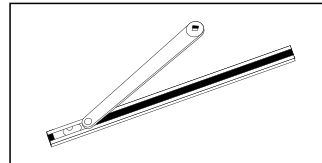

TA - TRACK ARM ASSEMBLY

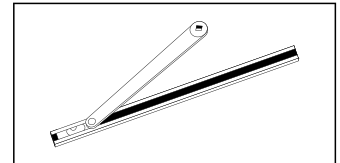

TAHO - TRACK ARM HOLD OPEN

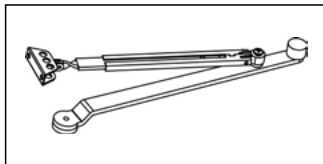

PS - PIVOT STOP ARM

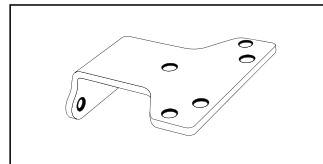

PA - PARALLEL ARM BRACKET

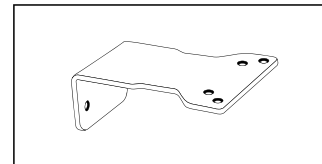

PAHO - PARALLEL ARM HO BRACKET

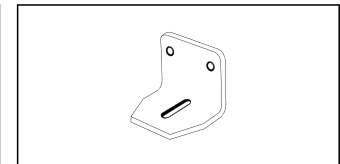

NFB - NARROW FRAME BRACKET

Covers

| CODE | DESCRIPTION | PART NO. (SPECIFY FINISH) | LIST PRICE | |
|-----------|---|------------------------------|----------------------------|-------------------|
| | | | PAINTED 689/693/695/696 | PLATED 605/625 |
| FC | 5500 SERIES FULL PLASTIC COVER (field reversible) | 559006 | \$45.00 | \$90.00 |
| SV | 5300 SERIES STREAMLINE PLASTIC COVER (non-handed) | 539006 | | |

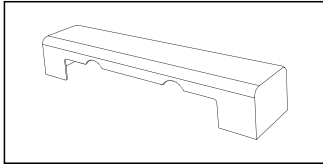

FC - FULL PLASTIC COVER (5500)

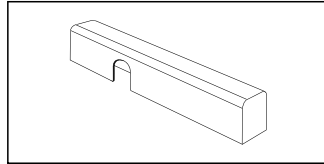

SV - STREAMLINE PLASTIC COVER (5300)

Mounting Plates

| CODE | DESCRIPTION | PART NO. (SPECIFY FINISH) | LIST PRICE |
|-------------|---|------------------------------|----------------------------|
| | | | PAINTED 689/693/695/696 |
| BP | BACK PLATE - For regular arm applications to clear mortised stop/holder | 539008/559008 | \$80.00 |
| DPTJ | TOP JAMB DROP PLATE - Required to mount TJ with limited ceiling clearance or to clear surface applied stop/holder | 999023 | |
| DPPA | PARALLEL ARM DROP PLATE - Required for parallel arm mount with limited top door rail | 559018 | |
| BS* | BLADE STOP SPACER - Shims all PA brackets to clear 1/2" blade stop (no finish) | 999026 | |
| NFB | NARROW FRAME BRACKET - For DS/DSHO/EDS/EDAHO arms, PA and BS brackets for added reinforcement (no finish) | 999011 | \$48.00 |

*Note: When using a Blade Stop Spacer in a narrow frame application you must use the (NFB) Narrow Frame Bracket for proper support.

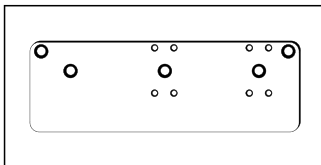

BP - BACK PLATE
(539008/559008)

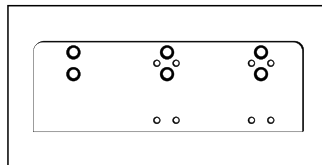

DPTJ - TOP JAMB DROP PLATE

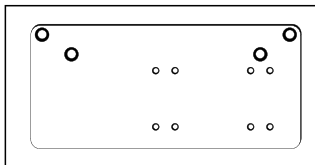

DPPA - PARALLEL ARM DROP PLATE

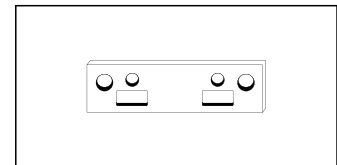

BS - BLADE STOP SPACER

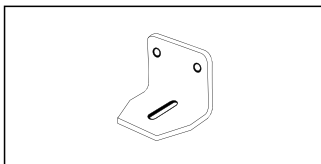

NFB - NARROW FRAME BRACKET

Fasteners

| CODE | DESCRIPTION | PART NO. (SPECIFY FINISH) | LIST PRICE | |
|-------------|---|------------------------------|----------------------------|-------------------|
| | | | PAINTED 689/693/695/696 | PLATED 605/625 |
| SDST | SELF DRILLING SELF TAPPING SCREWS | 999007 | \$17.00 | \$35.00 |
| SP | SCREW PACK | 999020 | | |
| SNB | SEX NUTS AND BOLTS -For through bolting on unreinforced hollow core, composite or labeled fire doors 1-3/4" only. (set of 4 each) | 999004 | | |

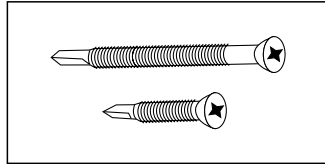

SDST - SELF DRILLING SELF TAPPING SCREWS

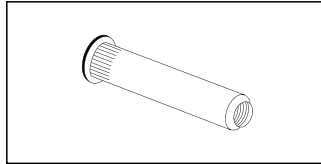

SNB - SEX NUTS AND BOLTS

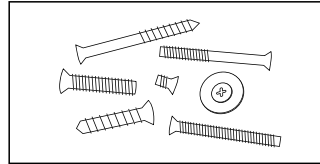

SP - SCREW PACK

5300/5500 SERIES DOOR CLOSERS

Parts

| CODE | DESCRIPTION | PART NO. (SPECIFY FINISH) | LIST PRICE | |
|---------------|---|------------------------------|-------------------------------|-------------------|
| | | | PAINTED 689/693 695/696 | PLATED 605/625 |
| DSBS | DOOR SAVER BUMPER STOP - (no finish) Used on DS, DSHO, PS arms | 999010 | \$22.00 | - |
| SPBL | PLASTIC SPACER BLOCK - For DS/DSHO/EDA/EDAHO and PA soffit brackets (no finish) | 999031 | \$10.00 | |
| HO KIT | TA ARM TO MAKE TAHO (no finish) | 999030 | \$35.00 | |
| SCS | SPRING CUSHION STOP* - USE with DS/DSHO for 3'0" doors (specify finish), for PA mount arms only | 999032 | \$150.00 | |
| SCS | SPRING CUSHION STOP* - For DS/DSHO for 4'0" doors, (specify finish), for PA mount arms only | 999033 | | |

* Spring Cushion Stop Function requires purchase of a PDQ DS or DSHO arm.

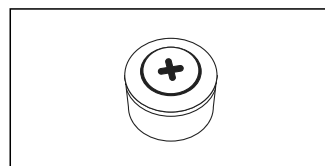

DSBS - DOOR SAVER BUMPER STOP

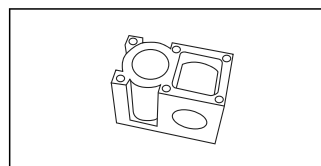

SPBL - PLASTIC SPACER BLOCK

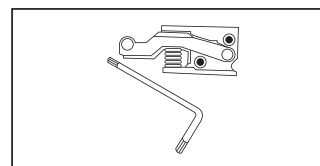

HO KIT - TA ARM TO MAKE TAHO

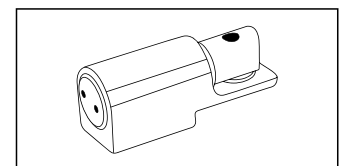

SCS - SPRING CUSHION STOP

| SCS FINISH | CLOSER FINISH |
|------------|---------------|
| 605 (PVD) | 605/696 |
| 613E (PVD) | 695 |
| 630 | 625/626/689 |
| 693 | 693 |

3100 SERIES

Grade 1 Light Commercial Closer

Typical Applications

- Aluminum Storefronts
- Assisted Living
- Hospitality
- Interior Offices
- Multi-family

Features

- Traditional door style door control for use in commercial door applications
- Fasteners are provided to facilitate installation on wood, hollow metal and aluminum doors and frames
- The closers are non-handed and tri-packed for maximum versatility to permit regular, top-jamb and parallel arm installations
- The common 9-1/16" mounting hole pattern permits simple installation on new and retrofit applications.
- Maximum 3-11/16" reveal for Top Jamb.

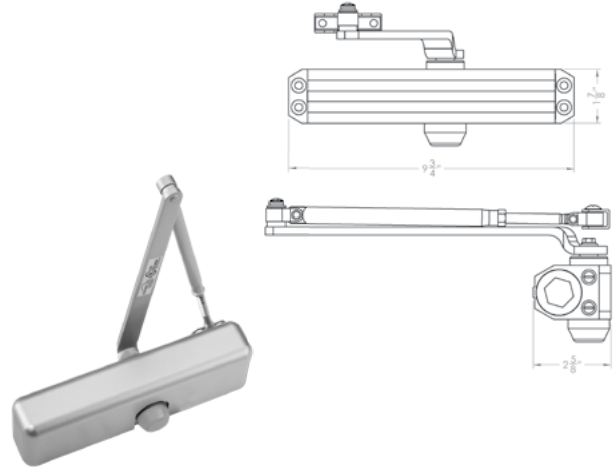

Specifications



| | |
|------------------------------------|--|
| BODY: | • High strength aluminum alloy |
| ARM OPTIONS: | <ul style="list-style-type: none"> • PA – Parallel Arm • PS – Pivot Stop Arm • HO – Hold Open • DS/DSHO – Heavy Duty Parallel Arm Stop • RA – Regular Arm • SCS/SCSHO – Heavy Duty Parallel Arm Cushion Stop |
| ADJUSTMENT: | <ul style="list-style-type: none"> • Separate hydraulic backcheck standard • Hydraulic controlled closing standard |
| SIZE: | <ul style="list-style-type: none"> • 3101 = Adjustable  BF - 4 • 3100 = Adjustable 3 - 6 |
| MOUNTING: | <ul style="list-style-type: none"> • Common 9-1/16" x 3/4" mounting hole pattern retrofits Yale® 50, Norton® 1600 • Tri-packed for regular, top jamb and parallel arm installations • Includes sex nuts/bolts and screws for wood, metal doors frames • Self drilling self tapping screws standard • Separate limiting stop may be required for high abuse applications |
| COVER: | • Streamline plastic cover optional |
| COLOR FINISHES: | • 689 – Aluminum, 693 – Black, 695 – Duro Bronze, 696 – Gold |
| WARRANTY: | • Twenty-five (25) year Limited Warranty |
| CERTIFICATIONS COMPLIANCES: | <ul style="list-style-type: none"> • UL listed for labeled swinging fire doors rated up to and including 3 hours • Certified to ANSI/BHMA A156.4 Grade 1 • Complies with ADA (Americans with Disabilities Act) and ICC/ANSI 117.1 for Accessible and Usable Buildings • TAA compliant. Country of origin: KR |

How to Order

| QUANTITY | SERIES | SIZE | BACKCHECK | ARM TYPES | FINISH | ACCESSORIES |
|----------|--------|--|--|---|--|--|
| 10 | 31 | 00 | BC | PA | 689 | — |
| | | 00 – Adjustable Size 3-6 01 – Adjustable Size BF - 4  | BC – Adjustable Hydraulic Backcheck | DS – Door Saver Arm DSHO – Door Saver Hold Open Arm HO – Hold Open, Tri-Pack PA – Tri-Pack (standard) RA – Regular Arm SCS – Spring Cushion Stop SCSHO – Spring Cushion Stop Hold open PS – Pivot Stop Arm BLANK – Body Only | 689 – Aluminum 693 – Black 695 – Duro Bronze 696 – Gold | BP – Back Plate BS – Blade Stop Spacer DP – Drop Plate NFB – Narrow Frame Bracket SV - Streamline Cover |
| | | | | | | PAGE 208 |

Closers

| PART | SIZE | DESCRIPTION | PAINTED 689/693/695/696 |
|--|------|---|----------------------------|
| 3100 SERIES – ADJUSTABLE SIZES 3-6 | | | |
| 3100 BC PA | 3-6 | Closer, SNB (Tri-pack) | \$158.00 |
| 3100 BC RA | 3-6 | Closer, regular arm, SNB | |
| 3100 BC PA SV | 3-6 | Closer, SNB (Tri-pack), Streamline Cover | \$168.00 |
| 3100 BC PA HO | 3-6 | Closer, hold open, SNB (Tri-pack) | \$247.00 |
| 3100 BC DS | 3-6 | Closer, door saver, SNB (PA Only) | \$281.00 |
| 3100 BC DSHO | 3-6 | Closer, door saver hold open, SNB (PA Only) | \$307.00 |
| 3100 BC SCS | 3-6 | Closer, door saver w/spring cushion stop, SNB (PA Only) | \$370.00 |
| 3100 BC SCSHO | 3-6 | Closer, door saver hold open w/spring cushion stop,SNB (PA Only) | |
| 3100 BC PS | 3-6 | Closer, pivot stop (SNB for closer body only) | |
| 3100 BC TA | 3-6 | Closer, track arm, streamline cover (SNB for closer body only) | \$250.00 |
| 3100 BC TAHO | 3-6 | Closer, rack arm hold open, streamline cover (SNB for closer body only) | \$260.00 |
| 3100 BC | 3-6 | Closer, body only | \$120.00 |
| 3101 SERIES – ADJUSTABLE SIZES BF-4 | | | |
| 3101 BC PA | BF-4 | Closer, SNB (Tri-pack) | \$158.00 |
| 3101 BC RA | BF-4 | Closer, regular arm, SNB | |
| 3101 BC PA SV | BF-4 | Closer, SNB (Tri-pack), Streamline Cover | \$168.00 |
| 3101 BC PA HO | BF-4 | Closer, hold open, SNB (Tri-pack) | \$247.00 |
| 3101 BC DS | BF-4 | Closer, door saver, SNB (PA Only) | \$281.00 |
| 3101 BC DSHO | BF-4 | Closer, door saver hold open, SNB (PA Only) | \$307.00 |
| 3101 BC SCS | BF-4 | Closer, door saver w/ spring cushion stop, SNB (PA Only) | \$370.00 |
| 3101 BC SCSHO | BF-4 | Closer, door saver hold open w/spring cushion stop, SNB (PA Only) | |
| 3101 BC TA | 3-6 | Closer, track arm, streamline cover (SNB for closer body only) | |
| 3101 BC TAHO | 3-6 | Closer, rack arm hold open, streamline cover SNB for closer body only) | \$250.00 |
| 3101 BC PS | BF-4 | Closer, pivot stop (SNB for closer body only) | \$260.00 |
| 3101 BC | BF-4 | Closer, body only | \$120.00 |

Accessories

| CODE | DESCRIPTION | LIST PRICE |
|-------------|-----------------------------------|----------------------------|
| | | PAINTED 689/693/695/696 |
| BS | Blade Stop Spacer (no finish) | \$80.00 |
| BP | Back Plate | |
| DPTJ | Drop Plate Top Jamb | |
| NFB | Parallel Arm NHO Bracket | \$48.00 |
| SDST | Self Drilling Self Tapping Screws | \$12.00 |

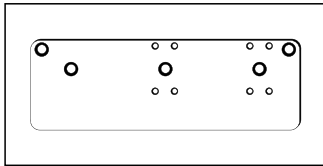

BP - BACK PLATE

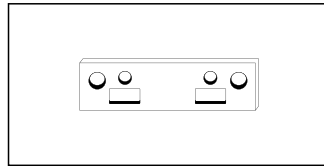

BS - BLADE STOP SPACER

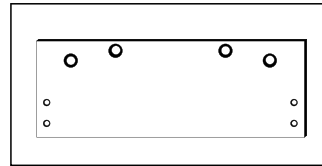

DPTJ - DROP PLATE

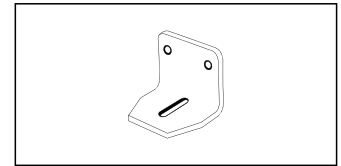

NFB - NARROW FRAME BRACKET

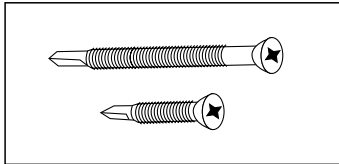

SDST - SELF DRILLING SELF TAPPING SCREWS

Spring Cushion Stops



**605
BRIGHT
BRASS**



**613E DARK OX-
IDIZED SATIN
BRONZE**



**630 SATIN
STAINLESS
STEEL**



693 BLACK

PDQ's SCS Series Spring Cushion Stop helps reduce wear and tear on the opening. As the door begins moving through back check to its maximum opening angle, the stop acts as a shock absorber, dampening the impact forces — See page 223

Arms

| CODE | DESCRIPTION | PART NO. (SPECIFY FINISH) | LIST PRICE |
|-------------|--|------------------------------|----------------------------|
| | | | PAINTED 689/693/695/696 |
| RA | REGULAR ARM - Can be mounted REG/TJ/PA (requires PA bracket) | 319003 | \$80.00 |
| DS | DOOR SAVER ARM (Limiting Stop) - PA application only | 999005 | \$160.00 |
| DSHO | DOOR SAVER HOLD OPEN ARM (limiting stop) PA application only | 999016 | \$194.00 |
| HO | HOLD OPEN ARM - can be mounted REG/TJ/PA (requires PA bracket) | 999002 | \$122.00 |
| PA | PARALLEL ARM BRACKET - NON HOLD OPEN applications | 999001 | \$22.00 |
| PAHO | PARALLEL ARM BRACKET- HOLD OPEN applications | 999022 | \$33.00 |
| PS | PIVOT STOP ARM - Regular and Top Jamb Only | 319018 | \$184.00 |

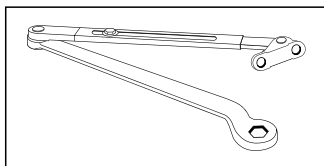

RA - REGULAR ARM

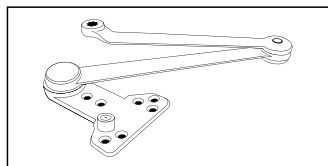

DS - DOOR SAVER (LIMITING STOP) ARM

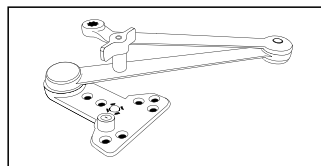

DSHO - DOOR SAVER (LIMITING STOP) HOLD OPEN ARM

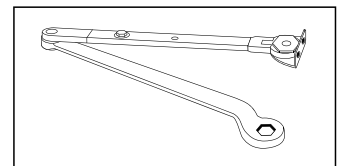

HO - HOLD OPEN ARM

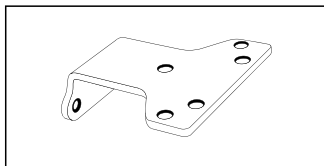

PA - PARALLEL ARM BRACKET

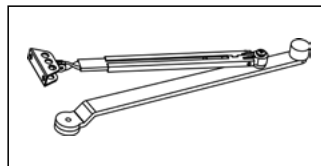
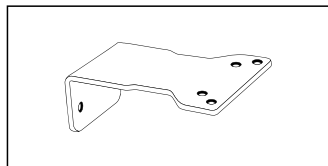

PS - PIVOT STOP ARM

Covers

| CODE | DESCRIPTION | PART NO. (SPECIFY FINISH) | LIST PRICE |
|------|--------------------------|------------------------------|----------------------------|
| | | | PAINTED 689/693/695/696 |
| SV | STREAMLINE PLASTIC COVER | 319006 | \$17.00 |

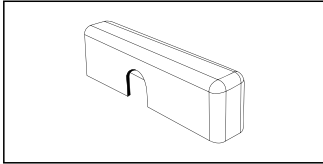

SV - STREAMLINE PLASTIC COVER

Mounting Plates

| CODE | DESCRIPTION | PART NO. (SPECIFY FINISH) | LIST PRICE |
|------|---|------------------------------|----------------------------|
| | | | PAINTED 689/693/695/696 |
| BS* | BLADE STOP SPACER - Shims all PA brackets to clear 1/2" blade stop (no finish) | 999026 | \$80.00 |
| BP | BACK PLATE - For regular arm applications to clear mortised stop/holder | 319008 | |
| DPTJ | TOP JAMB DROP PLATE - Required to mount TJ with limited ceiling clearance or to clear surface applied stop/holder | 319009 | |
| NFB | NARROW FRAME BRACKET - For DS/DSHO/EDS/EDAHO arms, PA and BS brackets for added reinforcement (no finish) | 999011 | \$48.00 |

*Note: When using a Blade Stop Spacer in a narrow frame application you must use the (NFB) Narrow Frame Bracket for proper support.

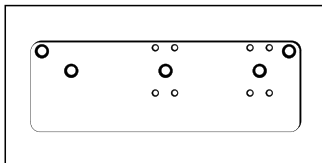

BP - BACK PLATE

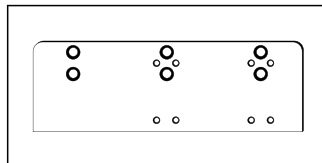

DPTJ - TOP JAMB DROP PLATE

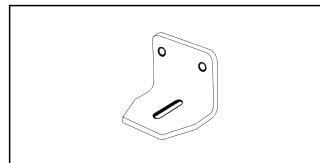

NFB - NARROW FRAME BRACKET

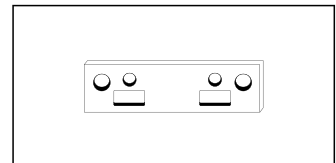

BS - BLADE STOP SPACER

Fasteners

| CODE | DESCRIPTION | PART NO. (SPECIFY FINISH) | LIST PRICE |
|------|---|------------------------------|----------------------------|
| | | | PAINTED 689/693/695/696 |
| SDST | SELF DRILLING SELF TAPPING SCREWS | 999007 | \$12.00 |
| SP | SCREW PACK | 319020 | |
| SNB | SEX NUTS AND BOLTS -For through bolting on unreinforced hollow core, composite or labeled fire doors 1-3/4" only. (set of 4 each) | 999004 | |

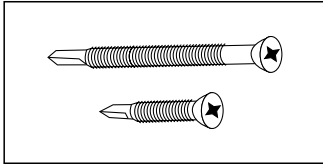

SDST - SELF DRILLING SELF TAPPING SCREWS

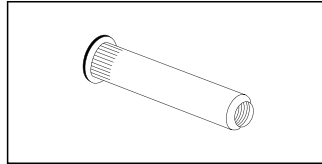

SNB - SEX NUTS AND BOLTS

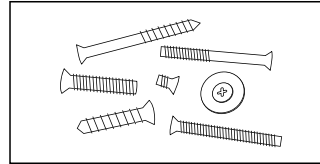

SP - SCREW PACK

Parts

| CODE | DESCRIPTION | PART NO. (SPECIFY FINISH) | LIST PRICE |
|------|---|------------------------------|----------------------------|
| | | | PAINTED 689/693/695/696 |
| DSBS | DOOR SAVER BUMPER STOP - (no finish) Used on DS, DSHO, PS arms | 999010 | \$22.00 |
| SPBL | PLASTIC SPACER BLOCK - For DS/DSHO/EDA/EDAHO and PA soffit brackets (no finish) | 999031 | \$10.00 |
| SCS | SPRING CUSHION STOP* - USE with DS/DSHO for 3'0" doors (specify finish), for PA mount arms only | 999032 | \$150.00 |
| SCS | SPRING CUSHION STOP* - For DS/DSHO for 4'0" doors, (specify finish), for PA mount arms only | 999033 | |

* Spring Cushion Stop requires purchase of a PDQ DS or DSHO arm.

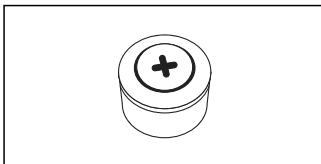

DSBS - DOOR SAVER BUMPER STOP

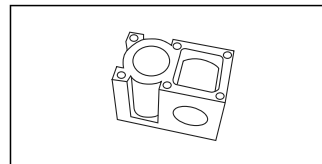

SPBL - PLASTIC SPACER BLOCK

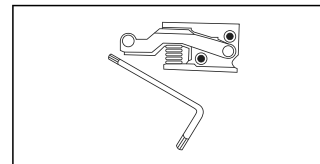

HO KIT - TA ARM TO MAKE TAHO

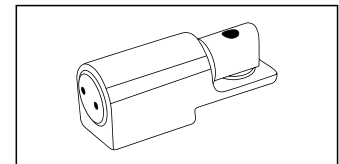

SCS - SPRING CUSHION STOP

Spring Cushion Stop (SCS) Finish Match to Closers

| SCS FINISH | CLOSER FINISH |
|------------|---------------|
| 605 (PVD) | 605/696 |
| 613E (PVD) | 695 |
| 630 | 625/626/689 |
| 693 | 693 |

Cross Reference

| MANUFACTURER | CLOSER SERIES | | | | |
|--------------------|---------------|-----------|-----------|-----------|-----------------|
| PDQ | 7100 | 5500 | 5300 | 5100 | 3100 |
| CAL ROYAL | CR441 | CR801 | CR801S | 900 | 300 |
| CORBIN/RUSSWIN | DC8000 | DC6200 | DC3200 | N/A | N/A |
| DORMA | 8900 | 8616FC | 8616 | 7414/7436 | 3800 |
| FALCON | SC70 | SC850FC | SC80 | SC60/SC61 | SC60 |
| HAGER | 5100 | 5200 | 5200 | N/A | 5300 LESS COVER |
| STANLEY COMMERCIAL | QDC100 | QDC200F | QDC200S | N/A | QDC300 |
| LCN | 4040 | 1460/1461 | 1460/1461 | 1370 | 1260 |
| NORTON | 7500 | 8500 | 8300 | 160 | 1600 |
| SARGENT | 281 | 350 | 1430 | 1130/1131 | 1130 |
| STANLEY | D-4550 | D-3550 | N/A | N/A | D-1650 |
| YALE | 5800/4400 | 3500 | 3300 | 51 | 50 |

Mounting Position

Regular Arm

Regular arm mount is a pull side application with double lever arm. The closer mounts on the door and the arm mounts to the frame. It provides the most efficient operation for door control and is commonly used on in-swing doors from corridors or other interior doors. Regular arm mount is a poor choice for exterior out-swinging doors as it would put the closer on the exterior of the building. The arm assembly projects directly out from the frame. That may be a concern for vandalism or aesthetics. Regular arm application can be used with non-hold open or hold open arms.

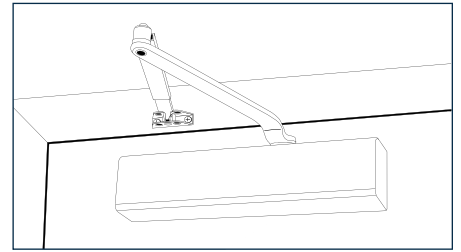

Top Jamb

Top jamb mount is a push side double lever arm application that offers the best alternative to regular arm mount. The closer mounts to the frame and the arm mounts to the door. This application is commonly used on exterior out-swinging doors. It is a poor application for in-swinging doors from a corridor as it places the closer arm in a visible application projecting into the corridor. The arm projects out similar to regular arm mount. Therefore, it can be a concern for vandalism or aesthetics. Top jamb application can be used with non-hold open or hold open arms.

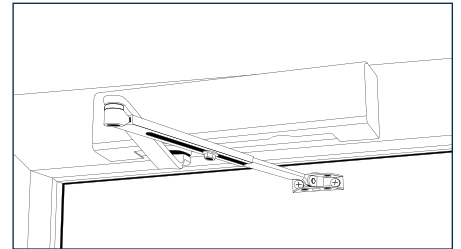

Parallel Arm

Parallel arm mount is a push side double lever arm application. The closer is installed on the push side of the door and the arm is mounted to a parallel arm adapter plate installed to the frame soffit. The arm is approximately parallel with the face of the door, eliminating the projection condition evident with regular arm and top jamb applications. Parallel arm is often preferred where aesthetics or vandalism are concerns. Parallel arm is less efficient than regular or top jamb mounts due to the geometry of the arm. Parallel arm application can be used with non-hold open or hold open arms.

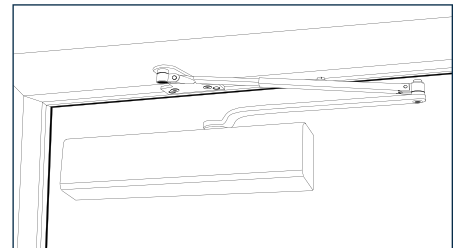

Parallel Stop Arm (DS/DSHO) Extra Duty PA Arm (EDA/EDAHO)

The parallel stop arm mount is an enhanced version of the parallel arm application. It is similar to the parallel arm mount but incorporates a heavy duty rigid arm and soffit plate with limiting dead stop. The dead stop feature is field handed. The closer's back check function should be adjusted to cushion the impact of the stop. The parallel stop arm is intended for use where an auxiliary stop cannot be utilized. The parallel stop arm is available in non-hold open (DS) and hold open (DSHO) applications.

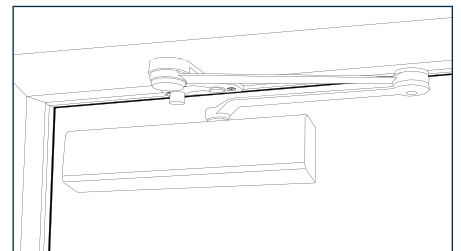

Recommend using the SCS Spring Cushion Stop for moderate to high abuse installations.

For Extra Duty PA Arm applications, specify EDA or EDAHO. Similar to DS/DSHO without the stop. Requires separate limiting stop by others.

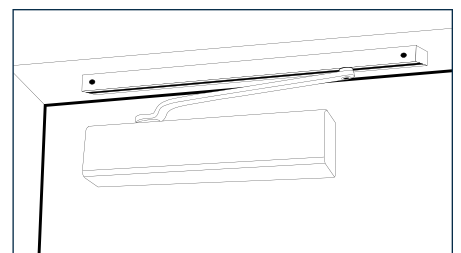

Track Arm (TA)

The non-handed Track Arm mount incorporates a single stamped arm not designed to be used as a limiting dead stop. It's low profile helps to eliminate projecting arm conditions, which can reduce vandal damage.

Pivot Stop (PS)

The PS (Pivot Stop) arm is designed to serve as a medium-duty door stop for situations where a door stop or overhead stop is not practical. Available in Regular and Top Jamb mounting, the PS arm uses back check to slow the door and a stop integrated into the closer arm to limit the travel of the door. The PS arm limits the travel of the door to a specific, templated angle. Templating is available for opening angles from 85 to 110 degrees in 5 degree increments. The PS arm is not available with hold-open.

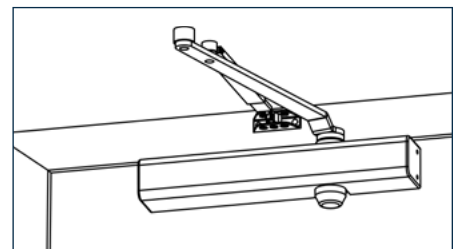

SPRING CUSHION STOP



630 SATIN STAINLESS
STEEL



613E DARK OXIDIZED
SATIN BRONZE



605 BRIGHT
BRASS



693 BLACK

PDQ's SCS Series Spring Cushion Stop helps reduce wear and tear on the opening. As the door begins moving through backcheck to its maximum opening angle, the stop acts as a shock absorber, dampening the impact forces.

Features

- The unit is an **add-on kit** that can be included as an option on DS/DSHO arms.
- It also can be installed on existing DS/DSHO arm applications using the existing threaded hole for the bumper stop and one of the mounting screw holes.
- The spring cushion kit is available in two spring sizes, allowing it to be tailored to provide more effective cushioning for specific door widths
- Designed to be self aligning, the unit works with any door that incorporates a PDQ DS/DSHO arm with a cushioned bumper (won't fit with old style metal bumper).
- Manufactured from investment cast stainless steel for corrosion resistance and durability
- The 99032/99033 does not alter or decrease the strength of the DS/DSHO arm.
- Hand is determined in the field and reversible for LH and RH doors

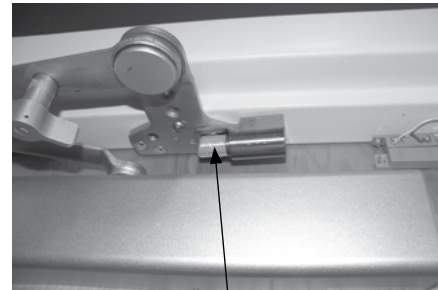

NOTE: PLUNGER HIGHLIGHTED TO ENHANCE THE CUSHIONING FEATURE.

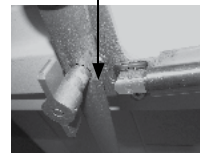

STOP SHOWN BEFORE
DOOR IS FULLY OPENED

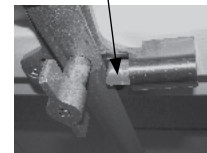

STOP SHOWN WHEN
DOOR IS FULLY OPENED

Specifications



| | |
|--------------------|--|
| HANDING: | • Field Reversible |
| DOOR SIZES: | • SCS-1 for 3'0" X 8'0" doors • SCS-2 for 4'0" X 8'0" doors |
| FINISHES: | • 605 (US3) – Bright Brass (PVD), 613E – Dark Oxidized Satin Bronze (PVD), 630 (US32D) – Satin Stainless Steel, 693 – Black Note: PVD (Physical Vapor Deposition) coated finishes offer outstanding resistance to wear, durability and corrosion. |

Spring Cushion Stop

| PART | CODE | DESCRIPTION | LIST PRICE 605/613E/630/693 |
|--------------------------|--------------|---|--------------------------------|
| 999032 Specify Finish | SCS-1 | For 3'0" X 8'0" wood or hollow metal doors and frames | \$150.00 |
| 999033 Specify Finish | SCS-2 | For 4'0" X 8'0" wood or hollow metal doors and frames | |

Locks

MR199A
Electrified Mortise

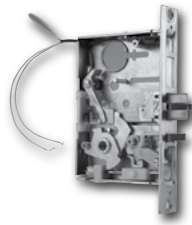

Applications
Electrified locks complement the mechanical offering and are typically incorporated into a wired access control system or used independently with a remote access switch. - p. 9

XGT/GT199A
Electrified Cylindrical



Applications
Electrified locks complement the mechanical offering and are typically incorporated into a wired access control system or used independently with a remote access switch. - p. 34

Exit Devices and Trim

6300/6400
Electrified Options



Applications
Access control exit device options including request to exit signal switch, latch bolt monitor, and battery powered alarms.

6W99
Electrified Trim



Applications
Electrified trim complements the mechanical offering and is typically incorporated into a wired access control system or used independently with a remote access switch. — p. 160

MLR
Motorized Latch Retraction

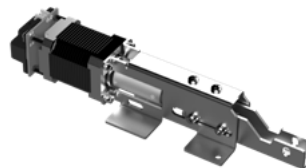

Applications
An ideal solution for integrated exit device access control solutions requiring operational noise reduction such as Healthcare, K-12, higher education, museums, auditoriums, theaters, etc.

DE
Delayed Egress



Applications
This Delayed Egress exit device is designed to slow the egress or exit from a particular area, usually for security reasons or to prevent unauthorized access. Designed for the 6300 and 6400 exit device. Available in Rim, concealed vertical rod, and mortise devices.

Electrified Hinges



Applications

Electric hinges are used when a locking device is mounted on a moving door and power and signals must be brought off the door to the controller and house wiring. Examples of such locking devices include an electrified lockset or electrically actuated trim, electric latch retraction device or a switching device such as a REX lever or touchbar. — p. 226

Electric Strikes



Applications

Electromechanical door locking device for use with various latch bolt locksets in lieu of conventional Strikes that provide additional security, traffic control and convenience of remote operation. — p. 217

Key Switches



Applications

Key switches can be activated only by the use of a key. Typical applications include situations where access needs to be restricted to the switch's functions. — p. 218

Push Buttons



Applications

Commonly used on ADA openings in conjunction with an automatic operator. — p. 218

Power Supplies



Applications

Power sources used to support electronic access control devices. — p. 219

8500/9910 SERIES

Electric Strikes

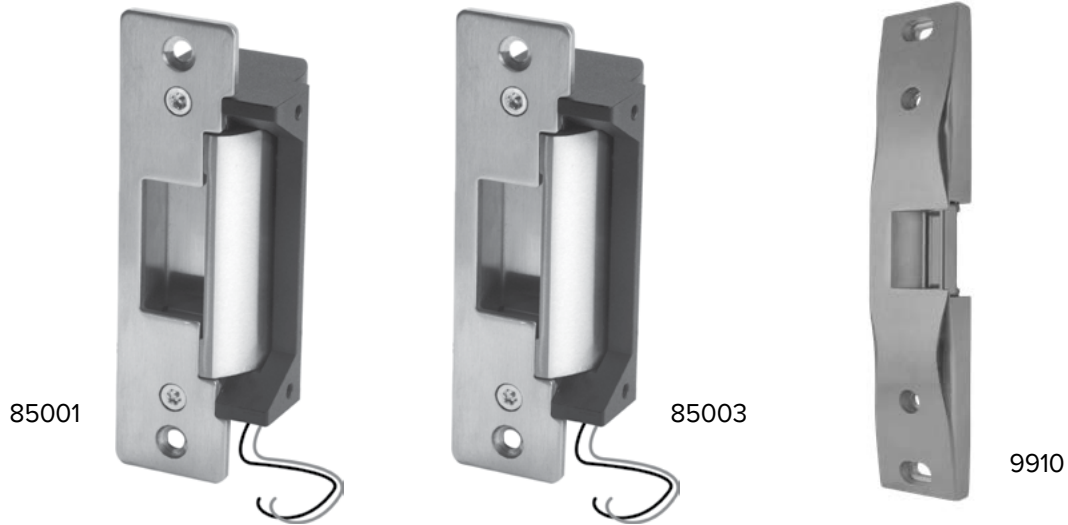

Specifications for 85001 and 85003

| | |
|-------------------------------|--|
| 85001 ELECTRIC STRIKE: | • Designed for use with all PDQ Grade 1 and Grade 2 Cylindrical Locks |
| 85003 ELECTRIC STRIKE: | • Designed for use with all PDQ MR Series Mortise Locks WITHOUT Deadbolt |
| FEATURES: | <ul style="list-style-type: none"> • Input voltage:12-24 VDC • Field changeable from FAIL SECURE to FAIL SAFE • Factory tested to 1,000,000 cycle |
| CURRENT: | <ul style="list-style-type: none"> • 0.28A @ 12 VDC • 0.14A @ 24 VDC |
| FINISH: | • 630 (US32D) Satin Stainless Steel |

Specifications for 9910 **Available in Q2, 2024**

| | | |
|------------------|--|---|
| FEATURES: | <ul style="list-style-type: none"> • Completely surface-mounted • Accommodates 1/2" to 3/4" (13mm–19mm) latch projection • Mounting spacer included to provide enhanced latch engagement • Stainless steel ensures superior strength and creates a sleek aesthetic design • Horizontal adjustment ensures proper latch positioning to compensate for door misalignment – up to 1/4" (6.4mm) • Conventional keeper design • Plug-in wire connectors • Lockdown holes for secure mount | <ul style="list-style-type: none"> • HEX socket head cap screws for added support • Installation tool included • Non-handed • 500mA Field-Selectable 12/24VDC & 12-24VAC (Max at 12VDC) • 1,500lbf Static • 70 ft-lb Dynamic • 250,000 Cycles • Fail-Secure • 3-Hour Fire Rated • 5 Year Limited Warranty |
|------------------|--|---|

Electric Strikes

Designed for use with PDQ's Grade 1 Mortise Locks, Grade 1 and 2 Cylindrical Locks, and 63/6400 Exit Devices

| PART NO. | DESCRIPTION | LIST PRICE |
|----------|---------------------------------|------------|
| 85001 | For Cylindrical Locks | \$650 |
| 85003 | For Mortise locks (no Deadbolt) | |
| 9910 | For 6300 / 6400 Exit Devices | \$1125 |

8100 SERIES

Key Switches Push Buttons



Key Switch W/Lights
81310-2MT / 81310-2MM



Key Switch
81310-4MT / 81310-4MM



Push Button Switch
81320-1MT / 81320-1MM



Mushroom Push Button
81320-5MT / 81320-5MM

Electrified Accessories

| PART NUMBER | DESCRIPTION | LIST PRICE |
|-------------|--------------------------------------|------------|
| 81310-2MT | 62 Key Switch with Lights Maintained | \$386.00 |
| 81310-2MM | 62 Key Switch with Lights Momentary | |
| 81310-4MT | 62 Key Switch Narrow Maintained | \$352.00 |
| 81310-4MM | 62 Key Switch Narrow Momentary | |
| 81320-1MT | 62 Push Button Maintained | \$246.00 |
| 81320-1MM | 62 Push Button Momentary | |
| 81320-5MT | 62 Push Button Mushroom Maintained | \$376.00 |
| 81320-5MM | 62 Push Button Mushroom Momentary | |
| 81320-6MT | 62 Push Button Narrow Maintained | \$280.00 |
| 81320-6MM | 62 Push Button Narrow Momentary | |

PS SERIES

Power Supplies



MADE IN
THE USA



Features

- Filtered/Regulated 24 Volts DC
- Overload, Over Voltage and Short Circuit Protection
- Accepts 110-120VAC
- Controls Fail Safe or Fail Secure Locking Devices
- Interface Relay Isolates Locking Device Current from Control Switch
- Auxiliary 24VDC Constant Voltage Output for Powering Stand Alone Devices, Such as, Keypads, Motion Detectors and Status Indicators (Model PS220 and PS22B only)
- Surge Suppression on Fail Safe and Fail Secure Outputs
- UL Listed and Tested to 294 Standard for Access Control System Units
- 3 year warranty
- Made in the USA



| PART | DESCRIPTION | LIST PRICE |
|--------|--|------------|
| PS220 | 2A @ 24VDC Power Supply w/ Fire Alarm Link and 0.5A auxiliary power (continuous) | \$950.00 |
| PS220B | 2A @ 24VDC Power Supply w/ Fire Alarm Link, 0.5A auxiliary power (continuous) and Battery Backup (batteries sold separately) | \$1077.00 |
| PS440B | 4A @ 24VDC Power Supply w/ Fire Alarm Link, and Battery Backup (batteries sold separately) | \$1152.00 |
| PS480B | 8A @ 24VDC Power Supply w/ Fire Alarm Link, and Battery Backup. Batteries not included (accommodates 2 ea. 7AH batteries) | \$1224.00 |



Commercial Hinges



Electrified Hinges

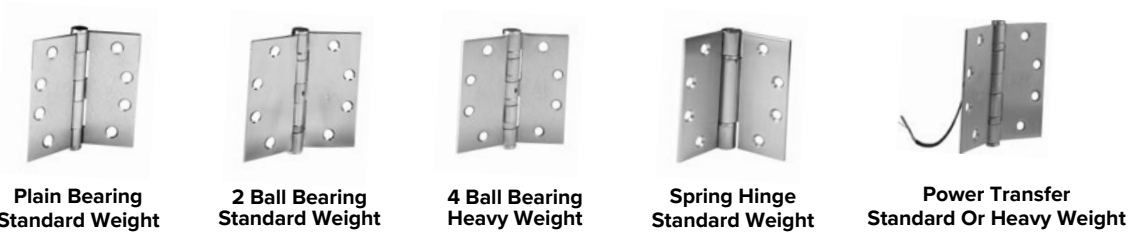

Specifications



| | |
|---|--|
| MATERIALS: | <ul style="list-style-type: none"> • STEEL — Applications: Interior doors, non-corrosive environments. • STAINLESS STEEL — Applications: Exterior, doors, corrosive environments |
| PACKAGING: | <ul style="list-style-type: none"> • Qty Of Hinges Per Individual Carton: 3 ea For Plain, 2 Ball Bearing and 4 Ball Bearing Hinges 3 ea For Spring Hinges 1 ea for Electrified Hinges • Qty Of Hinges Per Master Carton: 48 ea For Plain, 2 Ball Bearing and 4 Ball Bearing Hinges |
| FASTENERS: | <ul style="list-style-type: none"> • All hinges packed with Machine Screws (12-24 x 1/2" FHMS) and Wood Screws (12 x 1-1/4" FHWS) |
| CERTIFICATIONS, LISTINGS, COMPLIANCES: | <ul style="list-style-type: none"> • Conforms with the requirements of NFPA 80-2010, Section 6.4.3.1. • Certified to ANSI/BHMA A156.1-2013: <ul style="list-style-type: none"> — Grade 3, Plain Bearing (PL) 350,000 cycles — Electrified hinges tested to over 100,000 cycles • UL listed: <ul style="list-style-type: none"> — SH Series Spring Hinges — EL Series Electrified Hinges |
| WARRANTY: | <ul style="list-style-type: none"> • Five (5) year limited warranty |

Cross Reference

| HINGE DESCRIPTION | PDQ | ANSI | BOMMER | HAGER | MCKINNEY | PBB | STANLEY |
|---|--------|----------|---------|-----------|-----------|------|---------|
| Plain Bearing, Standard Weight – Steel | 35STPL | A8133 | 5000 | 1279 | T2714 | PB81 | F179 |
| | | | | EC1100 | MP79 | | |
| 2 Ball Bearing, Standard Weight – Steel | 35STBB | A8112 | BB5000 | BB1279 | TA2714 | BB81 | FBB179 |
| | | | | ECBB1100 | MPB79 | | |
| 2 Ball Bearing, Standard Weight – Stainless Steel | 35SSBB | A5112 | BB5002 | BB1191 | TA2314 | BB51 | FBB191 |
| | | | | (630/32D) | (630/32D) | | |
| 4 Ball Bearing, Heavy Weight – Steel | 35STHB | A8111 | BB5004 | BB1168 | T4A3786 | 4B81 | FBB168 |
| | | | | ECBB1102 | MPB68 | | |
| 4 Ball Bearing, Heavy Weight – Stainless Steel | 35SSHB | A5111 | BB5006 | BB1199 | T4A3386 | 4B51 | FBB199 |
| | | | | ECBB1103 | MPB68 | | |
| Spring Hinge, Self Closing – Steel | 35STSH | K8107-1F | LB4310C | 1250 | 1502 | SP81 | 2060R |
| | | | | EC1105 | MPS60 | | |

Quick Reference Guide

| PDQ HINGE MODEL* | FINISH ANSI (US) | ANSI NUMBER* | STYLE | BASE MATERIAL | SIZE | FREQUENCY | WEIGHT | THICK-NESS | SWAGING |
|--|------------------|--------------|-----------------|-----------------|-----------------|-----------|----------|-------------|----------------|
| FULL MORTISE HINGES | | | | | | | | | |
| 35 ST PL 4040 600 | 600 (P) | A8133 | PLAIN | STEEL | 4" x 4" | LOW | | .130"±.005" | 2 LEAVES |
| 35 ST PL 4040 652 | 652 (26D) | | | | | | | | |
| 35 ST PL 4545 600 | 600 (P) | | | | | | | | |
| 35 ST PL 4545 613E | 613E (10B) | | | | | | | | |
| 35 ST PL 4545 652 | 652 (26D) | | | | | | | | |
| 35 ST BB 4545 600 NRP | 600 (P) | A8112 w/NRP | 2 BALL BEARING | STEEL | 4-1/2" x 4-1/2" | STANDARD | | | |
| 35 ST BB 4545 605 NRP | 605 (3) | | | | | | | | |
| 35 ST BB 4545 613E NRP | 613E (10B) | | | | | | | | |
| 35 ST BB 4545 652 NRP | 652 (26D) | | | | | | | | |
| 35 ST BB 4540 652 NRP | | | | | | | | | |
| 35 SS BB 4035 630 NRP | 630 (32D) | A5112 w/NRP | | STAINLESS STEEL | 4" x 3-1/2" | MEDIUM | | | |
| 35 SS BB 4040 630 NRP | | | | | 4" x 4" | | | | |
| 35 SS BB 4540 630 NRP | | | | | 4-1/2 x 4" | | | | |
| 35 SS BB 4545 630 NRP | | | | | | | | | |
| 35 ST HB 4545 600 NRP | | | | | 600 (P) | | | A8111 w/NRP | 4 BALL BEARING |
| 35 ST HB 4545 605 NRP | 605 (3) | | | | | | | | |
| 35 ST HB 4545 613E NRP | 613E (10B) | | | | | | | | |
| 35 ST HB 4545 652 NRP | 652 (26D) | | | | | | | | |
| 35 ST HB 5045 652 NRP | | | | | | | | | |
| 35 SS HB 4545 630 NRP | 630 (32D) | A5111 w/NRP | | STAINLESS STEEL | 4-1/2" x 4-1/2" | | | | |
| 35 SS HB 5045 630 NRP | | | | | 5" x 4-1/2" | | | | |
| SPRING HINGES | | | | | | | | | |
| 35 ST SH 4545 613E | 613E (10B) | K8107-1F | | STEEL | 4-1/2" x 4-1/2" | MEDIUM | STANDARD | .134+-.005 | 2 LEAVES |
| 35 ST SH 4545 613E | 613E (10B) | | | | | | | | |
| 35 ST SH 4545 652 | 652 (26D) | | | | | | | | |
| 35 SS SH 4545 630 | 630(32D) | K5107-1F | STAINLESS STEEL | | | | | | |
| ELECTRIFIED HINGES | | | | | | | | | |
| See Full Mortise Hinge Table above, 2 and 4 Ball Bearing Series. | | | | | | | | | |

*NRP = Non-Removable Pin

How to Order



| QUANTITY | SERIES | MATERIAL | STYLE | SIZE | FINISH | SECURITY FEATURE ² | ELECTRIFIED OPTIONS ¹ |
|----------|-------------------|------------------------------------|---|--|---|-------------------------------|---|
| 10 | 35 | ST | BB | 4545 | 630 | NRP | — |
| | 35 — Full Mortise | ST — Steel SS — Stainless Steel | PL — Plain Bearing BB — 2 Ball Bearing HB — 4 Ball Bearing SH — Spring Hinge | 4035 — 4" X 3-1/2" 4040 — 4" X 4" 4540 — 4-1/2" X 4" 4545 — 4-1/2" X 4-1/2" 5045 — 5" x 4-1/2" 5050 — 5" x 5" | 600 — Prime Coated 605 — Bright Brass 613E — Oil Rub Bronze 619 — Satin Nickel 622 — Black 626 — Satin Chrome 630 — Satin Stainless Steel | NRP — Non Removable Pin | EL 4 — Concealed electric through-wire (2 wires @ 20ga, 2 wires @ 26ga) EL 8 — Concealed electric through-wire (8 wires, 28ga) |

Ordering example: Plain bearing hinge: 35 ST PL 4545 600
4 Wire Std Weight Hinge: EL 4 35 SS BB 4545 630 NRP







Notes:

- 1- EL Series only available in 2 and 4 ball bearing. Includes NRP.
- 2 - NRP standard in 2 and 4 ball bearing.





Plain Bearing

| FULL MORTISE HINGES | DESCRIPTION | QTY OF HINGES PER CARTON | FINISH ANSI (US) | PDQ HINGE MODEL | LIST PRICE PER HINGE |
|---|---|--------------------------|------------------|-------------------|----------------------|
|  | 5 Knuckle Base Material: Steel Size: 4" x 4" Hinge Weight: Standard Frequency of Use: Low Thickness: .130" ± .005" Certified to ANSI 8133 | 3ea | 600 (P) | 35 ST PL 4040 600 | \$10.00 |
| | | | 652 (US26D) | 35 ST PL 4040 652 | |
|  | 5 Knuckle Base Material: Steel Size: 4-1/2" x 4-1/2" Hinge Weight: Standard Frequency of Use: Low Thickness: .130" ± .005" Certified to ANSI 8133 | 3ea | 600 (P) | 35 ST PL 4545 600 | \$11.00 |
| | | | 613 (10B) | 35 ST PL 4545 613 | |
| | | | 619(US15) | 35 ST PL 4545 619 | |
| | | | 622 (US19) | 35 ST PL 4545 622 | |
| | | | 652 (US26D) | 35 ST PL 4545 626 | |





2 Ball Bearing

| FULL MORTISE HINGES | DESCRIPTION | QTY OF HINGES PER CARTON | FINISH ANSI (US) | PDQ HINGE MODEL | LIST PRICE PER HINGE |
|---|---|--------------------------|------------------|-----------------------|----------------------|
|  | 5 Knuckle Base Material: Stainless Steel Size: 4" x 3-1/2" Hinge Weight: Standard Frequency of Use: Medium Thickness: .118" ± .005" Certified to ANSI A5112 | 3ea | 630 (US32D) | 35 SS BB 4035 630 NRP | \$29.00 |
|  | 5 Knuckle Base Material: Stainless Steel Size: 4" x 4" Hinge Weight: Standard Frequency of Use: Medium Thickness: .118" ± .005" Certified to ANSI A5112 | 3ea | 630 (US32D) | 35 SS BB 4040 630 NRP | \$32.00 |
|  | 5 Knuckle Base Material: Steel Size: 4-1/2" x 4" Hinge Weight: Standard Frequency of Use: Medium Thickness: .134" ± .005" Certified to ANSI A8112 | 3ea | 652 (US26D) | 35 ST BB 4540 626 NRP | \$10.00 |
|  | 5 Knuckle Base Material: Stainless Steel Size: 4-1/2" x 4" Hinge Weight: Standard Frequency of Use: Medium Thickness: .134" ± .005" Certified to ANSI A5112 | 3ea | 630 (US32D) | 35 SS BB 4540 630 NRP | \$35.00 |
|  | 5 Knuckle Base Material: Steel Size: 4-1/2" x 4-1/2" Hinge Weight: Standard Frequency of Use: Medium Thickness: .134" ± .005" Certified to ANSI A8112 | 3ea | 600 (P) | 35 ST BB 4545 600 NRP | \$11.00 |
| | | | 605 (US3) | 35 ST BB 4545 605 NRP | \$15.00 |
| | | | 613 (10B) | 35 ST BB 4545 613 NRP | \$11.00 |
| | | | 619 (US15) | 35 ST BB 4545 619 NRP | |
| | | | 622 (US19) | 35 ST BB 4545 622 NRP | |
| | | | 652 (US26D) | 35 ST BB 4545 652 NRP | |
|  | 5 Knuckle Base Material: Stainless Steel Size: 4-1/2" x 4-1/2" Hinge Weight: Standard Frequency of Use: Medium Thickness: .134" ± .005" Certified to ANSI A5112 | 3ea | 622 (US19) | 35 SS BB 4545 622 NRP | \$35.00 |
| | | | 630 (US32D) | 35 SS BB 4545 630 NRP | |

4 Ball Bearing

| FULL MORTISE HINGES | DESCRIPTION | QTY OF HINGES PER CARTON | FINISH ANSI (US) | PDQ HINGE MODEL | LIST PRICE PER HINGE |
|---|---|--------------------------|------------------|-----------------------|----------------------|
|  | 5 Knuckle Base Material: Steel Size: 4-1/2" x 4-1/2" Hinge Weight: Heavy Frequency of Use: High Thickness: .180" ± .005" Certified to ANSI 8111 | 3ea | 600 (P) | 35 ST HB 4545 600 NRP | \$26.00 |
| | | | 605 (US3) | 35 ST HB 4545 605 NRP | \$32.00 |
| | | | 613 (10B) | 35 ST HB 4545 613 NRP | |
| | | | 619 (US15) | 35 ST HB 4545 619 NRP | \$26.00 |
| | | | 622 (US19) | 35 ST HB 4545 622 NRP | |
| | | | 652 (US26D) | 35 ST HB 4545 626 NRP | |
|  | 5 Knuckle Base Material: Stainless Steel Size: 4-1/2" x 4-1/2" Hinge Weight: Heavy Frequency of Use: High Thickness: .180" ± .005" Designed to meet ANSI 5111 | 3ea | 630 (32D) | 35 SS HB 4545 630 NRP | \$60.00 |
|  | 5 Knuckle Base Material: Steel Size: 5" x 4-1/2" Hinge Weight: Heavy Frequency of Use: High Thickness: .180" ± .005" Designed to meet ANSI 8111 | 3ea | 652 (US26D) | 35 ST HB 5045 626 NRP | \$38.00 |
|  | 5 Knuckle Base Material: Stainless Steel Size: 5" x 4-1/2" Hinge Weight: Heavy Frequency of Use: High Thickness: .180" ± .005" Designed to meet ANSI 5111 | 3ea | 630 (32D) | 35 SS HB 5045 630 NRP | \$77.00 |
|  | 5 Knuckle Base Material: Stainless Steel Size: 5" x 5" Hinge Weight: Heavy Frequency of Use: High Thickness: .180" ± .005" Designed to meet ANSI 5111 | 3ea | 630 (32D) | 35 SS HB 5050 630 NRP | \$90.00 |



Spring Hinges

| SPRING HINGES | DESCRIPTION | QTY OF HINGES PER CARTON | FINISH ANSI (US) | PDQ HINGE MODEL | LIST PRICE PER HINGE |
|--|--|--------------------------|------------------|-------------------|----------------------|
|   | 3 Knuckle Base Material: Steel Size: 4-1/2" x 4-1/2" Hinge Weight: Standard Frequency of Use: Medium Thickness: .134" ± .005" Designed to meet ANSI K8107-1F | 3ea | 600 (P) | 35 ST SH 4545 600 | \$28.00 |
| | | | 613 (10B) | 35 ST SH 4545 613 | |
| | | | 619 (US15) | 35 ST SH 4545 619 | |
| | | | 622 (US19) | 35 ST SH 4545 622 | |
| | | | 652 (US26D) | 35 ST SH 4545 626 | |
| | | | 605 (US3) | 35 ST SH 4545 605 | |
|   | 3 Knuckle Base Material: Stainless Steel Size: 4-1/2" x 4-1/2" Hinge Weight: Standard Frequency of Use: Medium Thickness: .134" ± .005" Designed to meet ANSI K5107-1F | 3ea | 630 (32D) | 35 SS SH 4545 630 | \$64.00 |

Prepackaged Hinge Sets — Everything you could need, in one convenient package.

| | DESCRIPTION | FINISH | PDQ PART NUMBER | LIST PRICE PER KIT |
|---|---|--------|--------------------|--------------------|
|  | 2-Spring Hinge 4545 1-Ball Bearing Hinge | 626 | 35 ST SHP 4545 626 | \$64.00 |

Electrified Hinges

| | FEATURES | QTY OF HINGES PER CARTON | CODE | DESCRIPTION | HINGE ADJUSTMENT |
|---|---|--------------------------|------|--|------------------|
|  |  | 1ea | EL 4 | Concealed electric through-wire (2 wires @ 20ga, 2 wires @ 26ga) | \$475.00 |
| | | | EL 8 | Concealed electric through-wire (8 wires, 28ga) | \$550.00 |

Accessories

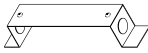
| PART | DESCRIPTION | LIST PRICE |
|---|-------------------------------------|------------|
|  85004 | MORTAR GUARD FOR ELECTRIFIED HINGES | \$80.00 |



Privacy Latches
SEE PAGE 228



Flush and Surface Bolts
SEE PAGE 229



Coordinators
SEE PAGE 232



Push Plates
SEE PAGE 235



Pulls and Pull Plates
SEE PAGE 237

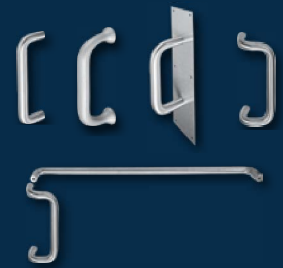

Push and Push-Pull Bars
SEE PAGE 244

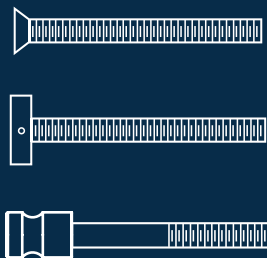

Fasteners
SEE PAGE 246

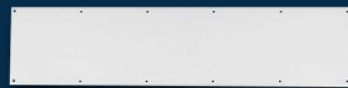

Door Protection Plates
SEE PAGE 248

Great Solution for Hospitality and Dormitories



Features





- Perfect for situations with hall-to-room openings, such as, hotels, student housing or apartments.
- Prevents accidental lock out from the conventional flip-latch.
- Allows the door to be opened for identification while providing privacy for the guest or resident.
- Keeps guest from (illegally) propping open entry fire doors.
- Does not allow the door to be held open, avoiding door and frame damage.
- Meets the requirements of FPPA 80 Sections 5.2.4.2 and 5.2.13.3 that requires auxiliary hardware does not interfere or prohibit the proper operation of fire rated doors, and that doors are not blocked or wedged in the open position.
- Easy to install, fast retrofit.
- ADA Compliant.
- Simple to operate for guest or residents.







| MODEL | DESCRIPTION | LIST PRICE 626 |
|-------|--------------------|-------------------|
| 579 | Privacy Door Latch | \$58.00 |



Flush Bolts - Manual

| MODEL (SPECIFY FUNCTION) | DESCRIPTION | LIST PRICE | | |
|---|--|------------|---------|-----|
| | | 605 | 613 | 626 |
| HOLLOW METAL DOOR | | | | |
|  93170 | Flush Bolt, ANSI Type L04251 (1 ea) | | \$40.00 | |
| COMPOSITE WOOD DOORS | | | | |
|  93270 | Flush Bolt, ANSI Type L04261 (1 ea) | | \$48.00 | |

Flush Bolts - Automatic

| MODEL (SPECIFY FUNCTION) | DESCRIPTION | LIST PRICE | | |
|---|---|------------|----------|-----|
| | | 605 | 613 | 626 |
| HOLLOW METAL DOOR | | | | |
|  93101 | Flush Bolts, ANSI Type 25 (Included as a Pair) | | \$250.00 | |
|  93102 | Flush Bolts - Push Button Release, ANSI Type 27 (Included as a Pair) | | | |
|  93103 | Flush Bolt - with Fire Pin, ANSI Type L04021 (Included as a Pair) | | | |
| COMPOSITE WOOD DOORS | | | | |
|  93201 | Flush Bolts, ANSI Type 25 (Included as a Pair) | | \$265.00 | |
|  93202 | Flush Bolts - Push Button Release, ANSI Type 27 (Included as a Pair) | | | |
|  93203 | Flush Bolt - with Fire Pin, ANSI Type L04021 | | | |

FLUSH BOLTS

LIST PRICE

Accessories

Effective July 3, 2023

| MODEL (SPECIFY FUNCTION) | DESCRIPTION | LIST PRICE | | |
|--|--|------------|----------|-----|
| | | 605 | 613 | 626 |
|  99101 | Includes 93101 Series Automatic Flush Bolt, for Metal Doors (Specify Finish) (1 each) | | \$140.00 | |
|  99102 | Includes 93102 Series Top Flush Bolt w/Push Button Release (Specify Finish) (1 each) | | | |
|  99201 | Includes 93201 Series Flush Bolt for Wood Doors (Specify Finish) (1 each) | | \$150.00 | |
|  99202 | Includes 93202 Series Top Flush Bolt w Push Button Release for Wood Doors (Specify Finish) (1 each) | | | |
|  909 | Dust Proof Strike (Specify Finish), (1 each) | | \$42.00 | |
|  629030 | Fire Pin for Hollow Metal Doors and Composite Wood Doors ¹ , (1 each) | | \$66.00 | |
|  93170E | 24" Extension Rod for 93170 Series Manual Flush Bolts, (1 each) | | \$15.00 | |

Notes: 1 - For fire labeled doors, must be used with PDQ UL fire listed automatic flush bolts to maintain UL listing status and fire code compliance.

Cross Reference



| | PDQ | ABH | DCI | HAGER | IVES | ROCKWOOD | TRIMCO |
|------------------|------------------------------|-------|----------|-------|-------|----------|------------|
| DOOR TYPE | MANUAL FLUSH BOLTS | | | | | | |
| HOLLOW METAL | 93170 | 1855S | 780F | 282D | FB458 | 555 | 3917-12 |
| COMPOSITE WOOD | 93270 | 1875S | 790F | 283D | FB358 | 557 | 3913 |
| DOOR TYPE | AUTOMATIC FLUSH BOLTS | | | | | | |
| HOLLOW METAL | 93101 | 1860P | 842 | 292D | FB31P | 2842 | 3810x3810 |
| | 93102 | — | 845 | 293D | FB51P | 2845 | 3820x3810 |
| | 93103 | — | 805/8BFB | 295M | FB52 | 2848 | 3820x3850 |
| COMPOSITE WOOD | 93201 | 1862P | 942 | 291D | FB41P | 2942 | 3815x3815L |
| | 93202 | — | 945 | 293D | FB61P | 2945 | 3825x3815L |
| | 93203 | — | 960/9BFB | 295W | FB42 | 2948 | 3815x3850 |

SURFACE BOLTS

LIST PRICE

Effective July 3, 2023

Surface Bolts

| MODEL | DESCRIPTION | LIST PRICE |
|---|--|------------|
|  460 626 | Surface Bolt - 8" (Includes Top and Bottom Strikes) | \$35.00 |
|  461 626 | Surface Bolt - 12" (Includes Top and Bottom Strikes) | \$42.00 |
|  462 626 | Surface Bolt - 8" Concealed Anti-Vandal Mounting (Includes Top and Bottom Strikes) | |



ANSI Type 21A Coordinators



Features

- Non-handed.
- Override protection to prevent damage in case of abnormal force on door
- Mechanism and filler bar completely fill width of opening
- Suitable for painting to match door and frame finish



Specifications

| | |
|---|--|
| BASE MATERIAL: | • Steel |
| FASTENERS: | • 8 Ea. 12-24 x 1-1/4 PH MS. • 6 Ea. #8 x 3/4" Combo Screws. • Strike Plates. |
| FINISHES: | • 600 (USP) primer |
| COORDINATOR SIZES: | • COR42: 1-5/8" x 5/8"H x 42L" • COR52: 1-5/8" x 5/8"H x 52L" • COR60: 1-5/8" x 5/8"H x 60L" |
| CERTIFICATIONS, LISTINGS, COMPLIANCES: | • UL listed for 3 hours for use with a pair of swing doors incorporating an astragal • Complies with ANSI/BHMA156.3 Type 21A • TAA compliant. Country of origin: Taiwan |

How to Select the Right Size Coordinator

| DOOR OPENING WIDTH | MODEL NUMBER | COORDINATOR PART NUMBER | COORDINATOR LENGTH | FILLER PART NUMBER | FILLER LENGTH |
|--------------------|--------------|-------------------------|--------------------|--------------------|---------------|
| 48"-54" | COORD54 | COR42 | 42" | FB18 | 18" |
| 55"-60" | COORD60 | COR52 | 52" | FB18 | 18" |
| 61"-72" | COORD72 | COR52 | 52" | FB20 | 20" |
| 73"-96" | COORD96 | COR60 | 60" | FB36 | 36" |

Coordinator size and length is a function of the active door size. It is recommended the coordinator extend a min of 6" beyond the active door width.

EXAMPLES:

- 1 — Active door with astragal = 48", inactive door = 48".
Recommended Coordinator Model: COORD96
- 2 — Active door with astragal = 36", inactive door = 36".
Recommended Coordinator Model: COORD72
- 3 — Active door with astragal = 36", inactive door = 24".
Recommended Coordinator Model: COORD60

NOTE: If stop height dimension is other than 58" contact PDQ Technical Service

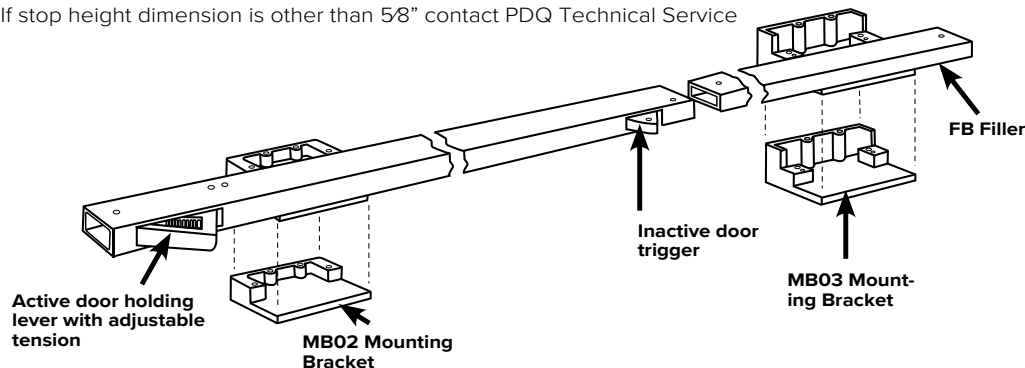
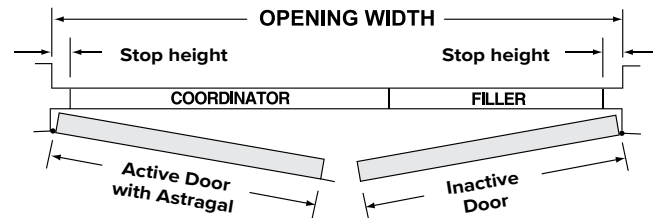

How to Order

| DOOR OPENING WIDTH | MOUNTING BRACKET OPTION | FINISH |
|--|--|--|
| <p>COORD72</p> <p>COORD 54 — For Door Widths From 48" - 54" COORD 60 — For Door Widths From 55" - 60" COORD 72 — For Door Widths From 61" - 72" COORD 96 — For Door Widths From 73 - 96"</p> | <p>MB02</p> <p>MB02 — Mounting Bracket - Soffit over 2-1/4" MB03 — Mounting Bracket - Soffit 7/8" - 2-1/4"</p> | <p>600</p> <p>600 — USP Primer</p> |

Ordering Example Door Opening Width: 72", Soffit width: 7/8": **COORD 72 MB03 600**

| MODEL | DESCRIPTION | LIST PRICE 600 |
|---|--|-------------------|
|  | COORD 54 Door Coordinator, for door widths from 48" - 54" (Includes 1ea FB18 18" Filler Bar) | \$240.00 |
| | COORD 60 Door Coordinator, for door widths from 55" - 60" (Includes 1ea FB18 18" Filler Bar) | \$268.00 |
| | COORD 72 Door Coordinator, for door widths from 61" - 72" (Includes 1ea FB20 20" Filler Bar) | |
| | COORD 96 Door Coordinator, for door widths from 73 - 96" (Includes 1ea FB36 36" Filler Bar) | \$275.00 |



Options

| | CODE | DESCRIPTION | COORDINATOR ADJUSTMENT |
|---|------|---|---------------------------|
|  | MB02 | Mounting Bracket - Soffit over 2-1/4" (Included as pair) | \$75.00 |
|  | MB03 | Mounting Bracket - Soffit 7/8" - 2-1/4" (Included as pair) | |

Accessories

| PART NUMBER | DESCRIPTION | LIST PRICE 600 |
|-------------|---|-------------------|
| COR42 600 | COR42 Door Coordinator, 42", ANSI type 21A | \$195.00 |
| COR52 600 | COR52 Door Coordinator, 52", ANSI Type 21A | \$210.00 |
| COR60 600 | COR60 Door Coordinator, 60", ANSI type 21A | \$220.00 |
| FB18 600 | FB18 - Filler 18" | \$28.00 |
| FB20 600 | FB20 - Filler 20" | \$32.00 |
| FB36 600 | FB36 - Filler 36" | \$40.00 |

Accessories

| MODEL | DESCRIPTION | LIST PRICE | | |
|---|--|------------|---------|-----|
| | | 626 | 689 | 695 |
|  910 | Carry Bar (Specify finish) | — | \$50.00 | |
|  | 93590 Gravity Coordinator, 6-1/2", ANSI Type 21B | \$176.00 | — | — |
| | 93591 Gravity Coordinator, 8-1/2", ANSI Type 21B | | — | — |

Cross Reference

| PDQ | DESCRIPTION | ABH | DCI | HAGER | IVES | ROCKWOOD | TRIMCO |
|-------------|---------------------|------|-------|-------|----------|----------|--------|
| COR54 | Coordinator | 3710 | N6 | 297D | COR32 | 2660 | 3094A2 |
| COR60/72 | Coordinator | 3720 | 6 | 297D | COR42/52 | 2672 | 3094B1 |
| COR96 | Coordinator | 3730 | L-6 | 297D | COR60/72 | 2696 | 3094C4 |
| MB03 | Mounting Bracket | 3751 | 601AB | 297M | MB-2 | 1601AB | 3095 |
| MB02 | Mounting Bracket | 3752 | 601C | 297N | MB-1 | 1601C | 3096 |
| 910 | Carry Bar | 3760 | 100 | 297C | CB1 | 1100 | 3090 |
| 93590/93591 | Gravity Coordinator | 3790 | 500 | 298D | COR7G | 576 | 3093 |

Specifications



| | |
|---------------------------------------|--|
| MOUNTING FASTENERS: | • #6 x 5/8 OH PH SMS |
| MATERIAL: | • Brass, Stainless Steel for 605, 606, 612, 613E, and 630 finishes |
| THICKNESS: | • 0.050" |
| STANDARD CUTOUT FOR CYLINDER: | • 1-1/4" DIA |
| STANDARD CUTOUT FOR THUMBTURN: | • 3/8" DIA |
| FINISHES: | <ul style="list-style-type: none"> • 605 (US3) Bright Brass, 606 (US4) Satin Brass, 612 (US10) Satin Bronze, 613E Dark Oxidized Satin Bronze, 628 (US28) Aluminum - Anodized, 630 US32D) Satin Stainless Steel • Antimicrobial Coating available on 630 (US32D) only |

Plates are available with optional cutout for cylinders or thumbturns

OPTIONS FOR LOCKING HARDWARE

PREPS FOR THUMBTURNS

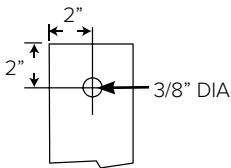

962/963 SERIES RH
RIGHT HAND SHOWN

PREPS FOR CYLINDERS

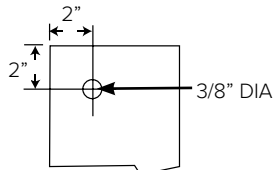
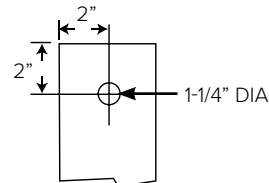

965/966 SERIES RH
RIGHT HAND SHOWN

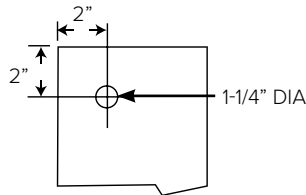

HANDING

IN SWING DOOR

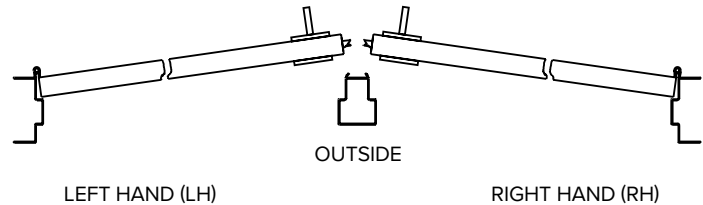

OUT SWING DOOR

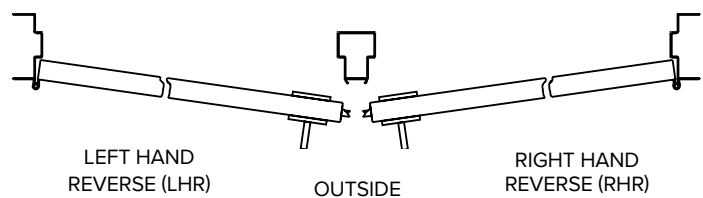

PULL POSITIONING

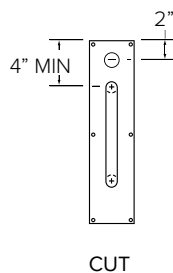
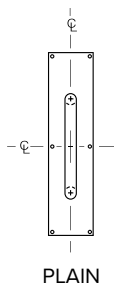

RECOMMENDED MOUNTING LOCATIONS

Note: Complies with ADA (Americans with Disabilities Act) Guidelines

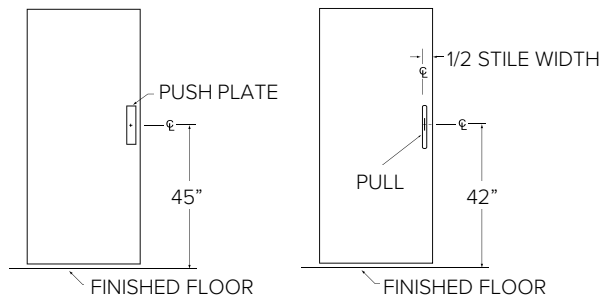

How to Order

| QUANTITY | SERIES | PLATE THICKNESS | SIZE | FINISH | HANDING | OPTIONS |
|------------------------------------|--------|-----------------|--|---|-----------------------------------|---|
| 10 | 9 | 6 | 2 | 630 | RH | — |
| Ordering Example: 9 6 2 630 | | 6 — .050" | 2 — 3-1/2" X 15" 3 — 4" X 16" 5 — 6" X 16" * 6 — 8" X 16" * | 605 — Bright Brass 606 — Satin Brass 612 — Satin Bronze 613E — Dark Oxidized Satin Bronze 628 — Satin Aluminum, Anodized 630 — Satin Stainless Steel | RH — Right Hand LH — Left Hand | CTC PREP B — 5-1/2" CTC C — 6" CTC D — 8" CTC E — 10" CTC F — 12" CTC PREP FOR LOCKING HARDWARE C — Cylinder T — Thumbturn AM — Antimicrobial Coating |

* 630 Only

| MODEL (Specify Finish) | DESCRIPTION | LIST PRICE | | | | | |
|---------------------------|--|------------|-----|---------|-----|------|---------|
| | | 630 | 605 | 606 | 612 | 613E | 628 |
| 962 | Push Plate 0.050" thick x 3-1/2"W x 15"H | \$20.00 | | \$40.00 | | | \$20.00 |
| 963 | Push Plate 0.050" thick x 4"W x 16"H | \$30.00 | | \$50.00 | | | \$30.00 |
| 965 | Push Plate 0.050" thick x 6"W x 16"H | \$40.00 | | | — | | |
| 966 | Push Plate 0.050" thick x 8"W x 16"H | \$50.00 | | | — | | |

Options

| CODE | DESCRIPTION | PLATE ADJUSTMENT |
|---|---|------------------|
| Prep for Locking Hardware | | |
| T | Thumbturn Prep | \$8.00 |
| C | Cylinder Prep | |
| CTC Thurbolt Prep (For pull plate on opposite side) | | |
| CTC-B | 5-1/2" CTC (Center to Center) | \$8.00 |
| CTC-C | 6" CTC | |
| CTC-D | 8" CTC | |
| CTC-E | 10" CTC | |
| CTC-F | 12" CTC | |
| AM | Antimicrobial protected coating applied to tactile surfaces | \$22.00 |

Notes:

1 - Handing required for Plate Size 5 and 6. 2 - Cylinder and Thumbturn Prep not available in Plate Size 2.











Specifications

| | |
|--------------------------|--|
| MOUNTING OPTIONS: | • Varies by product, see specific product details. |
| SIZES: | • Varies by product, see specific product details. |
| FINISHES: | <ul style="list-style-type: none"> • 605 (US3) Bright Brass, 606 (US4) Satin Brass, 612 (US10) Satin Bronze, 613E Dark Oxidized Satin Bronze, 628 (US28) Aluminum - Anodized, 630 US32D) Satin Stainless Steel, see specific product for finish availability • Antimicrobial Coating available on 630 (US32D) only |

How to Order

| PULL | FINISH | MOUNTING | OPTIONS |
|--|--|---|--|
| 2C See Models Below Ordering Example, Standard Mount: 2C 630 1 Notes: 1 - See mounting options located on Page 239. 2 - For Mounting Option List Price Adds, see Page 246. | 630 605 — Bright Brass 606 — Satin Brass 612 — Satin Bronze 613E — Dark Oxidized Satin Bronze 626 — Satin Chrome 628 — Satin Aluminum, Anodized 630 — Satin Stainless Steel | 1 SINGLE 1 — TYPE 1 (DEFAULT) Thru Bolt for Metal, Composite or Wood Door 6 — TYPE 6 Surface Concealed for Metal Door (Door Reinforcement by Others) 6R — TYPE 6R Surface Concealed for Metal Door (Rivnut) 8 — TYPE 8 Surface Concealed for Wood Door (Knife Thread Insert) 12 — TYPE 12 Thru Bolt for Metal, Composite or Wood Door, Decorative Head 15 — TYPE 15 Thru Bolt for Glass Door, Decorative Head BACK TO BACK 5 — TYPE 5 (DEFAULT) Back to Back for Metal or Wood Door 13 — TYPE 13 Back to Back for Glass Door | — AM — Antimicrobial Coating |

Straight Pulls

| MODEL | DESCRIPTION | LIST PRICE | | | | | |
|---|-------------------------------------|------------|-----|----------|-----|----------|---------|
| | | 630 | 605 | 606 | 612 | 613E | 628 |
|  1B | 5/8" Round Straight Pull 5-1/2" CTC | \$30.00 | | \$60.00 | | | \$20.00 |
|  2C | 3/4" Round Straight Pull 6" CTC | \$40.00 | | \$70.00 | | | \$30.00 |
|  2D | 3/4" Round Straight Pull 8" CTC | \$50.00 | | \$80.00 | | | \$40.00 |
|  3D | 1" Round Straight Pull 8" CTC | \$70.00 | | \$100.00 | | | \$40.00 |
|  H3D | 1" Round Straight Pull 8" CTC ADA | \$78.00 | — | \$108.00 | — | \$108.00 | — |
|  H3E | 1" Round Straight Pull 10" CTC ADA | \$85.00 | — | — | — | — | — |
|  H3F | 1" Round Straight Pull 12" CTC ADA | \$94.00 | — | — | — | — | — |
|  5C | 1" Flat Straight Pull 6" CTC | \$68.00 | | \$98.00 | | | \$38.00 |
|  5D | 1" Flat Straight Pull 8" CTC | \$78.00 | | \$108.00 | | | \$48.00 |

For Mounting Options, see Page 239

Cast Pulls

| MODEL | DESCRIPTION | LIST PRICE | | | | |
|--|----------------------|------------|-----|-----|------|-----|
| | | 605 | 606 | 612 | 613E | 628 |
|  11 | Cast Pull 5-1/2" CTC | \$38.00 | | | | |



| MODEL | DESCRIPTION | LIST PRICE | | |
|--|--------------------------------------|------------|-----|------|
| | | 626 | 605 | 613E |
|  12 | Cast Pull, Surface Mount, 5-1/2" CTC | \$58.00 | | |

Offset Pull

| MODEL | DESCRIPTION | LIST PRICE 630 |
|--|--------------------------------------|-------------------|
|  9E | 1" Round Offset Pull Handle, 10" CTC | \$175.00 |

For Mounting Options, see Page 239

Back to Back Pulls

| MODEL | DESCRIPTION | LIST PRICE | | | | |
|--|--|------------|----------|-----|-----|------|
| | | 630 | 605 | 606 | 612 | 613E |
|  22C 22D | 3/4" Round Straight BTB Pull 6" CTC | \$95.00 | \$125.00 | | | |
| | 3/4" Round Straight BTB Pull 8" CTC | \$110.00 | \$140.00 | | | |
| H33D | 1" Round Straight BTB Pull 8" CTC ADA | \$200.00 | - | | | |
|  H33E H33F | 1" Round Straight BTB Pull 10" CTC ADA | \$220.00 | - | - | - | - |
| | 1" Round Straight BTB Pull 12" CTC ADA | \$245.00 | - | | | |
| 99E | 1" Round Offset Pull Handle, 10" CTC | \$320.00 | - | | | |

For Mounting Options, see Page 239

Options

| CODE | DESCRIPTION | PULL ADJUSTMENT |
|------|---|-----------------|
| AM* | Antimicrobial coating applied to tactile surfaces | \$30.00 |

*Notes: - - 6 piece minimum required. Can be a mix of different products. - Orders with less than 6 pieces need to be quoted and the list price add adjusted. - Allow 2-3 weeks for delivery.

MOUNTING OPTIONS: PULLS

LIST PRICE

Effective July 3, 2023

Thru Bolt

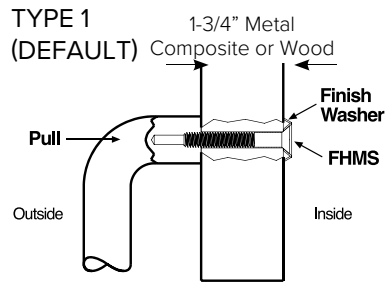

| CODE | PULL ADJUSTMENT |
|------|-----------------|
| 1 | N/C |

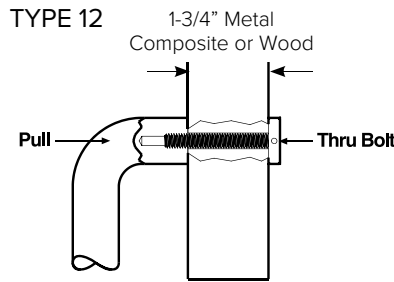

| CODE | PULL ADJUSTMENT |
|------|-----------------|
| 12 | \$27 |

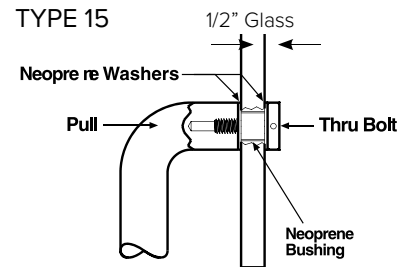

| CODE | PULL ADJUSTMENT |
|------|-----------------|
| 15 | \$27 |

Surface Concealed

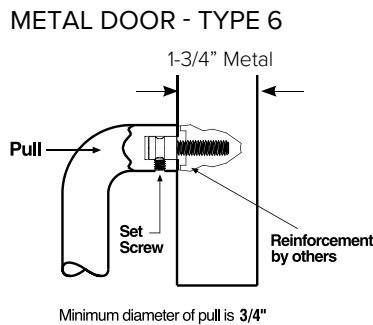

| CODE | PULL ADJUSTMENT |
|------|-----------------|
| 6 | \$16 |

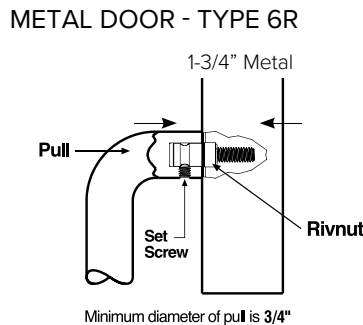

| CODE | PULL ADJUSTMENT |
|------|-----------------|
| 6R | \$18 |

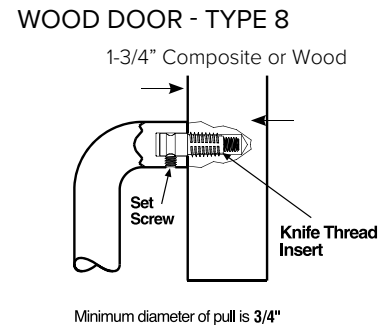

| CODE | PULL ADJUSTMENT |
|------|-----------------|
| 8 | \$18 |

Back to Back

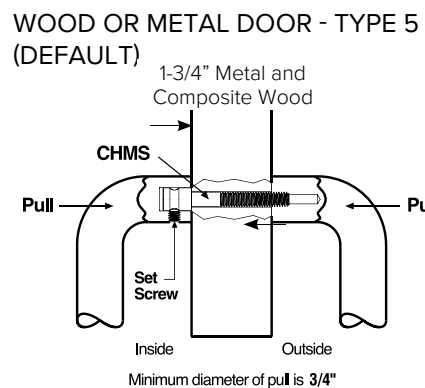

| CODE | PULL ADJUSTMENT |
|------|-----------------|
| 5 | N/C |

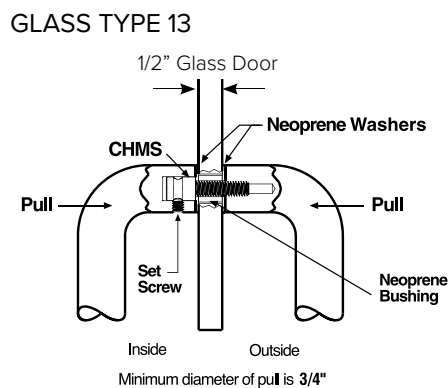

| CODE | PULL ADJUSTMENT |
|------|-----------------|
| 15 | \$13 |

MOUNTING OPTIONS: PULLS

LIST PRICE

Effective July 3, 2023

Pull Mounting Quick Reference Guide

| PULL TYPE | DESCRIPTION | MOUNTING OPTIONS | | | | | | | |
|-----------|---|------------------|---|---|------|---|----|----|----|
| | | HD* | 1 | 5 | 6/6R | 8 | 12 | 13 | 15 |
| 1B | 5/8" Round Straight Pull 5-1/2" CTC | | • | | | | • | | • |
| 2C | 3/4" Round Straight Pull 6" CTC | | • | | • | • | • | | • |
| 22C | 3/4" Round Straight BTB Pull 6" CTC | | | • | | | | • | |
| 2D | 3/4" Round Straight Pull 8" CTC | | • | | • | • | • | | • |
| 22D | 3/4" Round Straight BTB Pull 8" CTC | | | • | | | | • | |
| 3D | 1" Round Straight Pull 8" CTC | • | • | | • | • | • | | • |
| 33D | 1" Round Straight BTB Pull 8" CTC | • | | | | | | | |
| H3D | 1" Round Straight Pull 8" CTC ADA | • | • | | • | • | • | | • |
| H33D | 1" Round Straight BTB Pull 8" CTC ADA | • | | • | | | | • | |
| H3E | 1" Round Straight Pull 10" CTC ADA | • | • | | • | • | • | | • |
| H33E | 1" Round Straight BTB Pull 10" CTC ADA | • | | • | | | | • | |
| H3F | 1" Round Straight Pull 12" CTC ADA | • | • | | • | • | • | | • |
| H33F | 1" Round Straight BTB Pull 12" CTC ADA | • | | • | | | | • | |
| 5C | 1" 1/2 Round Straight Pull 6" CTC | • | • | | | | • | | |
| 5D | 1" 1/2 Round Straight Pull 8" CTC | • | • | | | | • | | |
| 9E | 1" Round Offset Pull Handle 10" CTC | • | • | | • | • | • | | • |
| 99E | 1" Round Offset Pull Handle BTB 10" CTC | • | | | | | | • | |
| 11 | Cast Pull 5-1/2" CTC | | • | | | | • | | |

*HD Designation indicates 5/16" fasteners for 1 inch diameter pulls

PULL PLATES

LIST PRICE

Effective July 3, 2023



Specifications

| | |
|----------------------------------|---|
| PLATE SIZES: | • Varies by product, contact PDQ Customer Service for details. |
| PULL SERIES: | • Varies by product, see specific product details. |
| THICKNESS: | • 0.050" |
| PLATE MOUNTING FASTENERS: | • #6 X 5/8 CH PH SMS |
| FINISHES: | <ul style="list-style-type: none"> • 605 (US3) Bright Brass, 606 (US4) Satin Brass, 612 (US10) Satin Bronze, 613E Dark Oxidized Satin Bronze, 628 (US28) Aluminum - Anodized, 630 (US32D) Satin Stainless Steel • Antimicrobial Coating available on 630 (US32D) only |





How to Order

| QUANTITY | SERIES | PLATE | PULL | FINISH | PREP FOR LOCKING HARDWARE ^{1,2} | HANDING ¹ | MOUNTING ³ |
|---|--------|--|--|---|---|---|---|
| 10 | 86 | 3 | 2D | 630 | T | RH | 1 |
| Ordering Examples: Standard mount for Metal Door: 86 3 2D 630 1 Notes: 1 - Handing required for Plate Size 5, 6 2 - Cylinder and Thumbturn Prep not available in Plate Size 5 3 - For Mounting Options, see Page 239 4 - For Mounting Option List Price Adds, see Page 246 | | 2 — 3-1/2" X 15" 3 — 4" X 16" 5 — 6" X 16" (630 ONLY) 6 — 8" X 16" (630 ONLY) | 1B — 5/8" Round Straight Pull 5-1/2" CTC 2C — 3/4" Round Straight Pull 6" CTC 2D — 3/4" Round Straight Pull 8" CTC 3D — 1" Round Straight Pull 8" CTC H3D — 1" Round Straight Pull 8" CTC ADA H3E — 1" Round Straight Pull 10" CTC ADA H3F — 1" Round Straight Pull 12" CTC ADA 5C — 1" Round Straight Pull 6" CTC 5D — 1" Round Straight Pull 8" CTC 11 — Cast Pull 5-1/2" CTC | 605 — Bright Brass 606 — Satin Brass 612 — Satin Bronze 613E — Dark Oxidized Satin Bronze 628 — Satin Aluminum, Anodized 630 — Satin Stainless Steel | C — Cylinder T — Thumbturn | RH — Right Hand LH — Left Hand | 1 — TYPE 1 Thru Bolt for Metal, Composite or Wood Door (Default) 6 — TYPE 6 Surface Concealed for Metal Door (Door Reinforcement by Others) 6R —TYPE 6R Surface Concealed for Metal Door (Rivnut) 8 — TYPE 8 Surface Concealed for Wood Door (Knife Thread Insert) 12 — TYPE 12 Thru Bolt for Metal, Composite or Wood Door, Decorative Head |

PULLS AND PULL PLATES

LIST PRICE

Effective July 3, 2023

| SERIES | PLATE | PULL | DESCRIPTION | LIST PRICE | | |
|--------|---|------|--|------------|--------------------------|---------|
| | | | | 630 | 605/606/612/613E | 628 |
| 862 |  3-1/2" x 15" (Ref 962 Series Push Plate) | 1B | 5/8" Round Straight Pull 5-1/2" CTC | \$57.00 | \$107.00 | \$27.00 |
| | | 2C | 3/4" Round Straight Pull 6" CTC | \$65.00 | \$115.00 | \$35.00 |
| | | 2D | 3/4" Round Straight Pull 8" CTC | \$70.00 | \$120.00 | \$40.00 |
| | | 3D | 1" Round Straight Pull 8" CTC | \$105.00 | \$155.00 | \$75.00 |
| | | H3D | 1" Round Straight Pull 8" CTC | \$113.00 | \$163.00 (606/613E Only) | — |
| | | 5C | 1" Flat 1/2 Round Straight Pull 6" CTC | \$97.00 | \$147.00 | \$67.00 |
| | | 5D | 1" Flat 1/2 Round Straight Pull 8" CTC | \$108.00 | \$158.00 | \$78.00 |
| | | 11 | Cast Pull 5-1/2" CTC | \$56.00 | \$106.00 | \$26.00 |
| 863 |  4" x 16" (Ref 963 Series Push Plate) | 1B | 5/8" Round Straight Pull 5-1/2" CTC | \$62.00 | \$112.00 | \$32.00 |
| | | 2C | 3/4" Round Straight Pull 6" CTC | \$70.00 | \$120.00 | \$40.00 |
| | | 2D | 3/4" Round Straight Pull 8" CTC | \$80.00 | \$130.00 | \$50.00 |
| | | 3D | 1" Round Straight Pull 8" CTC | \$114.00 | \$164.00 | \$84.00 |
| | | H3D | 1" Round Straight Pull 8" CTC | \$122.00 | \$172.00 (606/613E Only) | — |
| | | H3E | 1" Round Straight Pull 10" CTC ADA | \$140.00 | — | — |
| | | H3F | 1" Round Straight Pull 12" CTC ADA | \$150.00 | — | — |
| | | 5C | 1" Flat 1/2 Round Straight Pull 6" CTC | \$104.00 | \$154.00 | \$74.00 |
| | | 5D | 1" Flat 1/2 Round Straight Pull 8" CTC | \$105.00 | \$155.00 | \$75.00 |
| | | 11 | Cast Pull 5-1/2" CTC | \$70.00 | \$120.00 | \$40.00 |
| 865 |  6"x16" (Ref 965 Series Push Plate) | 1B | 5/8" Round Straight Pull 5-1/2" CTC | — | — | — |
| | | 2C | 3/4" Round Straight Pull 6" CTC | \$77.00 | — | — |
| | | 2D | 3/4" Round Straight Pull 8" CTC | \$89.00 | — | — |
| | | 3D | 1" Round Straight Pull 8" CTC | \$120.00 | — | — |
| | | H3D | 1" Round Straight Pull 8" CTC | \$130.00 | — | — |
| | | H3E | 1" Round Straight Pull 10" CTC ADA | \$146.00 | — | — |
| | | H3F | 1" Round Straight Pull 12" CTC ADA | \$157.00 | — | — |
| | | 5C | 1" Flat 1/2 Round Straight Pull 6" CTC | \$109.00 | — | — |
| | | 5D | 1" Flat 1/2 Round Straight Pull 8" CTC | \$120.00 | — | — |
| | | 11 | Cast Pull 5-1/2" CTC | \$74.00 | — | — |
| 866 |  8"x16" (Ref 866 Series Push Plate) | 2D | 3/4" Round Straight Pull 8" CTC | \$98.00 | — | — |
| | | 3D | 1" Round Straight Pull 8" CTC | \$125.00 | — | — |
| | | H3D | 1" Round Straight Pull 8" CTC | \$135.00 | — | — |
| | | H3E | 1" Round Straight Pull 10" CTC ADA | \$154.00 | — | — |
| | | H3F | 1" Round Straight Pull 12" CTC ADA | \$165.00 | — | — |
| | | 5C | 1" Flat 1/2 Round Straight Pull 6" CTC | \$114.00 | — | — |
| | | 5D | 1" Flat 1/2 Round Straight Pull 8" CTC | \$125.00 | — | — |

For Mounting Options, see Page 239.

Options – Locking Hardware Prep

| CODE | DESCRIPTION | PULL PLATE ADJUSTMENT |
|------|---|-----------------------|
| T | Locking Hardware – Thumbturn Prep | \$8.00 |
| C | Locking Hardware – Cylinder Prep | |
| AM* | Antimicrobial protected coating applied to tactile surfaces | \$30.00 |

Note: 630 finish only, please place antimicrobial coated orders separately, and allow 30 days for manufacturing.

For additional product finishes or styles, please contact PDQ Technical Service.

91 00 33 Series Push Bar



How to Order

| QUANTITY | SERIES | PULL | PUSH BAR | FINISH | MOUNTING OPTIONS, PUSH BAR ONLY | MOUNTING OPTIONS, OFFSET PULL AND PUSH BAR SET |
|--|--------|--|--|---|--|---|
| 10 | 91 | 9E | 33 | 630 | — | S |
| Ordering Examples: Push Bar Only, Thru Bolt Mounting: 91 00 33 630 1HD Offset Pull Handle Push-Bar Set, Standard Mounting: 91 9E 33 630 S | | 00 — No Pull 3D — 1" Round Straight Pull 8" CTC H3D — 1" Round Straight Pull 8" CTC ADA H3E — 1" Round Straight Pull 10" CTC ADA H3FÆ — 1" Round Straight Pull 12" CTC ADA 9E — 1" Round Offset Pull Handle | XX — 1" Round Push Bar, Xx" CTC Example: 33 — 1" Round Push Bar, 33" CTC | 630 — Satin Stainless Steel 630AM — Satin Stainless Steel With Antimicrobial | 1 — Type 1 (Default) Thru Bolt For Metal, Composite Or Wood Door 6 — Type 6 Surface Concealed For Metal Door (Door Reinforcement By Others) 6R — Type 6R Surface Concealed For Metal Door (Rivnut) 8 — Type 8 Surface Concealed For Wood Door (Knife Thread Insert) 12 — Type 12 Thru Bolt For Metal, Composite Or Wood Door 15 — Type 15 Thru Bolt For Glass Door, Decorative Head | S — Standard (Default) D — Decorative M — Concealed For Metal Doors W — Concealed For Composite Or Wood Doors G — Decorative For Glass Doors |
| | | | | | SEE PAGE 245 FOR MOUNTING OPTION PRICING | |

Push Bars

| MODEL | DESCRIPTION | LIST PRICE 630 | PUSH BAR ADJUSTMENT |
|--------------|--------------------------------------|----------------|---------------------|
| 91 00 33 | 1" Round Push Bar, Including 33" CTC | \$320.00 | — |
| | 1" Round Push Bar, Over 33" CTC | | \$15.00 per inch |
| 91 91 33 | 1" Round Push Bar BTB | \$645.00 | \$30.00 per inch |

Push-Pull Bars

| MODEL | DESCRIPTION | LIST PRICE 630 |
|-----------------------|------------------------------------|-----------------------------------|
| 3D | 1" Round Straight Pull 8" CTC | \$105.00 |
| H3D H3E H3F | 1" Round Straight Pull 8" CTC ADA | \$115.00 |
| | 1" Round Straight Pull 10" CTC ADA | \$125.00 |
| | 1" Round Straight Pull 12" CTC ADA | \$135.00 |
| | 9E | 1" Round Offset Pull, 10" CTC ADA |

For Mounting Options, see Page 245

PUSH AND PUSH-PULL BARS

LIST PRICE

Effective July 3, 2023

Free End Details

Thru Bolt

TYPE 1

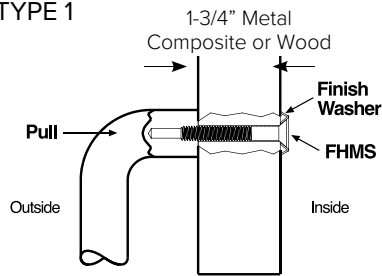

TYPE 12

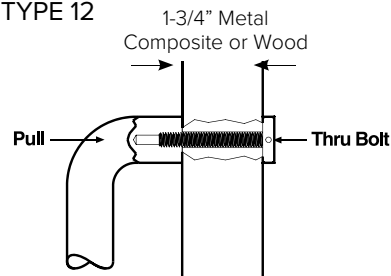

TYPE 15

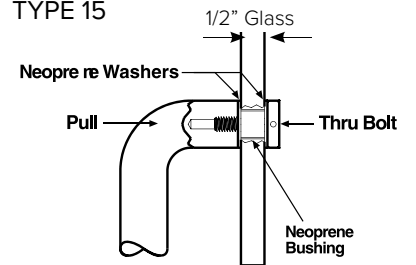

Surface Concealed

TYPE 6

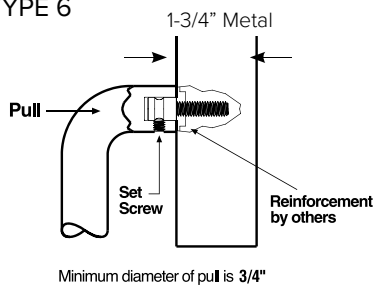

TYPE 6R

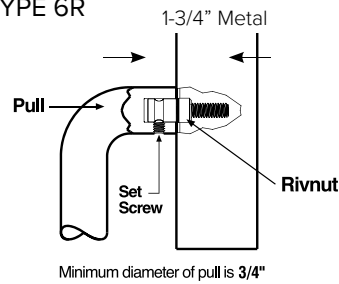

TYPE 8

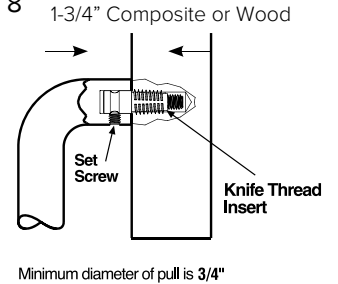

Common End Details

TYPE 5

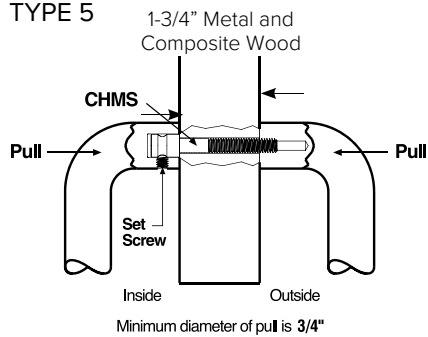

TYPE 13

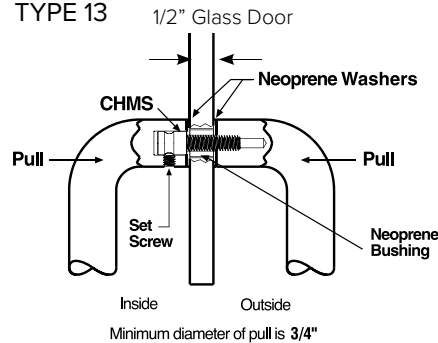

Note: For measurement details see brochure

Options – Mounting for Offset Pull Handles – Push Bar Sets

| TYPE | DESCRIPTION | MOUNTING TYPES | | ADJUSTMENT |
|------|---|----------------|----------|------------|
| | | COMMON END | FREE END | |
| S | Std Thru Bolt For 1-3/4" Metal, Composite or Wood Doors (Default) | 5 | 1 | N/C |
| D | Decorative Thru Bolt for 1-3/4" Metal, Composite or Wood Doors | 5 | 12 | \$30.00 |
| M | Concealed for 1-3/4" Metal Doors | 5 | 6 | \$25.00 |
| W | Concealed for 1-3/4" Composite or Wood Doors | 5 | 8 | \$30.00 |
| G | Decorative Thru Bolt for 1/2" Glass Doors | 13 | 15 | \$25.00 |

Screw Types

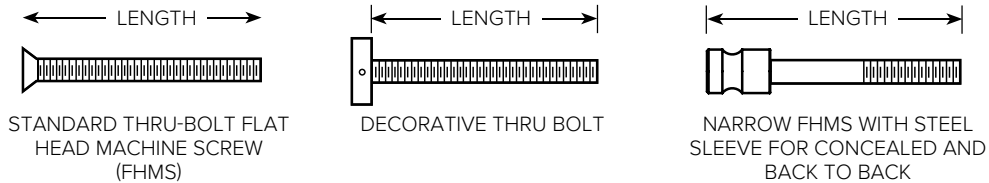

Fasteners for Door Pulls

Note: Fastener packs for 1-3/4" Steel and Composite Wood or 1/2" Thick Glass Doors. For other door thickness applications, contact PDQ Technical Service.

| PART NUMBER (Specify Finish) | OPTIONS, MOUNTING TYPE | DESCRIPTION | LIST PRICE 605, 613E, 630 | |
|---------------------------------|---------------------------|--|------------------------------|---------|
| 9001 | 1 | 2 ea. 1/4-20 x 2-1/4" FH MS, 2 ea. 1/4" Finish Washers. | \$8.00 | |
| | HD | 2 ea. 5/16-18 x 2-1/4 FH MS, 2 ea. 5/16" Finish Washers. | | |
| 9005 | 5W | 2 ea. 1/4-20 x 2-3/4" Undersize Head FH MS, 2 ea. 1/4-20 x 3/16" Set Screws, 2 ea. 1/4" x 1/2" Tapered Steel Sleeves, 2 ea. 1/4-20 x 1/2" Threaded Insert. | \$24.00 | |
| | HD | 2 ea. 5/16-18 x 2-3/4" Undersize Head FH MS, 2 ea. 1/4-20 x 1/4" Set Screws, 2 ea. 5/16" x 1/2" Steel Sleeves, 2 ea. 1/4-20 x 1/2" Threaded Insert. | | |
| 9006 | 6 | 2 ea. 1/4-20 x 1" Undersize Head FH MS, 2 ea. 2 ea. 1/4-20 x 3/16" Set Screws, 2 ea. 1/4" x 1/2" Tapered Steel Sleeves. | | |
| | HD | 2 ea. 5/16-18 x 1" Undersize Head FH MS, 2 ea. 1/4-20 x 1/4" Set Screws, 2 ea. 5/16" x 1/2" Tapered Steel Sleeves. | | |
| 9006R | 6R | 2 ea. 1/4-20 x 1-3/4" Undersize Head FH MS, 2 ea. 1/4-20 x 3/16" Set Screws, 2 ea. 1/4" x 1/2" Tapered Steel Sleeves, 2 ea. 1/4-20 Rivnut Inserts. | | |
| | HD | 2 ea. 5/16-18 x 1-5/8 Undersize Head FH MS, 2 ea. 1/4-20 x 1/4" Set Screws, 2 ea. 5/16" x 1/2" Tapered Steel Sleeves, 2 ea. 5/16-18 Rivnut Inserts | | |
| 9008 | 8 | 2 ea. 1/4-20 x 1-5/8" Undersize Head FH MS, 2 ea. 1/4-20 x 3/16" Set Screws, 2 ea. 1/4" x 1/2" Tapered Steel Sleeves, 2 ea. 1/4 - 20 Knife Thread Inserts | | |
| | HD | 2 ea. 5/16-18 x 1-5/8 Undersize Head FH MS, 2 ea. 1/4-20 x 3/16" Set Screws, 2 ea. 5/16" x 1/2" Tapered Steel Sleeves, 2 ea. 5/16 - 18 Knife Thread Inserts. | | |
| 9012 | 12 | 2 ea. 1" DIA Head, 1/4-20 x 2-1/4" Decorative Cap Bolts. | | \$34.00 |
| | HD | 2 ea. 1" DIA Head, 5/16-18 x 2-1/4" Decorative Cap Bolts. | | |
| 9013 | 13 | 2 ea. 1/4-20 x 1-3/4" Undersize Head FH MS, 2 ea. 1/4-20 x 3/16" Set Screws, 2 ea. 1/4" x 1/2" Tapered Steel Sleeves, 2 ea. Bushings for 1/2" Thick Glass Door, 4 ea. Neoprene Washer. | \$38.00 | |
| | HD | 2 ea. 5/16-18 x 1-3/4" Undersize Head FH MS, 4 ea. 1/4-20 x 1/4" Set Screws, 2 ea. 5/16" x 1/2" Tapered Steel Sleeves, 2 ea. Bushings for 1/2" Thick Glass Door, 4 ea. Neoprene Washers. | | |
| 9015 | 15 | 2 ea. 1" DIA Head 1/4-20 x 1-1/8" Decorative Cap Bolts, 2 ea. Neoprene Bushings for 1/2" Thick Glass Door, 4 ea. Neoprene Washers. | \$55.00 | |
| | HD | 2 ea. 1" DIA Head 1/4-20 x 1-1/8 Decorative Cap Bolts, 2 ea. Neoprene Bushings for 1/2" Thick Glass Door, 4 ea. Neoprene Washers. | | |

Ordering example: 9001 HD-630. . HD is for 1" pulls



Door Protection Plates

Types

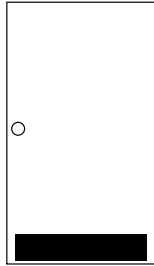

MOP PLATE
UP TO 6" H
X 48" W

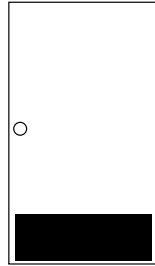

KICK PLATE
6" TO 12" H
X 48" W

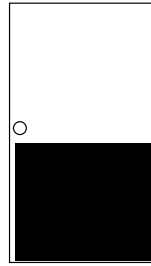

ARMOR PLATE
UP TO 48" H
X 48" W AND
AVAILABLE IN
MOST FINISHES

Features

- All PDQ door protection plates receive a light bevel in a secondary process to ensure a smooth edge.
- Provides protection for the bottom of the door from scuffing due to the foot traffic or cleaning maintenance.
- Recommended for all doors especially when using a door closer.
- Standard oval head undercut screws create a countersunk appearance.

Specifications

| | |
|----------------------------|---|
| MATERIAL: | • Stainless Steel |
| THICKNESS: | • 0.050" |
| MOUNTING FASTENERS: | • #6 x 5/8 OH PH SMS |
| FINISHES: | • 630 (US32D) Satin Stainless Steel, 613E , 622(US19) |

How to Order

| QUANTITY | SERIES | HEIGHT | WIDTH | FINISH |
|--------------------------|--------|----------------------------------|-----------------------------------|--|
| 10 | | 06 | 34 | 630 |
| Ordering Example: | | EXAMPLES: 06 — 6" 10 — 10" | EXAMPLES: 34 — 34" 35 — 35" | 613E — Bronze 622 — Flat Black 630 — Satin Stainless Steel |



Mop, Kick, and Armor Plates

| DIMENSIONS | 630 | 613E/622 |
|------------|----------|-----------|
| 6" x 34" | \$75.00 | \$94.00 |
| 8" x 34" | \$111.00 | \$139.00 |
| 10" x 34" | \$133.00 | \$166.00 |
| 12" x 34" | \$152.00 | \$190.00 |
| 32" x 34" | \$462.00 | \$578.00 |
| 34" x 34" | \$490.00 | \$613E.00 |
| 36" x 34" | \$550.00 | \$688.00 |
| 6" x 35" | \$88.00 | \$110.00 |
| 8" x 35" | \$115.00 | \$144.00 |
| 10" x 35" | \$139.00 | \$174.00 |
| 12" x 35" | \$172.00 | \$215.00 |
| 32" x 35" | \$473.00 | \$591.00 |
| 34" x 35" | \$520.00 | \$650.00 |
| 36" x 35" | \$578.00 | \$723.00 |



**Wall Stops
and Holders**



**Floor Stops
and Holders**



**Kick Down Door
Stops**



Hinge Stops



Roller Stops













**Roller Latches,
Catches and
Protectors**















**Hooks, Silencers,
Door Viewers and
Strikes**





Wall Stops and Holders

| MODEL (SPECIFY FUNCTION) | DESCRIPTION | QTY PER BOX | LIST PRICE | | | | | |
|---|---|----------------|------------|------|-----|---------|---------|-----|
| | | | 605 | 613E | 619 | 625 | 626 | 630 |
|  101 | Wall Stop - Convex Bumper ANSI Type L02101 | 50 | \$8.00 | | | | | |
|  102 | Wall Stop - Concave Bumper ANSI Type L02251 | 50 | | | | | | |
|  106 | Wall Stop - Adhesive Backed | 50 | \$3.00 | | | | | |
|  107 | Door Stop - Heavy Duty ANSI Type L02021 | 5 | \$32.00 | — | — | \$32.00 | — | |
|  108 | Door Stop - Heavy Duty with Keeper ANSI Type L01351 | 5 | \$42.00 | — | — | \$42.00 | — | |
|  109 | Door Stop ANSI Type L02031 | 5 | \$13.00 | — | — | — | \$13.00 | |
|  110 | Door Stop - Aluminum ANSI Type L02031 | 15 | \$8.00 | | | | | — |
|  112 | Door Stop - Spring Base ANSI Type L02051 | 100 | \$3.00 | | | — | — | — |
|  115 | Angled Wall Stop ANSI Type L02051 | 20 | — | — | — | — | \$55.00 | |
|  119 | Door Holder with Stop | 20 | — | — | — | — | \$80.00 | |

Floor Stops and Holders

| MODEL (SPECIFY FUNCTION) | DESCRIPTION | QTY PER BOX | LIST PRICE | | | |
|---|--|----------------|------------|---------|-----|---------|
| | | | 605 | 613E | 625 | 626 |
|  220 | Universal Dome Stop ANSI Type L02141 for plastic anchors ANSI Type L20161 for lead anchors | 20 | — | — | — | \$15.00 |
|  221 | Floor Stop - Low Dome ANSI Type L02141 | 50 | \$12.00 | | | |
|  222 | Floor Stop - High Dome ANSI Type L02061 | 50 | \$14.00 | | | |
|  223 | Floor Stop - Riser ANSI Type L02141 | 50 | — | — | — | \$6.00 |
|  224 | Floor Stop - Offset ANSI Type L02181 | 10 | — | \$28.00 | — | \$28.00 |
|  225 | Floor Stop - Offset ANSI Type L02181 | 10 | — | \$32.00 | — | \$32.00 |
|  226 | Floor Stop - Offset with Hold Open ANSI Type L01371 | 5 | — | | | |
|  227 | Floor Stop ANSI Type L02131 | 5 | \$34.00 | | — | \$34.00 |
|  228 | Floor Stop - with Keeper ANSI Type L01371 | 5 | \$36.00 | | — | \$36.00 |
|  229 | Stop ANSI Type L02131 | 10 | | | | |
|  230 | Stop ANSI Type L02131 | 10 | | | | |
|  231 | Floor Stop, Low Profile | 25 | \$18.00 | | — | \$18.00 |
|  232 | Floor Stop | 25 | \$20.00 | | — | \$20.00 |
|  233 | Floor Stop ANSI Type L02131 | 10 | — | — | — | |



Kick Down Door Stops

| MODEL (SPECIFY FINISH) | DESCRIPTION | QTY PER BOX | LIST PRICE | | | | |
|---|---------------------------------|-------------|------------|------|-----|---------|-----|
| | | | 605 | 613E | 626 | 689 | 695 |
|  240 | Kick Down - 4" ANSI Type L01382 | 10 | — | — | — | \$18.00 | |
|  241 | Kick Down - 5" ANSI Type L01382 | 10 | — | — | — | \$20.00 | |
|  242 | Kick Down - 4" ANSI Type L01382 | 10 | \$24.00 | | | — | — |
|  243 | Kick Down - 5" ANSI Type L01382 | 10 | \$32.00 | | | — | — |

Hinge Stops

| MODEL (SPECIFY FINISH) | DESCRIPTION | QTY PER BOX | LIST PRICE | | | | |
|---|----------------------------------|-------------|------------|------|-----|-----|-----|
| | | | 605 | 613E | 626 | 689 | 695 |
|  245 | Hinge Stop - 5" ANSI Type L02223 | 100 | \$6.00 | | | — | — |



Roller Stops

| MODEL (SPECIFY FINISH) | DESCRIPTION | QTY PER BOX | LIST PRICE | | | | |
|---|--------------------------------------|-------------|------------|------|-----|-----|-----|
| | | | 605 | 613E | 626 | 689 | 695 |
|  350 | Roller Stop, 4-1/2" ANSI Type L02191 | 10 | \$26.00 | | | — | — |
|  351 | Roller Stop, 6-1/2" ANSI Type L02201 | 10 | \$38.00 | | | — | — |
|  352 | Roller Stop, Curved ANSI Type L02211 | 10 | \$40.00 | | | — | — |



Roller Latches, Catches and Protectors

| MODEL (SPECIFY FINISH) | DESCRIPTION | QTY PER BOX | LIST PRICE | | | | |
|---|---|-------------|------------|------|---------|---------|-----|
| | | | 605 | 613E | 626 | 689 | 695 |
|  571 | Roller Latch with T Strike ANSI Type E09101 | 5 | \$32.00 | | | — | — |
|  572 | Roller Latch with ASA Strike | 5 | \$36.00 | | | — | — |
|  573 | Roller Latch with Full Lip Strike | 5 | | | | — | — |
|  574 | Roller Latch with Angle Stop ANSI Type E09111 | 10 | — | — | \$64.00 | — | — |
|  575 | Roller Latch with Strike | 10 | \$16.00 | | | — | — |
|  577 | Ball Catch Adjustable | 10 | | | | — | — |
|  578 | Door Guard | 10 | \$38.00 | | | — | — |
|  579 | Privacy Door Latch | 10 | — | | \$58.00 | — | — |
|  582 | Latch Protector | 20 | — | — | — | \$17.00 | |
|  583 | Latch Protector with 3-3/8" DIA Notched | 20 | — | — | — | | |
|  584 | 12" Interlock Latch Protector | 20 | — | — | — | \$14.00 | |

Hooks

| MODEL (SPECIFY FINISH) | DESCRIPTION | QTY PER BOX | FINISH N/A | LIST PRICE | | | |
|---|--|-------------|---------------|------------|------|-----|---------|
| | | | | 605 | 613E | 625 | 626 |
|  901 | Coat Hook - Medium ANSI Type L03111 | 10 | — | — | — | — | \$14.00 |
|  902 | Wardrobe Hook - Small ANSI Type L03111 | 10 | — | — | — | — | |



Silencers

| MODEL | DESCRIPTION | QTY PER BOX | LIST PRICE |
|---|---|-------------|------------|
|  904 | Silencer - Metal Doors (Must be ordered in multiples of 100.) ANSI Type L03011 | 100 | \$18.00 |
|  905 | Silencer - Wood Doors (Must be ordered in multiples of 100.) ANSI Type L03021 | 100 | |

Door Viewers

| MODEL (SPECIFY FINISH) | DESCRIPTION | QTY PER BOX | FINISH N/A | LIST PRICE | | |
|---|---|-------------|---------------|------------|------|-----|
| | | | | 605 | 613E | 626 |
|  906 | Door Viewer - 160 degrees UL ANSI Type 03222 | 25 | — | \$16.00 | | |

Strikes

| MODEL (SPECIFY FINISH) | DESCRIPTION | QTY PER BOX | FINISH N/A | LIST PRICE | | | |
|---|---|-------------|---------------|------------|------|-----|---------|
| | | | | 605 | 613E | 625 | 626 |
|  909 | Dust Proof Strike (Specify Finish), 1 each | — | — | \$42.00 | — | — | \$42.00 |
|  95572 | Strike, Roller Latch - ASA | 25 | — | \$16.00 | — | — | \$16.00 |
|  95673 | Strike, Roller Latch - Full Lip | 50 | — | | — | — | |



Sliding Barn Door Hardware



Architecturally Designed for Hospitality, Multi-Family and Commercial Applications.

Features

- Exclusive Soft Close stop design. Specify option SC.
- Max door weight: 220 lbs
- Nylon coated rollers
- Grade 304 Stainless Steel components
- Finish: 630 satin stainless steel

Specifications

| | |
|-------------------------------|--|
| CONFIGURATIONS: | <ul style="list-style-type: none"> • Single • Bi-parting |
| INSTALLATION: | <ul style="list-style-type: none"> • Side Wall Mount (only) |
| PERFORMANCE: | <ul style="list-style-type: none"> • Meets ANSI 156.14 Grade 1 Standard (100,000 cycles) |
| STANDARD KIT INCLUDES: | <ul style="list-style-type: none"> • 1 ea Track (specify length) • 2 ea Wall Brackets • 2 ea Track Stops • 2 ea Top Mount Hangers with Anti-jump pins • 1 ea Wood Guide • Installation fasteners |



Cross Reference

| PDQ | HAFELE | HAGER | PEMKO |
|----------------------------|------------------|-------------|-----------------------|
| STS SERIES | FLATEC II SERIES | 9432 SERIES | W60 SERIES |
| STS WITH SOFT CLOSE | N/A | N/A | W60 WITH CUSHION STOP |



SLIDING BARN DOOR HARDWARE — LIST PRICE

Effective July 3, 2023

How to Order

| QUANTITY | SERIES | DOOR MATERIAL | HANGER TYPE | TRACK (SPECIFY LENGTH) | FINISH | OPTIONS |
|----------|----------------------------|---------------|--------------------------------|--|-----------------------------|-----------------|
| 10 | STS | W | 171 | 78 | 630 | — |
| | STS — SLIDING TRACK SYSTEM | W — WOOD | 171 — TOP MOUNT, SINGLE ROLLER | 78 — 78-3/4" FOR 36" WIDE DOOR 98 — 98-7/16 " FOR 48" WIDE DOOR | 630 — SATIN STAINLESS STEEL | SC — SOFT CLOSE |







Ordering Examples: Kit for Wood Door: STS W 171 78 630 / Kit for Wood Door with Soft Close: STS W 171 78 630 SC

| MODEL | DESCRIPTION | LIST PRICE |
|------------------|---|------------|
| STS W 171 78 630 | Sliding Barn Door Hardware for 36" Wood Door, | \$615.00 |
| STS W 171 98 630 | Sliding Barn Door Hardware for 48" Wood Door, | \$690.00 |

Options

| CODE | DESCRIPTION | HARDWARE ADJUSTMENT |
|---------------------|---|---------------------|
| STS-W-171-78-630-SC | Soft Close (Extended lead time: Consult factory for lead times) | \$150.00 |
| STS-W-171-98-630-SC | Soft Close (Extended lead time: Consult factory for lead times) | |

Accessories

| PART NUMBER | DESCRIPTION | LIST PRICE |
|---|--|--------------|
| STSP17101-630  | STOP | \$22.00 each |
| STSP17103-630  | TOP MOUNT ROLLER HANGER. INCLUDES INSTALLATION FASTENERS. | \$90.00 each |
| STSP17104-630  | SOFT CLOSE ASSEMBLY | \$46.00 each |
| STSP17105-630  | SOFT CLOSE TRIGGER BRACKET. INCLUDES INSTALLATION FASTENERS. | \$18.00 each |
| STSP17106-630  | FLOOR GUIDE. INCLUDES INSTALLATION FASTENERS. | |
| STSP17107-630  | BI-PARTING CONNECTOR MATERIAL: GRADE 304 STAINLESS STEEL FINISH: 630 STAINLESS STEEL. MATCHES RAIL FINISH. "O" RINGS MAKE FOR EASY INSERTION INTO TRACK AND HELPS DAMPEN UNWANTED VIBRATION NOISE. | \$35.00 each |

Bi-Parting Solutions

FOR OPENINGS UP TO 4 FT WIDE:

- Requires: — 1ea STS Series Track Assy
- 2ea STSP17103-630 Roller Assemblies
- 2ea STSP7101-630 Stops
- 1ea STSP17106-630 Floor Guide

FOR OPENINGS OVER 4 FT WIDE:

- Requires: — 2ea STS Series Track Assys (specify size)
- 1ea STSP17107-630 Bi-parting Connector

BI-PARTING CONNECTOR

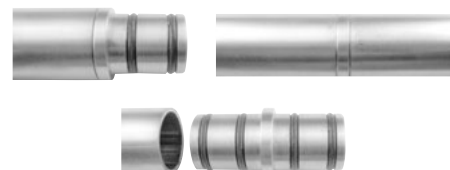

Note: Refer to Installation Instructions

Note: Refer to Installation Instructions

Master Key System Design

2- Levels of keying

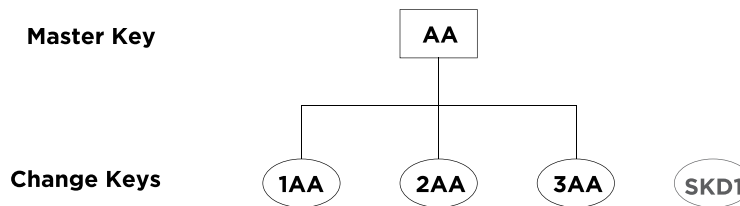

3- Levels of keying

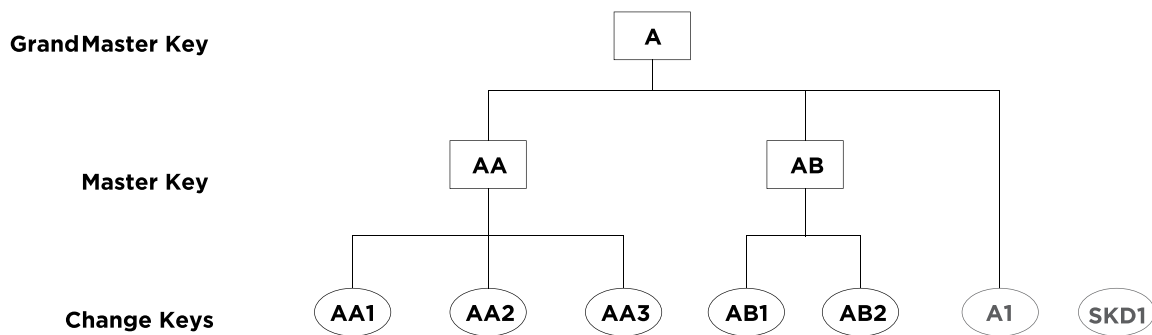

4- Levels of keying

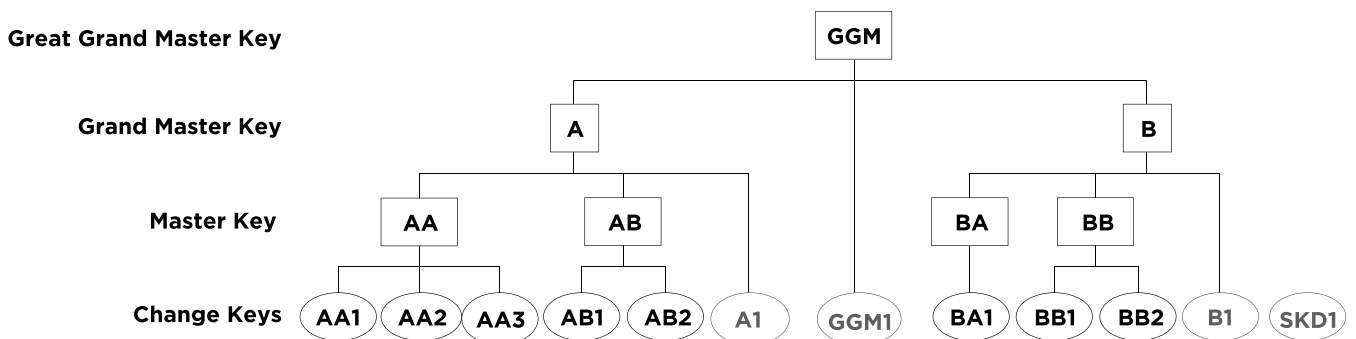

Master Key System Planning Form

| <p>Sold To: _____ Ship To: _____</p> <p>_____</p> <p>_____</p> <p>_____</p> | | <p>q Sheet 1 of _____</p> <p>q Date _____</p> <p>Purchase Order No. _____</p> | | | | | | | | | | | | | | | | | | | | | | | | | | | | | | | | | | | | | | | | | | | | | | | | | | | | | | | | |
|--|--|--|------------|------------------|-------|----------------|-------|----------------|-------|--------------|-------|-------|-------|-------|-------|-------|-------|-------|-------|--|--|-----|-----------------------|-------|--------------------------------|-------|-----------------------------------|-------|--|-----|----------------|-------|------------|-------|-----------------|-------|------------|-------|-----------------|-------|----------------|-------|-----------------|-------|-------------|-------|------------|-------|-------------|-------|------------|-------|------------|-------|-------------|-------|-------------|-------|
| <p>Job Name and Address:</p> <p>_____</p> <p>_____</p> <p>_____</p> <p>_____</p> <p>_____</p> | <p>Key Quantity:</p> <table style="width: 100%;"> <thead> <tr> <th></th> <th style="text-align: right;">Qty</th> </tr> </thead> <tbody> <tr><td>q G G G M</td><td style="text-align: right;">_____</td></tr> <tr><td>q G G M</td><td style="text-align: right;">_____</td></tr> <tr><td>q G G M</td><td style="text-align: right;">_____</td></tr> <tr><td>q G M</td><td style="text-align: right;">_____</td></tr> <tr><td>_____</td><td style="text-align: right;">_____</td></tr> <tr><td>_____</td><td style="text-align: right;">_____</td></tr> <tr><td>_____</td><td style="text-align: right;">_____</td></tr> <tr><td>_____</td><td style="text-align: right;">_____</td></tr> </tbody> </table> <p>MK/Group</p> <p>_____</p> <p>_____</p> <p>_____</p> <p>_____</p> <p>_____</p> | | Qty | q G G G M | _____ | q G G M | _____ | q G G M | _____ | q G M | _____ | _____ | _____ | _____ | _____ | _____ | _____ | _____ | _____ | <p>Change Keys:</p> <table style="width: 100%;"> <thead> <tr> <th></th> <th style="text-align: right;">Qty</th> </tr> </thead> <tbody> <tr><td>q Per Cylinder</td><td style="text-align: right;">_____</td></tr> <tr><td>q Per Keyed alike Group</td><td style="text-align: right;">_____</td></tr> <tr><td>q Per Keyed different cyl.</td><td style="text-align: right;">_____</td></tr> </tbody> </table> <p>Special Function</p> <table style="width: 100%;"> <thead> <tr> <th></th> <th style="text-align: right;">Qty</th> </tr> </thead> <tbody> <tr><td>Control</td><td style="text-align: right;">_____</td></tr> <tr><td>CMK</td><td style="text-align: right;">_____</td></tr> <tr><td>CMK Ctrl</td><td style="text-align: right;">_____</td></tr> <tr><td>EMK</td><td style="text-align: right;">_____</td></tr> <tr><td>SKD Ctrl</td><td style="text-align: right;">_____</td></tr> <tr><td>SKD CMK</td><td style="text-align: right;">_____</td></tr> <tr><td>Blockout</td><td style="text-align: right;">_____</td></tr> <tr><td>Main</td><td style="text-align: right;">_____</td></tr> <tr><td>HKP</td><td style="text-align: right;">_____</td></tr> <tr><td>MECH</td><td style="text-align: right;">_____</td></tr> <tr><td>ENG</td><td style="text-align: right;">_____</td></tr> <tr><td>JAN</td><td style="text-align: right;">_____</td></tr> <tr><td>OTHR</td><td style="text-align: right;">_____</td></tr> <tr><td>OTHR</td><td style="text-align: right;">_____</td></tr> </tbody> </table> | | Qty | q Per Cylinder | _____ | q Per Keyed alike Group | _____ | q Per Keyed different cyl. | _____ | | Qty | Control | _____ | CMK | _____ | CMK Ctrl | _____ | EMK | _____ | SKD Ctrl | _____ | SKD CMK | _____ | Blockout | _____ | Main | _____ | HKP | _____ | MECH | _____ | ENG | _____ | JAN | _____ | OTHR | _____ | OTHR | _____ |
| | Qty | | | | | | | | | | | | | | | | | | | | | | | | | | | | | | | | | | | | | | | | | | | | | | | | | | | | | | | | | |
| q G G G M | _____ | | | | | | | | | | | | | | | | | | | | | | | | | | | | | | | | | | | | | | | | | | | | | | | | | | | | | | | | | |
| q G G M | _____ | | | | | | | | | | | | | | | | | | | | | | | | | | | | | | | | | | | | | | | | | | | | | | | | | | | | | | | | | |
| q G G M | _____ | | | | | | | | | | | | | | | | | | | | | | | | | | | | | | | | | | | | | | | | | | | | | | | | | | | | | | | | | |
| q G M | _____ | | | | | | | | | | | | | | | | | | | | | | | | | | | | | | | | | | | | | | | | | | | | | | | | | | | | | | | | | |
| _____ | _____ | | | | | | | | | | | | | | | | | | | | | | | | | | | | | | | | | | | | | | | | | | | | | | | | | | | | | | | | | |
| _____ | _____ | | | | | | | | | | | | | | | | | | | | | | | | | | | | | | | | | | | | | | | | | | | | | | | | | | | | | | | | | |
| _____ | _____ | | | | | | | | | | | | | | | | | | | | | | | | | | | | | | | | | | | | | | | | | | | | | | | | | | | | | | | | | |
| _____ | _____ | | | | | | | | | | | | | | | | | | | | | | | | | | | | | | | | | | | | | | | | | | | | | | | | | | | | | | | | | |
| | Qty | | | | | | | | | | | | | | | | | | | | | | | | | | | | | | | | | | | | | | | | | | | | | | | | | | | | | | | | | |
| q Per Cylinder | _____ | | | | | | | | | | | | | | | | | | | | | | | | | | | | | | | | | | | | | | | | | | | | | | | | | | | | | | | | | |
| q Per Keyed alike Group | _____ | | | | | | | | | | | | | | | | | | | | | | | | | | | | | | | | | | | | | | | | | | | | | | | | | | | | | | | | | |
| q Per Keyed different cyl. | _____ | | | | | | | | | | | | | | | | | | | | | | | | | | | | | | | | | | | | | | | | | | | | | | | | | | | | | | | | | |
| | Qty | | | | | | | | | | | | | | | | | | | | | | | | | | | | | | | | | | | | | | | | | | | | | | | | | | | | | | | | | |
| Control | _____ | | | | | | | | | | | | | | | | | | | | | | | | | | | | | | | | | | | | | | | | | | | | | | | | | | | | | | | | | |
| CMK | _____ | | | | | | | | | | | | | | | | | | | | | | | | | | | | | | | | | | | | | | | | | | | | | | | | | | | | | | | | | |
| CMK Ctrl | _____ | | | | | | | | | | | | | | | | | | | | | | | | | | | | | | | | | | | | | | | | | | | | | | | | | | | | | | | | | |
| EMK | _____ | | | | | | | | | | | | | | | | | | | | | | | | | | | | | | | | | | | | | | | | | | | | | | | | | | | | | | | | | |
| SKD Ctrl | _____ | | | | | | | | | | | | | | | | | | | | | | | | | | | | | | | | | | | | | | | | | | | | | | | | | | | | | | | | | |
| SKD CMK | _____ | | | | | | | | | | | | | | | | | | | | | | | | | | | | | | | | | | | | | | | | | | | | | | | | | | | | | | | | | |
| Blockout | _____ | | | | | | | | | | | | | | | | | | | | | | | | | | | | | | | | | | | | | | | | | | | | | | | | | | | | | | | | | |
| Main | _____ | | | | | | | | | | | | | | | | | | | | | | | | | | | | | | | | | | | | | | | | | | | | | | | | | | | | | | | | | |
| HKP | _____ | | | | | | | | | | | | | | | | | | | | | | | | | | | | | | | | | | | | | | | | | | | | | | | | | | | | | | | | | |
| MECH | _____ | | | | | | | | | | | | | | | | | | | | | | | | | | | | | | | | | | | | | | | | | | | | | | | | | | | | | | | | | |
| ENG | _____ | | | | | | | | | | | | | | | | | | | | | | | | | | | | | | | | | | | | | | | | | | | | | | | | | | | | | | | | | |
| JAN | _____ | | | | | | | | | | | | | | | | | | | | | | | | | | | | | | | | | | | | | | | | | | | | | | | | | | | | | | | | | |
| OTHR | _____ | | | | | | | | | | | | | | | | | | | | | | | | | | | | | | | | | | | | | | | | | | | | | | | | | | | | | | | | | |
| OTHR | _____ | | | | | | | | | | | | | | | | | | | | | | | | | | | | | | | | | | | | | | | | | | | | | | | | | | | | | | | | | |
| <p>System Info:</p> <p>q NEW q Existing System</p> <p>PDQ SO # _____</p> <p>Your original PO# _____</p> <p>Original date of order _____</p> | <p>Cross Keying:</p> <table style="width: 100%;"> <thead> <tr> <th style="width: 60%;">Key Symbol</th> <th style="width: 40%;">Operated by (OB)</th> </tr> </thead> <tbody> <tr><td>_____</td><td>_____</td></tr> <tr><td>_____</td><td>_____</td></tr> <tr><td>_____</td><td>_____</td></tr> <tr><td>_____</td><td>_____</td></tr> <tr><td>_____</td><td>_____</td></tr> <tr><td>_____</td><td>_____</td></tr> </tbody> </table> | | Key Symbol | Operated by (OB) | _____ | _____ | _____ | _____ | _____ | _____ | _____ | _____ | _____ | _____ | _____ | _____ | | | | | | | | | | | | | | | | | | | | | | | | | | | | | | | | | | | | | | | | | | |
| Key Symbol | Operated by (OB) | | | | | | | | | | | | | | | | | | | | | | | | | | | | | | | | | | | | | | | | | | | | | | | | | | | | | | | | | |
| _____ | _____ | | | | | | | | | | | | | | | | | | | | | | | | | | | | | | | | | | | | | | | | | | | | | | | | | | | | | | | | | |
| _____ | _____ | | | | | | | | | | | | | | | | | | | | | | | | | | | | | | | | | | | | | | | | | | | | | | | | | | | | | | | | | |
| _____ | _____ | | | | | | | | | | | | | | | | | | | | | | | | | | | | | | | | | | | | | | | | | | | | | | | | | | | | | | | | | |
| _____ | _____ | | | | | | | | | | | | | | | | | | | | | | | | | | | | | | | | | | | | | | | | | | | | | | | | | | | | | | | | | |
| _____ | _____ | | | | | | | | | | | | | | | | | | | | | | | | | | | | | | | | | | | | | | | | | | | | | | | | | | | | | | | | | |
| _____ | _____ | | | | | | | | | | | | | | | | | | | | | | | | | | | | | | | | | | | | | | | | | | | | | | | | | | | | | | | | | |
| <p>System Level:</p> <p>q 1-SKD q 2-MK q 3-GM q 4-GGM</p> <p>q 4-GGGM q 4-GGGGM</p> | <p>Type:</p> <p>q High Security q IC q Standard q Other</p> | | | | | | | | | | | | | | | | | | | | | | | | | | | | | | | | | | | | | | | | | | | | | | | | | | | | | | | | | |
| <p>Keys:</p> <p>q Standard SCC</p> <p>q Restricted*</p> <p>q Specific Keyway: _____</p> <p><i>*Restricted Keyway requires system approval</i></p> <p>q 5 Pin q 6 Pin q 7 Pin</p> <p>Key Control:</p> <p>q Visual Key Control Keys Only</p> <p>q Visual Key Control Keys and Cylinders</p> <p>q Visual Key Control Cylinders Only</p> <p>q Concealed Key Control Keys and Cylinders</p> <p>q Concealed I Key Control Cylinders Only</p> <p>q DND</p> <p>q US Property DO NOT DUPLICATE</p> <p>q Special Marking: _____</p> <p>_____</p> | <p>Additional Information:</p> <p><i>(Including system expansion and Special Remarks)</i></p> <p>_____</p> <p>_____</p> <p>_____</p> <p>_____</p> <p>_____</p> <p>Name of individual in organization who is knowledgeable about this project should clarification be required.</p> <p>Name: _____</p> <p>Phone: _____</p> <p>Email: _____</p> <p style="text-align: center;">2230 Embassy Drive, Lancaster, PA 17603 • 1-800-441-9692</p> | | | | | | | | | | | | | | | | | | | | | | | | | | | | | | | | | | | | | | | | | | | | | | | | | | | | | | | | | |

This sheet to be used with Keying Schedule Form

Form Available Online: <https://www.pdqlocks.com/product/master-key-systems/>





Keying System Worksheet



Job Reference _____
 Information _____
 Date _____ By _____
 Approved By _____
 Date _____

| |
|------------------|
| Grand Master Key |
| Area/Dept |

Instructions: Indicate the highest level master key symbol in the top line of each box. Identify the area or department, indicate the total number of key changes, including future expansion. Do not use letters I, O, or Q in key symbols.

Page of

Selective _____ Control Key Used with IC cores only
 Master Key _____ CMK Construction Master Keying

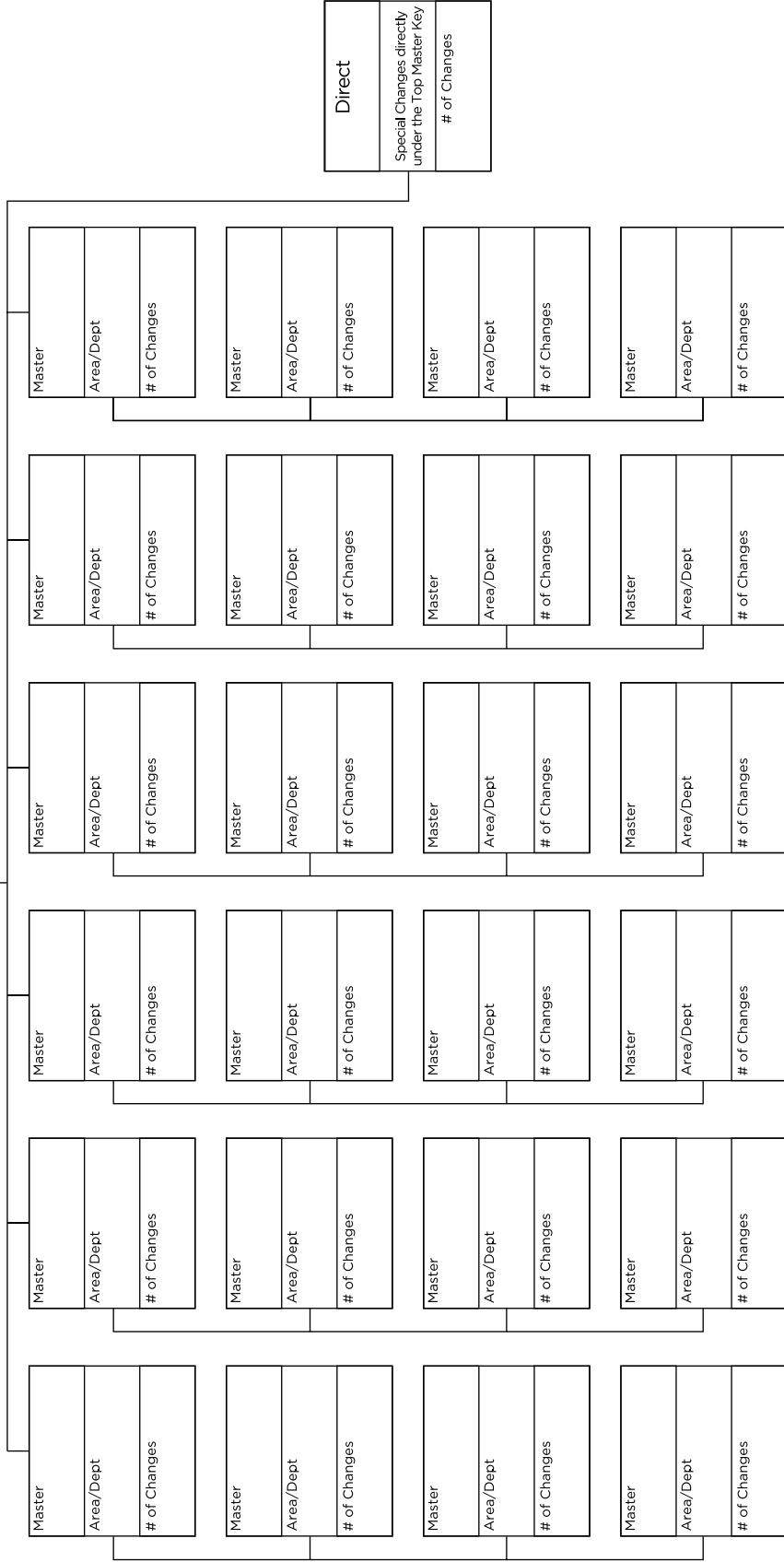

Single Keyed Changes

| |
|---------------|
| SKD |
| Door# or Area |

| |
|---------------|
| SKD |
| Door# or Area |

| |
|---------------|
| SKD |
| Door# or Area |

Special Instructions

Change key only, will not be operated by any other key within the system

Keying Schedule Form

| | | |
|-----------------------|---------------------------|-----------------------|
| Customer Name: | Purchase Order No. | Page of |
|-----------------------|---------------------------|-----------------------|

| | | | |
|------------------|------------------------------|----------------|-----------------|
| Quantity: | Series/Function/Trim: | Finish: | Options: |
|------------------|------------------------------|----------------|-----------------|

Special Stamping:

| <i>Item</i> | <i>Quantity</i> | <i>Key Symbol</i> | <i>Hand (Specify Qty)</i> | | | | <i>Door Number (Up to 10 Characters)</i> | <i>Heading (Up to 10 Characters)</i> |
|-------------|-----------------|-------------------|---------------------------|-----------|------------|------------|--|--|
| | | | <i>RH</i> | <i>LH</i> | <i>RHR</i> | <i>LHR</i> | | |
| | | | | | | | | |
| | | | | | | | | |
| | | | | | | | | |
| | | | | | | | | |
| | | | | | | | | |
| | | | | | | | | |
| | | | | | | | | |
| | | | | | | | | |
| | | | | | | | | |
| | | | | | | | | |
| | | | | | | | | |
| | | | | | | | | |
| | | | | | | | | |
| | | | | | | | | |
| | | | | | | | | |
| | | | | | | | | |
| | | | | | | | | |
| | | | | | | | | |
| | | | | | | | | |
| | | | | | | | | |
| | | | | | | | | |
| | | | | | | | | |
| | | | | | | | | |
| | | | | | | | | |

2230 Embassy Drive, Lancaster, PA 17603 • 1.800.441.9692

To be used with PDQ Master Keying Layout form

Form Available Online: <https://www.pdqlocks.com/product/master-key-systems/>



Finishes

PDQ Manufacturing finishes are durable, top-quality finishes obtained by the processing of solid brass, bronze, stainless steel and other materials. It is important that usage, climate and other conditions be taken into consideration when selecting finishes. This is especially true in areas subjected to corrosive vapors, humid climate or sea air, which in short time may have a damaging effect on finishes. To preserve appearance, cleaning and care may be required. Non-clear coated finishes should not be cleaned with soap or solvents; organically coated surfaces should be cleaned periodically with mild, non-abrasive soap and buffed lightly with a clean cloth. Contact PDQ technical service for recommendations on the care of finished hardware.

BHMA symbols and U.S. Code Designations (noted below in parentheses) are used in some cases to indicate the similarity of finish appearance, regardless of the base material.

PDQ strives to stock all finishes shown in this price book for immediate shipment (1-2 days, less keying). However, we suggest you contact the factory to confirm availability for large jobs.

Refer to Each Lock Series Section for Standard Finish Availability.

Architectural



605 (US3)
Bright Brass



606 (US4)
Satin Brass



612 (US10)
Satin Bronze



613E
Dark Oxidized Satin
Bronze



619 (US15)
Satin Nickel

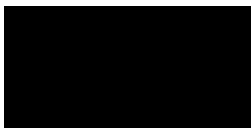

622 (US19)
Flat Black



625 (US26)
Bright Chromium



626 (US26D)
Satin Chromium



629 (US32)
Bright Stainless Steel



630 (US32D)
Satin Stainless Steel



652 (US26D)
Satin Chromium

Painted



689 (US28)
Aluminum



693
Black



695
Dark Duranodic
Bronze



696 (US4)
Satin Brass (Gold)

Finishes shown are representative only. PDQ cannot guarantee that product shipped will match finishes shown.
Not all products are available in all finishes listed.

Lock Handing

What is Lock Handing?

The handing of a lock is important in order to ensure that the correct side of the door is secure, the levers are oriented properly, and that the door closes properly.

There are 2 parts to a door and lock handing, the handing (left or right) and the swing of the door (whether it is reversed or standard). There are 4 different lock handings; left hand (LH), right hand (RH), left-hand reverse (LHR), and right-hand reverse (RHR).

There are many ways to determine handing however PDQ recommends the following method:

- Stand on the outside (secure side) of the door
- Note the location of the hinges, not the lock
- If the hinges are on the left, it's a left-hand door
- If the hinges are on the right, it's a right-hand door
- Next note if the door swings toward you or away from you
- If the door swings away from you, it's a standard swing door
- If the door swings towards you, it's a reverse bevel door

See the illustration below for examples of how to determine the door handing you need when placing your PDQ order.

How to Determine Hand of Door

In Swing Door

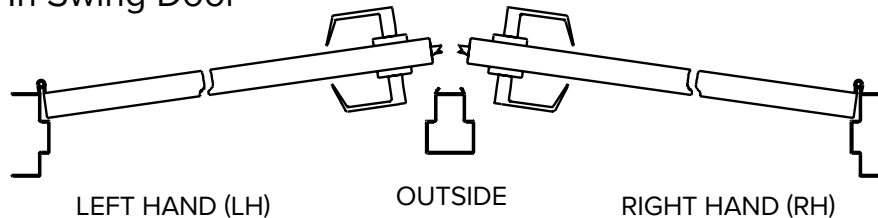

Out Swing Door

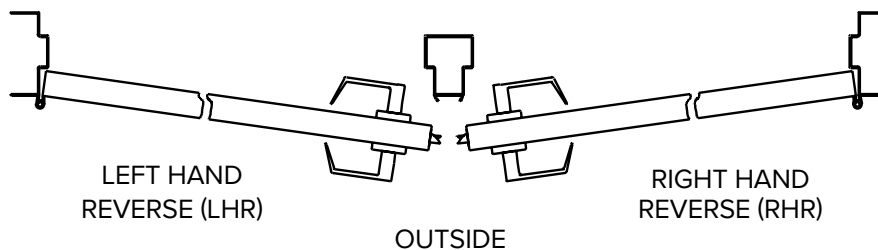

Weight Chart

| Locksets* | | | |
|---------------------------|---------------------------|----------------------|-------------------------------------|
| <i>Item</i> | <i>Function</i> | <i>Case Quantity</i> | <i>Average Weight/Case (lbs.)**</i> |
| <i>MR (Rose)</i> | <i>Entrance</i> | <i>6</i> | <i>45</i> |
| <i>MR (Escutcheon)</i> | <i>Entrance</i> | <i>6</i> | <i>46</i> |
| <i>XGT</i> | <i>Entrance</i> | <i>6</i> | <i>33</i> |
| <i>GT</i> | <i>Entrance</i> | <i>6</i> | <i>33</i> |
| <i>GP</i> | <i>Entrance</i> | <i>6</i> | <i>30</i> |
| <i>SD</i> | <i>Entrance</i> | <i>10</i> | <i>37</i> |
| <i>SX Ball</i> | <i>Entrance</i> | <i>10</i> | <i>32</i> |
| <i>SV Ball</i> | <i>Entrance</i> | <i>20</i> | <i>43</i> |
| <i>CL</i> | <i>Entrance</i> | <i>6</i> | <i>31</i> |
| Deadbolts | | | |
| <i>Item</i> | <i>Function</i> | <i>Case Quantity</i> | <i>Average Weight/Case (lbs.)**</i> |
| <i>KT Single Cylinder</i> | <i>116</i> | <i>10</i> | <i>19</i> |
| <i>KT Double Cylinder</i> | <i>137</i> | <i>10</i> | <i>22</i> |
| <i>KM Single Cylinder</i> | <i>116</i> | <i>20</i> | <i>41</i> |
| <i>KM Double Cylinder</i> | <i>137</i> | <i>20</i> | <i>54</i> |
| <i>KV Single Cylinder</i> | <i>116</i> | <i>20</i> | <i>26</i> |
| <i>KV Double Cylinder</i> | <i>137</i> | <i>20</i> | <i>35</i> |
| Closers | | | |
| <i>Item</i> | <i>Application</i> | <i>Case Quantity</i> | <i>Average Weight/Case (lbs.)**</i> |
| <i>3100</i> | <i>Tri-Pack</i> | <i>10</i> | <i>61</i> |
| <i>5100</i> | <i>Tri-Pack</i> | <i>6</i> | <i>48</i> |
| <i>5300</i> | <i>Tri-Pack</i> | <i>6</i> | <i>41</i> |
| <i>5500</i> | <i>Tri-Pack</i> | <i>6</i> | <i>41</i> |
| <i>7100</i> | <i>Tri-Pack</i> | <i>4</i> | <i>50</i> |
| Exit Devices | | | |
| <i>Item</i> | <i>Application</i> | <i>Case Quantity</i> | <i>Average Weight/Case (lbs.)**</i> |
| <i>4200R 3'</i> | <i>Rim</i> | <i>4</i> | <i>43</i> |
| <i>4200V 3'</i> | <i>Surface Vertical</i> | <i>4</i> | <i>61</i> |
| <i>4200RA 4'</i> | <i>Rim</i> | <i>4</i> | <i>45</i> |
| <i>4200VA 4'</i> | <i>Surface Vertical</i> | <i>4</i> | <i>67</i> |
| <i>6300R 3'/6320R 2'</i> | <i>Rim</i> | <i>4</i> | <i>60</i> |
| <i>6310R 4'</i> | <i>Rim</i> | <i>4</i> | <i>68</i> |
| <i>6300V 3'/6320V 2'</i> | <i>Surface Vertical</i> | <i>4</i> | <i>70</i> |
| <i>6310V 4'</i> | <i>Surface Vertical</i> | <i>4</i> | <i>78</i> |
| <i>6300C 3'/6320C 2'</i> | <i>Concealed Vertical</i> | <i>4</i> | <i>68</i> |
| <i>6310C 4'</i> | <i>Concealed Vertical</i> | <i>4</i> | <i>72</i> |
| <i>6300M 3'/6320M 2'</i> | <i>Mortise</i> | <i>4</i> | <i>68</i> |
| <i>6310M 4'</i> | <i>Mortise</i> | <i>4</i> | <i>72</i> |
| <i>6300D 3'</i> | <i>Dummy</i> | <i>4</i> | <i>44</i> |
| <i>6310D 4'</i> | <i>Dummy</i> | <i>4</i> | <i>46</i> |
| <i>6320D 2'</i> | <i>Dummy</i> | <i>4</i> | <i>42</i> |
| <i>6400R 3'/6420R 2'</i> | <i>Rim</i> | <i>4</i> | <i>58</i> |
| <i>6410R 4'</i> | <i>Rim</i> | <i>4</i> | <i>68</i> |
| <i>6400V 3'/6420V 2'</i> | <i>Surface Vertical</i> | <i>4</i> | <i>70</i> |
| <i>6410V 4'</i> | <i>Surface Vertical</i> | <i>4</i> | <i>74</i> |
| <i>6400C 3'/6420C 2'</i> | <i>Concealed Vertical</i> | <i>4</i> | <i>68</i> |
| <i>6410C 4'</i> | <i>Concealed Vertical</i> | <i>4</i> | <i>72</i> |

*Data is with PHL lever unless otherwise noted. **Add approximately 2 lbs. for fire rated device.

SECURING CONFIDENCE **OPENING** **POSSIBILITIES**



Phone: 717.656.4281
Tech Support: 833.273.7832



Headquarters:
2230 Embassy Drive,
Lancaster, PA 17603

P.O. Box 6426
Lancaster, PA 17607



Email: help@pdqlocks.com



Regional Distribution Centers:
Lancaster, PA | Norcross, GA |
Auburn, WA