

Price Book

Effective March 1, 2024 – Revised 4/17/24

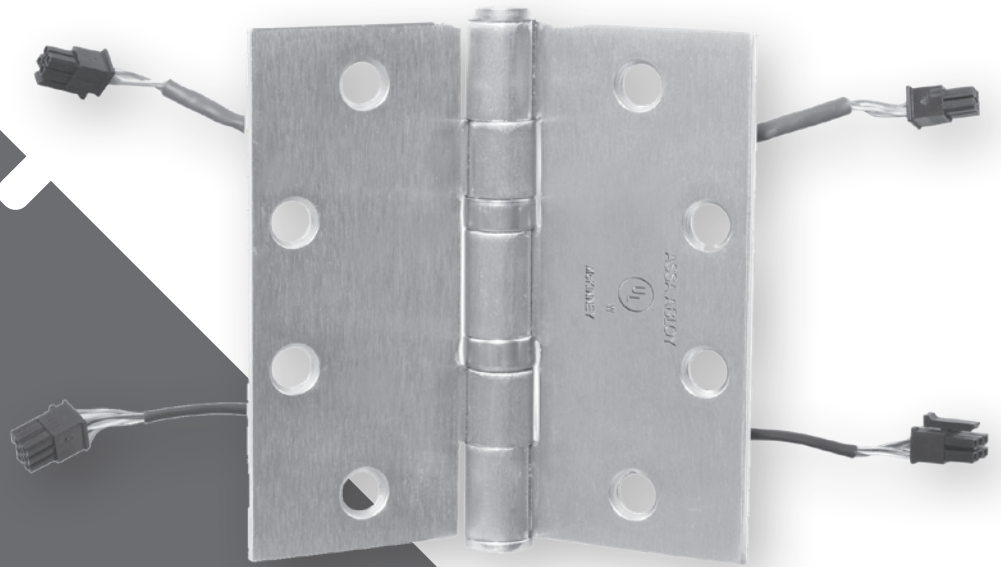

McKinney[®]
ASSA ABLOY

Experience a safer
and more open world

Table of Contents

General Information.....	GEN-1 – GEN-8
Finishes.....	GEN-3 – GEN-4
Options.....	GEN-5 – GEN-6
Index.....	GEN-7
Buying Program Codes.....	GEN-8
Full Mortise Hinges.....	FM-1 – FM-14
MacPro® Hinges.....	FM-13, FM-14
Electric Hinges.....	EH-1 – EH-14
MacPro® Electric Hinges.....	EH-7
Full Mortise Anchor Hinge Sets.....	AH-1 – AH-2
Reinforcing Pivots.....	AH-2
Half Mortise Hinges.....	HM-1
Half Surface Hinges and Back Plates.....	HS-1
Full Surface Hinges.....	FS-1
Spring Hinges.....	SH-1
MacPro® Spring Hinges.....	SH-1
Rescue Hardware.....	RH-1
Specialty Hinges & Residential.....	SP-1 – SP-2
Interim Hinges.....	SP-1
Cam Lift Hinges.....	SP-1
Designer Hardware - Deco Tips.....	DH-1 – DH-2
Concealed Hinge.....	DH-1
Square Barrel Hinges.....	DH-2
Screw Packs.....	SPK-1

McKinney Product Notes

The following products have been discontinued:

US9 Bright Bronze Finish has been discontinued 11.1.2021 Except where shown in the current price book.

D4 Black Powder Coat Finishes will be phased out and replaced by Black Suede Powder Coat - BSP.



Experience a safer
and more open world

800 346 7707 | www.mckinneyhinge.com
USA Prices Effective March 1, 2024

Copyright © 2024, ASSA ABLOY Accessories and Door Controls Group, Inc. All rights reserved. Reproduction in whole or in part without the express written permission of ASSA ABLOY Accessories and Door Controls Group, Inc. is prohibited.

ACCEPTANCE

We reserve the right to decline an order, in whole or in part, when the type or quantity of goods or credit worthiness of the Purchaser is not satisfactory to us in our sole and absolute discretion.

Purchase Orders, Competitive Price Quotation ("CPQ") requests, Acknowledgements or the like issued by the Purchaser that have contrary standard terms and conditions are not binding unless such terms and conditions are approved in a separate written agreement by authorized representatives. In the event of an acceptance of Purchaser's Purchase Order the Purchaser agrees that such acceptance is solely conditioned on Purchaser's acceptance of the terms and conditions set forth in this instrument, regardless of the terms and conditions specified in Purchaser's Purchase Order. The terms and conditions in Purchaser's Purchase Order which conflict with the terms and conditions of this instrument shall be disregarded and are hereby rejected, and this instrument shall constitute the entire agreement between McKinney and the Purchaser.

In the event that McKinney does not enforce or require strict performance of any term or condition hereof, or any other document, instrument or other agreement relating to goods sold, such lack of enforcement or requirement of strict performance will not waive, affect or diminish any right to enforce or require strict performance of such term or condition in the future.

PRICES

All prices are subject to change without notice and are not guaranteed. All shipments will be made at prices in effect at the time of shipment.

Possession of this price list does not constitute an agreement to sell.

We reserve the right to correct clerical, stenographic and other obvious errors at any time.

TAXES

If under any law now or hereafter passed the seller is required to pay a tax on sales, or on an excise tax, the amount of these taxes will be added to the invoice value.

QUOTATIONS

Complete shipment of the order must fall within quoted dating. Expired quotes will not be honored without prior authorization. Contact your Door Security Solutions representative for additional information.

The quote number must be referenced on the purchase order to receive quoted pricing.

DELIVERY

Seller shall not be liable for any delay in delivery, or failure to deliver, due to any cause beyond the Seller's control, including but not limited to fires, floods, strikes, or other labor disputes, accidents to machinery, acts of sabotage, riots, precedence or priorities granted at the request or for the benefit, directly or indirectly, of the federal or any provincial government or any subdivision or agency thereof, delay in transportation or lack of transportation facilities, restrictions imposed by the federal, provincial or other governmental legislation or rules or regulations thereof.

CREDIT

Acceptance of orders and deliveries thereof shall at all times be subject to our approval of credit.

PAYMENT TERMS

Orders based on quotations for specific jobs will be invoiced at prices in effect on the date such orders are accepted. Other orders will be invoiced at prices in effect on the date of shipment.

Errors and omissions are subject to correction on acknowledgement which in all circumstances supercedes all pricing shown herein.

Terms are 1% 15 Net 30.

Visa, MasterCard, DISCOVER, and American Express are accepted for established open accounts only. Credit Card terms are NET, no discounts allowed.

A charge of \$50.00 will be made for itemization. A charge of \$25.00 will be made when changes are requested on itemized jobs already processed.

Surcharge of \$15 NET will be added to all orders under \$100 NET.

On non-standard items a 5% over or under run constitutes a complete order.

TERMS ARE 1% 15 NET 30.

It is understood that a finance charge may be imposed which is the lesser or one and one-half percent (1 ½) per month of the highest rate allowed by law on any amount which becomes past due and delinquent. Additionally the Customer shall be responsible for all collection costs, court costs and reasonable attorney's fees (where allowed by law) in connection with the recovery of any delinquent amount.

NOTE: PRICES PER EACH NET PRODUCT WEIGHT INFORMATION

Weights indicated throughout this price list are approximate for brass, bronze or stainless steel base material. Aluminum base materials weigh approximately ½ the listed weights.

WARRANTY

McKinney products are not designed for or intended for aftermarket modification. The warranty on McKinney products becomes void if the product is modified in any way, regardless of whether the modification causes or contributes to any alleged defect. Warranty voiding modifications include, but are not limited to, third-party electrification of non-electric products and/or the installation of non-approved or non-McKinney components.

If a McKinney product is modified it no longer meets industry certification and

Continued...

quality control standards applicable to the original product and is no longer a genuine McKinney product. A modified product may not be sold as a McKinney product and no McKinney trademarks or certification marks based on the original McKinney product, such as (but not limited to) U.L. or ANSI/BHMA marks, may appear anywhere on the modified product or on any packaging, literature or instructions sold with the modified product.

All original McKinney packaging and literature carries McKinney trademarks and must be destroyed if the original McKinney product is modified. Portions of the product that carry a McKinney trademark or certification mark must be discarded and/or replaced by the party making the modification. U.L. and other certification testing and markings are also the responsibility of the party making the modification. The use of McKinney trademarks on modified products constitutes trademark infringement.

SHIPMENTS

Once in the hands of the Transportation Company, the Purchaser assumes the risk of loss or damage in transit.

NET orders of \$2000 or more, freight will be shipped prepaid in the Continental United States the most economical way. For prepaid freight to AK and HI, \$2750 NET. Seller determines carrier and shipment method. Minimum freight is \$140.

All orders are F.O.B shipping point via the most economical routing. Purchaser assumes the risk of loss or damage in transit.

The acknowledged ship date is based upon inventory availability. We will notify you if there is a longer lead time or a back order. We will not be responsible for paying expedited shipping expenses relating to delays or buyer back charges associated with these delays.

Shipments by Air, Parcel Post, Bus or Express are F.O.B. factory with no freight allowance.

If You have chosen to participate in our WOG program, a signed agreement must be on file. Orders will be held for a maximum of thirty (30) days. After such time, if pre-paid freight minimums have not been met, orders will be shipped the most economical way at the customer's cost. All orders for WOG customers will be held with other goods unless specified on each Purchase Order.

CANCELLATIONS

Cancellation of special order material, non-stock items or special sizes that have not shipped are subject to cancellation charges based on factory cost accrued prior to cancellation request.

RETURNED GOODS

No returns will be allowed without previous authorization by the factory. Returned goods are only allowed on stock items shipped within 90 days of request. Special order material and customized product may not be returned.

Authorized returns must be in resale condition. Returns will be subject to a minimum 25% restocking fee plus freight.

CLAIMS

Claims for shortages must be received within 30 days of invoice. Inspect before you sign. If there is a shortage or damage, **accept shipment only after freight agent makes a damage or shortage notation on your freight bill, bill of lading, or delivery receipt.** If damage or loss is evident, notify your freight agent and request inspection within 10 days of receipt of goods. Shipments are packed in approved containers. Claims must be made within 30 days of shipment and are subject to approval. Claims made after 30 days will not be honored. Our responsibility for damage, visible or concealed, ceases upon delivery to the transportation company.

ORDERS

Orders may be emailed to orders.mckinney@assaabloy.com or faxed to 877-888-2772

Quick Ship Items are indicated by check mark (✓).

NON-CATALOGED PRODUCTS

Products not cataloged or listed in this price book will be considered as special products, and will not be manufactured without prior written approval from McKinney. A minimum special handling charge of \$150 will be added for non-cataloged product. Any additional labor or material required will be charged accordingly. Special products require special handling, and therefore standard lead times may not apply. Please consult with your Sales Representative for further details.

McKinney
ASSA ABLOY

Experience a safer
and more open world

GEN-2

800 346 7707 | www.mckinneyhinge.com
USA Prices Effective March 1, 2024

Copyright © 2024, ASSA ABLOY Accessories and Door Controls Group, Inc. All rights reserved. Reproduction in whole or in part without the express written permission of ASSA ABLOY Accessories and Door Controls Group, Inc. is prohibited.

McKinney and B.H.M.A. Finish Symbols

BHMA Code

Base Material Ferrous (Steel)	Non-Ferrous (Brass or Stainless)	McKinney FINISH
600		P
632	605	3
633	606	4
638	609	5
636	610	7
637	611	9
639	612	10
641	614	10A
640	613	10B
643	616	11
645	618	14
646	619	15
649	623	20
650	624	20A
651	625	26
652	626	26D
	629	32
	630	32D

McKinney and Government Finish Symbols

U.S. Finish	Description	McKinney	Price
U.S.P.	Prime Powder Coat for Painting	P	Listed
U.S. 3	Bright Brass	3	Listed
U.S. 4	Dull Brass	4	Listed
U.S. 5	Dull Brass, Oxidized	5*	30% over 10B
U.S. 7	Brass, Nickel Oxidized, Bright Relieved	7*	30% over 10B
U.S. 9	Bright Bronze	9**	Listed
U.S. 10	Dull Bronze	10	Listed
U.S. 10A	Antique Bronze, Oiled and Lacquered	10A*	Same as 26
U.S. 10B	Antique Bronze, Oiled	10B	Listed
U.S. 11	Dull Bronze, Oxidized	11*	30% over 10B
U.S. 14	Bright Nickel Plated	14	Same as 26
U.S. 15	Dull Nickel Plated	15	Same as 26D
U.S. 20	Statuary Bronze, Light	20*	30% over 10B
U.S. 20A	Statuary Bronze, Dark	20A*	30% over 10B
U.S. 26	Bright Chromium	26	Listed
U.S. 26D	Dull Chromium	26D	Listed
U.S. 32	Polished Stainless Steel	32	Listed
U.S. 32D	Dull Stainless Steel	32D	Listed

* Check with the factory for availability and pricing on these finishes.

** 9 Finish is only available on those items listed in the price book with part #'s.

McKinney Powder Coat Finishes – Used to configure pricing when the product is not found in the price book with the required finish. – *May not be available on MacPro® or Double Acting Spring Hinges or Rescue Hardware*

	Finish	Steel Base	Finish on Stainless Base	Stainless Base
Dark Bronze Powder Coat D3	D3	Add \$8.00 to 26D	N/A	
Dark Oxidized Satin Bronze 10BE	10BE	\$7.00 Less than 10B	10BE (SS)	\$8.00 add to 32D
Black Suede Powder Coat BSP	BSP	15% Less than 10B	BSP (SS)	\$15.00 add to 32D
White Suede Powder Coat WSP	WSP	15% Less than 10B	WSP (SS)	\$15.00 add to 32D
Clear Powder over Stainless	CPC	N/A	CPC (SS)	\$15.00 add to 32D
MicroShield® Agion Antimicrobial 32DBIO	32DBIO	N/A	32DBIO (SS)	\$15.00 add to 32D
10B over Stainless		N/A	32D x 10B	\$15.00 add to 32D
Extra Dark Bronze Equivalent (Custom Finish) 314E	314E*	30% over 10B	32D x 314E	\$25.00 add to 32D

Every effort is made to furnish finishes which do comply with the Standard, however we cannot guarantee that our finish will match other manufacturers finish. Where a special finish or a matched finish is required, a sample must be submitted with the order.

* P.O.A. – Price on Application – Consult the factory for pricing and availability on these custom finishes.

722 30% over 10B for clear coats

McKinney
ASSA ABLOY

Experience a safer
and more open world

800 346 7707 | www.mckinneyhinge.com
USA Prices Effective March 1, 2024

Options/Additions Where Not Listed

No Logo	
Hinges supplied less ASSA ABLOY logo (not available on LISTED Hinges) – New lead times will apply and factory may need to adjust lead times after lead times of order is originally acknowledged.	Add 30% to price
Blank Hinges (No Screw Holes)	
Blank hinges regularly furnished without swaging (flat back) unless otherwise specified.	Add 30% to price
Bulk Package, Suffix BP	
Consult factory for availability	No additional charge
Special Swaging	
Special Swaging	Add 30% to price

Add \$18.00 to electrical option add for all Swing Clear Hinges.

See page EH-7 for MacPro Electric Hinges, the below options are not applicable to MacPro.

CC Option- Concealed Circuit		
Brass, Steel or Stainless Steel Base		Add
4 wires - suffix CC4		\$151.50
8 wires - suffix CC8		\$246.50
12 wires - suffix CC12		\$320.00
Extra Long Leads (over 12") for CC4, CC8		\$10.00 per foot
Extra Long Leads (over 12") for CC12		\$15.00 per foot
CC Option- Concealed Circuit with 2 18-Gauge Wires		
Brass, Steel or Stainless Steel Base	Add	4' Lead Add
2 wires - suffix CC2-18	\$220.00	\$22.00
4 wires - suffix CC4-18	\$231.00	\$33.00
6 wires - suffix CC6-18	\$242.00	\$44.00
8 wires - suffix CC8-18	\$264.00	\$55.00
10 wires - suffix CC10-18	\$286.00	\$66.00
* Hinges are provided with two 18-gauge wires, additional wires are standard 28-gauge		
MG-16 Mortar Guard (Part #63333)		\$25.00 each
QC Option- Electrolynx® Quick Connect Concealed Circuit		
Brass, Steel or Stainless Steel Base		Add
4 wires - suffix QC4		\$166.50
8 wires - suffix QC8		\$262.50
12 wires - suffix QC12		\$348.50
Extra 6" Pigtail for QC Butt Hinge		Add
09716 QC4 Pigtail		\$10.00
09715 QC8 Pigtail		\$12.00

Options/Additions Where Not Listed

PoE Option - Power over Ethernet	
Available on 4½" and 5" height hinges only	Add
Brass or Steel Base	\$690.50
MM Option - Magnetic Monitoring	
Magnetic Monitoring - suffix MM	\$340.50
MM Magnet Assembly & Switch, MK36026	\$150.00
Non Removable Door Suffix NRD	
2 Knuckle One NRD provided per set of 3 hinges	Add \$10.00 per door
Non Removable Pins	
Set screw in barrel suffix (NRP SET SCS ONLY \$.50 EA NO DISC)	TA714, T2714, TA2714 Add \$3.00 All others Add \$5.00
Raised Barrel Full Mortise Hinges Bearing Hinges Only	
Raised barrel prefix RB for Standard Weight and RH for Heavy Weight 4½" x 4½" Standard and Heavy Weight. 5" x 4½" Heavy Weight Only. 5 Knuckle Only. Hinges are NRP and reversible for handing.	Standard Weight Add \$34.50 Heavy Weight Add \$47.00
Round Corner Prefix RC	
5/32", 1/4" or 5/8" Round corner full mortise only.	Add \$5.00 each
Round corner hinges (RC) will be furnished in 1/4" radius unless otherwise specified.	
Beveled Hinges (where doors are beveled on hinge side specify as follows)	
For 3 knuckle hinges use 5000 series. Example TA792 will become TA5792 For 5 knuckle hinges use a 4000 series. Example TA2714 or T4A3386 will become a TA4714 or T4A4386 TA2731 will become A TA4731, A TA3350 becomes a TA5350, TA3750 becomes TA5750	If a part # is not shown in price book for Beveled Edge Hinge, add \$24.00 to the price of Square Edge Hinge
Safety Stud Featured Suffix SSF	Add \$15.00 each
Slip in Hinges Suffix SIH Type I (Handed)	Add \$35.00 each
SIH Type II Regular weight bearing hinge only (Indicate if not ordering NRP option)	
Special Screws (½" x 12-24 machine" – 1¼" x 12 wood) Consult factory for price and minimum requirements on additional sizes.	
TORX Pin head security screws – Suffix TXS, machine screws provided. Wood screws by request only.	
Stainless Torx	\$3.00 each net add per hinge
TORX BIT*	\$34.00 each
TORX bit holder tool*	\$48.00 each
*#20 - 1/2" x 12-24 & 1-1/4" x 12 wood screw *#20 - 1/2" x 1/4"-20 machine screw, 1-1/2" x 12 wood screw	
TIPS	
Regular or heavy weight plain bearing, oil impregnated or ball, Hospital Tips – Prefix H, (includes NRP)	Add \$16.00 each
Solid Brass Ball Tips (suffix x BT) or Steeple Tips (suffix x ST) up to 6" in height*	Add \$11.00 each
Deco Tips for two, three and five knuckle hinges, where not listed, suffix RT, FT, GT, LT, KT	Add \$11.00 each
5 KNUCKLE BEARINGS	
TB for 5 Knuckle Bearings Standard Weight	Add \$10.00 each
T4B for 5 Knuckle Bearings Heavy Weight	Add \$60.00 each
Architectural Hardware Finish Presentation Folder FS86 73002	



Index

451	SH-1	RCTA2314	SP2	T4A3786	FM-12
452	SH-1	SP3786	SP-1	T4A3795	FM-13
453	SH-1	SP3386	SP-1	T4A3796	HS-1
5540	AH-2	SQ3331	DH-2	T4A3789	HM-1
5545	AH-2	T2314	FM-4	T4A4795	FM-13
8540	AH-2	T2714	FM-5	T4B3386	FM-10
8545	AH-2	T2895	SP-2	T6B3786	FM-13
1400	SP-2	TA314	FM-1	T6B3386	FM-10
1414	SP-2	TA386	FM-1		
1458	SP-2	TA392	AH-1		
1502	SH-1	TA393	AH-1		
BP-10	HS-1	TA394	AH-1		
BP-11	HS-1	TA714	FM-2		
CSS-9	RH-1	TA786	FM-3		
DLS-8	RH-1	TA792	AH-2		
DS-6	RH-1	TA794	AH-2		
Deco Hinges	DH-1 – DH-2	TA795	FM-3		
Hinge Pin Stops	FM-6, FM-13	TA2314	FM-4		
EP-5J	RH-1	TA2372	HS-1		
HTA386	FM-2	TA2395	FM-5		
HTA714	FM-3	TA2398	FM-5		
HTA786	FM-3	TA2714	FM-6 – FM-7		
HTA2714	FM-8	TA2731	FM-8		
MG-16	GEN-5	TA2771	FS-1		
MK40A: (MK4001A – Replaces MK40A)	DH1	TA2772	HS-1		
MK80	DH1	TA2774	HM-1		
MK80	DH1	TA2798	FM-8		
MK80A	DH1	TA2895	FM-9		
MK80A	DH1	TA3331	FM-9		
MK80SS	DH1	TA3350	FM-9		
MK100	DH1	TA3374	HM-1		
MK150	DH1	TA3383	DH-2		
MK200	DH1	TA3750	FM-11		
MKCL134LH	SP1	TA4895	FM-9		
MKCL134RH	SP1	TA5792	AH-2		
MKCL180LH	SP1	TA2314BT	FM-5		
MKCL180RH	SP1	TA2314ST	FM-5		
MKCL250LH	SP1	TCA2314	FM-5		
MKCL250RH	SP1	TCA2714	FM-7		
MKCL2500LH	SP1	TCA3386	FM-10		
MKCL2500RH	SP1	TCA3786	FM-12		
MP79	FM-13	T4A3381	FS-1		
MPS60	SH-1	T4A3382	HS-1		
MPB68	FM-14	T4A3384	HM-1		
MPB91	FM-14	T4A3386	FM-10 – FM-11		
MPB99	FM-14	T4A3395	FM-11		
MPS679	SH-1	T4A3781	FS-1		
PH-4	SP-1	T4A3782	HS-1		
		T4A3784	HM-1		

McKinney

ASSA ABLOY

Experience a safer
and more open world

GEN-7

McKinney Buy Program Codes

Type	Code	Description
5 Knuckle Hinges	50	For all hinges 4½" and greater in height
5 Knuckle Hinges	50F	For all hinges 4" height
5 Knuckle Hinges	50E	For all hinges 3½" height
T2314, TA2314, TCA2314, T2714, TA2714, TCA2714, TA2798, TA2895, T4A3386, TCA3386, T4A3395, T4A3786, TCA3786, T4A3795, T4A4795, TA4895, TA2774, TA3374, T4A3384, T4A3784, TA2372, T4A3782, T4A3796, TA2772, T4A3382, BP10, BP11, TA2771, T4A3381, T4A3781, SP3386, SP3786		
MacPro Hinges	57	
MP79, MPB79, MP91, MPB91, MPB68, MPB99, MPS60, MPS679		
3 Knuckle Hinges	30	For all hinges 4½" and greater height
3 Knuckle Hinges	30F	For all hinges 4" height
3 Knuckle Hinges	30E	For all hinges 3½" height
TA314, TA386, TA714, TA786, TA795, TA391, TA392, TA393, TA394, TA5394, TA791, TA792, TA794, TA5792		
Electric Hinges		
5 Knuckle	59	Do not add NRP as these hinges have a knurled hollow pin and are 'nonremovable' by design.
3 Knuckle	39	
2 Knuckle	29	
Do not add NRP as these hinges come NRP as a standard. All Swing Clear (hinges ending in 89, 95, 96, for instance TA2895, T4A3796) Anchor Hinge Sets (for instance TA391, TA5392, TA792 etc) ½ Mortise Hinges ending in 74 or 84 (for example TA2374 or T4A3384) ½ Surface Hinges ending in 72 or 82 (for example TA2372 or T4A3382), Raised Barrel Hinges, Hospital Tip Hinges		
Wire Harness Products	79	
QC-C300 thru QC-C1500, QC-C300P thru QC-C1500P, QCR001, QC-R002, QC-R003, QC-RF2, QC-RF4, QCR-F8, QC-RM2, QC-RM4, QC-RM8, QC-FT2024, QC-FT2630, QC-MT2024, QC-MT2630, QC-DCC, TSBC-CXL, TSB-C, EPT, EPTL, EL-EPT, EL-EPTL, Po-EC206P thru PoE-C1500P		
2 Knuckle Hinges	20	For all hinges 4½" and greater height
2 Knuckle Hinges	20F	For all hinges 4" height
TA2731, TA3331, TA3350, TA3750, SQ3331, TA3383, MK4001A, MK80, MK100, MK150, MK200, MCKCL134, MCKCL180, MCKCL250, MCKCL2500		
Spring Hinges		
1502, 1552	71	For 4½" height
1502	71F, 71G	F For 4" G For 3½" Size height
Economical Steel Door Spring	72	
451, 452, 453		
Rescue Hardware & Center Hung Pivot & PH4	11	
CSS-9, DS-6, DLS-8, EP-5J, PH-4		
Residential Grade Hinges	14	
1400, 1414, 1458		
Miscellaneous	15- No Discount unless noted on Buying Program	

McKinney
ASSA ABLOY

Experience a safer
and more open world

800 346 7707 | www.mckinneyhinge.com
USA Prices Effective March 1, 2024

Standard Weight 3 Knuckle Non-Ferrous Bearings

TA314

Price Code 30

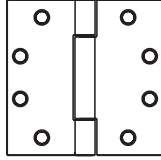

Size	Part Number	Finish	Price Each	Box Qty.	Case Qty.	Case Wgt.	Q S
3 1/2" x 3 1/2" 88.90 mm x 88.90 mm	69320	26	\$38.00	3	48	33	
	69323	32D	\$30.00				
4" x 4" 101.60 mm x 101.60 mm	69327	26D	\$35.00	3	48	46	
	69338	32D	\$35.00				
4 1/2" x 4" 114.30 mm x 101.60 mm	69345	4	\$46.00	3	48	53	
	69346	10	\$46.00				
	69347	10B	\$53.00				
	69354	32	\$46.00				
	69353	32D	\$38.00				
4 1/2" x 4" 114.30 mm x 101.60 mm	56402	32D-NRP	\$42.00	3	48	53	✓
4 1/2" x 4 1/2" 114.30 mm x 114.30 mm	69360	4	\$50.00	3	48	57	
	69362	10B	\$57.00				
	69365	26	\$50.00				
	69369	32	\$50.00				
	69369FT	32-FT	\$72.00				
	69368	32D	\$42.00				
4 1/2" x 4 1/2" 114.30 mm x 114.30 mm NRP	69356	32D-NRP	\$46.00	3	48	57	✓
5" x 4" 127 mm x 101.60 mm	73889	26	\$56.00	3	24	33	
	73890	32	\$56.00				
	73881	32D	\$48.00				
	73891	32D-NRP	\$52.00				
5" x 4 1/2" 127 mm x 114.30 mm	69380	26	\$63.00	3	24	36	
	69372	26D	\$55.00				
	69383	32D	\$55.00				
	69384	32	\$63.00				
5" x 5" 127 mm x 127 mm	69399	32	\$69.00	3	24	36	

Standard Weight 3 Knuckle Hospital Tip Non-Ferrous Bearings

TA314

Price Code 30

Part Number	Finish	Price Each	Box Qty.	Case Qty.	Case Wgt.	Q S
4 1/2" x 4" 114.30 mm x 101.60 mm						
69489	32D	\$54.00	3	48	53	✓
4 1/2" x 4 1/2" 114.30 mm x 114.30 mm						
69363	32D	\$58.00	3	48	57	✓

Heavy Weight 3 Knuckle

TA386

Price Code 30

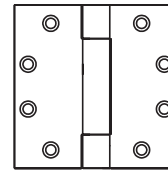

Size	Part Number	Finish	Price Each	Box Qty.	Case Qty.	Case Wgt.	Q S
4 1/2" x 4" 114.30 mm x 101.60 mm (NRP)	69396	32D-NRP	\$72.00	3	24	37	✓
	69411	32D	\$68.00				✓
	82100	26D-NRP	\$80.00				
4 1/2" x 4 1/2" 114.30 mm x 114.30 mm	69405	4	\$76.00	3	24	36	
	69406	10	\$76.00				
	69407	10B	\$83.00				
	69410	26	\$76.00				
	69414	32	\$76.00				
	69413	32D	\$68.00				
4 1/2" x 4 1/2" 114.30 mm x 114.30 mm (NRP)	69415	32D-NRP	\$72.00	3	24	36	✓
5" x 4" 127 mm x 101.60 mm	74941	32D	\$87.50				✓
5" x 4 1/2" 127 mm x 114.30 mm	69427	3	\$104.50	3	24	41	
	69420	4	\$104.50				
	69422	10B	\$111.50				
	69417	26D	\$104.50				
	69428	32D	\$96.50				
5" x 4 1/2" 127 mm x 114.30 mm (NRP)	69430	26D-NRP	\$108.50	3	24	41	
	74956	32D-NRP	\$100.50				✓
5" x 5" 127 mm x 127 mm	69437	10B	\$125.50	3	24	45	
	69443	32D	\$110.50				

Size	Part Number	Finish	Price Each	Box Qty.	Case Qty.	Case Wgt.	Q S
TA386 Price Code 30							
4 1/2" x 6" 114.30 mm x 152.40 mm	-	32D	\$155.00	3	24	60	

Hospital Tip Heavy Weight 3 Knuckle Non-Ferrous Bearings

Stainless Steel Institutional Hinges

Size	Part Number	Finish	Price Each	Box Qty.	Case Qty.	Case Wgt.	Q S
HTA386 Price Code 30							
4 1/2" x 4" 114.30 mm x 101.60 mm	69446	32D	\$84.00	3	24	41	✓
4 1/2" x 4 1/2" 114.30 mm x 114.30 mm	81306	32D	\$84.00	3	24	37	✓
5" x 4" 127 mm x 101.60 mm	74942	32D	\$103.50	3	24	41	✓

Size	Part Number	Finish	Price Each	Box Qty.	Case Qty.	Case Wgt.	Q S
HTA386 x PSF Price Code 30							
4 1/2" x 4 1/2" 114.30 mm x 114.30 mm	81535	32D	\$154.50	3	24	40	✓

If Torx Security Screws are required please specify Machine or Wood when ordering.

Steel Standard Weight 3 Knuckle Bearing

TA714

Price Code 30

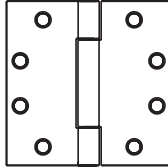

Size	Part Number	Finish	Price Each	Box Qty.	Case Qty.	Case Wgt.	Q S
3 1/2" x 3 1/2" 88.90 mm x 88.90 mm							
	69190	10A	\$24.75	3	48	31	✓
	69182	10B	\$31.75				✓
	69188	15	\$24.75				✓
	69185	26	\$24.75				✓
	69177	26D	\$16.75				✓
4" x 4" 101.60 mm x 101.60 mm							
	69195	4	\$24.75	3	48	42	✓
	69197	10B	\$31.75				✓
	69200	26	\$24.75				✓
	69192	26D	\$16.75				✓
4 1/2" x 4" 114.30 mm x 101.60 mm							
	69217	3	\$24.75	3	48	51	✓
	69210	4	\$24.75				✓
	69211	10	\$24.75				✓
	69176	10A	\$24.75				✓
	69212	10B	\$31.75				✓
	56403	15	\$24.75				✓
	56540	BSP	\$31.75				✓
	69215	26	\$24.75				✓
	69207	26D	\$16.75				✓
	74201	26D-NRP	\$19.00				✓
4 1/2" x 4 1/2" 114.30 mm x 114.30 mm							
	56407	15-NRP	\$27.00	3	48	55	✓
	56510	BSP	\$31.75				✓
	69223	P	\$16.75				✓
	69232	3	\$24.75				✓
	69225	4	\$24.75				✓
	69226	10	\$24.75				✓
	69236	10A	\$24.75				✓
	69227	10B	\$31.75				✓
	69227E	10BE	\$24.75				✓
	69228	15	\$24.75				✓
	69230	26	\$24.75				✓

Continued on next column

Size	Part Number	Finish	Price Each	Box Qty.	Case Qty.	Case Wgt.	Q S
4 1/2" x 4 1/2" 114.30 mm x 114.30 mm							
	69222	26D	\$16.75	3	48	55	✓
	69222FT	26D-FT	\$38.75				✓
	69222FTN	26D-NRP-FT	\$41.00				✓
	74284	D4	\$24.75	✓			
4 1/2" x 4 1/2" 114.30 mm x 114.30 mm (NRP)							
	74283	26D-NRP	\$19.00	3	48	55	✓
	69251	3-NRP	\$27.00				✓
	74200	10-NRP	\$27.00				✓
	74281	26-NRP	\$27.00				✓
	74282	10B-NRP	\$34.00				✓

Steel Standard Weight 3 Knuckle Bearing

TA714

Price Code 30

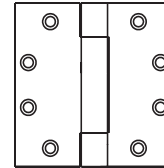

Size	Part Number	Finish	Price Each	Box Qty.	Case Qty.	Case Wgt.	Q S
5" x 4" 127 mm x 101.60 mm							
	69625	26D	\$24.75	3	24	32	✓
5" x 4 1/2" 127 mm x 114.30 mm							
	69247	3	\$36.75	3	24	32	✓
	69240	4	\$36.75				✓
	69311	10A	\$36.75				✓
	69242	10B	\$43.75				✓
	69245	26	\$36.75				✓
	69237	26D	\$28.75				✓
	69246	26D-NRP	\$31.00	✓			
5" x 5" 127 mm x 127 mm							
	69262	3	\$41.75	3	24	34	✓
	69257	10B	\$48.75				✓
	69252	26D	\$33.75				✓



Experience a safer and more open world

800 346 7707 | www.mckinneyhinge.com
USA Prices Effective March 1, 2024

Copyright © 2024, ASSA ABLOY Accessories and Door Controls Group, Inc. All rights reserved. Reproduction in whole or in part without the express written permission of ASSA ABLOY Accessories and Door Controls Group, Inc. is prohibited.

Hospital Tip HTA714 Price Code 30

Size	Part Number	Finish	Price Each	Box Qty.	Case Qty.	Case Wgt.	Q	S
4 1/2" x 4" 114.30 mm x 101.60 mm	74350	26D	\$32.75	3	48	55	✓	
4 1/2" x 4 1/2" 114.30 mm x 114.30 mm	69233	26D	\$32.75	3	48	55	✓	
5" x 4 1/2" 127 mm x 114.30 mm	74368	26D	\$44.75	3	48	55		

Steel Standard Weight 3 Knuckle Bearing Wide Throw

TA714 Price Code 30

Size	Part Number	Finish	Price Each	Box Qty.	Case Qty.	Case Wgt.	Q	S
4 1/2" x 6" 114.30 mm x 152.4 mm	74373	26D	\$32.50	3	24	39		

Same Prices for up to 4 1/2" x 8"

Steel Heavy Weight 3 Knuckle Bearing

TA786
Price Code 30

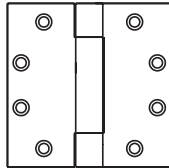

Size	Part Number	Finish	Price Each	Box Qty.	Case Qty.	Case Wgt.	Q	S
4 1/2" x 4" 114.30 mm x 101.60 mm	56400	26D	\$41.00	3	24	37	✓	✓
	56401	26D-NRP	\$45.00					
	56404	15	\$49.00					
	69270	4	\$49.00					
4 1/2" x 4 1/2" 114.30 mm x 114.30 mm	69271	10	\$49.00	3	24	37	✓	✓
	75282	10A	\$49.00					
	69272	10B	\$56.00					
	69276	15	\$49.00					
	69275	26	\$49.00					
	69267	26D	\$41.00					
	69267FT	26D-FT	\$63.00					
	69281	10B-NRP	\$60.00					
4 1/2" x 4 1/2"-NRP 114.30 mm x 114.30 mm	75235	15-NRP	\$53.00	3	24	37	✓	✓
	75240	26D-NRP	\$45.00					
	69278	15	\$61.50					
5" x 4" 127 mm x 101.60 mm	69279	26D	\$53.50	3	24	39	✓	✓
5" x 4 1/2" 127 mm x 114.30 mm	69285	4	\$66.50					
	69287	10B	\$73.50					
	69290	26	\$66.50					
5" x 5" 127 mm x 127 mm	69282	26D	\$58.50	3	24	42	✓	✓
	69295	26D-NRP	\$62.50					
	69300	4	\$71.50					
6" x 6"* 152.40 mm x 152.40 mm	69302	10B	\$78.50	3	18	62	✓	✓
	69297	26D	\$63.50					
	75317	4	\$133.00					
	75323	26	\$133.00					
	75324	26D	\$125.00					

* For 6" x 4 1/2" or 6" x 5" use price of 6" x 6"

Steel Heavy Weight 3 Knuckle Hospital Tip

HTA786
Price Code 30

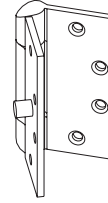

Size	Part Number	Finish	Price Each	Box Qty.	Case Qty.	Case Wgt.	Q	S
4 1/2" x 4" 114.30 mm x 101.60 mm	75230	26D	\$57.00	3	24	35		
4 1/2" x 4 1/2" 114.30 mm x 114.30 mm	75232	26D	\$57.00	3	24	35	✓	✓
	75244	26D x PSF	\$85.00					
5" x 4 1/2" 127 mm x 114.30 mm	75233	26D	\$74.50	3	24	35	✓	✓

If Torx Security Screws are required please specify Machine or Wood when ordering.

Steel Swing Clear Heavy Weight 3 Knuckle Bearing – Reversible

TA795
Price Code 30

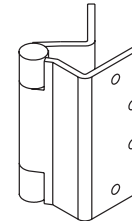

Size	Part Number	Finish	Price Each	Box Qty.	Case Qty.	Case Wgt.	Q	S
4 1/2" 114.30 mm	75476	26D	\$116.00	3	24	57	✓	✓
5" 127 mm	75381	26D	\$128.50	3	24	57	✓	✓

For swing clear heavy weight three knuckle bearing, beveled edge application order TA5795. (Hinges are reversible and non-handed.)

Hospital Tip Bearing

HTA795
Price Code 30

Part Number	Finish	Price Each	Box Qty.	Case Qty.	Case Wgt.	Q	S
4 1/2" 114.30 mm							
75464	26D	\$132.00	3	24	57	✓	✓
5" 127 mm							
75382	26D	\$144.50	3	24	57	✓	✓

Non-Ferrous Standard Weight 5 Knuckle

T2314

Price Code 50

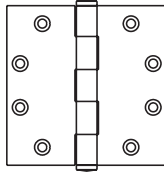

Size	Part Number	Finish	Price Each	Box Qty.	Case Qty.	Case Wgt.	Q	S
3 1/2" x 3 1/2" 88.90 mm x 88.90 mm	58836	10B	\$34.00	2	48	35		
	59595	26D	\$19.00					
	58845	32D	\$19.00					
4" x 4" 101.60 mm x 101.60 mm	59646	10B	\$39.00	3	48	44		✓
	59657	26D	\$24.00					
	59661	32D	\$24.00					
4 1/2" x 4" 114.30 mm x 101.60 mm	59733	10B	\$42.00	3	48	47		

Continued on next column

Size	Part Number	Finish	Price Each	Box Qty.	Case Qty.	Case Wgt.	Q	S
4 1/2" x 4 1/2" 114.30 mm x 114.30 mm	58972	10B	\$46.00	3	48	52		✓
	59797	26D	\$31.00					
	58963	32	\$39.00					
	58964	32D	\$31.00					
4 1/2" x 4 1/2"-NRP 114.30 mm x 114.30 mm	59804	10B-NRP	\$50.00	3	48	52		✓
	59784	26D-NRP	\$35.00					
	58965	32D-NRP	\$35.00					
5" x 5" 127 mm x 127 mm	59940	26D	\$49.00	3	24	35		
	59192	32D	\$49.00					

Non-Ferrous Standard Weight 5 Knuckle Bearing

TA2314

Price Code 50

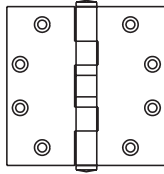

Size	Part Number	Finish	Price Each	Box Qty.	Case Qty.	Case Wgt.	Q	S
3 1/2" x 3 1/2" 88.90 mm x 88.90 mm	61022	4	\$31.00	3	48	33		✓
	61015	10B	\$38.00					
	59611	26	\$31.00					
	59630	26D	\$23.00					
4" x 4" 101.60 mm x 101.60 mm	61026	32D	\$23.00	3	48	46		✓
	59681	3	\$36.00					
	59677	4	\$36.00					
	59680	10B	\$43.00					
	59678	32D	\$28.00					
4 1/2" x 4" 114.30 mm x 101.60 mm	59692	32D-NRP	\$32.00	3	48	53		✓
	59754	3	\$39.00					
	59759	4	\$39.00					
	59745	10	\$39.00					
	59746	10B	\$46.00					
	59757	26	\$39.00					
	59751	32	\$39.00					
	59752	32D	\$31.00					
4 1/2" x 4"-NRP 114.30 mm x 101.60 mm	59755	26D-NRP	\$35.00	3	48	53		✓
	59756	32D-NRP	\$35.00					
	59741	10B-NRP	\$50.00					
	59820	P	\$35.00					
4 1/2" x 4 1/2" 114.30 mm x 114.30 mm	59826	3	\$43.00	3	48	57		✓
	59822	4	\$43.00					
	59828	10	\$43.00					
	59829	10A	\$43.00					
	56517	BSP	\$50.00					
	59838C	CPC (SS)	\$49.00					
	59839	10B	\$50.00					
	59839S	10B (SS)	\$50.00					
	59839E	10BE (SS)	\$50.00					
	59830	26	\$43.00					

Continued on next column

Size	Part Number	Finish	Price Each	Box Qty.	Case Qty.	Case Wgt.	Q	S
4 1/2" x 4 1/2" 114.30 mm x 114.30 mm	59832	26D	\$35.00	3	48	57		✓
	59823	32	\$43.00					
	59838	32D	\$35.00					
4 1/2" x 4 1/2" 114.30 mm x 114.30 mm	59821	P-NRP	\$39.00	3	48	57		✓
	59844	3-NRP	\$47.00					
	59835	10-NRP	\$47.00					
	76001	10B-NRP	\$54.00					
	59837	26D-NRP	\$39.00					
	59840	32D-NRP	\$39.00					
	59847	32D-NRP-SSF	\$54.00					
5" x 4" 127 mm x 101.60 mm	59996	26	\$48.00	3	24	33		✓
	59997	26D	\$40.00					
	59999	32D	\$40.00					
5" x 4 1/2" 127 mm x 114.30 mm	60015	4	\$55.00	3	24	36		✓
	59906	10B	\$62.00					
	59904	32D	\$47.00					
5" x 4 1/2"-NRP 127 mm x 114.30 mm	59905	26D-NRP	\$51.00	3	24	36		✓
	59910	32D-NRP	\$51.00					
	59911	10B-NRP	\$66.00					
5" x 5" 127 mm x 127 mm	59967	4	\$61.00	3	24	38		✓
	59966	10B	\$68.00					
	59977	26D	\$53.00					
	59984	32D	\$53.00					
	59984	32D	\$53.00					

HTA2314 Price Code 50

Size	Part Number	Finish	Price Each	Box Qty.	Case Qty.	Case Wgt.	Q	S
4 1/2" x 4" 114.30 mm x 101.60 mm	59807	32D	\$47.00					✓
4 1/2" x 4 1/2" 114.30 mm x 114.30 mm	59808	32D	\$51.00					✓

McKinney
ASSA ABLOY

Experience a safer
and more open world

800 346 7707 | www.mckinneyhinge.com
USA Prices Effective March 1, 2024

Copyright © 2024, ASSA ABLOY Accessories and Door Controls Group, Inc. All rights reserved. Reproduction in whole or in part without the express written permission of ASSA ABLOY Accessories and Door Controls Group, Inc. is prohibited.

Non-Ferrous Standard Weight 5 Knuckle Concealed Bearing

TCA2314
Price Code 50

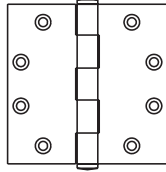

Size	Part Number	Finish	Price Each	Box Qty.	Case Qty.	Case Wgt.	Q	S
4 1/2" x 4 1/2" 114.30 mm x 114.30 mm	68972	4	\$104.00	3	48	57		
	68974	10B	\$111.00					
	68976	26D	\$96.00					
	68983	32D	\$96.00					

Non-Ferrous Standard Weight 5 Knuckle Concealed Bearing

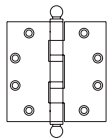

Non-Ferrous Standard Weight 5 Knuckle Ball Tip

4 1/2" x 4 1/2" 114.30 mm x 114.30 mm

Part Number	Finish	Price Each	Box Qty.	Case Qty.	Case Wgt.	Q	S
59815	10B	\$72.00	3	48	59		

TA2314BT
Price Code 50

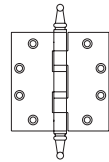

Non-Ferrous Standard Weight 5 Knuckle Steeple Tip

4 1/2" x 4 1/2" 114.30 mm x 114.30 mm

Part Number	Finish	Price Each	Box Qty.	Case Qty.	Case Wgt.	Q	S
59816	3	\$65.00	3	48	59		

TA2314ST
Price Code 50

Non-Ferrous Swing Clear Standard Weight

TA2395 Price Code 50

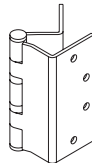

Size	Part Number	Finish	Price Each	Box Qty.	Case Qty.	Case Wgt.	Q	S
4 1/2" 114.30 mm	56985	32D	\$117.00	3	24	40		
5" 127 mm Hinges are NRP and Reversible.	73585	32D	\$126.00	3	24	40		

Non-Ferrous Standard Weight 5 Knuckle Wide Throw

TA2398 Price Code 50

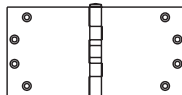

Size	Part Number	Finish	Price Each	Box Qty.	Case Qty.	Case Wgt.	Q	S
4 1/2" x 6" 114.30 mm x 152.40 mm	62624	32D	\$115.00	3	24	42		

Steel Standard Weight 5 Knuckle

T2714
Price Code 50

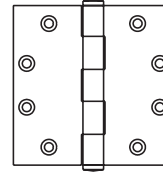

Size	Part Number	Finish	Price Each	Box Qty.	Case Qty.	Case Wgt.	Q	S						
3 1/2" x 3 1/2" 88.90 mm x 88.90 mm	55315	P	\$8.75	2	48	31		✓						
	55317	3	\$16.75											
	55337	4	\$16.75											
	55321	10	\$16.75											
	55330	10A	\$16.75											
	55333	10B	\$23.75											
	55430	RC-10B	\$28.75											
	56524	RC-BSP	\$28.75											
	55333E	10BE	\$16.75											
	55314	15	\$16.75											
	55327	26	\$16.75											
	55319	26D	\$8.75											
	55348	10B-BT	\$45.75											
	55438	RC-26D	\$13.75											
	55380	D4	\$16.75											
	55443	RC-D4	\$21.75											
	56502	BSP	\$23.75											
	56522	WSP	\$23.75											
3 1/2" x 3 1/2" 88.90 mm x 88.90 mm (RHP)	55397	26D	\$10.75	2	48	31		✓						
	Reverse Hole Pattern													
4" x 4" 101.60 mm x 101.60 mm	55485	P	\$8.75	3	48	41		✓						
	55491	3	\$16.75											
	55487	4	\$16.75											
	55509	D4	\$16.75											
	69829	RC-10B	\$28.75											
	56515	BSP	\$23.75											
	56525	RC-BSP	\$28.75											
	55521	RC-26D	\$13.75											
	55496	10B	\$23.75											
	55497	15	\$16.75											
	55499	26	\$16.75											
	55501	26D	\$8.75											
	4 1/2" x 4" 114.30 mm x 101.60 mm	55635	P						\$8.75	3	48	50		✓
		55648	4						\$16.75					
		55637	10						\$16.75					
55644		10B	\$23.75											
55656		15	\$16.75											
55655		26	\$16.75											
55639		26D	\$8.75											
56543	WSP	\$23.75												

Continued on next page

McKinney
ASSA ABLOY

Experience a safer
and more open world

FM-5

Steel Standard Weight 5 Knuckle

T2714 Price Code 50

Continued...

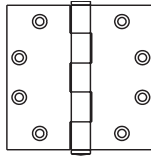

Size	Part Number	Finish	Price Each	Box Qty.	Case Qty.	Case Wgt.	Q	S
4 1/2" x 4" (NRP) 114.30 mm x 101.60 mm	55645	P-NRP	\$11.00	3	48	50		
	55657	26D-NRP	\$11.00					
4 1/2" x 4 1/2" (NRP) 114.30 mm x 114.30 mm	55745	P	\$8.75	3	48	54		✓
	55771	3	\$16.75					✓
	55767	4	\$16.75					✓
	55774	10	\$16.75					✓
	55762	10A	\$16.75					✓
	55742	10B	\$23.75					✓
	55742E	10BE	\$16.75					✓
	55751	15	\$16.75					✓
	55753	26	\$16.75					✓
	55755	26D	\$8.75					✓
	55783	D4	\$16.75					✓
	56539	BSP	\$23.75					
	4 1/2" x 4 1/2" (NRP) 114.30 mm x 114.30 mm	55747	P-NRP					\$11.00
55768		4-NRP	\$19.00	✓				
55752		10B-NRP	\$26.00	✓				
55778		26D-NRP	\$11.00	✓				
5" x 4 1/2" 127 mm x 114.30 mm	55988	3	\$27.25	3	24	31		
	70044	4	\$27.75					
	70049	26	\$27.75					
	55972	26D	\$19.75					✓
5" x 5" 127 mm x 127 mm	56080	P	\$24.75	3	24	34		
	56084	26D	\$24.75					
	56503	BSP	\$39.75					✓
	56523	WSP	\$39.75					

Hinge Pin Stop Price Code 50

For 4 1/2" Size T2714 & TA2714

Part No.	Finish	Price Each	Description	Box Qty.	Case Qty.	Case Wgt.	Q	S
76306	26D	\$10.00	Hinge Pin Stop	6	96			✓
76308	BSP	\$13.00	Hinge Pin Stop					

Size	Part Number	Finish	Price Each	Box Qty.	Case Qty.	Case Wgt.	Q	S
------	-------------	--------	------------	----------	-----------	-----------	---	---

RCTA2714 Price Code 50

4" x 4" 101.60 mm x 101.60 mm	55632	26D	\$14.25					✓
	69824	10A	\$22.25					✓

Steel Standard Weight 5 Knuckle Bearing

TA2714

Price Code 50

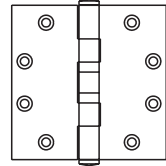

Size	Part Number	Finish	Price Each	Box Qty.	Case Qty.	Case Wgt.	Q	S					
3 1/2" x 3 1/2" 88.90 mm x 88.90 mm	55385	P	\$9.25	3	48	31		✓					
	55391	3	\$17.25					✓					
	55387	4	\$17.25										
	55395	10	\$17.25					✓					
	55401	10A	\$17.25										
	55389	10B	\$24.25					✓					
	55402	26	\$17.25										
	55393	26D	\$9.25					✓					
	55392	15	\$17.25										
	4" x 4" 101.60 mm x 101.60 mm	55555	P					\$9.25	3	48	42		
		55561	3					\$17.25					✓
		55557	4					\$17.25					
		55563	10					\$17.25					✓
55554		10A	\$17.25										
55577		10B	\$24.25	✓									
55569		26	\$17.25	✓									
55571		26D	\$9.25	✓									
55567		15	\$17.25	✓									
56538		BSP	\$24.25										
4 1/2" x 4" 114.30 mm x 101.60 mm		55675	P	\$9.25	3	48	51						✓
		55683	3	\$17.25									✓
		55674	4	\$17.25									✓
	55681	10	\$17.25	✓									
	55673	10A	\$17.25	✓									
	55691	10B	\$24.25	✓									
	55691E	10BE	\$17.25	✓									
	55616	15	\$17.25	✓									
	55688	26	\$17.25	✓									
	55679	26D	\$9.25	✓									
	55587	D3	\$17.25										
	55588	D4	\$17.25										
	55797	RC-26D*	\$14.25	✓									
	56507	BSP	\$24.25	✓									
	56542	WSP	\$24.25										
	4 1/2" x 4" (NRP) 114.30 mm x 101.60 mm	55693	P-NRP	\$11.50					3	48	51		
		55690	26D-NRP	\$11.50									✓
		55682	10A-NRP	\$19.50									
		55689	10B-NRP	\$26.50									
55798		RC-26D NRP*	\$16.50	✓									
55802		RC-D4-NRP*	\$24.50	✓									

*Round Corner.

Continued on next page

McKinney
ASSA ABLOY

Experience a safer
and more open world

Steel Standard Weight 5 Knuckle Bearing

TA2714 Price Code 50

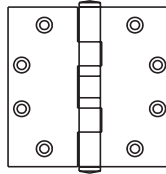

Continued...

Size	Part Number	Finish	Price Each	Box Qty.	Case Qty.	Case Wgt.	Q S				
4 1/2" x 4 1/2" 114.30 mm x 114.30 mm	55820	P	\$9.25	3	48	55	✓				
	55846	3	\$17.25				✓				
	55842	4	\$17.25				✓				
	55841	5	\$17.25				✓				
	55844	9	\$17.25				✓				
	55848	10	\$17.25				✓				
	55847	10A	\$17.25				✓				
	55862	10B	\$24.25				✓				
	55862E	10BE	\$17.25				✓				
	55852	14	\$17.25				✓				
	56106	10B-BT	\$46.25				✓				
	55854	15	\$17.25				✓				
	55856	26	\$17.25				✓				
	55858	26D	\$9.25				✓				
	55809	D3	\$17.25								
	55810	D4	\$17.25								
	56500	BSP	\$24.25				✓				
	56520	WSP	\$24.25								
	4 1/2" x 4 1/2" 114.30 mm x 114.30 mm (NRP)	55822	P-NRP				\$11.50	3	48	55	✓
		55853	3-NRP				\$19.50				✓
55834		4-NRP	\$19.50	✓							
55850		10-NRP	\$19.50	✓							
55851		10A-NRP	\$19.50	✓							
55875		10B-NRP	\$26.50	✓							
55875E		10BE-NRP	\$19.50	✓							
55903		15-NRP	\$19.50	✓							
56526		BSP-NRP	\$26.50	✓							
55870		26-NRP	\$19.50	✓							
55860		26D-NRP	\$11.50	✓							
55814		D3-NRP	\$19.50								
55812	D4-NRP	\$19.50	✓								

Continued on next column

Size	Part Number	Finish	Price Each	Box Qty.	Case Qty.	Case Wgt.	Q S				
5" x 4" 127 mm x 101.60 mm	55962	26D	\$16.75	3	24	29	✓				
	5" x 4 1/2" 127 mm x 114.30 mm	56010	P	\$20.75	3	24	32				
		56011	3	\$28.75				✓			
		56013	4	\$28.75							
		56014	10	\$28.75				✓			
		56026	10B	\$35.75				✓			
		56021	15	\$28.75				✓			
		56018	26	\$28.75				✓			
		56020	26D	\$20.75				✓			
		5" x 4 1/2" 127 mm x 114.30 mm (NRP)	56012	P-NRP				\$23.00	3	24	34
56030			26D-NRP	\$23.00				✓			
5" x 5" 127 mm x 127 mm	56120	P	\$25.75	3	24	34					
	56122	P-NRP	\$28.00								
	56139	3	\$33.75				✓				
	56135	4	\$33.75				✓				
	56141	10	\$33.75								
	56148	10A	\$33.75								
	56155	10B	\$40.75				✓				
	56145	15	\$33.75				✓				
	56147	26	\$33.75				✓				
6" x 6" 152.4 mm x 152.4 mm	56149	26D	\$25.75	3	18	55	✓				
	56252	10A	\$65.50								
	56244	10B	\$72.50								
	56248	26D	\$57.50								

Steel Standard Weight 5 Knuckle Concealed Bearing

TCA2714 Price Code 50

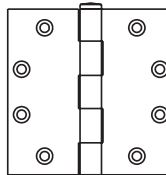

Size	Part Number	Finish	Price Each	Box Qty.	Case Qty.	Case Wgt.	Q S
4 1/2" x 4" 114.30 mm x 101.60 mm	67208	3	\$39.25	3	48	51	
	67202	4	\$39.25				
	67211	26	\$39.25				
	67206	26D	\$31.25				✓
	67214	D4	\$39.25				
4 1/2" x 4 1/2" 114.30 mm x 114.30 mm	67228	3	\$39.25	3	48	55	
	67222	4	\$39.25				
	67223	10	\$39.25				
	67235	10A	\$39.25				
	67224	10B	\$46.25				
	67239	10B-NRP	\$48.50				
	67226	26D	\$31.25				✓
	69700	26D-NRP	\$33.50				✓

Size	Part Number	Finish	Price Each	Box Qty.	Case Qty.	Case Wgt.	Q S
5" x 4 1/2" 127 mm x 114.30 mm	67248	3	\$50.75	3	24	32	
	67242	4	\$50.75				
	67243	10	\$50.75				
	67251	26	\$50.75				
	67246	26D	\$42.75				✓
5" x 5" 127 mm x 127 mm	67263	10	\$55.75	3	24	32	
	67264	10B	\$62.75				

800 346 7707 | www.mckinneyhinge.com
USA Prices Effective March 1, 2024

Copyright © 2024, ASSA ABLOY Accessories and Door Controls Group, Inc. All rights reserved. Reproduction in whole or in part without the express written permission of ASSA ABLOY Accessories and Door Controls Group, Inc. is prohibited.

McKinney
ASSA ABLOY

Experience a safer
and more open world

FM-7

Steel Standard Weight 5 Knuckle Hospital Tip Bearing

HTA2714

Price Code 50

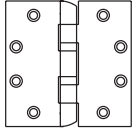

Part Number	Finish	Price Each	Box Qty.	Case Qty.	Case Wgt.	Q	S
4 1/2" x 4" 114.30 mm x 101.60 mm							
55819	26D	\$25.25	3	48	55	✓	
4 1/2" x 4 1/2" 114.30 mm x 114.30 mm							
55849	10	\$33.25	3	48	55		
55859	26D	\$25.25					
5" x 4 1/2" 127 mm x 114.30 mm							
56035	15	\$44.75	3	48	32	✓	

Steel Standard Weight 5 Knuckle Bearing Safety Stud

TA2714-SSF

Price Code 50

Part Number	Finish	Price Each	Box Qty.	Case Qty.	Case Wgt.	Q	S
4 1/2" x 4 1/2" 114.30 mm x 114.30 mm NRP							
55861	26D NRP	\$26.50	3	48	55	✓	

Steel Standard Weight 2 Knuckle Bearing

TA2731

Price Code 20

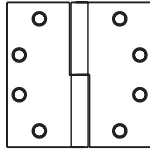

Part Number	Finish	Price Each	Hand	Box Qty.	Case Qty.	Case Wgt.	Q	S					
4 1/2" x 4" 114.30 mm x 101.60 mm													
65599	10B	\$32.75	RH	3	48	46							
65598	10B	\$32.75	LH										
65594	26	\$25.75	RH										
65595	26	\$25.75	LH										
65579	26D	\$17.75	RH										
65580	26D	\$17.75	LH										
65585	D3	\$25.75	RH										
65586	D3	\$25.75	LH										
65587	D4	\$25.75	RH										
65588	D4	\$25.75	LH										
4 1/2" x 4 1/2" 114.30 mm x 114.30 mm													
65631	15	\$27.75	R.H.	3	48	49		✓					
65632	15	\$27.75	L.H.										
65617	10	\$27.75	R.H.										
65618	10	\$27.75	L.H.										
65636	10B	\$34.75	R.H.										
65635	10B	\$34.75	L.H.										
65634	26	\$27.75	R.H.										
65637	26	\$27.75	L.H.										
65623	26D	\$19.75	R.H.										
65624	26D	\$19.75	L.H.										
65629	D4	\$27.75	R.H.										
65630	D4	\$27.75	L.H.										
5" x 5" 127 mm x 127 mm													
65767	26D	\$48.75	R.H.						3	24	32		
65768	26D	\$48.75	L.H.										

Steel Standard Weight Wide Throw 5 Knuckle Bearing

TA2798

Price Code 50

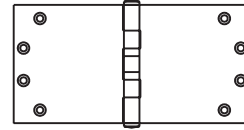

Size	Part Number	Finish	Price Each	Box Qty.	Case Qty.	Case Wgt.	Q	S					
3 1/2" x 6" 88.90 mm x 152.4 mm	65323	P	\$60.00	3	24	30							
	4 1/2" x 6"	59046	P	\$80.00	3	24	39						
		65393	3	\$88.00									
65394	4	\$88.00											
59054	10	\$88.00											
65397	10B	\$95.00											
65400	26	\$88.00											
59052	26D	\$80.00									✓		
4 1/2" x 7" 114.30 mm x 177.8 mm	59099	4	\$93.00	3						24	42		
	59104	10B	\$100.00										
62542	26D	\$85.00											
4 1/2" x 8" 114.30 mm x 203.2 mm	62554	10B	\$105.00	3	24	48							
	62558	26D	\$90.00										
5" x 7" 127 mm x 177.8 mm	62578	10B	\$110.00	3	24	51							

McKinney
ASSA ABLOY

Experience a safer
and more open world

Steel Standard Weight Swing Clear 5 Knuckle Bearing

TA2895
Price Code 50

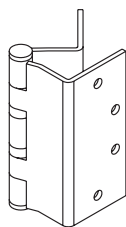

Size	Part Number	Finish	Price Each	Box Qty.	Case Qty.	Case Wgt.	Q S
4 1/2" 114.30 mm Hinges are NRP, reversible and non-handed.	57002	4	\$84.25	3	24	38	
	57003	10	\$84.25				
	57004	10B	\$91.25				
	57006	26D	\$76.25				✓
5" 127 mm	57030	26D	\$83.75	3	24	40	✓

Steel Standard Weight Swing Clear 5 Knuckle Bearing For Beveled Edge Doors

TA4895
Price Code 50

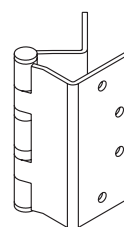

Size	Part Number	Finish	Price Each	Box Qty.	Case Qty.	Case Wgt.	Q S
4 1/2" 114.30 mm Hinges are NRP, reversible and non-handed.	57046	10B	\$115.25	3	24	38	
	57041	26D	\$100.25				✓
	57049	26D	\$107.75				3

Non-Ferrous Standard Weight 2 Knuckle Bearing

TA3331
Price Code 20

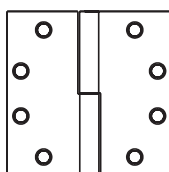

Part Number	Finish	Price Each	Hand	Box Qty.	Case Qty.	Case Wgt.	Q S
4" x 4" 101.60 mm x 101.60 mm							
70270	32D	\$34.00	R.H.	3	48	46	
70271	32D	\$34.00	L.H.				
4 1/2" x 4" 114.30 mm x 101.60 mm							
66297	32D	\$39.00	R.H.	3	48	53	
66298	32D	\$39.00	L.H.				
4 1/2" x 4 1/2" 114.30 mm x 114.30 mm							
66335	32D	\$44.00	R.H.	3	48	57	
66336	32D	\$44.00	L.H.				

Non-Ferrous Heavy Weight 2 Knuckle Bearing

TA3350
Price Code 20

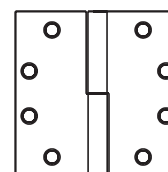

Part Number	Finish	Price Each	Hand	Box Qty.	Case Qty.	Case Wgt.	Q S
4 1/2" x 4 1/2" 114.30 mm x 114.30 mm							
66639	32D	\$125.00	R.H.	3	24	37	
66640	32D	\$125.00	L.H.				

Custom Hinges to fit REDIFRAME

SPL TA2895 Price Code 50

Size	Part Number	Finish	Price Each	Q S
4 1/2" 114.30 mm	57006SP	26D	\$76.25	✓

Non-Ferrous Heavy Weight 5 Knuckle Bearing

T4A3386
Price Code 50

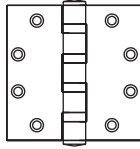

Size	Part Number	Finish	Price Each	Box Qty.	Case Qty.	Case Wgt.	Q S	
4 1/2" x 4" 114.30 mm x 101.60 mm	61779	32D	\$60.00	3	24	37	✓	
4 1/2" x 4" (NRP) 114.30 mm x 101.60 mm	61772	32D-NRP	\$64.00	3	24	37	✓	
<i>Hospital Tip</i>	61773	32D-HT	\$76.00	3	24	37	✓	
4 1/2" x 4 1/2" 114.30 mm x 114.30 mm	61801	P	\$68.00	3	24	37		
	61794	3	\$68.00				✓	
	61790	4	\$68.00				✓	
	61796	10	\$68.00				✓	
	61793	10A	\$68.00					
	61795	10B	\$75.00				✓	
	61802	26	\$68.00					
	61791	32	\$68.00				✓	
	61787	32D	\$60.00				✓	
	61795E	10BE (SS)	\$68.00				✓	
	61795S	10B (SS)	\$75.00				✓	
	<i>Hospital Tip</i>	61820	32D-HT				\$76.00	✓
	4 1/2" x 4 1/2" (NRP) 114.30 mm x 114.30 mm	61815	10B-NRP				\$79.00	3
61812		26D-NRP	\$72.00	✓				
61813		10-NRP	\$72.00	✓				
61814		32D-NRP	\$64.00	✓				
61780		32D-NRP-SSF	\$79.00	✓				
5" x 4" 127 mm x 101.60 mm	58437	32D	\$78.50	3	24	37	✓	
	61867	32D-NRP	\$82.50					
5" x 4 1/2" 127 mm x 114.30 mm	70912	3	\$94.50	3	24	43		
	70913	4	\$94.50					
	61862	10	\$94.50				✓	
	61874	10A	\$94.50					
	61873	10B	\$101.50				✓	
	61866	26D	\$94.50					
	61903	32	\$94.50					
	61868	32D	\$86.50				✓	
	<i>Hospital Tip</i>	61868H	32D-HT				\$102.50	✓
	5" x 4 1/2" (NRP) 127 mm x 114.30 mm	61863	10-NRP				\$98.50	3
61861		10B-NRP	\$105.50	✓				
61869		26D-NRP	\$98.50					
61871		32D-NRP	\$90.50	✓				
5" x 5" 127 mm x 127 mm	61933	3	\$108.50	3	24	47		
	61929	4	\$108.50					
	61935	10	\$108.50					
	61930	10B	\$115.50					
	61943	26D	\$108.50					
	61928	32D	\$100.50				✓	
	61946	32D-NRP	\$104.50				✓	

T4B3386
Price Code 50

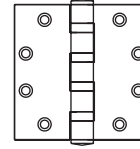

Size	Part Number	Finish	Price Each	Box Qty.	Case Qty.	Case Wgt.	Q S
4 1/2" x 4 1/2" (NRP) 114.30 mm x 114.30 mm	61849	32D-NRP	\$104.00	3	18	43	✓
	68828	10B	\$218.50	3	18	43	
	68839	26D	\$211.50				
68824	32D	\$203.50					
6" x 5" 152.4 mm x 127 mm	68822	32D-NRP	\$207.50	3	18	43	✓
	64607	10B	\$225.50	3	18	74	
64604	32D	\$210.50					

T6B3386
Price Code 50

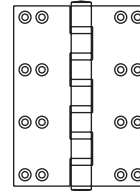

Size	Part Number	Finish	Price Each	Box Qty.	Case Qty.	Case Wgt.	Q S
8" x 8" 203.2 mm x 203.2 mm	69060	32D	\$305.00	3	12	66	

TCA3386
Price Code 50

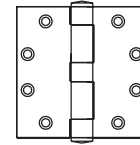

Size	Part Number	Finish	Price Each	Box Qty.	Case Qty.	Case Wgt.	Q S
4 1/2" x 4 1/2" 114.30 mm x 114.30 mm	68138	3	\$143.00	3	24	37	
	68141	10B	\$150.00				
	68142	26	\$143.00				
	68132	26D	\$143.00				
	68133	32D	\$135.00				✓
5" x 4 1/2" 127 mm x 114.30 mm	68158	3	\$169.50	3	24	43	
	68154	4	\$169.50				
	68161	10B	\$176.50				
	68153	32D	\$161.50				✓
	5" x 5" 127 mm x 127 mm Wide throw not available in TCA Series	68168	32D				\$175.50

McKinney
ASSA ABLOY

Experience a safer
and more open world

800 346 7707 | www.mckinneyhinge.com
USA Prices Effective March 1, 2024

Non-Ferrous Heavy Weight 5 Knuckle Bearing

T4A3386 Price Code 50

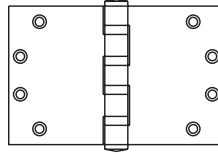

Size	Part Number	Finish	Price Each	Box Qty.	Case Qty.	Case Wgt.	Q	S
4 1/2" x 5" 114.30 mm x 127 mm	70977	10B	\$185.00	3	24	60		
	70970	26D	\$178.00					
	70990	32D	\$170.00					
4 1/2" x 6" 114.30 mm x 152.4 mm	71058	10B	\$195.00	3	24	60		
	71050	26D	\$188.00					
	71051	32D	\$180.00					
4 1/2" x 7" 114.30 mm x 177.8 mm	71011	10B	\$213.50	3	24	60		
	71016	32D	\$198.50					
4 1/2" x 8" 114.30 mm x 203.2 mm	71086	32D	\$216.50	3	24	60		

Size	Part Number	Finish	Price Each	Box Qty.	Case Qty.	Case Wgt.	Q	S
5" x 6" 127 mm x 152.4 mm	71067	10B	\$255.50	3	24	70		
	70892	26D	\$248.50					
	70893	32D	\$240.50					
5" x 7" 127 mm x 177.8 mm	70908	10B	\$265.50	3	24	70		
	70900	26D	\$258.50					
	70901	32D	\$250.50					
5" x 8" 127 mm x 203.2 mm	70958	10B	\$275.50	3	24	70		
	70950	26D	\$268.50					
	70951	32D	\$260.50					

Heavy Weight Stainless Steel Swing Clear

T4A3395 Price Code 50, Hinges are NRP

Size	Part Number	Finish	Price Each	Box Qty.	Case Qty.	Case Wgt.	Q	S
4 1/2" 114.30 mm	55195	32D	\$169.00	3	24	59	✓	
5" 127 mm	55196	32D	\$187.50	3	24	59	✓	

T4A4395 Price Code 50, Hinges are NRP

Size	Part Number	Finish	Price Each	Box Qty.	Case Qty.	Case Wgt.	Q	S
4 1/2" 114.30 mm	73441	32D	\$193.00	3	24	59	✓	

Steel Heavy Weight 2 Knuckle Bearing

TA3750

Price Code 20

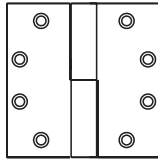

Part Number	Finish	Price Each	Hand	Box Qty.	Case Qty.	Case Wgt.	Q	S
4 1/2" x 4 1/2" 114.30 mm x 114.30 mm								
66513	3	\$73.00	R.H.	3	24	37		
66514	3	\$73.00	L.H.					
66516	4	\$73.00	L.H.					
66505	10	\$73.00	R.H.					
66506	10	\$73.00	L.H.					
66532	10B	\$80.00	R.H.					
66531	10B	\$80.00	L.H.					
66511	26	\$73.00	R.H.					
66517	26D	\$65.00	R.H.					
66518	26D	\$65.00	L.H.					

Part Number	Finish	Price Each	Hand	Box Qty.	Case Qty.	Case Wgt.	Q	S
5" x 4 1/2" 127 mm x 114.30 mm								
66561	3	\$89.50	R.H.	3	24	39		
66562	3	\$89.50	L.H.					
66563	4	\$89.50	R.H.					
66564	4	\$89.50	L.H.					
66547	10	\$89.50	R.H.					
66548	10	\$89.50	L.H.					
66581	10B	\$96.50	R.H.					
66582	10B	\$96.50	L.H.					
66553	26	\$89.50	R.H.					
66554	26	\$89.50	L.H.					
66559	26D	\$81.50	R.H.					
66560	26D	\$81.50	L.H.					

Steel Heavy Weight 5 Knuckle Bearing

T4A3786

Price Code 50

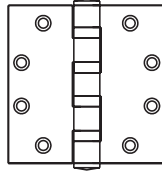

Size	Part Number	Finish	Price Each	Box Qty.	Case Qty.	Case Wgt.	Q S				
4 1/2" x 4" 114.30 mm x 101.60 mm	58331	26D	\$26.00	3	24	35	✓				
	58334	10B	\$41.00				✓				
4 1/2" x 4" (NRP) 114.30 mm x 101.60 mm	58327	4-NRP	\$37.00	3	24	35	✓				
	58337	26D-NRP	\$30.00				✓				
4 1/2" x 4 1/2" 114.30 mm x 114.30 mm	58375	P	\$34.00	3	24	35	✓				
	58343	3	\$34.00				✓				
	58344	4	\$34.00				✓				
	58348	5	\$34.00				✓				
	58379	10	\$34.00				✓				
	58367	10A	\$34.00				✓				
	58346	10B	\$41.00				✓				
	58346E	10BE	\$34.00				✓				
	58373	15	\$34.00				✓				
	58377	26	\$34.00				✓				
	58384	26D	\$26.00				✓				
	58341	D4	\$34.00				✓				
	56501	BSP	\$41.00				✓				
	56521	WSP	\$41.00				✓				
	4 1/2" x 4 1/2" (NRP) 114.30 mm x 114.30 mm	58338	3-NRP				\$38.00	3	24	35	✓
		58387	P-NRP				\$38.00				✓
58386		10-NRP	\$38.00	✓							
58388		26D-NRP	\$30.00	✓							
58385		10B-NRP	\$45.00	✓							
5" x 4" 127 mm x 101.60 mm	58347E	10BE-NRP	\$38.00	3	24	35	✓				
	58435	26D	\$38.50				✓				
5" x 4 1/2" 127 mm x 114.30 mm	58440	P	\$50.50	3	24	41	✓				
	58444	3	\$50.50				✓				
	58446	4	\$50.50				✓				
	58445	10	\$50.50				✓				
	58453	10A	\$50.50				✓				
	58464	10B	\$57.50				✓				
	58464E	10BE	\$50.50				✓				
	72815	15	\$50.50				✓				
	58467	26	\$50.50				✓				
	58443	26D	\$42.50				✓				
	56511	BSP	\$57.50				✓				
	5" x 4 1/2" (NRP) 127 mm x 114.30 mm	58442	P-NRP				\$54.50	3	24	41	✓
58449		26D-NRP	\$46.50	✓							
5" x 5" 127 mm x 127 mm	58530	3	\$55.50	3	24	55	✓				
	58527	4	\$55.50				✓				
	58524	10	\$55.50				✓				
	58532	10B	\$62.50				✓				
	58533	15	\$55.50				✓				
	58538	26	\$55.50				✓				
	58522	26D	\$47.50				✓				
	58543	26D-NRP	\$51.50				✓				

T4B3786 Price Code 50

6" x 5" 152.4 mm x 127 mm	72783	P	\$182.00	3	18	42	
	72788	3	\$182.00				
	72792	10B	\$189.00				
	72796	26D	\$175.00				
6" x 6" 152.4 mm x 152.4 mm	58622	3	\$187.00	3	18	62	
	58611	26D	\$180.00				

Steel Heavy Weight Wide Throw 5 Knuckle Bearing

T4A3786

Price Code 50

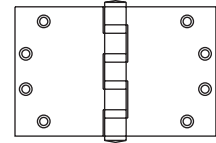

Size	Part Number	Finish	Price Each	Box Qty.	Case Qty.	Case Wgt.	Q S
4 1/2" x 5" 114.30 mm x 127 mm	72705	10	\$148.00	3	24	55	
	72707	10B	\$155.00				
	72700	26D	\$140.00				
4 1/2" x 6" 114.30 mm x 152.4 mm	72731	3	\$148.00	3	24	55	
	72733	10	\$148.00				
	72735	10B	\$155.00				
	72728	26D	\$140.00				
4 1/2" x 7" 114.30 mm x 177.8 mm	72761	10B	\$155.00	3	24	55	
	72754	26D	\$140.00				
4 1/2" x 8" 114.30 mm x 203.2 mm	72807	10B	\$167.50	3	24	55	
	72800	26D	\$152.50				
5" x 6" 127 mm x 152.4 mm	72859	3	\$160.50	3	24	64	
	72854	10	\$160.50				
	72855	10B	\$167.50				
	72857	26D	\$152.50				
5" x 7" 127 mm x 177.8 mm	72905	10B	\$171.50	3	24	64	
	72907	26D	\$156.50				
5" x 8" 127 mm x 203.2 mm	72955	10B	\$176.50	3	24	64	
	72957	26D	\$161.50				

Steel Heavy Weight 5 Knuckle Concealed Bearing

TCA3786

Price Code 50

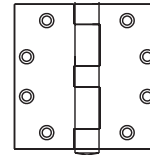

Size	Part Number	Finish	Price Each	Box Qty.	Case Qty.	Case Wgt.	Q S
4 1/2" x 4 1/2" 114.30 mm x 114.30 mm	67328	3	\$73.00	3	24	35	
	67322	4	\$73.00				
	67323	10	\$73.00				
	67324	10B	\$80.00				
	67326	26D	\$65.00				✓
	67319	26D-NRP	\$69.00				✓
5" x 4" 127 mm x 101.60 mm	67335	26D	\$77.50				✓
5" x 4 1/2" 127 mm x 114.30 mm	67348	3	\$89.50	3	24	41	
	67343	10	\$89.50				
	67344	10B	\$96.50				
	67351	26	\$89.50				
	67346	26D	\$81.50				✓

McKinney
ASSA ABLOY

Experience a safer
and more open world

Steel Heavy Weight 6-Bearing

T6B3786

Price Code 50

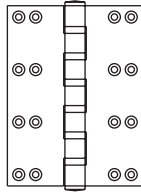

Size	Part Number	Finish	Price Each	Box Qty.	Case Qty.	Case Wgt.	Q S
8" x 6" 203.2 mm x 152.4 mm	58642	26D	\$250.00	3	12	49	

HT4A3786 – Hospital Tip Price Code 50

4 1/2" x 4 1/2" 114.30 mm x 114.30 mm	58396	26D	\$42.00	3	12	49	✓
5" x 4 1/2" 127 mm x 114.30 mm	58462	26D	\$58.50	3	12	49	✓

T4A4786 26D – Beveled Edge Price Code 50

4 1/2" x 4 1/2" 114.30 mm x 114.30 mm	58384BV	26D	\$50.00	3	24	35	
--	---------	-----	---------	---	----	----	--

Steel Heavy Weight Swing Clear 5 Knuckle Bearing

T4A3795 Price Code 50

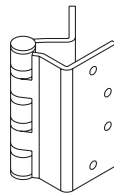

Size	Part Number	Finish	Price Each	Box Qty.	Case Qty.	Case Wgt.	Q S
4 1/2" 114.30 mm	73462	10	\$103.00	3	24	47	✓
	73466	10B	\$110.00				
	73463	26D	\$95.00				
	73454	HT-26D	\$111.00				
5" 127 mm	73475	4	\$115.50	3	24	47	✓
	73478	10B	\$122.50				
	73482	26D	\$107.50				
	73486	HT-26D	\$123.50				

Hinges are NRP, reversible and non-handed.

Steel Swing Clear Heavy Weight Beveled Edge Bearing

T4A4795 Price Code 50

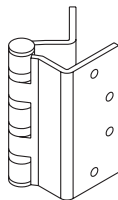

Size	Part Number	Finish	Price Each	Box Qty.	Case Qty.	Case Wgt.	Q S
4 1/2" 114.30 mm	73445	4	\$127.00	3	24	57	✓
	73446	10	\$127.00				
	73448	10B	\$134.00				
	73451	26D	\$119.00				
	73452	HT-26D	\$135.00				
5" 127 mm	73596	10	\$139.50	3	24	57	✓
	73597	10A	\$139.50				
	73598	10B	\$146.50				
	73590	26D	\$131.50				
	73589	HT-26D	\$147.50				

Hinges are NRP, reversible and non-handed.

MacPro® Hinges Steel Standard Weight 5 Knuckle

MP79 Price Code 57

Size	Part Number	Finish	Price Each	Box Qty.	Case Qty.	Case Wgt.	Q S
4 1/2" x 4" 114.30 mm x 101.60 mm	76334	P	\$3.00	3	48	50	✓
	76387	15	\$5.50				
	76326	26	\$5.50				
	76330	26D	\$3.00				
4 1/2" x 4" 114.30 mm x 101.60 mm	76331	26D NRP	\$3.85	3	48	50	✓
	76330	26D	\$3.00				
4 1/2" x 4 1/2" 114.30 mm x 114.30 mm	76368	P	\$3.00	3	48	54	✓
	76344	3	\$5.50				
	76356	10B	\$5.50				
	76364E	10BE	\$5.50				
	76384	15	\$5.50				
	76360	26	\$5.50				
	76364	26D	\$3.00				
	76369	P NRP	\$3.85				
	76345	3 NRP	\$6.35				
	76349	4 NRP	\$6.35				
4 1/2" x 4 1/2" 114.30 mm x 114.30 mm	76357	10B NRP	\$6.35	3	48	54	✓
	76357E	10BE NRP	\$6.35				
	76365	26D NRP	\$3.85				
	76365	26D NRP	\$3.85				

MacPro® Hinge Pin Stop

Price Code 57

For 4 1/2" Size: MP79 & MPB79

Part No.	Description	Finish	Price Each	Box Qty.	Case Qty.	Case Wgt.	Q S
76305	MacPro® Hinge Pin Stop	26D	\$5.00	6	96		✓
76307	MacPro® Hinge Pin Stop	BSP	\$7.50				

McKinney®

ASSA ABLOY

Experience a safer
and more open world

FM-13

MacPro® Steel Standard Weight 5 Knuckle Bearing

MPB79

Add \$0.85 for NRP where not shown on standard weight MacPro Hinges.

Price Code 57

Size	Part Number	Finish	Price Each	Box Qty.	Case Qty.	Case Wgt.	Q S
4½" x 4" 114.30 mm x 101.60 mm	76354E	10BE	\$5.90	3	48	51	✓
	76386	15	\$5.90				✓
	76362	26D	\$3.40				✓
	56516	BSP	\$5.90				✓
	76367	P NRP	\$4.25				✓
4½" x 4" 114.30 mm x 101.60 mm (NRP)	76355	10B NRP	\$6.75	3	48	51	✓
	76363	26D NRP	\$4.25				✓

Size	Part Number	Finish	Price Each	Box Qty.	Case Qty.	Case Wgt.	Q S
4½" x 4½" 114.30 mm x 114.30 mm	76336	P	\$3.40	3	48	55	✓
	76312	3	\$5.90				✓
	76316	4	\$5.90				✓
	76324	10B	\$5.90				✓
	76324E	10BE	\$5.90				✓
	76383	15	\$5.90				✓
	76328	26	\$5.90				✓
	76332	26D	\$3.40				✓
	56504	BSP	\$5.90				✓
	4½" x 4½" 114.30 mm x 114.30 mm (NRP)	76337	P NRP				\$4.25
76313		3 NRP	\$6.75	✓			
76317		4 NRP	\$6.75	✓			
76325		10B NRP	\$6.75	✓			
76325E		10BE NRP	\$6.75	✓			
76329		26 NRP	\$6.75	✓			
76333		26D NRP	\$4.25	✓			
76396		15 NRP	\$6.75	✓			

MacPro® Steel Heavy Weight 5 Knuckle Bearing

MPB68

Price Code 57 Add \$0.85 for NRP if not shown

Size	Part Number	Finish	Price Each	Box Qty.	Case Qty.	Case Wgt.	Q S
4½" x 4½" 114.30 mm x 114.30 mm	76374	26D	\$10.00	3	24	35	✓
	76374E	10BE	\$12.50				✓
	76375	26D NRP	\$10.85				✓
	76395	15	\$12.50				✓
	56505	BSP	\$12.50				✓
5" x 4½" 127 mm x 114.30 mm	76390	26D	\$14.00	3	24	39	✓
	76390E	10BE	\$16.50				✓
	76391	26D NRP	\$14.85				✓
	76397	15	\$16.50				✓

MacPro® Non-Ferrous Heavy Weight 5 Knuckle Bearing

MPB99

Price Code 57

Size	Part Number	Finish	Price Each	Box Qty.	Case Qty.	Case Wgt.	Q S
4½" x 4½" 114.30 mm x 114.30 mm	76376	32D	\$15.50	3	24	37	✓
	76377	32D NRP	\$16.35				✓
5" x 4½" 127 mm x 114.30 mm	76392	32D	\$19.50	3	24	41	✓
	76393	32D NRP	\$20.35				✓

MacPro® Non-Ferrous Standard Weight 5 Knuckle Bearing

MP91 Price Code 57

Size	Part Number	Finish	Price Each	Box Qty.	Case Qty.	Case Wgt.	Q S
4½" x 4½" 114.30 mm x 114.30 mm (NRP)	76373	32D NRP	\$9.75	3	48	33	

MPB91 Price Code 57

Size	Part Number	Finish	Price Each	Box Qty.	Case Qty.	Case Wgt.	Q S
4½" x 4" 114.30 mm x 101.60 mm	76371	32D NRP	\$9.75	3	48	33	✓
4½" x 4½" 114.30 mm x 114.30 mm	76340	32D	\$8.90	3	48	33	✓
4½" x 4½" 114.30 mm x 114.30 mm (NRP)	76341	32D NRP	\$9.75	3	48	33	✓



Experience a safer and more open world

800 346 7707 | www.mckinneyhinge.com
USA Prices Effective March 1, 2024 – Rev. 4/17/24

Copyright © 2024, ASSA ABLOY Accessories and Door Controls Group, Inc. All rights reserved. Reproduction in whole or in part without the express written permission of ASSA ABLOY Accessories and Door Controls Group, Inc. is prohibited.

Electric Hinges CC-4

Electric hinge prices are for the part #'s shown in this section only. If the hinge you require is not an exact match use the base part number price for the hinge and add the Electrical Option price from page GEN-5. If TB or T4B option is required see page GEN-6 for pricing addition.

TA2314 - CC4 Price Code 59

Size	Part Number	Finish	Price Each	Box Qty.	Q S
4½" x 4" 114.30 mm x 101.60 mm	71218	3	\$190.50	1	
	71221	26	\$190.50		
	71222	26D	\$182.50		
	71179	32D	\$182.50		
4½" x 4½" 114.30 mm x 114.30 mm	71139	10B	\$201.50	1	
	71142	26D	\$186.50		
	56183	32D	\$186.50		

T4A3386 - CC4 Price Code 59

Size	Part Number	Finish	Price Each	Box Qty.	Q S
4½" x 4½" 114.30 mm x 114.30 mm	71260	3	\$219.50	1	
	71261	4	\$219.50		
	71106	26D	\$219.50		
	71167	32D	\$211.50		
5" x 4½" 127 mm x 114.30 mm	71210	32D	\$238.00	1	

TA2714 - CC4 Price Code 59

Size	Part Number	Finish	Price Each	Box Qty.	Q S
4½" x 4" 114.30 mm x 101.60 mm	55664	P	\$160.75	1	
	73801	15	\$168.75		
	55669	26D	\$160.75		✓
	71230	D3	\$168.75		
4½" x 4½" 114.30 mm x 114.30 mm	71128	3	\$168.75	1	
	55902	4	\$168.75		
	71110	10	\$168.75		
	55886	10B	\$175.75		
	73960	15	\$168.75		
	55887	26	\$168.75		
5" x 4½" 127 mm x 114.30 mm	55885	26D	\$160.75	1	✓
	71123	10	\$180.25		
	71124	26D	\$172.25		

T4A3786 - CC4 Price Code 59

Size	Part Number	Finish	Price Each	Box Qty.	Q S
4½" x 4½" 114.30 mm x 114.30 mm	71273	10A	\$185.50	1	
	71274	10B	\$192.50		
	71118	26D	\$177.50		✓

T4A3786 - CC4 Price Code 59

Size	Part Number	Finish	Price Each	Box Qty.	Q S
5" x 4½" 127 mm x 114.30 mm	71280	P	\$202.00	1	
	71136	26D	\$194.00		✓
	71281	4	\$202.00		

Swing Clear Hinges

T4A4795 - CC4

Price Code 59

Size	Part Number	Finish	Price Each	Box Qty.	Q S
4½" 114.30 mm	T4A4795 73671	26D	\$288.50	1	

Electric Hinges CC-8

Electric hinge prices are for the part #'s shown in this section only. If the hinge you require is not an exact match use the base part number price for the hinge and add the Electrical Option price from page GEN-5. If TB or T4B option is required see page GEN-6 for pricing addition.

TA2314 - CC8 Price Code 59

Size	Part Number	Finish	Price Each	Box Qty.	Q S
4½" x 4" 114.30 mm x 101.60 mm	71450	3	\$285.50	1	
	71516	15	\$285.50		
	71165	32D	\$277.50		✓
4½" x 4½" 114.30 mm x 114.30 mm	71458	10B	\$296.50	1	✓
	56184	26D	\$281.50		✓
	71161	32D	\$281.50		✓

T4A3386 - CC8 Price Code 59

Size	Part Number	Finish	Price Each	Box Qty.	Q S
4½" x 4½" 114.30 mm x 114.30 mm	71485	3	\$314.50	1	
	71487	10B	\$321.50		✓
	71518	15	\$314.50		
	71488	26	\$314.50		
	71168	26D	\$314.50		✓
	71169	32D	\$306.50		✓
5" x 4½" 127 mm x 114.30 mm	71490	26D	\$341.00	1	
	71212	32D	\$333.00		

TA2714 - CC8 Price Code 59

Size	Part Number	Finish	Price Each	Box Qty.	Q S
4½" x 4" 114.30 mm x 101.60 mm	71461	P	\$255.75	1	
	71463	3	\$263.75		
	71467	10B	\$270.75		
	73802	15	\$263.75		
	71469	26D	\$255.75		✓
	71471	D3	\$263.75		
4½" x 4½" 114.30 mm x 114.30 mm	71475	3	\$263.75	1	✓
	71476	4	\$263.75		✓
	71477	10	\$263.75		✓
	71479	10B	\$270.75		✓
	71479E	10BE	\$263.75		✓
	71520	15	\$263.75		✓
	55905	26	\$263.75		
	55904	26D	\$255.75		✓
	56527	BSP	\$270.75		✓
	71482	D3	\$263.75		
5" x 4½" 127 mm x 114.30 mm	69082	26D	\$267.25	1	✓

T4A3786 - CC8 Price Code 59

Size	Part Number	Finish	Price Each	Box Qty.	Q S
4½" x 4" 114.30 mm x 101.60 mm	73995	26D	\$272.50	1	✓
4½" x 4½" 114.30 mm x 114.30 mm	71492	P	\$280.50	1	
	71494	3	\$280.50		✓
	71496	10	\$280.50		✓
	71497	10A	\$280.50		
	71498	10B	\$287.50		✓
	71166E	10BE	\$280.50		✓
	71522	15	\$280.50		✓
	71499	26	\$280.50		✓
	71166	26D	\$272.50		✓
	56508	BSP	\$287.50		✓
5" x 4½" 127 mm x 114.30 mm	71508	26D	\$289.00	1	✓

HTA2714 - CC8 Price Code 59

Size	Part Number	Finish	Price Each	Box Qty.	Q S
4½" x 4½" 114.30 mm x 114.30 mm	71521	26D	\$271.75	1	✓

HT4A3786 - CC8 Price Code 59

Size	Part Number	Finish	Price Each	Box Qty.	Q S
5" x 4½" 127 mm x 114.30 mm	73412	26D	\$305.00	1	

Swing Clear Hinges

TA2895 - CC8

Price Code 59

Size	Part Number	Finish	Price Each	Box Qty.	Q S
4½" 114.30 mm	TA2895 73652	26D	\$340.75	1	

T4A3795 - CC8

Price Code 59

Size	Part Number	Finish	Price Each	Box Qty.	Q S
5" 127 mm	T4A3795 73680	26D	\$372.00	1	



Experience a safer
and more open world

800 346 7707 | www.mckinneyhinge.com
USA Prices Effective March 1, 2024

Copyright © 2024, ASSA ABLOY Accessories and Door Controls Group, Inc. All rights reserved. Reproduction in whole or in part without the express written permission of ASSA ABLOY Accessories and Door Controls Group, Inc. is prohibited.

Electric Hinges QC-4

Electric hinge prices are for the part #'s shown in this section only. If the hinge you require is not an exact match use the base part number price for the hinge and add the Electrical Option price from page GEN-5. If TB or T4B option is required see page GEN-6 for pricing addition.

TA2314 - QC4 Price Code 59

Size	Part Number	Finish	Price Each	Box Qty.	Q S
4½" x 4" 114.30 mm x 101.60 mm	73160	3	\$205.50	1	
	73161	4	\$205.50		
	73163	26	\$205.50		
	73165	32D	\$197.50		
4½" x 4½" 114.30 mm x 114.30 mm	73166	3	\$209.50	1	
	73168	10B	\$216.50		
	73170	26D	\$201.50		
	73171	32D	\$201.50		

T4A3386 - QC4 Price Code 59

Size	Part Number	Finish	Price Each	Box Qty.	Q S
4½" x 4½" 114.30 mm x 114.30 mm	73200	3	\$234.50	1	
	73201	4	\$234.50		
	73202	10B	\$241.50		
	73204	26D	\$234.50		
	73205	32D	\$226.50		
5" x 4½" 127 mm x 114.30 mm	73207	32D	\$253.00	1	

TA2714 - QC4 Price Code 59

Size	Part Number	Finish	Price Each	Box Qty.	Q S
4½" x 4" 114.30 mm x 101.60 mm	73172	P	\$175.75	1	
	73176	10	\$183.75		
	73177	10A	\$183.75		
	73178	10B	\$190.75		
	73180	26D	\$175.75		
	73182	D3	\$183.75		
4½" x 4½" 114.30 mm x 114.30 mm	73187	4	\$183.75	1	
	73188	10	\$183.75		
	73189	10A	\$183.75		
	73190	10B	\$190.75		
	73191	26	\$183.75		
	73192	26D	\$175.75		
	73194	D3	\$183.75		

T4A3786 - QC4 Price Code 59

Size	Part Number	Finish	Price Each	Box Qty.	Q S
4½" x 4½" 114.30 mm x 114.30 mm	73213	10A	\$200.50	1	
	73214	10B	\$207.50		
	73216	26D	\$192.50		
5" x 4½" 127 mm x 114.30 mm	73221	26D	\$209.00	1	✓

Swing Clear Hinges

T4A3795 - QC4

Price Code 59

Size	Part Number	Finish	Price Each	Box Qty.	Q S
4½" 114.30 mm	T4A3795 73668	26D	\$279.50	1	

Electric Hinges QC-8

Electric hinge prices are for the part #'s shown in this section only. If the hinge you require is not an exact match use the base part number price for the hinge and add the Electrical Option price from page GEN-5. If TB or T4B option is required see page GEN-6 for pricing addition.

TA2314 - QC8 Price Code 59

Size	Part Number	Finish	Price Each	Box Qty.	Q S
4½" x 4" 114.30 mm x 101.60 mm	73280	3	\$301.50	1	
	73283	26	\$301.50		
	73284	26D	\$293.50		
	73285	32D	\$293.50		
4½" x 4½" 114.30 mm x 114.30 mm	73288	10B	\$312.50	1	
	73290	26D	\$297.50		
	73291	32D	\$297.50		

T4A3386 - QC8 Price Code 59

Size	Part Number	Finish	Price Each	Box Qty.	Q S
4½" x 4½" 114.30 mm x 114.30 mm	73316	3	\$330.50	1	
	73317	4	\$330.50		
	73318	10B	\$337.50		
	73320	26D	\$330.50		
	73321	32D	\$322.50		
5" x 4½" 127 mm x 114.30 mm	73322	26D	\$357.00	1	
	73323	32D	\$349.00		

TA2714 - QC8 Price Code 59

Size	Part Number	Finish	Price Each	Box Qty.	Q S
4½" x 4" 114.30 mm x 101.60 mm	73292	P	\$271.75	1	
	73297	10A	\$279.75		
	73298	10B	\$286.75		
	73804	15	\$279.75		
	73300	26D	\$271.75		
	73302	D3	\$279.75		
4½" x 4½" 114.30 mm x 114.30 mm	73306	3	\$279.75	1	
	73307	4	\$279.75		
	73308	10	\$279.75		
	73309	10A	\$279.75		
	73310	10B	\$286.75		
	73311	26	\$279.75		
	73312	26D	\$271.75		

T4A3786 - QC8 Price Code 59

Size	Part Number	Finish	Price Each	Box Qty.	Q S		
4½" x 4½" 114.30 mm x 114.30 mm	73324	P	\$296.50	1			
	73326	3	\$296.50				
	73327	4	\$296.50				
	73328	10	\$296.50				
	73329	10A	\$296.50				
	73330	10B	\$303.50				
	73331	26	\$296.50				
	73332	26D	\$288.50				
	5" x 4½" 127 mm x 114.30 mm	73336	26D		\$305.00	1	
		73961	10B		\$320.00		

Swing Clear Hinges

TA2895, T4A3795, T4A4795 - QC8 Price Code 59

Size	Part Number	Finish	Price Each	Box Qty.	Q S	
4½" 114.30 mm	TA2895	73656	26D	\$356.75	1	
	T4A3795	73670	26D	\$375.50		
	T4A4795	73677	26D	\$399.50		

T4A3795, T4A4795 - QC8 Price Code 59

Size	Part Number	Finish	Price Each	Box Qty.	Q S	
5" 127 mm	T4A3795	73684	26D	\$388.00	1	
	T4A4795	73691	26D	\$412.00		



Experience a safer
and more open world

800 346 7707 | www.mckinneyhinge.com
USA Prices Effective March 1, 2024

Electric Hinges QC-12

Electric hinge prices are for the part #'s shown in this section only. If the hinge you require is not an exact match use the base part number price for the hinge and add the Electrical Option price from page GEN-5. If TB or T4B option is required see page GEN-6 for pricing addition.

TA2314 - QC12 Price Code 59

Size	Part Number	Finish	Price Each	Box Qty.	Q S
4½" x 4" 114.30 mm x 101.60 mm	73338	3	\$387.50	1	
	73339	4	\$387.50		
	73341	26	\$387.50		
	73342	26D	\$379.50		
	73343	32D	\$379.50		
4½" x 4½" 114.30 mm x 114.30 mm	73346	10B	\$398.50	1	✓
	73348	26D	\$383.50		✓
	73349	32D	\$383.50		✓

TA2714 - QC12 Price Code 59

Size	Part Number	Finish	Price Each	Box Qty.	Q S
4½" x 4" 114.30 mm x 101.60 mm	73350	P	\$357.75	1	
	73353	4	\$365.75		
	73355	10A	\$365.75		
	73356	10B	\$372.75		
	73358	26D	\$357.75		✓
	73360	D3	\$365.75		
4½" x 4½" 114.30 mm x 114.30 mm	73362	P	\$357.75	1	
	73364	3	\$365.75		✓
	73365	4	\$365.75		✓
	73366	10	\$365.75		✓
	73368	10B	\$372.75		✓
	73368E	10BE	\$365.75		✓
	73369	26	\$365.75		✓
	73370	26D	\$357.75		✓
5" x 4½" 127 mm x 114.30 mm	56528	BSP	\$372.75	1	✓
	73373	D4	\$365.75		✓
	74027	26D	\$369.25		✓

T4A3386 - QC12 Price Code 59

Size	Part Number	Finish	Price Each	Box Qty.	Q S
4½" x 4" 114.30 mm x 101.60 mm	73998	26D	\$416.50	1	✓
	73375	4	\$416.50	1	
4½" x 4½" 114.30 mm x 114.30 mm	73376	10B	\$423.50		
	73378	26D	\$416.50		✓
	73379	32D	\$408.50		✓
5" x 4½" 127 mm x 114.30 mm	73393	15	\$443.00	1	
	73380	26D	\$443.00		
	73381	32D	\$435.00		

T4A3786 - QC12 Price Code 59

Size	Part Number	Finish	Price Each	Box Qty.	Q S
4½" x 4" 114.30 mm x 101.60 mm	73996	26D	\$374.50	1	✓
	4½" x 4½" 114.30 mm x 114.30 mm	73382	P	\$382.50	1
73384		3	\$382.50		
73385		4	\$382.50		
73386		10	\$382.50		
73387		10A	\$382.50		
73388		10B	\$389.50		
73390E		10BE	\$382.50	✓	
73389		26	\$382.50		
73390		26D	\$374.50	✓	
56509		BSP	\$389.50	✓	
5" x 4½" 127 mm x 114.30 mm	73395	P	\$399.00	1	
	73394	26D	\$391.00		✓
	56513	BSP	\$406.00		✓

HT4A3786 - QC12 Price Code 59

Size	Part Number	Finish	Price Each	Box Qty.	Q S
4½" x 4½" 114.30 mm x 114.30 mm	71526	26D	\$390.50	1	✓
	5" x 4½" 127 mm x 114.30 mm	73413	26D	\$407.00	1

HTA2714 - QC12 Price Code 59

Size	Part Number	Finish	Price Each	Box Qty.	Q S
4½" x 4½" 114.30 mm x 114.30 mm	71525	26D	\$373.75	1	✓

Three Knuckle Electric Hinges

Electric hinge prices are for the part #'s shown in this section only. If the hinge you require is not an exact match use the base part number price for the hinge and add the Electrical Option price from page GEN-5. If TB or T4B option is required see page GEN-6 for pricing addition.

TA314 Price Code 39

Size	Part Number	Finish	Option	Price Each	Box Qty.	Q S
4½" x 4" 114.30 mm x 101.60 mm	73731	26D	QC4	\$204.50	1	
	73813	32D	CC8	\$284.50		✓
	73812	32D	QC12	\$386.50		✓
	69467	26D	CC8	\$284.50		
4½" x 4½" 114.30 mm x 114.30 mm	73396	26D	QC8	\$304.50	1	
	73399	26D	QC12	\$390.50		
	71510	32D	CC8	\$288.50		✓
	73734	32D	QC4	\$208.50		
	73735	32D	QC8	\$304.50		
	73733	32D	QC12	\$390.50		✓

TA386 Price Code 39

Size	Part Number	Finish	Option	Price Each	Box Qty.	Q S
4½" x 4" 114.30 mm x 101.60 mm	70285	26D	CC4	\$227.50	1	
	70298	32D	CC8	\$314.50		✓
	73810	32D	QC12	\$416.50		✓
4½" x 4½" 114.30 mm x 114.30 mm	69466	32D	CC8	\$314.50	1	✓
	73737	32D	QC8	\$330.50		
	73736	32D	QC12	\$416.50		✓
	73739	26D	QC8	\$338.50		
5" x 4½" 127 mm x 114.30 mm	71215	32D	CC4	\$248.00	1	
	71217	32D	CC8	\$343.00		✓
	73811	32D	QC12	\$445.00		✓
	73741	26D	QC8	\$367.00		

TA714 Price Code 39

Size	Part Number	Finish	Option	Price Each	Box Qty.	Q S		
4½" x 4" 114.30 mm x 101.60 mm	69203	26D	CC4	\$168.25	1	✓		
	69083	26D	CC8	\$263.25		✓		
	73978	26D	QC4	\$183.25				
	82101	26D	QC8	\$279.25				
	73994	26D	QC12	\$365.25		✓		
	73742	15	CC4	\$176.25				
	74010	15	CC8	\$271.25		✓		
	74012	15	QC12	\$373.25		✓		
	4½" x 4½" 114.30 mm x 114.30 mm	69266	26D	CC4		\$168.25	1	✓
		69084	26D	CC8		\$263.25		✓
73977		26D	QC4	\$183.25				
73398		26D	QC8	\$279.25				
73401		26D	QC12	\$365.25	✓			
69468		10	CC4	\$176.25				
74011		15	CC8	\$271.25	✓			
73407		P	QC4	\$183.25				
73400		P	QC12	\$365.25				
74013		15	QC12	\$373.25	✓			
5" x 4½" 127 mm x 114.30 mm	56512	BSP	QC12	\$380.25	1	✓		
	74021	26D	CC8	\$275.25		✓		
	74022	26D	QC12	\$377.25		✓		

TA786 Price Code 39

Size	Part Number	Finish	Option	Price Each	Box Qty.	Q S
4½" x 4" 114.30 mm x 101.60 mm	73999	26D	CC8	\$287.50	1	✓
	73747	26D	QC8	\$303.50		
	74000	26D	QC12	\$389.50		✓
4½" x 4½" 114.30 mm x 114.30 mm	75245	26D	CC4	\$192.50	1	
	69461	26D	CC8	\$287.50		
	73748	26D	QC4	\$207.50		
	73749	26D	QC8	\$303.50		✓
	73439	26D	QC12	\$389.50		✓
5" x 4½" 127 mm x 114.30 mm	74018	26D	CC8	\$305.00	1	✓
	74023	26D	QC12	\$407.00		✓



Experience a safer
and more open world

800 346 7707 | www.mckinneyhinge.com
USA Prices Effective March 1, 2024

Copyright © 2024, ASSA ABLOY Accessories and Door Controls Group, Inc. All rights reserved. Reproduction in whole or in part without the express written permission of ASSA ABLOY Accessories and Door Controls Group, Inc. is prohibited.

MacPro® Electric Hinges – Concealed Circuit (CC) Price Code 57

Size	Part Number	Finish	Price Each	Product	Box Qty.	QS
4½" x 4" 114.30 mm x 101.60 mm	76402	26D	\$65.80	MPB79-CC8	1	✓
	76420	32D	\$71.30	MPB91-CC8	1	✓
	76424	32D	\$77.90	MPB99-CC8	1	✓
4½" x 4½" 114.30 mm x 114.30 mm	56533	BSP	\$68.30	MPB79-CC8	1	✓
	76405	26D	\$60.80	MPB79-CC4	1	✓
	76407	26D	\$65.80	MPB79-CC8	1	✓
	76410	26D	\$67.40	MPB68-CC4	1	
	76412	26D	\$72.40	MPB68-CC8	1	✓
	76422	32D	\$71.30	MPB91-CC8	1	✓
	76426	32D	\$77.90	MPB99-CC8	1	✓
	5" x 4½" 127 mm x 114.30 mm	76428	32D	\$81.90	MPB99-CC8	1
76433		26D	\$76.40	MPB68-CC8	1	

MacPro® Electric Hinges - ElectroLynx® Quick Connect (QC) Price Code 57

Size	Part Number	Finish	Price Each	Product	Box Qty.	QS
4½" x 4" 114.30 mm x 101.60 mm	76401	26D	\$86.80	MPB79-QC4	1	
	76403	26D	\$96.80	MPB79-QC8	1	
	76404	26D	\$107.80	MPB79-QC12	1	✓
	76421	32D	\$113.30	MPB91-QC12	1	✓
	76425	32D	\$119.90	MPB99-QC12	1	✓
4½" x 4½" 114.30 mm x 114.30 mm	56534	BSP	\$116.90	MPB79-QC12	1	
	76406	26D	\$86.80	MPB79-QC4	1	✓
	76408	26D	\$96.80	MPB79-QC8	1	
	76430	BSP	\$105.90	MPB79-QC8	1	
	76409	26D	\$107.80	MPB79-QC12	1	✓
	76411	26D	\$67.40	MPB68-QC4	1	
	76413	26D	\$103.40	MPB68-QC8	1	
	76414	26D	\$114.40	MPB68-QC12	1	✓
	76432	32D	\$102.30	MPB91-QC8	1	
	76423	32D	\$113.30	MPB91-QC12	1	✓
	76431	32D	\$108.90	MPB99-QC8	1	
5" x 4½" 127 mm x 114.30 mm	76427	32D	\$119.90	MPB99-QC12	1	✓
	76429	32D	\$123.90	MPB99-QC12	1	✓
	76434	26D	\$118.40	MPB68-QC12	1	

McKinney Electrolynx® Power over Ethernet (PoE) Hinges

Consult the factory for additional items with PoE option.

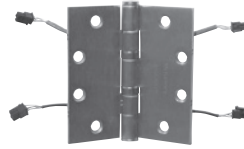

U.S. Patent No. 7,824,200

TA2314 Price Code 59

Size	Part Number	Finish	Price Each	Box Qty.	Q S
4½" x 4½" 114.30 mm x 114.30 mm	73710	32D POE	\$725.50	1	

TA2714 Price Code 59

Size	Part Number	Finish	Price Each	Box Qty.	Q S
4½" x 4" 114.30 mm x 101.60 mm	73712	26D POE	\$699.75	1	✓
4½" x 4½" 114.30 mm x 114.30 mm	73698	US3 POE	\$707.75	1	
	73700	US10 POE	\$707.75		
	73701	US10B POE	\$714.75		
	73695	26D POE	\$699.75		✓

T4A3386 Price Code 59

Size	Part Number	Finish	Price Each	Box Qty.	Q S
4½" x 4½" 114.30 mm x 114.30 mm	73711	32D POE	\$750.50	1	

T4A3786 Price Code 59

Size	Part Number	Finish	Price Each	Box Qty.	Q S
4½" x 4½" 114.30 mm x 114.30 mm	73715	D4 POE	\$724.50	1	
	73707	US10B POE	\$731.50		
	73708	US26 POE	\$724.50		
	73696	26D POE	\$716.50		✓
5" x 4½" 127 mm x 114.30 mm	71137	26D POE	\$733.00	1	✓

Magnetic Monitoring Hinges (MM)

TA2314 Price Code 59

Size	Part Number	Finish	Price Each	Box Qty.	Q S
4½" x 4½" 114.30 mm x 114.30 mm	71127	26D	\$375.50	1	

TA2714 Price Code 59

Size	Part Number	Finish	Price Each	Box Qty.	Q S
4½" x 4½" 114.30 mm x 114.30 mm	71171	P	\$349.75	1	
	71170	26D	\$349.75		

Concealed Electric Hinges

MK100ME Price Code 29

Size	Part Number	Finish	Price Each	Product	Box Qty.	Q S
6¼" x 1¼" 160 mm x 28 mm	MK67000CC12	26D	\$440.00	MK100-CC12	1	
	MK67000QC12	26D	\$465.00	MK100-QC12		
	MK67001CC12	Black	\$440.00	MK100-CC12		
	MK67001QC12	Black	\$465.00	MK100-QC12		



Experience a safer
and more open world

800 346 7707 | www.mckinneyhinge.com
USA Prices Effective March 1, 2024

Transfer Device Solutions

McKinney ElectroLynx® Harnesses & Components For Metal Doors

CORBIN RUSSWIN, SARGENT, and YALE Price Code 79

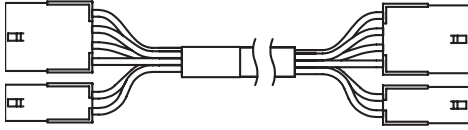

If metal door, order a retrofit cable with Molex connectors on both ends.

If the metal door is polystyrene filled or steel stiffened, the cable may need to be routed up and over the door.

McKinney Catalog #	Part #	Price	Description:	Max Hinge required (Not included)	QS
3", 6" & 12" Harness					
Between hinge and the end of an exit device					
QC-C003	93981	\$17.00	QC12 - 3" Wire Harness; 8 & 4 Pin Connector w/12 wires (For Exit Device Rail Jumper to Hinge)	QC12	✓
QC-C006	93982	\$19.00	QC12 - 6" Wire Harness; 8 & 4 Pin Connector w/12 wires (For Exit Device Rail Jumper to Hinge)	QC12	✓
QC-C012	93983	\$24.00	QC12 - 12" Wire Harness; 8 & 4 Pin Connector w/12 wires (For Exit Device Rail Jumper to Hinge)	QC12	✓
2', 3' & 4' Harness					
Between hinge and through the door to the lockset or exit device trim					
QC-C200	93984	\$26.00	QC12 - 26" Wire Harness; 8 & 4 Pin Connector w/12 Wires	QC12	✓
QC-C206	93985	\$27.00	QC12 - 32" Wire Harness; 8 & 4 Pin Connector w/12 Wires	QC12	✓
QC-C300	93986	\$28.00	QC12 - 38" Wire Harness; 8 & 4 Pin Connector w/12 wires	QC12	✓
QC-C306	93987	\$29.00	QC12 - 44" Wire Harness; 8 & 4 Pin Connector w/12 wires	QC12	✓
QC-C400	93988	\$30.00	QC12 - 50" Wire Harness; 8 & 4 Pin Connector w/12 wires	QC12	✓
15' Harness					
From the hinge location, up the jamb to the above the ceiling, or up and around a full lite or half lite metal door.					
QC-C1500	93989	\$63.00	QC12 - 15' 2" Wire Harness; 8 & 4 Pin Connector w/12 Wires	QC12	✓
	Custom Size*	POA	QC12 - Other custom sizes available. Consult factory. Harness; 8 & 4 Pin Connector w/12 Wires	QC12	✓

***Custom Length – Specify Length:**

- QC-C 60" to 80" Add \$5.00 to 93988 • QC-C 81" to 120" Add \$10.00 to 93988 • QC-C 10' to 15' Use Price of 93989
- QC-C 16' to 30' Add \$20.00 to 93989 • QC-C 31' to 60' Add \$40.00 to 93989 • QC-C 61' to 200' Add \$60.00 to 93989.

Transfer Device Solutions

McKINNEY ElectroLynx® Harnesses & Components For Wood Doors

CORBIN RUSSWIN, SARGENT, and YALE Price Code 79

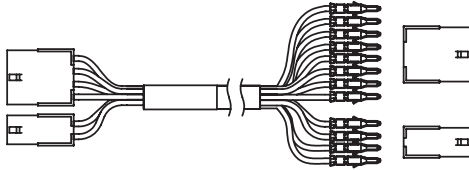

If wood door, order a retrofit cable with the Molex connector on one end, and pins crimped on the other end.

McKinney Catalog #	Part #	Price	Description:	Max Hinge Required (Not included)	QS
3", 6" & 12" Harness					
Between hinge and the end of an exit device					
QC-C003P	93990	\$23.00	QC12 - 3" Wire Harness; 8 & 4 Pin Connector w/12 wires (For Exit Device Rail Jumper to Hinge, Insert pre-pinned ends into plastic Molex connector)	QC12	✓
QC-C006P	93991	\$26.00	QC12 - 6" Wire Harness; 8 & 4 Pin Connector w/12 wires (For Exit Device Rail Jumper to Hinge, Insert pre-pinned ends into plastic Molex connector)	QC12	✓
QC-C012P	93992	\$30.00	QC12 - 12" Wire Harness; 8 & 4 Pin Connector w/12 wires (For Exit Device Rail Jumper to Hinge, Insert pre-pinned ends into plastic Molex connector)	QC12	✓
2', 3' & 4' Harness					
Between hinge and through the door to the lockset or exit device trim.					
QC-C200P	93993	\$31.00	QC12 - 26" Wire Harness; 8 & 4 Pin Connector w/12 wires (Insert pre-pinned ends into plastic Molex connector)	QC12	✓
QC-C206P	93994	\$32.00	QC12 - 32" Wire Harness; 8 & 4 Pin Connector w/12 wires (Insert pre-pinned ends into plastic Molex connector)	QC12	✓
QC-C300P	93995	\$33.00	QC12 - 38" Wire Harness; 8 & 4 Pin Connector w/12 wires (Insert pre-pinned ends into plastic Molex connector)	QC12	✓
QC-C306P	93996	\$35.00	QC12 - 44" Wire Harness; 8 & 4 Pin Connector w/12 wires (Insert pre-pinned ends into plastic Molex connector)	QC12	✓
QC-C400P	93997	\$36.00	QC12 - 50" Wire Harness; 8 & 4 Pin Connector w/12 wires (Insert pre-pinned ends into plastic Molex connector)	QC12	✓
15' Harness					
From the hinge location, up the jamb to the above the ceiling, or up and around a full lite or half lite metal door.					
QC-C1500P	93998	\$69.00	QC12 - 15' 2" Wire Harness; 8 & 4 Pin Connector w/12 Wires (Termination in Field)	QC12	✓
QC-C2500P	93970	\$77.00	QC12 - 25' Wire Harness, 8 & 4 Pin Connector w/12 Wires	QC12	✓
QC-C3000P	93971	\$87.00	QC12- 30' Wire Harness; 8 & 4 Pin Connector w/12 Wires	QC12	✓
	Custom Size*	POA	Other custom sizes available. Consult the factory	QC12	

***Custom Length – Specify Length:**

- QC-C 60" to 80" Add \$5.00 to 93997 • QC-C 81" to 120" Add \$10.00 to 93997 • QC-C 10' to 15' Use Price of 93998
- QC-C 16' to 24 Use Price of 93970 • QC-C 31' to 60' Add \$20.00 to 93971 • QC-C 61' to 200' Add \$40.00 to 93971.





Experience a safer
and more open world

800 346 7707 | www.mckinneyhinge.com
USA Prices Effective March 1, 2024

Transfer Device Solutions

McKinney ElectroLynx® Harnesses & Components

CORBIN RUSSWIN, SARGENT, and YALE Price Code 79

McKinney Catalog #	Part #	Price	Description:	Kit Application:	QS
Miscellaneous Kits					
QC-R001	94034	\$162.00	Molex/Repair/Service Kit	Includes 2, 4, 8 Molex receptacles and plugs (Qty. 10 ea) and the corresponding terminals (100 of each type), extraction tool and pinning assembly guide. Customer must purchase Molex crimper separately.	✓
Miscellaneous Kits					
QC-R002	94035	\$35.00	Extraction Tool 	Quantity 1 Each, Sold one each	✓
QC-R003	94036	\$680.00	Molex Hand Crimp Tool 	Molex tool used to attach terminals to wire (stripped) ends	✓

McKinney Catalog #	Part #	Price	Description:	Kit Application:	QS
Receptacles and Terminals					
QC-RF2	94037	\$37.00	Female Receptacle 2 CKT	Quantity 1 Bag of 100	✓
QC-RF4	94026	\$49.00	Female Receptacle 4 CKT	Quantity 1 Bag of 100	✓
QC-RF8	94027	\$64.00	Female Receptacle 8 CKT	Quantity 1 Bag of 100	✓
QC-RM2	94028	\$37.00	Male Plug 2 CKT	Quantity 1 Bag of 100	✓
QC-RM4	93978	\$49.00	Male Plug 4 CKT	Quantity 1 Bag of 100	✓
QC-RM8	93979	\$64.00	Male Plug 8 CKT	Quantity 1 Bag of 100	✓
QC-FT2024	94029	\$17.00	Female Terminal AWG 20-24	Quantity 1 Bag of 100	✓
QC-FT2630	94030	\$17.00	Female Terminal AWG 26-30	Quantity 1 Bag of 100	✓
QC-MT2024	93980	\$15.00	Male Terminal AWG 20-24	Quantity 1 Bag of 100	✓
QC-MT2630	94031	\$17.00	Male Terminal AWG 26-30	Quantity 1 Bag of 100	✓
QC-DCC	94033	\$31.00	Pinning Assembly Guide	Quantity 1 Bag of 10	✓
POE-MT2024	94016	\$51.00	Male Terminal AWG 20-24	Quantity 1 Bag of 100	✓
POE-RM6	94017	\$43.00	Male Plug 6 CKT	Quantity 1 Bag of 100	✓
POE-RF6	94018	\$43.00	Female Receptacle 6 CKT	Quantity 1 Bag of 100	✓
POE-MT2630	94019	\$24.00	Male Terminal AWG 26-30	Quantity 1 Bag of 100	✓
POE-FT2630	94020	\$24.00	Female Terminal AWG 26-30	Quantity 1 Bag of 100	✓
Door Cord and EPT					
MCK-TSB-C	94002	\$24.00	Door Cord Gray/Black Caps 18"	Quantity 1 Each, Sold 1 Each	✓
MCK-TSB-CXL	94003	\$39.00	Door Cord Gray/Black Caps 36"	Quantity 1 Each, Sold 1 Each	✓
MCK-EPT	94004	\$63.00	Electrical Power Transfer	Quantity 1 Each, Sold 1 Each	✓
MCK-EPTL	94005	\$79.00	Electrical Power Transfer, Long	Quantity 1 Each, Sold 1 Each	✓
MCK-EL-EPT	94006	\$95.00	ElectroLynx EPT -12 wire	Quantity 1 Each, Sold 1 Each	✓
MCK-EL-EPTL	94007	\$124.00	ElectroLynx EPTL Long -12 wire	Quantity 1 Each, Sold 1 Each	✓

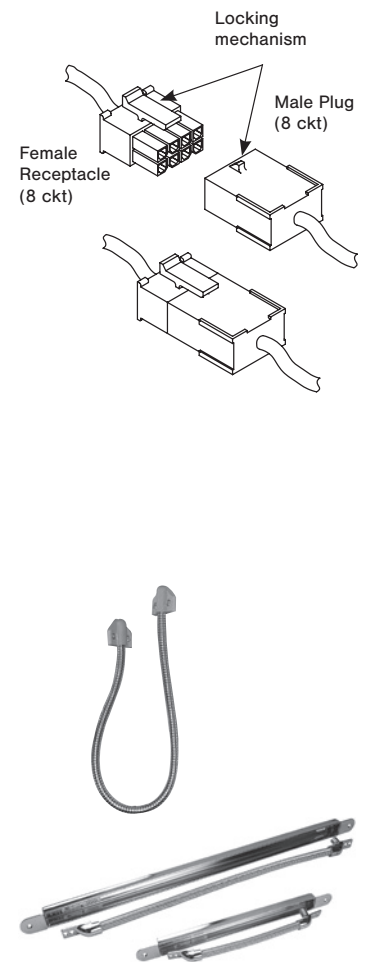

As part of their promise to provide innovative, fast and effective high security solutions to their customers, ASSA ABLOY Group brands offer ElectroLynx®, a universal quick-connect system that simplifies the electrification of the door opening.

ElectroLynx® is a registered trademark of ASSA ABLOY Inc.

800 346 7707 | www.mckinneyhinge.com
USA Prices Effective March 1, 2024

Copyright © 2024, ASSA ABLOY Accessories and Door Controls Group, Inc. All rights reserved. Reproduction in whole or in part without the express written permission of ASSA ABLOY Accessories and Door Controls Group, Inc. is prohibited.

McKinney
ASSA ABLOY

Experience a safer
and more open world

EH-11

Transfer Device Solutions

McKinney ElectroLynx® Power over Ethernet (PoE) Harnesses

Price Code 79

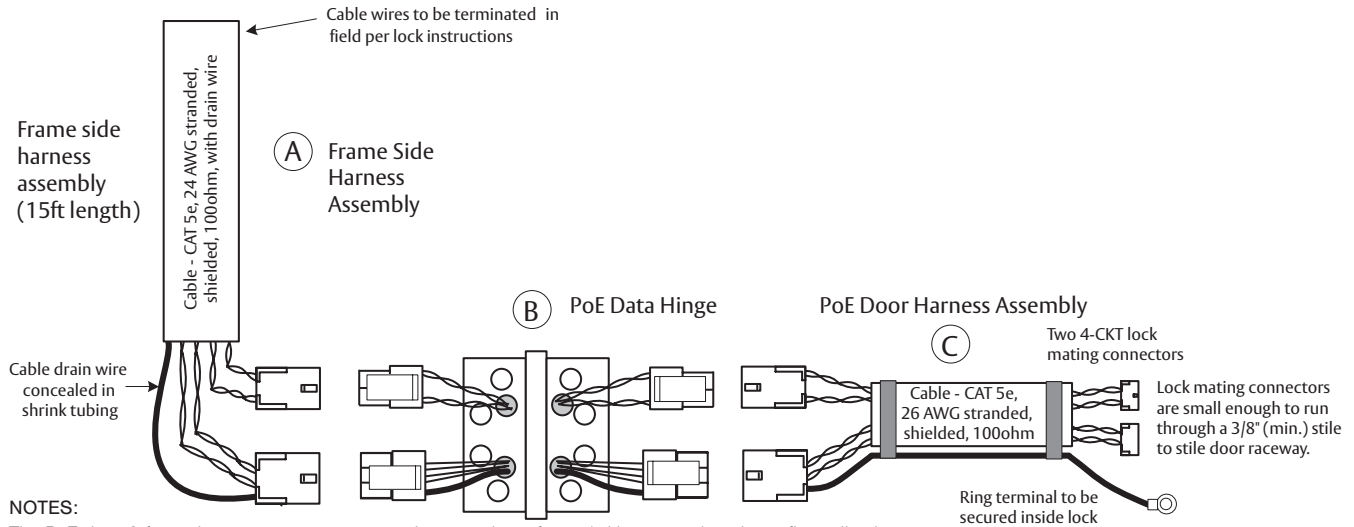

NOTES:

The PoE door & frame harnesses can accommodate a variety of new (with raceway) and retrofit applications. Connectors are small enough to run through a 3/8" (min.) stile-to-stile door raceway. Connects to intelligent Power over Ethernet electromechanical hardware from SARGENT and CORBIN RUSSWIN.

McKinney Catalog #	Part #	Price	Harness Length	Application	Description:	Max Hinge Req'd (not included)	QS
Door Harnesses							
Between Hinge & PoE Lock							
PoE-C206P	94022	\$45.00	30"	20" to 25" door width (doors with 3 butt hinges with PoE hinge in center stile-to-stile raceway to lock prep).	PoE, Cat 5e, 26AWG, Shielded, Screened, 100ohm, Door Harness Assembly	PoE	✓
PoE-C300P	94038	\$46.00	36"	26" to 31" door width (doors with 3 butt hinges with PoE hinge in center stile-to-stile raceway to lock prep).	PoE, Cat 5e, 26AWG, Shielded, Screened, 100ohm, Door Harness Assembly	PoE	✓
PoE-C306P	94039	\$48.00	42"	32" to 36" door width (doors with 3 butt hinges with PoE hinge in center stile-to-stile raceway to lock prep).	PoE, Cat 5e, 26AWG, Shielded, Screened, 100ohm, Door Harness Assembly	PoE	✓
PoE-C400P	94040	\$50.00	48"	37" to 42" door width (doors with 3 butt hinges with PoE hinge in center stile-to-stile raceway to lock prep).	PoE, Cat 5e, 26AWG, Shielded, Screened, 100ohm, Door Harness Assembly	PoE	✓
PoE-C406P	94041	\$51.00	54"	43" to 48" door width (doors with 3 butt hinges with PoE hinge in center stile-to-stile raceway to lock prep).	PoE, Cat 5e, 26AWG, Shielded, Screened, 100ohm, Door Harness Assembly	PoE	✓
PoE-C500P	94042	\$56.00	60"	Door Harness Assembly	PoE, CAT 5e, 26AWG, Shielded, Stranded, 100ohm, Door Frame Harness Assembly	PoE	✓
PoE-C700P	94021	\$57.00	84"	Door Harness Assembly	PoE, CAT 5e, 26AWG, Shielded, Stranded, 100ohm, Door Frame Harness Assembly	PoE	✓
PoE-C1300P	94043	\$58.00	156"	Door Harness Assembly	PoE, CAT 5e, 26AWG, Shielded, Stranded, 100ohm, Door Frame Harness Assembly	PoE	✓
EPT Harness							
PoE-CEPT30	94023	\$98.00	360"	EPT Harness Assembly	PoE, CAT 5e, 26AWG, Shielded, Stranded, 100ohm, Door Frame Harness Assembly	PoE	✓
EPT Harness Frame Harness							
Between hinge and PoE Network Cable & Switch							
PoE-C1500P	94044	\$52.00	180"	From the hinge location, up the jamb to the wall/ceiling.	PoE, Cat 5e, 26AWG, Shielded, Screened, 100ohm, Door Harness Assembly	PoE	✓
	*Custom Size	POA		Custom sizes available. Consult factory.		PoE	

The door harness connectors are small enough to run through a 3/8" (minimum) stile-to-stile door raceway.

*See the McKinney Catalog for additional finishes and hinge types.

Note: One hinge, door harness and frame harness are required for each PoE opening.

***Custom Length – Specify Length:**

- POE-C2500P – 300 in (25 FT) Add \$20 to 94044.
- Up to 20' Use next higher foot price
- 61" to 83" Use 94042 Price
- 85" to 155" Use 94021 Price
- 157" to 359" Use Price of 94043
- 361" and over Add \$30 to 94023.



Experience a safer and more open world

800 346 7707 | www.mckinneyhinge.com
USA Prices Effective March 1, 2024

Transfer Device Solutions

McKinney ElectroLynx® Power over Ethernet (PoE)

Harnesses with Loose RJ-45 Connectors

Price Code 79

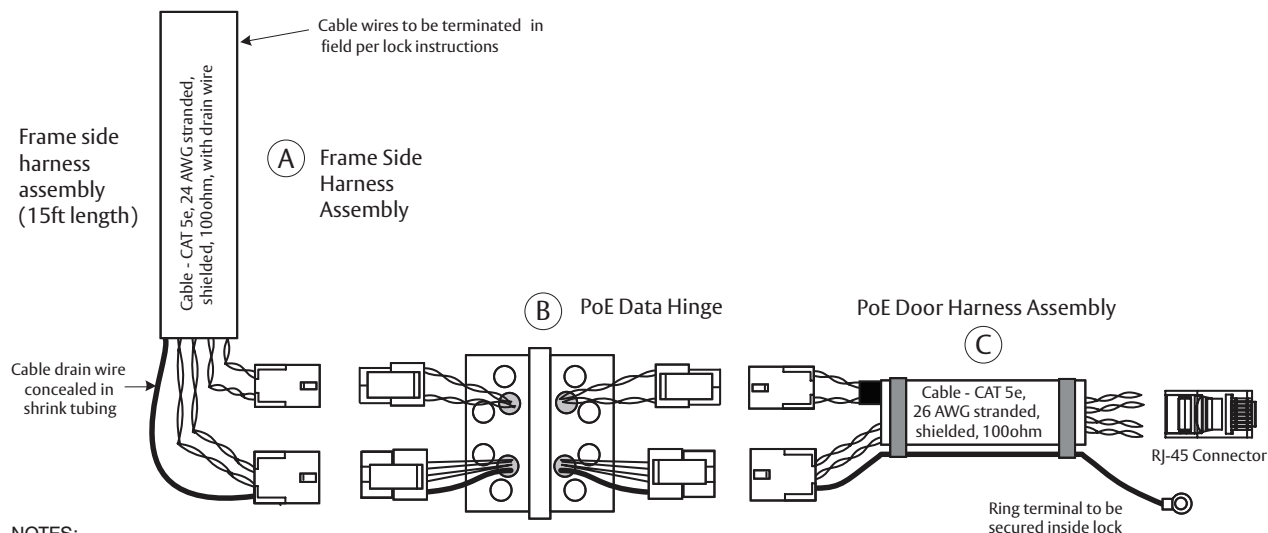

NOTES:

The PoE door & frame harnesses can accommodate a variety of new (with raceway) and retrofit applications. Connects to next generation Power over Ethernet electro-mechanical hardware from SARGENT and CORBIN RUSSWIN including: Corbin Russwin IN220, Corbin Russwin Access 700 PIP1, SARGENT IN220, SARGENT Passport 1000 P1.

McKinney Catalog #	Part #	Price	Harness Length	Application	Description:	Max Hinge Req'd (not included)	Q S
Door Harnesses				Between Hinge & PoE Lock			
PoE-C206RJ	94202	\$45.00	30"	20" to 25" door width (doors with 3 butt hinges with PoE hinge in center stile-to-stile raceway to lock prep).	PoE, Cat 5e, 26AWG, Shielded, Screened, 100ohm, Door Harness Assembly	PoE	✓
PoE-C300RJ	94203	\$46.00	36"	26" to 31" door width (doors with 3 butt hinges with PoE hinge in center stile-to-stile raceway to lock prep).	PoE, Cat 5e, 26AWG, Shielded, Screened, 100ohm, Door Harness Assembly	PoE	✓
PoE-C306RJ	94204	\$48.00	42"	32" to 36" door width (doors with 3 butt hinges with PoE hinge in center stile-to-stile raceway to lock prep).	PoE, Cat 5e, 26AWG, Shielded, Screened, 100ohm, Door Harness Assembly	PoE	✓
PoE-C400RJ	94205	\$50.00	48"	37" to 42" door width (doors with 3 butt hinges with PoE hinge in center stile-to-stile raceway to lock prep).	PoE, Cat 5e, 26AWG, Shielded, Screened, 100ohm, Door Harness Assembly	PoE	✓
PoE-C406RJ	94206	\$51.00	54"	43" to 48" door width (doors with 3 butt hinges with PoE hinge in center stile-to-stile raceway to lock prep).	PoE, Cat 5e, 26AWG, Shielded, Screened, 100ohm, Door Harness Assembly	PoE	✓
PoE-C500RJ	94207	\$56.00	60"	Door Harness Assembly	PoE, CAT 5e, 26AWG, Shielded, Stranded, 100ohm, Door Frame Harness Assembly	PoE	✓
PoE-C700RJ	94201	\$57.00	84"	Door Harness Assembly	PoE, CAT 5e, 26AWG, Shielded, Stranded, 100ohm, Door Frame Harness Assembly	PoE	✓
PoE-C1300RJ	94208	\$58.00	156"	Door Harness Assembly	PoE, CAT 5e, 26AWG, Shielded, Stranded, 100ohm, Door Frame Harness Assembly	PoE	✓
EPT Harness							
PoE-CEPT30RJ	94200	\$98.00	360"	EPT Harness Assembly	PoE, CAT 5e, 26AWG, Shielded, Stranded, 100ohm, Door Frame Harness Assembly	PoE	✓
	*Custom Size	POA		Custom sizes available. Consult factory.		PoE	

Note: One hinge, door harness and frame harness are required for each PoE opening.

***Custom Length, Specify Length:**

- 61" to 83" Use 94201 Price • 85" to 155" Use 94208 Price • 157" to 359" Use Price of 94200 • 361" and over Add \$30 to 94200.

Transfer Device Solutions

McKinney ElectroLynx® Power over Ethernet (PoE)

Harnesses with RJ-45 Connectors Attached

Price Code 79

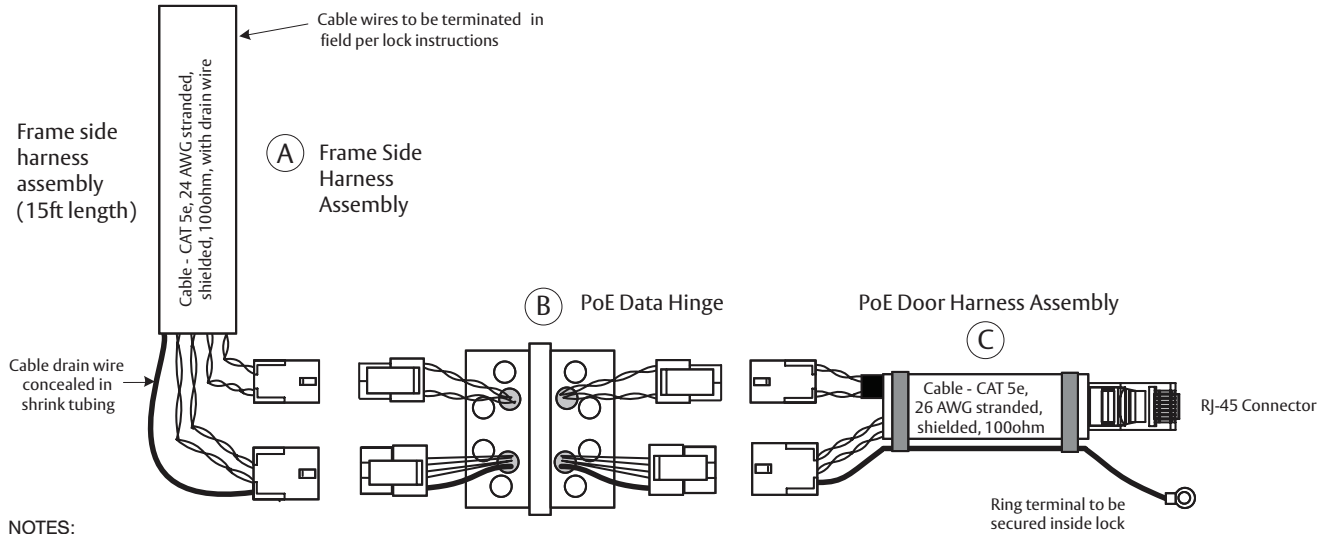

NOTES:

The PoE door & frame harnesses can accommodate a variety of new (with raceway) and retrofit applications. Connects to next generation Power over Ethernet electro-mechanical hardware from SARGENT and CORBIN RUSSWIN including: Corbin Russwin IN220, Corbin Russwin Access 700 PIP1, SARGENT IN220, SARGENT Passport 1000 P1.

McKinney Catalog #	Part #	Price	Harness Length	Application	Description:	Max Hinge Req'd (not included)	QS
Door Harnesses							
Between Hinge & PoE Lock							
PoE-C206PRJ	94210	\$45.00	30"	20" to 25" door width (doors with 3 butt hinges with PoE hinge in center stile-to-stile raceway to lock prep).	PoE, Cat 5e, 26AWG, Shielded, Screened,100ohm, Door Harness Assembly	PoE	✓
PoE-C300PRJ	94211	\$46.00	36"	26" to 31" door width (doors with 3 butt hinges with PoE hinge in center stile-to-stile raceway to lock prep).	PoE, Cat 5e, 26AWG, Shielded, Screened,100ohm, Door Harness Assembly	PoE	✓
PoE-C306PRJ	94212	\$48.00	42"	32" to 36" door width (doors with 3 butt hinges with PoE hinge in center stile-to-stile raceway to lock prep).	PoE, Cat 5e, 26AWG, Shielded, Screened,100ohm, Door Harness Assembly	PoE	✓
PoE-C400PRJ	94213	\$50.00	48"	37" to 42" door width (doors with 3 butt hinges with PoE hinge in center stile-to-stile raceway to lock prep).	PoE, Cat 5e, 26AWG, Shielded, Screened,100ohm, Door Harness Assembly	PoE	✓
PoE-C406PRJ	94214	\$51.00	54"	43" to 48" door width (doors with 3 butt hinges with PoE hinge in center stile-to-stile raceway to lock prep).	PoE, Cat 5e, 26AWG, Shielded, Screened,100ohm, Door Harness Assembly	PoE	✓
PoE-C500PRJ	94215	\$56.00	60"	Door Harness Assembly	PoE, CAT 5e, 26AWG, Shielded, Stranded, 100ohm, Door Frame Harness Assembly	PoE	✓
PoE-C700PRJ	94216	\$57.00	84"	Door Harness Assembly	PoE, CAT 5e, 26AWG, Shielded, Stranded, 100ohm, Door Frame Harness Assembly	PoE	✓
PoE-C1300PRJ	94217	\$58.00	156"	Door Harness Assembly	PoE, CAT 5e, 26AWG, Shielded, Stranded, 100ohm, Door Frame Harness Assembly	PoE	✓
	*Custom Size	POA		Custom sizes available. Consult factory.		PoE	

Note: One hinge, door harness and frame harness are required for each PoE opening.

***Custom Length – Specify Length:**

Custom cables less than 60" are priced at the 60" price.

For QC Cable Only \$1.38 per foot (code 79X) • Example: 1000 FT 12 WIRE QC-CABLE ONLY

• 61" to 83" Use 94216 Price • 85" to 155" Use 94217 Price • 157" to 359" Add \$20 to 94217 • 361" and over Add \$30 to 94217.



Experience a safer and more open world

800 346 7707 | www.mckinneyhinge.com
USA Prices Effective March 1, 2024

TA392

Price Code 30

5" x 4½"
127 mm x 114.30 mm

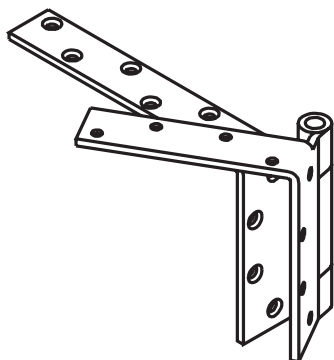

Anchor plate for jamb and door header permits use of surface applied holders and closers.

Part Number	Finish	Price Each	Hand	Case Qty.	Box Qty.	Case Wgt.	Q S
75500	32D	\$346.50	R.H.	4 SETS	1 SET	28	✓
75501	32D	\$346.50	L.H.				✓

Set consists of top anchor, intermediate and bottom hinge for square edge door application. Anchor Hinge Sets are not available in brite finishes

Non-Ferrous Bearing

TA393

Price Code 30

5" x 4½"
127 mm x 114.30 mm

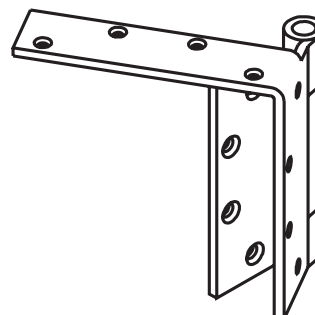

Anchor plate for jamb header only, permits the use of holders and closers concealed in the top of the door.

Part Number	Finish	Price Each	Hand	Case Qty.	Box Qty.	Case Wgt.	Q S
R.H. 75581	32D	\$611.50	L.H.	4 SETS	1 SET	28	
L.H. 75582	32D	\$611.50					✓

Set consists of top anchor, intermediate and bottom hinge for square edge door application. Anchor Hinge Sets are not available in brite finishes.

Non-Ferrous Bearing Hinges 4" Door Leg

TA394

Price Code 30

5" x 4½"
127 mm x 114.30 mm

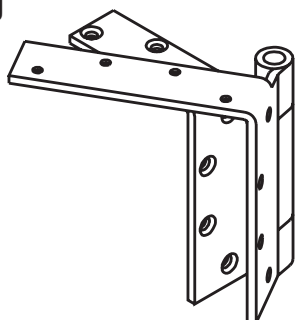

Anchor plate for both jamb and door header. Permits use of both holders – closers.

Part Number	Finish	Price Each	Hand	Case Qty.	Box Qty.	Case Wgt.	Q S
75455	32D	\$611.50	R.H.	4 SETS	1 SET	28	
75456	32D	\$611.50	L.H.				✓

Set consists of top anchor, intermediate and bottom hinge for square edge door application. Anchor Hinge Sets are not available in brite finishes.

Heavy Weight Beveled Edge Non-Ferrous Bearing

TA5392

Price Code 30

5" x 4½"
127 mm x 114.30 mm

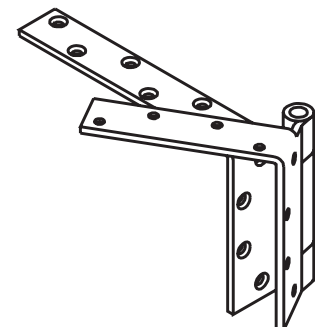

Anchor plate for both jamb and door header permits use of surface applied holders and closers.

Part Number	Finish	Price Each	Hand	Case Qty.	Box Qty.	Case Wgt.	Q S
75544	32D	\$370.50	R.H.	4 SETS	1 SET	28	✓
75545	32D	\$370.50	L.H.				✓

Set consists of top anchor, intermediate and bottom hinge for beveled (½" in 2") edge doors on hinge side application. Anchor Hinge Sets are not available in brite finishes.

Steel Anchor Hinge Bearing

TA792

Price Code 30

5" x 4½"
127 mm x 114.30 mm

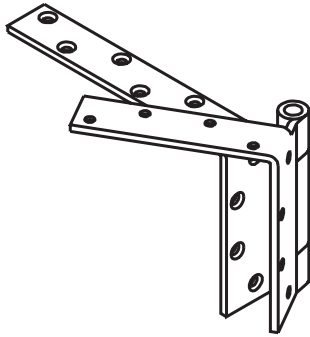

Anchor plate for jamb and door header permits use of surface applied holders and closers.

Part Number	Finish	Price Each	Hand	Case Qty.	Box Qty.	Case Wgt.	Q S
75492	26D	\$233.50	R.H.	4 SETS	1 SET	28	✓
75493	26D	\$233.50	L.H.				✓

Set consists of top anchor, intermediate and bottom hinge for square edge door application. Anchor Hinge Sets are not available in brite finishes.

Steel Anchor Hinge 4" Door Leg

TA794

Price Code 30

5" x 4½"
127 mm x 114.30 mm

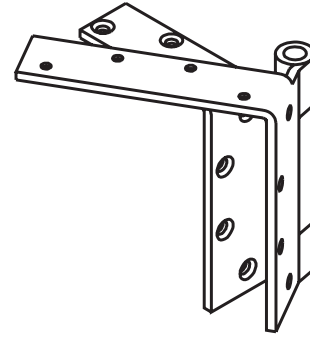

Anchor plate for both jamb and door header permits use of surface applied holders and closers.

Part Number	Finish	Price Each	Hand	Case Qty.	Box Qty.	Case Wgt.	Q S
75836	26D	\$378.50	R.H.	4 SETS	1 SET	28	✓
75837	26D	\$378.50	L.H.				✓

Set consists of top anchor, intermediate and bottom hinge for square edge door application. Anchor Hinge Sets are not available in brite finishes.

Steel Heavy Weight Beveled Edge Bearing

TA5792

Price Code 30

5" x 4½"
127 mm x 114.30 mm

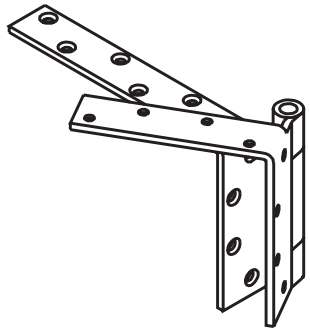

Anchor plate for jamb and door header permits use of surface applied holders and closers.

Part Number	Finish	Price Each	Hand	Case Qty.	Box Qty.	Case Wgt.	Q S
75532	26D	\$257.50	R.H.	4 SETS	1 SET	28	✓
75533	26D	\$257.50	L.H.				✓

Set consists of top anchor, intermediate and bottom hinge for beveled (½" in 2") edge doors on hinge side application. Anchor Hinge Sets are not available in brite finishes.

Reinforcing Pivots

8540 Price Code 20

4" 101.60 mm

Part Number	Finish	Price Each	Hand	Case Qty.	Box Qty.	Case Wgt.	Q S
63550	15	\$25.00	R.H.	12	1	22	✓
63551	15	\$25.00	L.H.				✓

8545 Price Code 20

4½" 114.30 mm

Part Number	Finish	Price Each	Hand	Case Qty.	Box Qty.	Case Wgt.	Q S
63552	15	\$28.00	R.H.	12	1	22	✓
63553	15	\$28.00	L.H.				✓

5540 Price Code 20

4" 101.60 mm

Part Number	Finish	Price Each	Hand	Case Qty.	Box Qty.	Case Wgt.	Q S
63554	32D	\$65.00	R.H.	12	1	22.8	✓
63555	32D	\$65.00	L.H.				✓

5545 Price Code 20

4½" 114.30 mm

Part Number	Finish	Price Each	Hand	Case Qty.	Box Qty.	Case Wgt.	Q S
63556	32D	\$68.00	R.H.	12	1	22.8	✓
63557	32D	\$68.00	L.H.				✓

McKinney
ASSA ABLOY

Experience a safer
and more open world

800 346 7707 | www.mckinneyhinge.com
USA Prices Effective March 1, 2024

Copyright © 2024, ASSA ABLOY Accessories and Door Controls Group, Inc. All rights reserved. Reproduction in whole or in part without the express written permission of ASSA ABLOY Accessories and Door Controls Group, Inc. is prohibited.

Steel 5 Knuckle Standard Weight

TA2774

Price Code 50

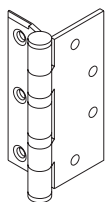

Size	Part Number	Finish	Price Each	Case Qty.	Box Qty.	Case Wgt.	Q S
4½" 114.30 mm	57880	P	\$56.25	24	3	23	✓
	57884	26D	\$56.25				✓

Heavy Weight 5 Knuckle Non-Ferrous Bearing

T4A3384

Price Code 50

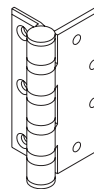

Size	Part Number	Finish	Price Each	Case Qty.	Box Qty.	Case Wgt.	Q S
4½" 114.30 mm	70771	32D	\$165.00	24	3	40	
5" 127 mm	61663	32D	\$203.50	24	3	40	

Standard Weight 5 Knuckle Non-Ferrous Bearing

TA3374

Price Code 50

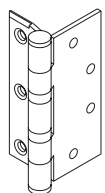

Size	Part Number	Finish	Price Each	Case Qty.	Box Qty.	Case Wgt.	Q S
4½" 114.30 mm	61415	32D	\$123.00	24	3	28	

Steel Heavy 5 Knuckle Weight Bearings

T4A3784

Price Code 50

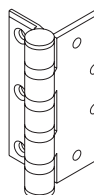

Size	Part Number	Finish	Price Each	Case Qty.	Box Qty.	Case Wgt.	Q S
4½" 114.30 mm	58220	P	\$93.00	24	3	31	
	58223	26D	\$85.00				
5" 127 mm	58242	26D	\$107.50	24	3	36	

Steel 5 Knuckle Swing Clear Heavy Weight Bearing

T4A3789

Price Code 30

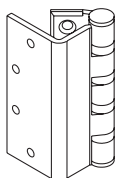

Size	Part Number	Finish	Price Each	Case Qty.	Box Qty.	Case Wgt.	Q S
5" 127 mm	73034	26D	\$176.50	24	3	47	

Standard Weight 5 Knuckle Non-Ferrous Bearing

TA2372

Price Code 50

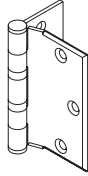

Size	Part Number	Finish	Price Each	Case Qty.	Box Qty.	Case Wgt.	Q S
4½" 114.30 mm	57692	26D	\$174.00	24	3	30	
	57696	32D	\$166.00				
5" 127 mm	57697	32D	\$175.00	24	3	38	

Steel Standard Weight 5 Knuckle

TA2772

Price Code 50

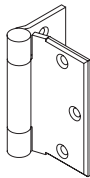

Size	Part Number	Finish	Price Each	Case Qty.	Box Qty.	Case Wgt.	Q S
4½" 114.30 mm	57710	P	\$51.25	24	3	30	✓
	57714	3	\$59.25				
	57715	10	\$59.25				
	57721	10B	\$66.25				
5" 127 mm	57717	26D	\$51.25	24	3	38	✓
	57833	26D	\$58.75				✓

Heavy Weight 5 Knuckle Non-Ferrous Bearing

T4A3382

Price Code 50

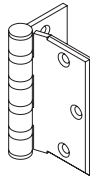

Size	Part Number	Finish	Price Each	Case Qty.	Box Qty.	Case Wgt.	Q S
4½" 114.30 mm	61563	32D	\$200.00	24	3	50	✓
5" 127 mm	61596	26D	\$228.00	24	3	57	
	61582	32D	\$220.00				

Steel Heavy Weight 5 Knuckle Bearing

T4A3782

Price Code 50

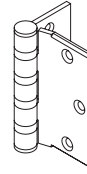

Size	Part Number	Finish	Price Each	Case Qty.	Box Qty.	Case Wgt.	Q S
4½" 114.30 mm	58118	26	\$183.00	24	3	38	
	58107	26D	\$175.00				✓
5" 127 mm	72287	26D	\$195.00	24	3	48	
6" 152.4 mm for 1¾" ^{44.4 mm} door	58181	26D	\$235.00	12	3	43	✓
6" 152.4 mm for 2¼" ^{51.05 mm} door	72339	26D	\$235.00	12	3	43	✓

Heavy Weight 5 Knuckle Steel Bearing

T4A3796

Price Code 50

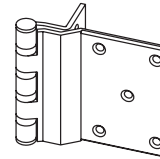

Size	Part Number	Finish	Price Each	Case Qty.	Box Qty.	Case Wgt.	Q S
5" 127 mm	73522	26D	\$131.50	12		35	✓

Steel Back Plates

BP-10

BP-11

Price Code 50



Size	Product	Part Number	Finish	Price Each	Case Qty.	Box Qty.	Case Wgt.	Q S
4½" 114.30 mm	BP-10 (TA2772) (T4A3782)	63241	P	\$8.00	AS ORDERED			
		63243	10B	\$10.50				
		63240	26D	\$8.00				✓
5" 127 mm		63247	26D	\$9.00	AS ORDERED		✓	
5" 127 mm	BP-11 (T4A3796)	63257	10	\$11.50	AS ORDERED			
		63255	26D	\$9.00				

McKinney
ASSA ABLOY

Experience a safer
and more open world

800 346 7707 | www.mckinneyhinge.com
USA Prices Effective March 1, 2024

Copyright © 2024, ASSA ABLOY Accessories and Door Controls Group, Inc. All rights reserved. Reproduction in whole or in part without the express written permission of ASSA ABLOY Accessories and Door Controls Group, Inc. is prohibited.

Steel Standard Weight 5 Knuckle Bearing

TA2771
Price Code 50

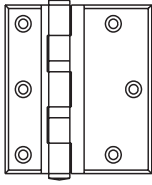

Size	Part Number	Finish	Price Each	Case Qty.	Box Qty.	Case Wgt.	Q S
4½" 114.30 mm	57525	P	\$66.25	24	3	27	✓
	57533	26D	\$66.25				
5" 127 mm	57577	26D	\$93.75	24	3	35	

Steel Heavy Weight 5 Knuckle Bearing

T4A3781
Price Code 50

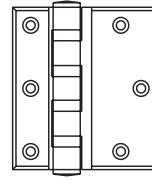

Size	Part Number	Finish	Price Each	Case Qty.	Box Qty.	Case Wgt.	Q S
4½" 114.30 mm	58066	26D	\$175.00	24	3	37	
	58075	P	\$203.00				
5" 127 mm	72228	26D	\$195.00	24	3	44	

Heavy Weight 5 Knuckle Non-Ferrous Bearing

T4A3381
Price Code 50

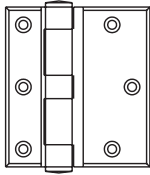

Size	Part Number	Finish	Price Each	Case Qty.	Box Qty.	Case Wgt.	Q S
4½" 114.30 mm	61508	32D	\$230.00	24	3	46	

T4B3781 Price Code 50

6"
152.40 mm

Part Number	Finish	Price Each	Case Qty.	Box Qty.	Case Wgt.	Q S
72259	26D	\$225.00	18	3	48	

Steel Standard Weight Full Mortise Single Acting

1502

Price Code 71

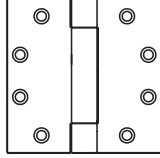

Size	Part Number	Finish	Price Each	Case Qty.	Box Qty.	Case Wgt.	Q S
4" x 4" 101.60 mm x 101.60 mm	155905	10B	\$40.75	48	3	40	✓
	155907	26D	\$25.75				✓
4 1/2" x 4" 114.30 mm x 101.60 mm	156002	P	\$25.75	48	3	54	✓
	156004	4	\$33.75				✓
	156006	10B	\$40.75				✓
	156006E	10BE	\$33.75				✓
	156009	26	\$33.75				✓
	156008	26D	\$25.75				✓
	156007	15	\$33.75				✓
	56537	BSP	\$40.75				✓
4 1/2" x 4 1/2" 114.30 mm x 114.30 mm	156017	P	\$25.75	48	3	54	✓
	156025	3	\$33.75				✓
	156019	4	\$33.75				✓
	156020	10	\$33.75				✓
	156021	10B	\$40.75				✓
	156021E	10BE	\$33.75				✓
	156024	26	\$33.75				✓
	156023	26D	\$25.75				✓
	56514	BSP	\$40.75				✓
	156022	15	\$33.75				✓

Stainless Steel Standard Weight

1552

Price Code 71

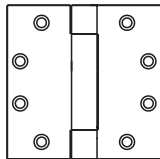

Size	Part Number	Finish	Price Each	Case Qty.	Box Qty.	Case Wgt.	Q S
4 1/2" x 4" 114.30 mm x 101.60 mm	156056	32D	\$46.75	48	3	54	✓
4 1/2" x 4 1/2" 114.30 mm x 114.30 mm	156080	32D	\$46.75	48	3	56	✓

Allen Wrench set for 1502 / 1552 Spring Hinges
MK08808B @ \$2.25 per set

Set Screw only for "old style"
MK07574 @ \$0.55 each net

Cross Pin only for "new style"
MK10328 @ \$0.55 each net

Discontinued Spring Hinge Options:

HT Hospital Tip
1502-R Reverse Spring
TRS - Tamper Resistant



Experience a safer
and more open world

MacPro® Spring Hinges

MPS60

Price Code 57



Size	Part Number	Finish	Price Each	Case Qty.	Box Qty.	Case Wgt.	Q S
4 1/2" x 4" 114.30 mm x 101.60 mm	76388	15	\$10.40	48	3	54	✓
4 1/2" x 4 1/2" 114.30 mm x 114.30 mm	76380	P	\$7.90	48	3	54	✓
	76385	15	\$10.40				✓
	76378	26D	\$7.90				✓
	76378E	10BE	\$10.40				✓
	56506	BSP	\$10.40				✓

MPS679

Price Code 57



Set includes 2 Spring Hinges and 1 Bearing Hinge.

Size	Part No.	Fin.	Price Per Set	Case Qty.	Box Qty.	Case Wgt.	Q S
4 1/2" x 4 1/2" 114.30 mm x 114.30 mm	76379	26D	\$19.20	16 SETS	1 SET	30	✓

Price Code 57

MK10379 Cross pin for MPS60
Wrench only

\$0.35 ea.
\$0.60 ea.

Steel Door Spring Adjustable Tension

Price Code 72

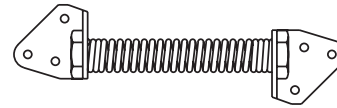

Size	Part Number	Fin.	Price Each	Case Qty.	Box Qty.	Case Wgt.	Q S	
9" 228.6 mm	451	155371	D4	\$22.00	50	-	53	✓
11" 279.4 mm	452	155381	D4	\$23.00	25	-	34	✓
13" 330.2 mm	453	155401	D4	\$24.00	25	-	38	✓

Steel Full Mortise Double Acting

1001

Price Code 72

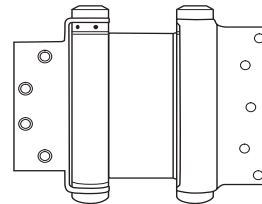

Size	Part Number	Finish	Price Each	Case Qty.	Box Qty.	Case Wgt.	Q S
6" x 4 1/2" 152.4 mm x 114.30 mm	155754	26D	\$125.00	12	12	41	✓

Top Pivot and Socket

EP-5J

Price Code 11

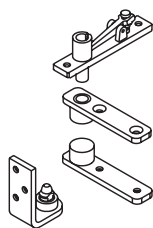

Size	Part Number	Finish	Price Per Set	Case Qty.	Box Qty.	Case Wgt.	Q S
	63346	26D	\$145.00	20	1	38	✓

MK07510 is a bag of 20 screws for complete unit \$4.28

For Cylindrical or Bored Locks

CSS-9

Price Code 11

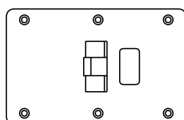

May not work with mortise locks. Consult the factory for mortise lock application. Not for use with deadbolt.

05319 Box and Plunger Assembly for DS-6 or CSS-9 \$70.00
 09272 Box only \$10.00
 09501 Springs only \$2.00

22708 1/2x12-32 Torx MS 2D \$0.95 ea net

Size	Part Number	Finish	Price Each	Description	Case Qty.	Box Qty.	Case Wgt.	Q S		
5 3/4" 146 mm	63330	26D	\$242.00	Center Hung	As Ordered			✓		
	63332	26D	\$242.00	Offset Hung				✓		
5 7/8" 149.225 mm	63313	26D	\$242.00	Center Hung				✓		
	63293	26D	\$242.00	Offset Hung				✓		
6 3/4" 171.40 mm	63331	26D	\$267.00	Center Hung				✓		
	63329	26D	\$267.00	Offset Hung						
Custom Size	63350	26D	\$355.00	Custom Sizes						

Emergency Door Stop

DS-6

Price Code 11



Consult the factory for availability of custom sizes. Custom Engineering and Set Up charges may apply.

Size	Part Number	Finish	Price Each	Case Qty.	Box Qty.	Case Wgt.	Q S
	63345	26D	\$145.00	20		12	✓

Double Lipped Strike

DLS-8

Price Code 11

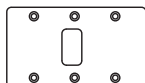

May not work with mortise locks. Consult the factory for mortise lock application. Not for use with deadbolt.

Consult the factory for availability of custom sizes. Custom Engineering and Set Up charges may apply.

Size	Part Number	Finish	Price Each	Description	Case Qty.	Box Qty.	Case Wgt.	Q S		
5 3/4" 146 mm	63315	26D	\$75.00	Center Hung	As Ordered			✓		
	63319	26D	\$75.00	Offset Hung				✓		
6 3/4" 171.40 mm	63316	26D	\$85.00	Center Hung				✓		
5 7/8" 149.225 mm	63342	26D	\$85.00	Center Hung				✓		
7 3/4" 196.85 mm	63340	26D	\$90.00	Center Hung				✓		
8 1/4" 209.55 mm	63341	26D	\$90.00	Center Hung				✓		
Custom Size	63351	26D	\$120.00	Custom Size						

MK22708 8-32X1/2 TORX SC FOR CSS-9 /DLS8 \$0.95 each

Raised Barrel

Price Code 50

Size	Part Number	Finish	Price Each	Case Qty.	Box Qty.	Case Wgt.	Q S
4 1/2" x 4 1/2" 114.30 mm x 114.30 mm	55957 RBT4A2714	26D	\$43.75	3	48	55	✓
	58436 RBT4A3786	26D	\$73.00	3	24	35	✓

Pocket Hinge

PH-4

Price Code 11

For Narrow Stile

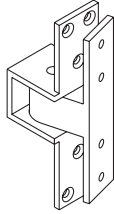

Size	Part Number	Finish	Price Each	Case Qty.	Box Qty.	Case Wgt.	Q S
	63539	26D	\$355.00	AS ORDERED			✓

StormPro® Tornado Resistant Hinges

All StormPro® products should be ordered as a complete integrated unit including the frame and door along with other StormPro® hardware. StormPro® hinges are a required component of the certified StormPro® system.

SP3386

Price Code 50

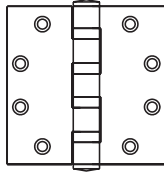

Size	Part Number	Finish	Price Each	Case Qty.	Box Qty.	Case Wgt.	Q S
4 1/2" x 4 1/2" 114.30 mm x 114.30 mm	73972	32D	\$145.00	3	24	37	
	73976	32D	\$154.00	3	24	37	✓
4 1/2" x 4 1/2" NRP 114.30 mm x 114.30 mm	73982	32D	\$170.00	3	24	43	
	73982N	32D-NRP	\$174.00	3	24	43	
5" x 4 1/2" 127 mm x 114.30 mm		32D	\$155.00	3	24		
		32D	\$155.00	3	24		

4 1/2" Wide Throw (up to 8")

5" Wide Throw (up to 8")

SP3786

Price Code 50

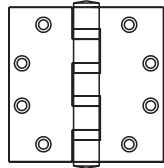

Size	Part Number	Finish	Price Each	Case Qty.	Box Qty.	Case Wgt.	Q S
4 1/2" x 4 1/2" 114.30 mm x 114.30 mm	73969	26D-NRP	\$81.00	3	24	35	✓
	73970	P	\$77.00	3	24	35	
	73971	26D	\$77.00	3	24	35	✓
5" x 4 1/2" 127 mm x 114.30 mm	73980	P	\$92.00	3	24	41	
	73981	26D	\$92.00	3	24	41	
4 1/2" Wide Throw (up to 8")	73981N	26D-NRP	\$96.00	3	24	41	
		26D	\$155.00	3	24		
5" Wide Throw (up to 8")		26D	\$155.00	3	24		

Additional sizes available:

4-1/2"x5", 4-1/2"x6", 4-1/2"x7", 4-1/2"x8", 5"x5", 5"x6", 5"x7", 5"x8"
Standard finishes are 32D and 26D, other finishes are available upon request. Electrification is available on hinges up to and including 6" wide. Add \$7.00 to 26D price for BSP or 10B, 10, 10A. Non-Removable Pin (NRP) is available as an option. Stainless steel machine screws are standard.

Interim Hinges

Price Code 50



Door or Frame Leaf 5"	Opposite Leaf Trimmed To: 4 1/2"	Quick Ship
57470	TA2714 26D	\$48.00 ✓
57480	T4A3786 26D	\$63.00 ✓
57475	T4A3386 32D	\$113.50 ✓

Also available with 4 1/2" Door or Frame Leaf with the Opposite Leaf Trimmed to 4".

For finishes not listed, use \$8.00 over 26D price

All interim hinges are supplied with NRP set screw and no hole bottom plug which allow them to be reversible. Leaves are trimmed the same dimension from the top and bottom of that leaf - otherwise a complete special must be manufactured. Check for existence of available special part numbers which may have previously been manufactured.

Cam Lift Hinges

Price Code 20



Size	Part Number	Finish	Price Each	Model Number	Hand	Box Qty.	Q/S
4 1/2" x 4 1/2" 114.30 mm x 114.30 mm	66000	32D	\$82.00	MKCL134LH	LH	2	✓
	66001	32D	\$82.00	MKCL134RH	RH	2	✓
5" x 4 1/2" 127 mm x 114.30 mm	66002	32D	\$108.00	MKCL180LH	LH	2	✓
	66003	32D	\$108.00	MKCL180RH	RH	2	✓
	66004	32D	\$145.00	MKCL250LH	LH	2	✓
	66005	32D	\$145.00	MKCL250RH	RH	2	✓
	66006	32D	\$145.00	MKCL2500LH	LH	2	✓
	66007	32D	\$145.00	MKCL2500RH	RH	2	✓

McKinney
ASSA ABLOY

Experience a safer
and more open world

800 346 7707 | www.mckinneyhinge.com

USA Prices Effective March 1, 2024

Specialty Hinges & Residential

1400 Price Code 14

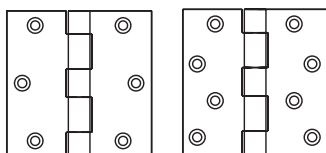

Staggered Hole Pattern
on 4" x 4" Size

1414 Price Code 14

1/4" Radius

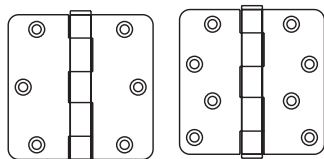

Staggered Hole Pattern
on 4" x 4" Size

1458 Price Code 14

5/8" Radius

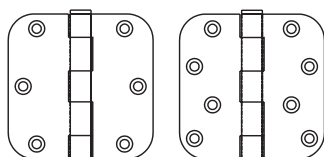

Staggered Hole Pattern
on 4" x 4" Size

Residential Hinges available only in finishes shown above. Contract Grade Hinge Discount does not apply to Residential Grade Hinges. NOTE: Unlisted finishes for residential hinges P.O.A. Consult the Factory on minimum requirements.

Size	Part Number	Finish	Price Each	Case Qty.	Box Qty.	Case Wgt.	Q S
3 1/2" x 3 1/2" 88.90 mm x 88.90 mm	56689	4	\$5.50	50	2	26	✓
	56683	10B*	\$5.50				✓
	56692	26	\$5.50				✓
	56288	26D	\$4.50				✓
	56529	BSP	\$5.50				✓
4" x 4" 101.60 mm x 101.60 mm	56688	P	\$5.50	50	2	26	✓
	56737	10B*	\$6.00				✓
	56748	26D	\$5.00				✓

Size	Part Number	Finish	Price Each	Case Qty.	Box Qty.	Case Wgt.	Q S
3 1/2" x 3 1/2" 88.90 mm x 88.90 mm	56716	10B*	\$6.50	50	2	26	✓
	56719	26	\$6.50				✓
	56821	26D	\$5.50				✓
4" x 4" 101.60 mm x 101.60 mm	56768	4	\$7.00	50	2	52	✓
	56769	10B*	\$7.00				✓
	56773	26D	\$6.00				✓
	56773	26D	\$6.00				✓

Size	Part Number	Finish	Price Each	Case Qty.	Box Qty.	Case Wgt.	Q S
3 1/2" x 3 1/2" 88.90 mm x 88.90 mm	56870	3	\$7.50	50	2	26	✓
	56861	10B*	\$7.50				✓
	56868	26D	\$6.50				✓
	56869	BSP	\$14.50				✓
4" x 4" 101.60 mm x 101.60 mm	56922	26D	\$7.00	50	2	52	✓

*Residential grade 10B Finish.

Residential Grade Swing Clear Hinges

T2895 Price Code 50

Size	Part Number	Finish	Price Each	Description	Case Qty.	Box Qty.	Case Wgt.	Q S
3 1/2" 88.90 mm	57060	US4	\$40.75	1/4RC NL	24	3	19	✓
	57061	US4	\$40.75	5/8RC NL				✓
	57062	US15	\$40.75	1/4RC NL				✓
	57063	US15	\$40.75	5/8RC NL				✓
	57064	10BE	\$40.75	1/4RC NL				✓
	57065	10BE	\$40.75	5/8RC NL				✓

T2895 Price Code 50

Size	Part Number	Finish	Price Each	Description	Case Qty.	Box Qty.	Case Wgt.	Q S
4" 101.60 mm	57066	US4	\$40.75	1/4RC NL	24	3	36	✓
	57067	US15	\$40.75	1/4RC NL				✓
	57068	U10BE	\$40.75	1/4RC NL				✓

0 Swage Hinges RCTA2314 Price Code 50

Size	Part Number	Finish	Price Each	Case Qty.	Box Qty.	Case Wgt.	Q S
4 1/2" x 4" 114.30 mm x 101.60 mm	59505	32D-NRP	\$40.00	48	3	53	✓
	59506	D3-NRP	\$48.00				✓
	59507	D4-NRP	\$48.00				✓

Residential Grade Single Acting Spring Hinges

1502 Price Code 71

Size	Part Number	Finish	Price Each	Case Qty.	Box Qty.	Case Wgt.	Q S
3 1/2" x 3 1/2" 88.90 mm x 88.90 mm	155889	P	\$25.75	48	3		✓
	155880	3	\$33.75				✓
	155881	4	\$33.75				✓
	155882	10	\$33.75				✓
	155883	10A	\$33.75				✓
	155884	10B	\$40.75				✓
	155884E	10BE	\$33.75				✓
	155885	15	\$33.75				✓
	155886	26	\$33.75				✓
	155887	26D	\$25.75				✓
	155888	BSP	\$33.75				✓

1552 Price Code 71

Size	Part Number	Finish	Price Each	Case Qty.	Box Qty.	Case Wgt.	Q S
3 1/2" x 3 1/2" 88.90 mm x 88.90 mm	155890	32D	\$46.75	48	3		✓

2-Knuckle Architectural Hinges Price Code 20

Deco Tips FT, GT*, KT, LT*, RT are available on TA2731 in sizes 4" x 4", 4 1/2" x 4", 4 1/2" x 4 1/2", 5" x 4 1/2" and 5" x 5". If no part # is listed in the price book for the Deco Tip Hinge, add \$11.00 to the base hinge price.

*GT and LT tips not available in D4 and 10BE finishes.

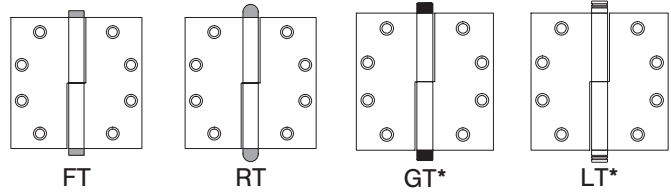

3-Knuckle Architectural Hinges Price Code 30

Deco Tips FT, GT*, KT, LT*, RT are available on TA314 and TA714 in sizes 4" x 4", 4 1/2" x 4", 4 1/2" x 4 1/2", 5" x 4 1/2" and 5" x 5". If no part # is listed in the price book for the Deco Tip Hinge, add \$11.00 to the base hinge price. Deco Tip FT is available on TA786 in sizes 4 1/2" x 4 1/2", 5" x 4 1/2" and 5" x 5".

*GT and LT tips not available in D4 and 10BE finishes.

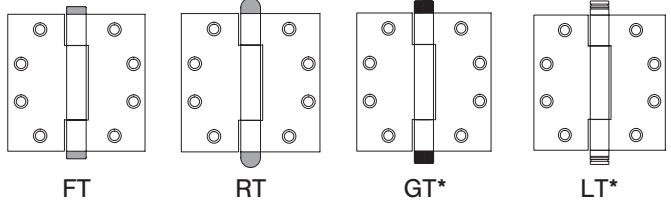

5-Knuckle Architectural Hinges Price Code 50

Deco Tips FT, GT*, KT, LT*, RT are available on TA2314 and TA2714 in sizes 4" x 4", 4 1/2" x 4", 4 1/2" x 4 1/2", 5" x 4 1/2" and 5" x 5". If no part # is listed in the price book for the Deco Tip Hinge, add \$11.00 to the base hinge price.

*GT and LT tips not available in D4 and 10BE finishes.

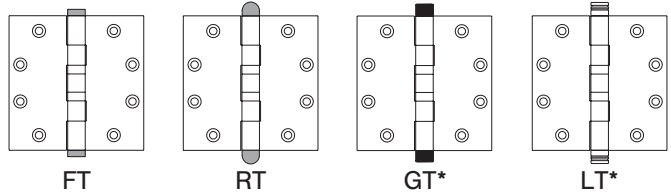

Concealed Hinges Price Code 20

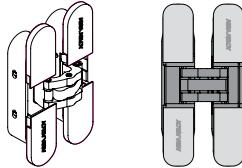

MK4001A

Size	Part Number	Finish	Price Each	Case Qty.	Box Qty.	Case Wgt.	Q S
4 1/2" x 7/8" 114.30 mm x 23 mm	MK67002	Satin Chrome	\$50.00	24	2	29.9	✓
	MK67003	Matte Black	\$50.00				✓

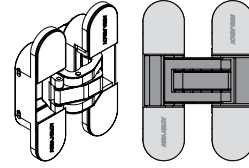

MK80A

Size	Part Number	Finish	Price Each	Case Qty.	Box Qty.	Case Wgt.	Q S
4 3/8" x 1 1/8" 111.5 mm x 29 mm	MK67006	Satin Chrome	\$70.00	16	2	13.2	✓
	MK67007	Matte Black	\$70.00				✓
	MK67017	White	\$70.00				

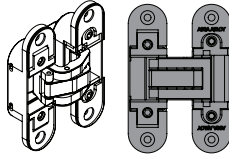

MK80

Size	Part Number	Finish	Price Each	Case Qty.	Box Qty.	Case Wgt.	Q S
4 3/8" x 1 1/8" 111.5 mm x 29 mm	MK67004	Satin Chrome	\$65.00	16	2	13.2	✓
	MK67005	Matte Black	\$65.00				✓

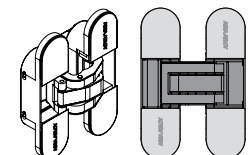

MK100

Size	Part Number	Finish	Price Each	Case Qty.	Box Qty.	Case Wgt.	Q S
6 1/4" x 1 1/8" 160 mm x 28 mm	MK67000	Satin Chrome	\$140.00	8	2	15.2	✓
	MK67001	Matte Black	\$140.00				✓
	MK67014	White	\$140.00				

MK80SS

Size	Part Number	Finish	Price Each	Case Qty.	Box Qty.	Case Wgt.	Q S
4 3/8" x 1 1/8" 111.5 mm x 29 mm	67016	32D	\$245.00	16	2	13.2	✓

MK150

Size	Part Number	Finish	Price Each	Case Qty.	Box Qty.	Case Wgt.	Q S
7 7/8" x 1 1/4" 200 mm x 32 mm	67018	Satin Chrome	\$175.00	16	2	13.2	

MK200

Size	Part Number	Finish	Price Each	Case Qty.	Box Qty.	Case Wgt.	Q S
10 1/4" x 1 3/8" 260 mm x 36 mm	67019	Satin Chrome	\$235.00	16	2	13.2	

Covers Price Code 15

Part No.	Description	Price	QS
67008	Cover For MK4001A Chrome Satin	\$5.00	✓
67009	Cover For MK4001A Black Matte	\$5.00	✓
67010	Cover For MK80A Chrome Satin	\$5.00	✓
67011	Cover For MK80A Black Matte	\$5.00	✓
67012	Cover For MK100 Chrome Satin	\$5.00	✓
67013	Cover For FOR MK100 Black Matte	\$5.00	✓

McKinney
ASSA ABLOY

Experience a safer
and more open world

800 346 7707 | www.mckinneyhinge.com
USA Prices Effective March 1, 2024

Copyright © 2024, ASSA ABLOY Accessories and Door Controls Group, Inc. All rights reserved. Reproduction in whole or in part without the express written permission of ASSA ABLOY Accessories and Door Controls Group, Inc. is prohibited.

Square Barrel Hinges

Price Code 20

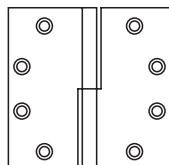

Hinges are handed, offered in special .177" weight only, and cannot be electrified. US4 is available as special order. Price same as US3.

Hinge Type	Hinge Size	Part Number		Hinge Finish	Book Price	Q S
		LH	RH			
SQ3331	4 1/2" x 4 1/2" 114.30 mm x 114.30 mm	75840	75841	3	\$73.00	✓
		75842	75843	10B	\$73.00	✓
		—	—	10BE or BSP	\$80.00	
		75844	75845	14	\$73.00	✓
		75742	75743	15	\$73.00	✓
		75846	75847	26	\$73.00	✓
		75744	75745	26D	\$65.00	✓

Square Barrel 3-Knuckle Hinges

Price Code 30

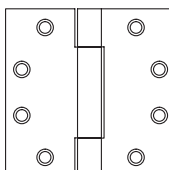

Hinges are non-handed, offered in special .177" weight stainless steel only and cannot be electrified.

Hinge Type	Hinge Size	Part Number	Hinge Finish	Book Price	Q S
SQ314	4 1/2" x 4" 114.30 mm x 101.60 mm	75850	32D	\$65.00	✓
	4 1/2" x 4 1/2" 114.30 mm x 114.30 mm	75851			✓

Olive Knuckle Hinges

Price Code 20

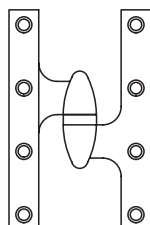

Hinges are handed, offered in standard weight only, and cannot be electrified.

Hinge Type	Hinge Size	Part Number		Hinge Finish	Book Price	Q S
		LH	RH			
TA3383	6" 152.40 mm x 152.40 mm	76204	76205	3	\$65.00	✓
		76204NL	76205NL	3NL	\$65.00	
		76206	76207	10B	\$72.00	✓
		76208	76209	14	\$65.00	✓
		76200	76201	15	\$65.00	✓
		76210	76211	26	\$65.00	✓
		76202	76203	26D	\$65.00	✓

McKinney

Complete Screw Packs

– Sales Code: 15, For Full Mortise Hinges, SS = Stainless, STL = Steel

For T2714, TA2714, T4A3786, 1502 Steel Based Hinges

Part#	Description	Price	Part#	Description	Price
MK07755	4 1/2 SS USP SCREW PACK	\$5.04	MK07766	4 1/2 STL D3 SCREW PACK	\$5.19
MK07756	4 1/2 STL 10B SCREW PACK	\$6.72	MK07767	4 1/2 STL D4 SCREW PACK	\$5.19
MK07757	4 1/2 STL 10 SCREW PACK	\$5.04	MK07769	4 1/2 SS US3 SCREW PACK	\$6.92
MK07758	4 1/2 SS 10B SCREW PACK	\$6.72	MK07770	4 1/2 SS US4 SCREW PACK	\$5.19
MK07759	4 1/2 STL USP SCREW PACK	\$5.04	MK07771	4 1/2 SS 10 SCREW PACK	\$5.19
MK07760	4 1/2 STL 26D SCREW PACK	\$5.04	MK07772	4 1/2 SS 26 SCREW PACK	\$6.92
MK07761	4 1/2 STL 10BE SCREW PACK	\$5.19	MK07773	4 1/2 SS D3 SCREW PACK	\$5.19
MK07762	4 1/2 STL US3 SCREW PACK	\$6.92	MK07774	4 1/2 SS D4 SCREW PACK	\$5.19
MK07763	4 1/2 STL US4 SCREW PACK	\$5.19			
MK07764	4 1/2 STL 15 SCREW PACK	\$5.19			
MK07765	4 1/2 STL 26 SCREW PACK	\$6.92			

For T2314, TA2314, T4A3386, 1552 Stainless Steel Based Hinges

Part#	Description	Price
MK07775	4 1/2 SS 32D SCREW PACK	\$6.92

For TA2772, T4A3782 Steel Based Hinges

Part#	Description	Price
MK07768	4 1/2 STL TA2772 26D SCREW PK.	\$6.30

Stainless Steel Torx Screw Pack (8/BAG)

Part#	Description	Price
MK22208	1/2 X12-24 FL TORX SS MS 32D – Machined Not Self Tapping	\$6.40
MK22209	1/2 X12-24 FL TORX SS MS 32D – Self Tapping	\$6.40
MK07545	12 X 1 1/4 FL TORX SS WS 32D – Self Tapping	\$8.48

Original Self-tapping Torx Screw part # MK22209 should be used on installation where installation requires self-tapping screw (some installations might have drilled holes other might require holes to be drilled).

New Machined Safety Torx Screw part # MK22208 should be used on installation where the door and frame are already drilled and tapped.

McKinney
ASSA ABLOY

Experience a safer
and more open world

800 346 7707 | www.mckinneyhinge.com
USA Prices Effective March 1, 2024

Copyright © 2024, ASSA ABLOY Accessories and Door Controls Group, Inc. All rights reserved. Reproduction in whole or in part without the express written permission of ASSA ABLOY Accessories and Door Controls Group, Inc. is prohibited.

The ASSA ABLOY Group is the global leader in access solutions.
Every day, we help billions of people experience a more open world.

ASSA ABLOY Opening Solutions leads the development within door openings and products for access solutions in homes, businesses and institutions. Our offering includes doors, frames, door and window hardware, mechanical and smart locks, access control and service.

McKinney[®]
ASSA ABLOY

McKinney
225 Episcopal Road
Berlin, CT 06037
www.mckinneyhinge.com
1 800 346 7707

McKinney is a product line of ASSA ABLOY Accessories and Door Controls Group, Inc., an ASSA ABLOY Group company.
Copyright © 2024 ASSA ABLOY Accessories and Door Controls Group, Inc. All rights reserved. Reproduction in whole or in part without the express written permission of ASSA ABLOY Accessories and Door Controls Group, Inc. is prohibited. Printed in the U.S.A.

5094I 3/24