

Price Book

Effective May 2024

Revised 5/9/24

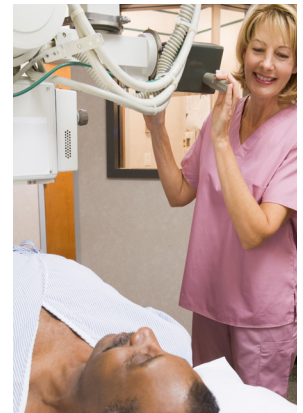
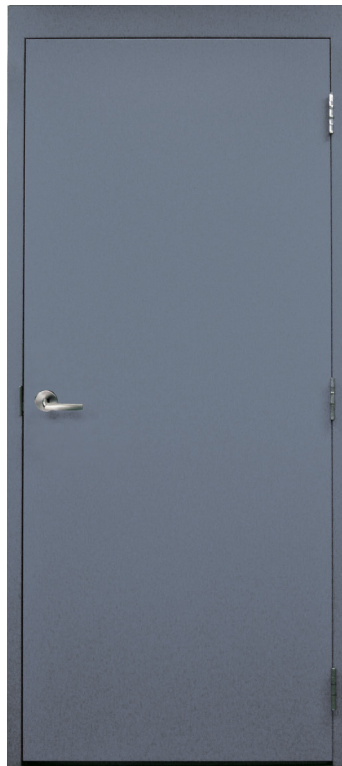

CUR-201-04/24

Experience a safer
and more open world

DESCRIPTION	PAGE(S)
Policies	1
Policies Continued	2
General Information	3
Doors	3
Frames	3
Component Parts for Frames	3
Door and Frame Order Conditions	3
Trademark Use Policy	4
Weights — Doors	5, 6
607S Series	5
707S Series	5
727S Series	5
737S Series	5
747S Series	6
757S Series	6
847S Series	6
857S Series	6
Factory Glazed Doors	7
Weights — KD Frames	8, 9
M Profile	8
C Profile	9
C-CM Profile	9
Weights — Frame Components	10, 11
M Profile	10
C Profile	11
C-CM Profile	11
Weights — CCW	12
Swift-Pac Doors and Frames	13

Notes
General Information

May, 2024



YOUR CURRIES DISTRIBUTOR MANUAL

You will find this manual an important source of information for CURRIES products. As new information is developed, or as changes occur, the new material will be mailed directly to you. If you will insert the new pages as received, your CURRIES Manual will always be current.

POLICIES

TERMS

CURRIES reserves the right to refuse purchase orders and is not bound to honor them unless they have been accepted at the Mason City, Iowa, home office. CURRIES reserves the right to sell or not to sell to a firm for any reason which in their sole discretion seems appropriate. Terms are 2% ten days and net 30 days from date of invoice.

PRICES

All prices are subject to change without notice and are not guaranteed.

QUOTATIONS

Quotations are based on market conditions and are subject to acceptance within the terms stated on the quote. Quotations are subject to revisions or cancellations should conditions warrant.

CHANGES OR CANCELLATIONS

From the time an order for manufactured products is received and through the coordination phase it may be changed or cancelled without charge.

Once the order has been scheduled for production it cannot be changed or cancelled, the product belongs to the customer. If requested, we will not ship the product, however, the customer will be invoiced the full amount for the material. A Quick Ship Order, due to the nature of the process cannot be changed or cancelled after it has been scheduled, which can be a matter of hours after we receive it.

MINIMUM INVOICE

Purchase orders amounting to less than \$50.00 net will be subject to an additional net charge of \$15.00 over and above the net order amount.

FREIGHT

All goods are shipped F.O.B. Point of Origin and become the customer's property when they pass into the hands of the transportation company. Prepay and add programs are available for LTL and truckload shipping from the factory locations.

- Distributor must remove and dispose of dunnage from Pool Truck. Dunnage cannot be put back onto trailer. If so, a \$300 fee will be charged to the Distributor.
- A \$75 per day minimum storage and handling fee will be assessed each time a request is received for Curries to temporarily store projects for a Distributor. *MUST BE FACTORY QUOTED.*

WARRANTY

We warrant our products against defects in workmanship and materials for a period of one year as follows:

- (a) There are no warranties, express or implied, which extend beyond those described herein, and there is no implied warranty or merchantability.
- (b) If our products should prove to be defective, our only responsibility will be to either repair or replace the defective item(s), and we will have no liability or obligation for any damages of any kind beyond such repair or replacement.
- (c) Our obligation to repair or replace any defective item terminates one year after the product has been delivered by us to the customer, and also terminates at any time anyone other than our company performs any work of repair, service or replacement on the item without our prior written consent.
- (d) We assume no liability to pay any costs of labor or material for repair, service or replacement of any CURRIES product which has been incurred by anyone other than us.
- (e) CURRIES is committed to providing the highest quality products and services to its customers as possible. Errors can occur on occasion. We request our distributors to act as "final" quality control on our hollow metal. A simple double check procedure by an assembly person prior to modifying a door or welding a frame should be performed on every unit of product that leaves a distributor's place of business. This simple action can prevent a considerable amount of potential field problems.

RETURNS

No goods may be returned without written approval from the home office in Mason City, Iowa. Replacement will be made only after a thorough investigation of the product is made, and investigation reveals that it is defective or was shipped in error. All returns must refer to the return authorization letter.

CLAIMS

Claims for price adjustments must be submitted in writing to the Mason City, Iowa, home office within 30 days from date of invoice in question. Claims for shortages or incorrectly filled orders must be made in writing within 10 days after receipt of shipment.

Policies (continued)

General Information

May, 2024



POOL SHIPPING

Freight shipments may be pool shipped together with other distributor orders to various regions of the country. Pool shipment program descriptions are available from the factory.

DELIVERY

Scheduled shipping dates are based on our best estimate, and are not guaranteed.

PENALTY CLAUSES

We will not accept purchase orders with a penalty or late delivery provision.

MISCELLANEOUS

The Curries Distributor Manual and price lists are the property of Curries and are issued subject to recall.

HARDWARE TEMPLATING

CURRIES strives to update our records for manufacturing products on a daily basis. We are constantly receiving template revisions and updates from the BHMA member hardware manufacturers and add this information to our files when received. We produce templated hardware preparations within ANSI guidelines and the manufacturer's recommendations. It is the Distributor's responsibility to provide templates to CURRIES when the manufacturer of a piece of hardware has not published templates or out of date hardware is being used.

CURRIES cannot be responsible for non-templated or out of date preparations without a physical sample of the hardware submitted to CURRIES.

HARDWARE LOCATIONS/OTHER MANUFACTURERS

CURRIES will manufacture products to other manufacturers' standard hardware locations and bottom undercuts (except undercut on 607 doors) according to the current issue of SDI 129 and our developed list of other manufacturers locations. When you specify another manufacturer's standard locations on the order form, these are the locations we will use for manufacturing. It is the Distributor's responsibility to ensure that these locations are the correct ones for the application. We do not receive notification from other manufacturers when they change their standard locations. Special caution is recommended when ordering material to fit existing doors or frames because manufacturers do change their standards. CURRIES will supply a copy of SDI 129 and our developed hardware locations list upon request. Contact the factory for hardware locations other than what CURRIES publishes as standard.

GLASS POCKET DIMENSIONS

CURRIES standard glazing pocket dimensions for doors and frames are detailed in our Technical Data Manual. Unless specified otherwise we will manufacture products in accordance with these details. We can manufacture many other variations and combinations based on detailed drawings which may be submitted to CURRIES prior to fabrication of products.

FINISH PAINT COMPATIBILITY

CURRIES uses modern, high quality prime paints that comply with many published industry standards. The primer we use is compatible with many of the finish paint systems used in the construction industry.

We do not, however, make any warranty as to the compatibility of our primer with any finish paint due to variations that can occur during application of the finish paint by the painter. Questions on compatibility of our prime paint with finish paint can be addressed by submitting manufacturers' specifications for the finish paint to CURRIES.

CODE SPECIFICATION COMPLIANCE

CURRIES maintains industry contacts to assure product compliance to national building code standards, ADA requirements, and fire protection codes. Our products can comply with most published fire standards, performance standards, and general construction standards when properly ordered from the factory. We can not be responsible for regional variations imposed by a local authority having jurisdiction or other interpretations of specifications that are unknown to us prior to furnishing materials to a job.

GALVANIZED PRODUCTS

Hot dipped zinc coated products, galvanized (A60) or galvanized (G90) are available with most CURRIES' products. Check with the factory for availability and lead time of obtaining G Class zinc coated products. We comply with SDI 112-97 and do not imply corrosion free products are available.

STORAGE AND EXPOSURE

CURRIES' prime paint complies with ANSI/SDI and other published industry standards for salt spray and humidity chamber testing. Proper storage of doors and frames in a warehouse or at a jobsite is essential to prevent corrosion before the finish paint is applied. They must be kept dry and protected from exposure to the elements. We recommend that the finish paint coat be applied soon after installation. CURRIES cannot be held responsible for corrosion that occurs on prime painted doors and frames either as a result of improper storage or from prolonged periods of exposure of installed components to conditions that introduce moisture on the product.

CURRIES Division of ASSA ABLOY Door Group, LLC

GENERAL INFORMATION - DOORS

Doors are individually wrapped and prime painted, with the exception of stainless steel doors (which are unpainted), and other doors as noted in this manual (which are not individually wrapped).

Doors over 4' wide and/or 8' high will be crated.

Non-label pairs of doors consist of two single doors with standard hardware preparations as listed. We recommend that an astragal be used with all pairs of doors with the exception of pairs with push-pull hardware.

Base prices of doors include standard hardware preparations.

See individual price lists and/or the special hardware preparations section for the cost of non-standard hardware preparations. Refer to the Engineered Door and Frame Section for special or engineered door preparations.

GENERAL INFORMATION - FRAMES

Standard frame profiles include Masonry (M), Masonry cased opening (MK), Masonry Double Egress (DEM), Drywall (C), Drywall cased opening (CK), and Drywall Masonry (CM). Available equal or unequal rabbet M, C, or CM or single rabbet G, CG, or CMG (standard profile limitations are detailed in Technical Data Manual). All standard frames are die mitered, knocked down, prime painted or as otherwise noted in the manual. Spreader bars are not included, standard jamb anchors and base anchors are included in frame base prices unless noted otherwise. Refer to Engineered Door & Frames section of this manual for special requirements. Non-Standard hardware requirements, refer to Special Hardware Preps section of this manual.

COMPONENT PARTS FOR FRAMES

(CCW — Custom Profiles — Stainless Steel)

Flush stick components available cut to length per job requirements.

Components are prime painted and assembled, ready for shop modification for frame fabrication. Standard and custom profiles available (see Technical Data Manual) for most assembly requirements.

Contact factory for limitations on custom profiles. Profiles that require filler plate attaching member members will be assembled with the exposed edge seam. Filled profile seams are available with welded frames only when indicated. Stainless steel components and assemblies available — see special pages pertaining to stainless steel. Frame members are fabricated from cold rolled or galvaneal steel (as specified) of either 12, 14, 16, or 18 gauge steel. Stainless steel is standard 304 #4 satin finish, 14 or 16 gauge (as specified).

FIRE LABEL PRODUCTS

CURRIES products comply with most current fire listing test criteria U.L. 10C.

DOOR AND FRAME ORDER CONDITIONS

Subject to the following requirements and exception:

1. Must be written up as one order on CURRIES Order Forms
2. Given one order number
3. Shipped to one destination
4. One Bill of Lading
5. Can be billed on one invoice
6. Type charge for "Prefinish-Paint Color" is never waived

Trademark Use Policy

General Information

May, 2024



Trademark Use Policy ASSA ABLOY Americas

The following policy ("Policy") of ASSA ABLOY Americas ("ASSA ABLOY"), and all of its affiliated group companies (collectively, the "Group Companies"), applies to the use of certain intellectual property of all such Group Companies, including all trademarks, names, logos, product images, and related information (the "ASSA ABLOY Marks"). ASSA ABLOY Marks are proprietary and critical to the success of ASSA ABLOY and the Group Companies, and may only be used in strict compliance with this Policy.

This Policy covers any person or entity reselling any product of any Group Company with the consent of such Group Company (each, and "Approved Reseller"). Each Approved Reseller has a non-exclusive right to use certain of the ASSA ABLOY Marks relating to any of the Group Companies for which it is an Approved Reseller, subject to the following conditions:

- (1) Approved Reseller's use of ASSA ABLOY Marks must be truthful, fair, and not misleading;
- (2) Approved Reseller's advertising must clearly indicate that it is advertising of the Approved Reseller, and is not advertising of ASSA ABLOY;
- (3) Approved Reseller may not use any ASSA ABLOY Marks as part of or in connection with a domain name;
- (4) Approved Reseller's advertising must not imply or suggest an association between the Approved Reseller and ASSA ABLOY other than that of buyer and seller;
- (5) Approved Reseller's use of ASSA ABLOY Marks must be a positive representation of ASSA ABLOY, the Group Companies, and their products;
- (6) Approved Reseller's trade name must be more predominant on Approved Reseller's advertising than the ASSA ABLOY Marks;
- (7) Approved Reseller's use of ASSA ABLOY Marks must include the trademark symbol ® or TM, as appropriate, along with the following trademark legend printed in legible text on the Web page or document containing ASSA ABLOY Marks: "[describe ASSA ABLOY Marks] are trademarks or registered trademarks of ASSA ABLOY, Inc. or one of its affiliates in the United States and other countries.";
- (8) Approved Reseller must not make modifications of any ASSA ABLOY Marks; and
- (9) Approved Reseller may use only ASSA ABLOY Marks associated with the Group Companies for which it is an Approved Reseller (e.g., and Approved Reseller that sells Group Company X products but not Group Company Y products may use Group Company X trademarks in connection with its sale of Group Company X products, but may not use Group Company Y trademarks).

ASSA ABLOY reserves the right to review Approved Reseller's usage of ASSA ABLOY Marks at any time and may:

- (a) require changes to the use of ASSA ABLOY Marks at any time in its sole discretion, which changes must be implemented within 30 days of written notice to Approved Reseller;
- (b) condition the use of ASSA ABLOY Marks on ASSA ABLOY's prior approval of such use, which approval may be withheld in its sole discretion;
- (c) revoke permission to use ASSA ABLOY Marks at any time for any or no reason upon 30 days prior written notice to Approved Reseller; and
- (d) revoke permission to use ASSA ABLOY Marks immediately upon notice to Approved Reseller in the event Approved Reseller is in violation of this Policy, or of any other agreement with ASSA ABLOY or any Group Company

Approved Reseller's right to use ASSA ABLOY Marks in no way conveys to Approved Reseller any proprietary or economic interest in any ASSA ABLOY Marks.

Use of ASSA ABLOY Marks in violation of this Policy may result in severe civil and criminal liabilities. ASSA ABLOY will vigorously enforce this Policy by seeking all appropriate legal remedies, including, but not limited to, pecuniary damages and injunctive relief.

For trademark questions please contact:

Trent Turner

Technical Marketing Manager
ASSA ABLOY Door Group

Phone: 731 686 4289

E-mail: trent.turner@assaabloy.com

607				DOORS	707			
20 F	18 F	16 F	14 F	GA TYPE	20 F	18 F	16 F	14 F
				SIZE				
63	80			2468	64	81	97	118
70	89			2868	71	90	109	132
78	98			3068	79	99	120	146
85	108			3468	86	109	132	160
92	117			3868	93	118	143	175
99	126			4068	100	127	155	189
66	84			2470	67	85	102	123
74	94			2870	75	95	114	138
81	103			3070	82	104	126	153
89	113			3470	90	114	138	168
96	123			3870	97	124	150	183
104	133			4070	105	134	162	198
93	118			3080	94	119	144	175
102	129			3480	103	130	157	192
109	140			3880	110	141	172	209
119	151			4080	120	152	185	226
727				DOORS	737			
20 F	18 F	16 F	14 F	GA TYPE	20 F	18 F	16 F	14 F
				SIZE			145	266
	111	127		2868			164	187
	125	144		3068			182	208
	139	160		3468			201	229
	154	177		3868			219	251
	168	193		4068			238	272
	182	210		2470			153	174
	116	133		2870			172	196
	131	151		3070			191	218
	146	168		3470			211	241
	161	185		3870			230	263
	176	203		4070			249	285
	191	220		3080			219	250
	166	192		3480			240	275
	185	213		3880			264	301
	204	234		4080			285	326
	222	256						

EXTRAS

		LBS
Astragals	Add	6
Closer Reinforcement	Add	6
Rim Panic Reinforcement	Add	6
Vertical Rod Reinforcement	Add	8
Push/Pull Reinforcement	Add	6
Top Cap Steel	Add	1.5
N or T Edge Weld	Add	1
FV or FNV	Deduct	2
HG	Deduct	12
FG	Deduct	24

Adds for factory glazing can be found on page 17 of General Information section

Weight based on average steel tolerances and and common sizes. Variations may occur up to 10%. ALL WEIGHTS ARE LISTED IN POUNDS

SPECIAL SIZE DOOR WEIGHTS

Can be determined by finding the weight per square foot of an existing weighted door (ex: 3070) and multiply that square foot weight by the number of square feet in the over size door.

EXAMPLE:

To calculate the weight of a 707S 16 gauge 4'6" x 10' door, take a 707S 3070 16 gauge door which is 21 square feet. Then divide the 21 square feet into the weight of the door (126 lbs.) to determine the pounds per square feet.

$$126 \div 21 = 6 \text{ lbs./sq. ft.}$$

Then calculate how many square feet in the over size door 4'6" x 10' (4.5 x 10 = 45 sq.ft.), then multiply 45 sq. ft. by 6 pounds/sq. ft. to determine the approximate weight.

$$45 \times 6 = 270 \text{ lbs.}$$

NOTE:

When determining the weight of other door series and gauge, calculate from the appropriate table. For example: 747S

14 gauge 4'6" x 10' door, take a 747S 3070

14 gauge door to find the lbs./sq. ft.

$$183 \div 21 = 8.71 \text{ lbs/sq. ft.}$$

Weights - Doors

General Information

May, 2024



747 & 777				DOORS	757			
20 F	18 F	16 F	14 F	GA TYPE	20 F	18 F	16 F	14 F
				SIZE				
	99	115	136	2468				136
	118	136	160	2868				160
	127	148	173	3068				173
	146	169	197	3468				197
	155	180	212	3868				212
	174	201	235	4068				235
	104	121	142	2470				142
	124	143	167	2870				167
	133	155	182	3070				182
	153	177	207	3470				207
	163	189	222	3870				222
	183	211	247	4070				247
	152	177	208	3080				208
	175	202	237	3480				237
	186	216	254	3880				254
	208	241	282	4080				282
847				DOORS	857			
20 F	18 F	16 F	14 F	GA TYPE	20 F	18 F	16 F	14 F
				SIZE				
			151	2468				196
			172	2868				223
			194	3068				252
			216	3468				280
			237	3868				308
			258	4068				336
			159	2470				206
			181	2870				235
			203	3070				264
			226	3470				294
			248	3870				323
			271	4070				352
			232	3080				302
			258	3480				336
			284	3880				370
			310	4080				403

EXTRAS

		LBS
Astragals	Add	6
Closer Reinforcement	Add	6
Rim Panic Reinforcement	Add	6
Vertical Rod Reinforcement	Add	8
Push/Pull Reinforcement	Add	6
Top Cap Steel	Add	1.5
N or T Edge Weld	Add	1
FV or FNV	Deduct	2
HG	Deduct	12
FG	Deduct	24

Adds for factory glazing can be found on page 17 of General Information section.

Weight based on average steel tolerances and and common sizes. Variations may occur up to 10%. ALL WEIGHTS ARE LISTED IN POUNDS.

SPECIAL SIZE DOOR WEIGHTS

Can be determined by finding the weight per square foot of an existing weighted door (ex: 3070) and multiply that square foot weight by the number of square feet in the over size door.

EXAMPLE:

To calculate the weight of a 707S 16 gauge 4'6" x 10' door, take a 707S 3070 16 gauge door which is 21 square feet. Then divide the 21 square feet into the weight of the door (126 lbs.) to determine the pounds per square feet.

$$126 \div 21 = 6 \text{ lbs./sq. ft.}$$

Then calculate how many square feet in the over size door 4'6" x 10' (4.5 x 10 = 45 sq.ft.), then multiply 45 sq. ft. by 6 pounds/sq. ft. to determine the approximate weight.

$$45 \times 6 = 270 \text{ lbs.}$$

NOTE:

When determining the weight of other door series and gauge, calculate from the appropriate table. For example: 747S

14 gauge 4'6" x 10' door, take a 747S 3070 14 gauge door to find the lbs./sq. ft.

$$183 \div 21 = 8.71 \text{ lbs/sq. ft.}$$

Weights - Factory Glazed Doors General Information

May, 2024

Add per door for factory installed windows. Deduct for steel is already included in calculations.

All weights are in pounds (lbs).

	.25" TEMPERED	.25" FILMED WIRE	KERALITE FILMED 3/16"	KERALITE LAMINATED 5/16"	.625" IGU	1" IGU
FV	2	3	2	3	3	6
FV1	3	4	2	4	4	9
FNV	2	3	2	3	3	6
FNV1	6	7	4	7	7	14
FNV2	8	9	6	10	9	18
FNV3	9	10	7	11	11	21
FNV4	2	2	1	3	3	6
FNV5	2	3	2	3	3	7
FNV6	2	2	1	3	2	5
FNV7	4	4	3	5	4	9
FNV8	5	5	3	6	6	11
FNV9	2	3	2	3	3	7
HG	8	20	4	13	11	30
FG	14	19	6	24	21	58

Weights -KD Frames
General Information



May, 2024

M						PROFILE	M					
18 GAUGE						SIZE	16 GAUGE					
4-3/4	5-3/4	6-3/4	8-3/4	10-3/4	12-3/4		4-3/4	5-3/4	6-3/4	8-3/4	10-3/4	12-3/4
33	36	39	45	51	55	3068	41	44	48	55	63	67
35	38	41	47	54	58	4068	43	47	51	58	66	71
41	45	48	55	62	66	6068	50	54	58	67	76	81
45	49	52	60	67	72	8068	54	59	64	73	82	88
34	38	41	47	53	57	3070	42	46	50	57	65	70
36	39	43	49	56	60	4070	44	48	52	60	68	73
42	46	49	57	64	68	6070	51	56	60	69	78	84
46	50	54	61	69	74	8070	56	60	65	75	85	91
39	42	46	52	59	64	3080	48	52	56	64	73	78
41	44	48	55	62	67	4080	50	54	58	67	76	82
48	52	56	63	71	76	6080	58	62	67	77	87	93
51	56	60	68	77	82	8080	62	67	72	83	93	100
46	50	54	62	70	75	30100	56	61	66	76	86	93
48	52	56	64	73	78	40100	58	63	69	79	90	96
55	59	64	73	82	88	60100	66	72	77	89	100	108
58	63	68	78	87	94	80100	70	76	83	95	107	115

M						PROFILE	M					
14 GAUGE						SIZE	12 GAUGE					
4-3/4	5-3/4	6-3/4	8-3/4	10-3/4	12-3/4		4-3/4	5-3/4	6-3/4	8-3/4	10-3/4	12-3/4
51	56	60	65	69	79	3068	68	75	81	94	106	114
54	59	63	68	73	83	4068	72	79	85	99	112	121
62	67	73	84	95	101	6068	82	90	97	112	127	136
67	73	79	91	103	111	8068	90	98	106	123	139	149
53	58	62	72	82	88	3070	71	78	84	97	110	119
55	61	66	76	86	92	4070	75	82	88	102	116	125
64	69	75	86	97	104	6070	85	93	100	116	131	141
69	75	81	94	106	114	8070	92	101	109	126	143	154
59	65	70	81	91	98	3080	80	87	94	109	123	133
62	68	73	84	96	103	4080	83	91	99	114	129	139
71	77	83	96	108	116	6080	95	103	111	128	145	156
77	83	90	103	117	125	8080	102	111	120	139	157	168
70	77	83	96	109	117	30100	95	103	115	130	147	158
73	80	86	100	113	122	40100	98	107	116	135	153	165
82	89	97	111	125	135	60100	110	119	129	149	169	181
88	95	103	119	134	144	80100	117	128	138	160	181	194

Curriseal Frame WM Add 2 pounds Flat Plate Closer Add 1 Pound

NOTE: The weights shown may vary due to gauge tolerance.

C							C-CM						
18 GAUGE						PROFILE	16 GAUGE						
4-3/4	5-3/4	6-3/4	8-3/4	10-3/4	12-3/4	SIZE	4-3/4	5-3/4	6-3/4	8-3/4	10-3/4	12-3/4	
36	39	42	48	53	57	3068	44	48	51	58	65	70	
38	41	44	50	56	60	4068	46	50	54	61	69	73	
44	48	51	58	64	69	6068	54	58	62	70	78	84	
48	52	55	63	70	75	8068	58	63	67	76	85	91	
38	41	43	49	55	59	3070	46	49	53	60	68	72	
39	42	46	52	58	62	4070	48	52	56	63	71	76	
46	49	53	59	66	71	6070	55	59	64	72	81	86	
49	53	57	64	72	77	8070	60	64	69	78	88	94	
42	46	51	55	62	66	3080	51	55	59	67	76	81	
44	47	53	58	65	69	4080	53	58	62	71	78	84	
51	55	61	66	74	79	6080	62	66	71	80	90	96	
55	59	65	71	80	85	8080	66	71	76	87	97	103	
50	53	57	65	73	78	30100	60	65	70	80	90	96	
52	55	59	68	76	81	40100	62	68	73	83	93	100	
58	63	67	76	85	91	60100	71	76	82	93	104	111	
62	67	72	81	91	97	80100	75	81	87	99	111	118	

C-CM						PROFILE						
14 GAUGE						SIZE	4-3/4	5-3/4	6-3/4	8-3/4	10-3/4	12-3/4
56	59	65	75	81	88	3068						
59	63	69	79	86	93	4068						
69	73	79	90	99	105	6068						
74	79	86	98	108	115	8068						
59	61	68	78	86	91	3070						
61	65	71	81	91	96	4070						
71	75	81	93	104	108	6070						
76	81	89	100	113	118	8070						
65	70	75	86	95	101	3080						
68	74	79	90	100	106	4080						
79	85	89	103	114	120	6080						
84	91	96	110	123	130	8080						
76	83	89	101	113	121	30100						
79	86	93	105	118	126	40100						
89	98	104	118	131	140	60100						
94	104	111	125	140	150	80100						

Curriseal Frame

WM

Add 2 pounds

Flat Plate Closer

Add

1

Pound

NOTE: The weights shown may vary due to gauge tolerance.

Weights - Frame Components

General Information

May, 2024



M						PROFILE	M					
18 GAUGE							16 GAUGE					
4-3/4	5-3/4	6-3/4	8-3/4	10-3/4	12-3/4	SIZE	4-3/4	5-3/4	6-3/4	8-3/4	10-3/4	12-3/4
						STRIKE						
						JAMBS						
13	14	15	17	20	21	68	16	17	19	22	25	26
13	15	16	18	21	22	70	16	18	19	23	26	28
15	16	18	21	24	25	80	19	20	22	26	29	31
18	20	22	25	29	31	100	23	25	27	31	36	39
						HINGE JAMBS						
15	17	18	20	23	24	68	18	20	21	24	27	29
16	17	18	21	23	25	70	19	21	22	25	28	30
19	20	22	24	27	29	80	22	24	26	29	33	35
22	24	26	29	33	35	100	26	29	31	35	40	42
						HEADS						
6	7	7	8	9	10	30	7	8	9	10	10	11
7	8	9	10	12	13	40	9	10	11	13	15	16
11	12	13	15	18	18	60	14	15	16	19	22	23
14	16	17	20	22	24	80	18	20	22	25	28	31

M						PROFILE	M					
14 GAUGE							12 GAUGE					
4-3/4	5-3/4	6-3/4	8-3/4	10-3/4	12-3/4	SIZE	4-3/4	5-3/4	6-3/4	8-3/4	10-3/4	12-3/4
						STRIKE						
						JAMBS						
20	22	23	27	31	33	68	27	29	32	37	42	45
21	23	25	29	32	35	70	28	31	33	39	44	48
23	26	28	32	37	40	80	32	35	38	44	50	54
29	32	34	40	45	49	100	39	43	47	54	62	67
						HINGE JAMBS						
22	24	26	30	34	36	68	29	32	35	40	45	48
23	25	27	31	35	38	70	31	33	36	41	47	50
27	29	32	36	41	43	80	36	39	42	48	54	58
33	35	38	43	49	53	100	43	47	51	58	66	71
						HEADS						
9	10	11	13	15	16	30	13	14	15	18	20	22
12	13	15	17	19	21	40	17	18	20	23	26	28
18	19	21	25	28	30	60	24	27	29	34	38	41
23	26	28	32	37	39	80	32	35	38	44	50	54

Flat Plate Closer Reinforcement Add 1 pound

NOTE: The weights shown may vary due to gauge tolerance.

Weights - Frame Components General Information

May, 2024

C						PROFILE	C-CM					
18 GAUGE						SIZE	16 GAUGE					
4-3/4	5-3/4	6-3/4	8-3/4	10-3/4	12-3/4		4-3/4	5-3/4	6-3/4	8-3/4	10-3/4	12-3/4
						STRIKE JAMBS						
14	15	16	18	20	22	68	17	18	20	23	25	27
15	16	17	19	22	23	70	18	19	21	24	27	29
16	18	20	22	25	26	80	20	22	24	27	30	32
21	22	23	27	30	32	100	25	27	29	33	37	40
						HINGE JAMBS						
16	17	18	19	24	25	68	20	21	23	26	28	30
17	19	20	22	25	26	70	21	22	24	27	30	31
20	22	24	26	28	30	80	24	26	27	31	34	36
24	25	27	31	34	36	100	28	31	33	37	41	44
						HEADS						
6	7	8	9	10	11	30	8	8	9	11	12	13
8	9	10	11	13	13	40	10	11	12	14	16	17
12	13	14	16	18	20	60	15	16	17	20	23	24
15	17	18	21	24	26	80	19	21	23	26	30	32

C-CM						PROFILE	C-CM					
14 GAUGE						SIZE	16 GAUGE					
4-3/4	5-3/4	6-3/4	8-3/4	10-3/4	12-3/4		4-3/4	5-3/4	6-3/4	8-3/4	10-3/4	12-3/4
						STRIKE JAMBS						
21	23	25	29	31	34	68						
23	24	26	30	34	36	70						
25	28	30	34	38	40	80						
31	34	36	41	46	50	100						
						HINGE JAMBS						
25	26	29	33	35	38	68						
26	28	30	34	38	39	70						
30	33	34	39	43	45	80						
35	39	41	46	51	55	100						
						HEADS						
10	10	11	14	15	16	30						
13	14	15	18	20	21	40						
19	20	21	25	29	30	60						
24	26	29	33	38	40	80						

Flat Plate Closer Reinforcement Add 1 pound

NOTE: The weights shown may vary due to gauge tolerance.

Weights -CCW 10'6" Length, 16 and 14 Gauge

General Information



ASSA ABLOY

May, 2024

JAMB DEPTH GAUGE	4-3/4"		5-3/4"		6-3/4"		8-3/4"		10-3/4"		12-3/4"	
	16	14	16	14	16	14	16	14	16	14	16	14
CCW NUMBERS												
21	22	28	25	30	27	34	32	39	36	44	39	48
23	32	39	34	42	36	44	40	50	44	56	47	59
115	38	47	40	50	43	53	48	60	53	67	57	71
117	45	56	48	60	51	64	57	73	64	80	68	85
40	20	25	22	28	25	30	29	37	34	42	36	45
20	24	30	26	34	30	37	35	44	40	50	43	54
26	23	28	25	32	27	35	33	40	37	45	40	49
24, 25, 39	26	32	28	35	30	37	35	43	40	48	42	51
62, 63, 119, 120	27	33	29	35	32	38	36	44	41	49	43	53
16	42	53	46	58	50	63	60	75	68	85	72	91
17	50	63	56	69	60	75	68	85	77	97	82	102
18	60	76	67	83	72	89	82	102	92	116	98	122
50	71	88	78	97	84	104	96	119	107	135	115	143
41	42	53	47	59	51	64	60	75	68	86	74	91
42, 43, 44	45	56	49	61	54	67	63	78	71	88	76	95
81, 82, 133, 134	46	57	50	62	55	68	64	79	72	89	77	96
45, 46, 47	45	56	49	61	54	67	63	78	71	88	76	95
83, 84, 135, 136	46	57	50	62	55	68	64	79	72	89	77	96
85	43	54	47	59	51	64	60	75	69	86	74	91
86, 87, 88	48	59	53	64	57	69	66	81	75	91	79	97
89, 90, 137, 138	50	61	55	66	59	71	68	83	77	93	81	99
19	11	13	13	16	15	19	19	24	23	29	26	33
27	9.5	13	13	15	15	18	19	23	23	28	26	33
22	13	15	15	18	17	21	21	26	25	32	28	35
29	15	19	17	21	19	24	23	29	28	35	30	38
91	14	18	16	20	18	23	23	28	27	34	29	38
92	16	20	18	23	21	25	25	32	29	37	33	40
28	36	44	40	50	44	56	54	66	62	78	67	83
139	43	54	47	58	51	62	61	71	69	80	75	85
140	50	64	55	68	59	72	68	82	77	90	82	96
55	48	60	53	65	57	70	65	82	75	92	79	99
48, 49	NA	NA	NA	NA	NA	NA	NA	NA	NA	NA	NA	NA
51, 52	55	68	64	80	72	90	90	112	107	134	117	146
53, 54	57	71	66	82	75	93	92	116	109	138	119	149

12 Gauge Add 40% to 14 Gauge Weight

NOTE: The weights shown may vary due to gauge tolerance

"Swift Pac" DOORS AND FRAMES

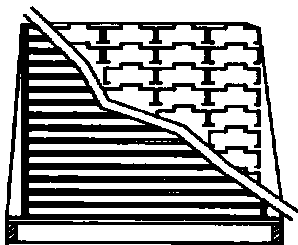

DESCRIPTION:
 CURRIES' "Swift-Pac" Door and Frame Program offers the most popular sizes and face steel gauges required in today's construction market nationwide. "Swift-Pac" Doors and Frames include an additional 5% net savings to you.

DOORS:

Palletized units are packaged with 15 identical products. Units cannot be broken apart for mixed gauge, size, hand, etc. These products can be ordered as a Service Center item or from the personalized preprinted stock order form two week manufacturing program.

607S AND 707S SERIES OFFERING

- 20 gauge non handed **with** and **without** closer reinforcements, 3068 and 3070 *
- 18 gauge non handed **with** and **without** closer reinforcements, 3068 and 3070 *

707S SERIES OFFERING

- 20 gauge handed **without** closer reinforcements, 3068 and 3070 *
- 18 gauge handed **with** and **without** closer reinforcements, 3068 and 3070 *
- *Standard Hinge Preparations
- 18 gauge non-handed **with** closer reinforcements, 3068 & 3070 *

LOCK OPTIONS:

Cylindrical Lock (G2), Lever (G2B)
 Mortise Lock Edge only (G3AEO)
 Mortise Lock Reinforce only (G3ARO)
 (See the last page of the "Door" section in this Price Manual)

FRAMES:

Palletized units are packaged with identical products per unit. Identified Swift-Pac items are shown on the last page of the "Frame" section in this Price Manual. Units **cannot** be broken apart for mixed hand, size, quantity, etc. These products can be ordered as a Service Center item or from the personalized preprinted stock order form two week manufacturing program. "SWIFT - PAC" frames are available in Masonry "M" and Drywall "C" profile frames in 16 gauge and in the following shipping unit quantities:

JAMB/HEAD OFFERING

Jamb Depths:	5-3/4"
Profile:	M Series
Unit Quantities:	52 jambs per unit 52 or 26 heads per unit
Jamb Depths:	5-5/8"
Profile:	C Series
Unit Quantities:	52 jambs per unit 52 or 26 heads per unit
Jamb Depths:	5-7/8"
Profile:	C Series
Unit Quantities:	52 jambs per unit 52 or 26 heads per unit

NOTE: Palletizing unit quantities is critical for maximum efficiencies in storage and shipping these unit packages.



DESCRIPTION	GAUGE	PAGE(S)
607S Series — Commercial Grade	20,18	
Standard Description		2
Extras		3
707S Series — Commercial Grade	20, 18, 16, 14	
Standard Description		4
Extras		5
707S Series — Embossed Panel	18	
Standard Description		6
Extras		7
707S 1 or 2-Panel High Definition Embossed	18	8
CURRIStain		
707 6 Panel		9
707 Polystyrene Core		10-11
727 Temperature Rise		12-13
727S Series — Temperature Rise Doors	18,16	
Standard Description		14
Extras		15
747S Series — Steel Stiffened Doors	18,16,14	
Standard Description		16
Extras		17
747S-TR Series — Steel Stiffened Temperature Rise Doors		
Standard Description	18, 16	18
Extras		19
767S Series — Stile and Rail Door		20
777S Trio Series — Steel Stiffened —Fiberglass Filled	18, 16, 14	
Standard Description		22
Extras		23
777SE Trio-E Series — Steel Stiffened —Polyurethane Filled	18, 16	
Standard Description		24
Extras		25
847S Series — Security 1 3/4" thick doors	14	
Standard Description		26
Extras		27
857S Series — Security 2" thick doors	14	
Standard Description		28
Extras		29
757 Series (STC) Doors		
Standard Description		30
Extras		31

607S Series Doors - Polystyrene Core Flush Door Prices

May, 2024



WIDTH	HEIGHT	20 GA	18 ga		
20, 24, 26, 28 .210, 30	68	\$593	\$667		
34, 36	68	\$769	\$852		
38, 310, 40	68	\$888	\$950		
20, 24, 26, 28 .210, 30	70	\$612	\$708		
34, 36	70	\$801	\$887		
38, 310, 40	70	\$910	\$999		
20, 24, 26, 28 .210, 30	72	\$676	\$797		
34, 36	72	\$856	\$961		
38, 310, 40	72	\$962	\$1,061		
30	80	\$774	\$889		
34, 36	80	\$1,070	\$1,096		
38, 310, 40	80	\$1,073	\$1,187		

STANDARD DESCRIPTION

Cold rolled steel 20 or 18 gauge Polystyrene core, exposed seam "S" edge only . 1 3/4" thick doors. Limited hardware preparations

EDGE BEVELS AVAILABLE "B" square both edges/non handed — No Charge

OPTIONS

Galvanneal steel (A60) – Not available

Visual ID tag Add \$6

LISTED FIRE LABEL DOORS

Label door restrictions per gauge and size can be determined in the current CURRIES product brochure . Prices are without closer (CL).

OVERSIZED DOOR OPTIONS – Not Available

			LESS
			CL
Underwriters Laboratories	ABCG	Add	\$65
Warnock Hersey	ABCG	Add	\$17
20 minute U .L . or W .H .I .		Add	\$17
Label construction		Add	\$24

NON STANDARD SIZE DOORS – Not available

(Standard sizes are published on this page)

EXTRAS

ASTRAGALS

Astragals must be ordered separately, loose from parts section

CAPS — top or bottom

Steel installed flush (with screws per cap) Add \$26

CLOSER

Surface mounted, reinforcement only Add \$36

FLUSH BOLTS OR SURFACE BOLTS

Top and bottom flush bolt ANSI A115.4 H1 Add \$87

Edge prep . - hole only for use with

Z astragal with H1 prep . H1 HO Standard

Top and bottom surface bolt SB Add \$61

reinforcement only

HINGE PREPARATIONS

4 1/2" (non handed) Standard

LOCK PREPARATIONS

Cylindrical lock - 161 G2 Standard

Cylindrical lock - lever trim holes G2B Standard

(Universal lever trim prep .)

Deadlock - tubular 181 G16 Standard

Preparations for 607 series doors are limited to the published preparations on pages 2 and 3 .

EXTRAS

LOCK PREPARATIONS CONTINUED

Mortise lock - Escutcheon Trim G3 Standard

Mortise lock edge only preparation G3AEO Standard

Mortise lock reinforce only G3ARO Standard

Rim panic reinforce only G11 Add \$46

Rim vertical rod reinforce only G11A Add \$87

Push Pull G18 Add \$46

LOUVERS

Preparation or installation is not available in the 607 series from the factory .

STRIKES

4 7/8" ANSI strike E1 NL Add \$63

Strike preps in non handed doors must have lip cut into door edge by others .

4 7/8" strike hole only for use with Z astragal E1HO

Standard with E1 prep

UNDERCUTS

5/8" standard, 3/8" and 3/4" available

VISION KITS

Preparation or installation is not available in the 607 series from the factory .

Preprinted manufactured order forms are available in the CURRIES Partner Area of the website

4
707 Series Doors - Polystyrene Core
Flush Door Prices

May, 2024



WIDTH	HEIGHT	20 GA	18 GA	16 GA	14 GA
20, 24, 26, 28, 210, 30	68	\$684	\$757	\$880	\$1,156
34, 36	68	\$872	\$953	\$1,078	\$1,355
38, 310, 40	68	\$1,002	\$1,062	\$1,186	\$1,461
20, 24, 26, 28, 210, 30	70	\$688	\$782	\$914	\$1,210
34, 36	70	\$896	\$980	\$1,111	\$1,398
38, 310, 40	70	\$1,016	\$1,103	\$1,232	\$1,519
20, 24, 26, 28, 210, 30	72	\$756	\$873	\$1,016	\$1,333
34, 36	72	\$953	\$1,056	\$1,196	\$1,514
38, 310, 40	72	\$1,069	\$1,166	\$1,308	\$1,624
30	80	\$928	\$1,040	\$1,185	\$1,505
34, 36	80	\$1,148	\$1,203	\$1,346	\$1,673
38, 310, 40	80	\$1,191	\$1,303	\$1,445	\$1,770
30	90	N/A	\$1,622	\$1,780	\$2,138
34, 36	90	N/A	\$1,800	\$1,959	\$2,314
38, 310, 40	90	N/A	\$1,882	\$2,040	\$2,397
30	100	N/A	\$1,975	\$2,146	\$2,538
34, 36	100	N/A	\$2,154	\$2,323	\$2,708
38, 310, 40	100	N/A	\$2,236	\$2,405	\$2,788

OVERSIZED DOOR OPTIONS

Doors over 4' wide and 8' high are factory crated for protection in transit
 20 gauge doors are **not available**

Doors over 4' wide are to be priced as follows:

- 16 gauge CR Steel max size 5'x10' add to 40 x 100 price \$727
- 16 gauge A6 Steel max size 4' 10"x10' add to 40 x 100 price \$727
- 14 gauge CR Steel max size 5'x10' add to 40 x 100 price \$727
- 14 gauge A6 Steel max size 4'10"x10' add to 40 x 100 price \$727

Larger door sizes are available in 747 series only
 Contact Factory for quote

NON STANDARD SIZE DOORS

Price as the next largest standard size door

STANDARD DESCRIPTION

Polystyrene core with an "A" edge bevel and exposed seam "S" edge are standard
 1 3/4" thick doors

EDGE BEVELS AVAILABLE

- "A" standard (1/8" in 2" lock edge-square hinge edge) No Add
- "B" specify (square both edges) No Add
- "G" specify (1/8" in 2" bevel both edges) Add \$18

NOTE: For other edge bevels refer to Engineered Door Section

Galvanneal Steel (A40 & A60)

- | | | A40 | A60 |
|---------------|-----|------------|------------|
| a) 68 HEIGHT | Add | \$48 | \$97 |
| b) 70 HEIGHT | Add | \$48 | \$103 |
| c) 72 HEIGHT | Add | \$48 | \$111 |
| d) 80 HEIGHT | Add | \$48 | \$118 |
| e) 90 HEIGHT | Add | \$56 | \$124 |
| f) 100 HEIGHT | Add | \$56 | \$131 |

Note: 20 gauge galvanneal over 30 wide - not available

Galvanized (G90) includes epoxy primer

- | | | |
|---------------|-----|-------|
| a) 68 HEIGHT | Add | \$354 |
| b) 70 HEIGHT | Add | \$361 |
| c) 72 HEIGHT | Add | \$367 |
| d) 80 HEIGHT | Add | \$373 |
| e) 90 HEIGHT | Add | \$382 |
| f) 100 HEIGHT | Add | \$395 |

Honeycomb core construction

Add \$44

QMAX thermally enhanced core

Add \$148

"N" seamless edge filled

Add \$89

"T" Continuous wire welded

Add \$143

12 Gauge Hinge Rail

No Add

Visual ID tag

Add \$6

LESS

LISTED FIRE LABEL DOORS (Prices are without closer CL):

- | | | | CL |
|----------------------------------|------|-----|------|
| Underwriters Laboratories | ABCG | Add | \$65 |
| Warnock Hersey | ABCG | Add | \$17 |
| 20 minute U . L . or W . H . I . | | Add | \$17 |
| Label construction | | Add | \$24 |

EXTRAS

ASTRAGALS

Z type blank screw applied	Z1	Add	\$96
Z type with strike E1 screw applied	Z1/E1	Add	\$159
Z type with strike and flush bolt screw applied	Z1/E1/H1	Add	\$246
Flat astragal screw applied		Add	\$88

CAPS — top or bottom

Steel installed flush (with screws per cap)		Add	\$26
---	--	-----	------

CLOSER

Surface mounted, reinforcement only		Add	\$36
Concealed or semi-concealed		Add	\$313

DUTCH DOOR (SHELF EXTRA)

	Add	\$358
--	-----	-------

FLUSH BOLTS OR SURFACE BOLTS

Top and bottom flush bolt ANSI A115.4 (when used without astragal or with flat bar astragal)	H1	Add	\$87
Top and bottom surface bolt reinforced only	SB	Add	\$61

HINGE PREPARATIONS

4 1/2" standard or heavyweight		Standard	
5" Hinge standard or heavyweight		Add Each	\$9
1 1/2 pair up to and including 7'6"		Standard	
2 pair over 7'6" to 10'0"		Standard	
Anchor hinge set (e.g. McKinney TA792) No drill, no tap (e.g. McKinney TA793)		Add	\$203
		No Add	
Continuous hinge preparation (mounting holes field drilled)			
Concealed mounting (e.g. McKinney 11, 24)		No Add	
12 gauge hinge rail available (Specify)		No Add	
Surface mounting (e.g. McKinney 21, 53)		Add	\$108

LOCK PREPARATIONS

Cylindrical lock - 161	G2	Standard	
Cylindrical lock - lever trim holes (Universal lever trim prep.)	G2B*	Standard	
Deadlock - tubular 181	G16	Standard	
Deadlock - mortise 190 (e.g. Sargent 4870)	G17	Add	\$87
Interconnected lock	G25	Add	\$58

EXTRAS

LOCK PREPARATIONS CONTINUED

Mortise lock - Escutcheon Trim	G3	Standard	
Mortise lock - Sectional Trim	G3A*	Standard	
Hotel and master ring cylinder	**G3A	Standard	
Mortise lock edge only preparation	G3AEO	Standard	
Mortise lock reinforce only	G3ARO	Standard	
Mortise panic exit	G12*	Add	\$87
Rim panic reinforce only	G11	Add	\$46
Rim panic reinforce with function holes	G11*	Add	\$46
Rim vertical rod reinforce only	G11A	Add	\$87
Rim vertical rod with function holes	G11A*	Add	\$87
Concealed vertical rods	G12A*	Add	\$578
Low profile vertical rod	G12B	Add	\$578
Recessed vertical rod	G13C	Add	\$578
Mortise panic ctr & bottom latch	G14C	Add	\$141
Label Fire Pin (if required)		Add	\$30

LOUVERS

Louver cutout only		Add	\$81
Louver cutout surround with channel (label louver requirement)		Add	\$142

Replacement Door

3 Hinge preps		Add	\$31
4 Hinge preps		Add	\$42

STRIKES

4 7/8" ANSI lipped strike	E1	Add	\$63
2 3/4" ANSI lipped strike	E2	Add	\$63
3 1/2" ANSI deadlock strike	E3	Add	\$63
2 3/4" ANSI deadlock strike	E4	Add	\$63
Electric Strike	E9*	Add	\$143
Electric raceway		Add	\$166
Open back strike	*	Add	\$143

*Advise of manufacturer and function of hardware

UNDERCUTS

5/8" standard, 3/8", 3/4" available		No Add	
All other undercuts per door		Add	\$24

VISION KITS-Type 9 Standard or Optional Type 1

Vision kits installed (3/8" pocket) standard rim type kit			
FV		Add	\$228
FNV		Add	\$255
HG		Add	\$298
FG		Add	\$420
FL cutout only		Add	\$81

NOTE: For additional window options refer to the Engineered Door Section

SWIFT PAC

Preprinted manufactured order forms are available in the CURRIES Partner Area of the website.

707S Embossed Panel 18-16 Flush Door Prices

May, 2024



W	H	E6	E62FNVS	E6HGS
		18 CRS	18 CRS	18 CRS
28, 210, 30	68	\$989	\$1,707	\$1,348
28, 210, 30	70	\$1,014	\$1,732	\$1,373

STANDARD DESCRIPTION

Cold rolled Steel (CRS) 18 gauge steel Galvanneal steel 18 or 16 gauge steel. Polystyrene core with a "B" edge bevel "S" exposed edge seam.
1 3/4" thick doors only

Type 9 kit included on doors with lites
See Engineered Door Section for other options

EDGE BEVELS AVAILABLE

- "A" No Add
- 1/8" in 2" lock edge-square hinge edge No Add
- "B" (square both edges) No Add

EDGE OPTIONS

- "N" Seamless edge filled Add \$89
- "T" not available

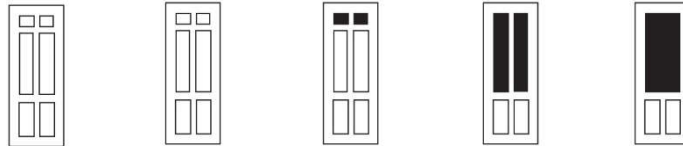

W	H	E6	E6	E62TL	E62FNVS	E6HGS
		18 GALV	16 GALV		18 GALV	18 GALV
*28, 210, 30	68	\$1,086	\$1,209	\$1,643	\$1,804	\$1,445
34, 36	68	\$1,282	NA	NA	\$2,000	\$1,641
*28, 210, 30	70	\$1,117	\$1,249	\$1,674	\$1,835	\$1,476
34, 36	70	\$1,315	NA	NA	\$2,033	\$1,674

* NOT AVAILABLE ADA COMPLIANT

ADA = Americans with Disabilities Act

3068 ADA Compliant door ADA Add \$32

NOTE: 3068 ADA compliant doors manufactured offsite and separately. Call to verify lead-times, freight cost, and ship schedule

LISTED FIRE LABEL DOORS

Label door restrictions per gauge and size can be determined in the General Information Section. Prices are without closer (CL).

			LESS CL
Underwriters Laboratories	ABCG	Add	\$65
Warnock Hersey	ABCG	Add	\$17
20 minute U.L. or W.H.I.		Add	\$17
Label Construction		Add	\$24
Verify label door limitations			

HALF GLASS 9 LITE CONVERSION KITS

Type 9 Standard

- Cellular PVC 9 Lite kit-20-1/2xw x 34-7/16h MS102566 \$710
- Aluminum 9 Lite – 20-1/2w x 34-7/16h MS102483 \$945

Type 1 Optional

- Cellular PVC 9 Lite kit-20-1/2xw x 34-7/16h MS007039 \$710
- Aluminum 9 Lite – 20-1/2w x 34-7/16h MS007013 \$945

(Order separately; add to HG type door, surface mount
PVC is a non-fire listed product, aluminum is a fire listed product)

- Type 2 kit, maximum 7/8" pocket.
- Interviewer (E6FP 1/2, E6FP 9/16) Add \$27
- Mail slot (E6MS) cutout only (std) Add \$60
- Vision Kits installed (3/8" pocket) Standard rim type kit Add \$967
- Steel Muntin E6HG9 (add to E6HGS)

NON STANDARD SIZE DOORS - contact factory
OVERSIZED DOOR OPTIONS - not available

707S Series Doors-Embossed Panel Flush Door Prices

May, 2024

EXTRAS

ASTRAGALS-Not available "B" Bevel

Specify "A" bevel, you must "hand" doors			
Z type blank screw applied	Z1	Add	\$96
Z type with strike E1 screw applied	Z1/E1	Add	\$159
Z type with strike and flush bolt screw applied	Z1/E1/H1	Add	\$246
Flat astragal screw applied		Add	\$88

CAPS — top or bottom

Steel installed flush (with screws per cap)		Add	\$26
---	--	-----	------

CLOSER

Surface mounted, reinforcement only		Add	\$36
Concealed or semi-concealed		Add	\$313

FLUSH BOLTS

Top and bottom flush bolt ANSI A115.4 (when used without astragal or with flat bar astragal)	H1	Add	\$87
Top and bottom surface bolt reinforced only	SB	Add	\$61

HINGE PREPARATIONS

4 1/2" standard or heavyweight		Standard	
5" Hinge standard or heavyweight		Add Each	\$9

LOCK PREPARATIONS

Cylindrical - 161	G2	Standard	
Cylindrical lock - lever trim holes (Universal lever trim prep.)	G2B	Standard	
Deadlock - tubular 181	G16	Standard	
Deadlock - mortise 190 (e.g. Sargent 4870)	G17	Add	\$87
Interconnected lock	G25	Add	\$58

EXTRAS

LOCK PREPARATIONS CONTINUED

Mortise lock - Escutcheon Trim	G3	Standard	
Mortise lock - Sectional Trim	G3A*	Standard	
Hotel and master ring cylinder functions	**G3A	Standard	
Mortise lock edge only preparation	G3AEO	Standard	
Mortise lock reinforce only	G3ARO	Standard	
Mortise panic exit	G12*	Add	\$87
Rim panic reinforce only	G11	Add	\$46
Rim panic reinforce with function holes	G11*	Add	\$46
Rim vertical rod reinforce only	G11A	Add	\$87
Rim vertical rod with function holes	G11A*	Add	\$87
Label Fire Pin (if required)		Add	\$30

LOUVERS -Preparation or installation is not available from the factory .

STRIKES

4 7/8" ANSI lipped strike (A bevel)	E1	Add	\$63
2 3/4" ANSI lipped strike (A bevel)	E2	Add	\$63
3 1/2" ANSI deadlock strike	E3	Add	\$63
2 3/4" ANSI deadlock strike	E4	Add	\$63
Electric Strike (A bevel)	E9*	Add	\$143
Electric raceway		Add	\$166
Open back strike (A bevel)	*	Add	\$143

*Advise of manufacturer and function of hardware

UNDERCUTS

5/8" standard, 3/8", 3/4" available		No Add	
All other undercuts per door		Add	\$24

8
**707S 1 OR 2-Panel Embossed 18 ga
 High Definition Embossed Panel
 Flush Door Prices**

May, 2024

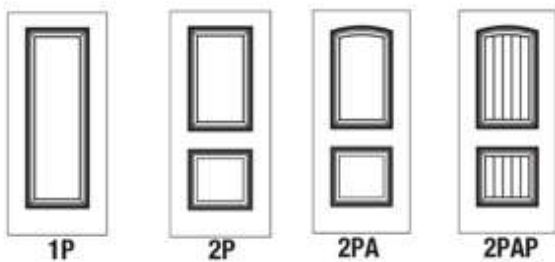

POLYSTYRENE CORE - STANDARD

	1P, 2P	2PA, 2PAP
3068	\$1,086	\$1,135
3070	\$1,117	\$1,166
3080	\$1,390	\$1,439

***POLYURETHANE CORE - OPTIONAL**

	1P, 2P	2PA, 2PAP
3068	\$1,234	\$1,283
3070	\$1,265	\$1,314
3080	\$1,538	\$1,587

*Doors are Polyurethane, not **Q_{MAX}**

STANDARD DESCRIPTION

Galvanneal (A40) steel 18 ga.
 Polystyrene Core Standard
 Polyurethane Core Optional (cannot be fire rated over 7')
 Edge bevel available
 "A" 1/8" in 2" lock edge - square hinge edge
 "B" Square both edges

EDGE OPTIONS

"S" Exposed edge seam N/C

Listed Fire Label Doors

Label door restrictions per gauge and size can be determined in the current CURRIES product brochure. Prices are without closer (CL).

LESS

CL

Underwriters Laboratories	ABCG	Add	\$65
Warnock Hersey	ABCG	Add	\$17
20 minute U.L. or W.H.I.		Add	\$17
Label Construction		Add	\$24
Verify label door limitations			

ASTRAGALS - Not available "B" Bevel

Specify "A" Bevel you must "hand" doors

Z type blank screw applied	Z1	Add	\$96
Z type with strike E1 screw applied	Z1/E1	Add	\$159
Z type with strike and flush bolt screw applied	Z1/E1/H1	Add	\$246
Flat astragal screw applied		Add	\$88

CAPS — top or bottom

Steel installed flush (with screws per cap) Add \$26

CLOSER

Surface mounted, reinforcement only Add \$36

FLUSH BOLTS OR SURFACE BOLTS

Top and bottom flush bolt ANSI A115.4 H1 Add \$87
 (when used without astragal or with flat bar astragal)

Top and bottom surface bolt reinforced only SB Add \$61

ADA Compliant

1 or 2 panel - 6'8" only Add \$32

HINGE PREPARATIONS

4 1/2" standard or heavyweight Standard

LOCK PREPARATIONS

Cylindrical 161 G2 Standard

Cylindrical locklever trim holes G2B Standard

(Universal lever trim prep.)

Deadlock tubular 181 G16 Standard

Deadlock mortise 190

(e.g. Sargent 4870) G17 Add \$87

Interconnected lock G25 Add \$58

Mortise lock - Escutcheon Trim G3 Standard

Mortise lock - Sectional Trim G3A* Standard

Hotel and master ring cylinder functions **G3A Standard

Mortise lock edge only preparation G3AEO Standard

Note: Mortise lock preps 30 wide door only

Rim panic reinforce only G11 Add \$46

Rim panic reinforce with function holes G11* Add \$46

Rim vertical rod reinforce only G11A Add \$87

Rim vertical rod with function holes G11A* Add \$87

LOUVERS: -preparation or installation is not available from the factory

STRIKES

4 7/8" ANSI lipped strike E1 Add \$63

2 3/4" ANSI lipped strike E2 Add \$63

3 1/2" ANSI deadlock strike E3 Add \$63

2 3/4" ANSI deadlock strike E4 Add \$63

Electric Strike (A bevel) E9* Add \$143

Electric raceway Add \$166

*Advise of manufacturer and function of hardware

UNDERCUTS

Minimum 3/4" No Add

All other undercuts per door Add \$24

NOTE: Charges waived when quantities exceed 24 doors with any combination of non standard undercut.

VISION KITS-Type 9 or 10 (only available on 2 panel design)

3/8" Pocket HG (2PHG) Add \$359

1/2" to 1-1/8" Pocket HG (2PHG) Add \$478

NOTE: This product is manufactured offsite and ship separately.

Call to verify lead times, freight cost, and ship schedule

707S CURRIStain (A1 & A2) Six Panel Door 18 Ga. Flush Door Prices

May, 2024

* Includes Type 1 Window Kit.
Kit is woodgrain and stained.

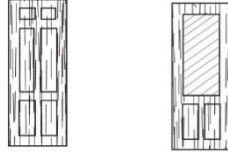

W	H	E6 18 GALV.	E6HGS* 18 GALV.
28, 210, 30	68	\$2,883	\$3,403
28, 210, 30	70	\$2,994	\$3,514
*36	68	\$3,391	\$3,911
*36	70	\$3,511	\$4,031

*Available in A2 Smooth Grain only

LISTED FIRE LABEL DOORS

Label door restrictions per gauge and size can be determined in the current CURRIES product brochure . Prices are without closer (CL)

				LESS CL
Underwriters Laboratories	ABCG	Add	\$65	
Warnock Hersey	ABCG	Add	\$17	
20 minute U .L . or W .H .I .		Add	\$17	
Label construction		Add	\$24	

Verify label door limitations

NON STANDARD SIZE DOORS - contact factory

OVERSIZED DOOR OPTIONS - not available

ASTRAGALS - Not available "B" bevel

Specify "A" bevel, you must "hand" doors

h type blank screw applied	K	Add	\$372
h type with strike E1 screw applied	K/E1	Add	\$435
h type with flush bolt screw applied	K/H1	Add	\$459
h type with strike and flush bolt screw applied	K/E1/H1	Add	\$522

CAPS - top or bottom

Steel installed flush (with screws per cap)	Add	\$26
---	-----	------

CLOSER

Surface mounted reinforcement only	Add	\$36
Concealed or semi-concealed	Add	\$313

FLUSH BOLTS

Top and bottom flush bolt ANSI A115.4 (When used without astragal)	H1	Add	\$87
Top and bottom surface bolt reinforce only	SB	Add	\$61

HINGE PREPARATIONS

4-1/2" standard or heavyweight	Standard
5" Hinge standard or heavyweight	Add Ea \$9

CURRIStain COLOR OPTIONS

Wheat, Natural, Cashew, Cocoa, Cabernet, Java

CUSTOM COLOR MATCH

Custom stain color match - inhouse factory formulatic Add \$158
Send physical sample to be matched to your Customer Service Professional.
*If we are unable to match your finish using our pre-formulated materials, additional formulation is available with extended lead time and a set up fee.

STANDARD DESCRIPTION

Polystyrene core

"S" exposed edge seam 1-3/4" thick doors only

A1 - CURRIStain galvanneal (A40) 18 ga w/embossed oak wood grain pattern

A2 - CURRIStain Smooth Grain galvanneal 18 ga w/tight grain stain design

EDGE BEVELS AVAILABLE

"A"	No Add
1/8" in 2" lock edge-square hinge edge	No Add
"B" standard (square both edges/non handed)	No Add

LOCK PREPARATIONS

Cylindrical - 161	G2	Standard
Cylindrical lock - Lever trim holes (Universal lever trim prep)	G2B	Standard
Deadlock - Tubular 181	G16	Standard
Deadlock - Mortise 190 (e.g. Sargent 4870)	G17	Add \$87
Interconnected lock	G25	Add \$58
Mortise lock - Escutcheon Trim	G3	Standard
Mortise lock - Sectional Trim	G2A*	Standard
Hotel and master ring cylinder functions	**G3A	Standard
Mortise lock edge only preparation	G3AEO	Standard
Mortise lock reinforce only	G3ARO	Standard
Mortise panic exit	G12*	Add \$87
Rim panic reinforce only	G11	Add \$46
Rim panic reinforce with function holes	G11	Add \$46
Rim vertical rod reinforce only	G11	Add \$46
Rim vertical Rod with function holes	G11A*	Add \$87

Louvers - preparation or installation is not available from the factory

STRIKES

4-7/8" ANSI lipped strike (A bevel)	E1	Add	\$63
2-3/4" ANSI lipped strike (A bevel)	E2	Add	\$63
3-1/2" ANSI deadlock strike	E3	Add	\$63
2-3/4" ANSI deadlock strike	E4	Add	\$63
Electric strike (A bevel)	E9	Add	\$143
Electric raceway		Add	\$166
Open back strike (A bevel) *		Add	\$143

* Advise of manufacturer and function of hardware

UNDERCUTS

3/4" minimum standard	No Add
All other undercuts per door	Add \$24

10 707S Series Doors - CURRIStain (A1 & A2) Polystyrene Core Flush Door Prices



May, 2024

WIDTH	HEIGHT		18 ga	16 ga	
20, 24, 26, 28 .210, 30	68		\$1,938	\$2,352	
34, 36	68		\$2,446	\$2,860	
38, 310, 40	68		\$2,727	\$3,142	
20, 24, 26, 28 .210, 30	70		\$2,049	\$2,489	
34, 36	70		\$2,566	\$3,009	
38, 310, 40	70		\$2,888	\$3,330	
20, 24, 26, 28 .210, 30	72		\$2,246	\$2,725	
34, 36	72		\$2,711	\$3,189	
38, 310, 40	72		\$2,996	\$3,474	
30	80		\$2,798	\$3,323	
34, 36	80		\$3,246	\$3,769	
38, 310, 40	80		\$3,513	\$4,037	
30	90		\$4,244	\$4,821	
34, 36	90		\$4,708	\$5,285	
38, 310, 40	90		\$4,922	\$5,499	

STANDARD DESCRIPTION

Polystyrene core with an "A" edge bevel and exposed seam "S" edge

1 3/4" thick doors

Galvanneal (A40) included in price

FINISH OPTIONS

A1 - Galvanneal (A40) 18 ga w/embossed oak wood grain pattern No Add

A2 - Smooth Grain galvanneal 18 ga w/tight grain stain design No Add

EDGE BEVELS AVAILABLE

"A" standard (1/8" in 2" lock edge-square hinge edge) No Add

"B" specify (square both edges) No Add

"G" specify (1/8" in 2" bevel both edges) Add \$18

OPTIONS

Honeycomb core Add \$44

QMAX thermally enhanced core Add \$148

Visual ID tag Add \$6

LISTED FIRE LABEL DOORS

Label door restrictions per gauge and size can be determined

in the current CURRIES product brochure . Prices are without closer (CL LESS CL

Underwriters Laboratories ABCG Add \$65

Warnock Hersey ABCG Add \$17

20 minute U .L . or W .H .I . Add \$17

Label construction Add \$24

"TOUCH UP" STAIN MARKING PENS

Natural	MS007104	\$72	List
Cashew	MS007112	\$72	List
Wheat	MS007120	\$72	List
Cocoa	MS007138	\$72	List
Cabernet	MS007146	\$72	List
Java	MS007153	\$72	List

Specify stain color when ordering

Natural, Cashew, Wheat, Cocoa, Cabernet, Java

CUSTOM COLOR MATCH

Custom stain color match - inhouse factory formulat Add \$158

Send physical sample to be matched to your Customer Service Professional.

*If we are unable to match your finish using our pre-formulated materials, additional formulation is available with extended lead time and a set up fee.

NON STANDARD SIZE DOORS

Price as the next largest standard size door



CURRIStain®

EXTRAS

ASTRAGALS

"h" Astragal installed on inactive leaf-Code K on order form			
h blank	K		\$372
h w/E1 strike prep	K/E1		\$435
h w/H1 F. Bolt prep	K/H1		\$459
h w/E1 H1 prep	K/E1/H1		\$522

CAPS — top or bottom

Steel installed flush (with screws per cap)		Add	\$26
---	--	-----	------

CLOSER

Surface mounted, reinforcement only		Add	\$36
Concealed or semi-concealed		Add	\$313

DUTCH DOOR (SHELF EXTRA)

		Add	\$358
--	--	-----	-------

Shelf is not wood grain

FLUSH BOLTS OR SURFACE BOLTS

Top and bottom flush bolt ANSI A115.4	H1	Add	\$87
(when used without astragal or with flat bar astragal)			
Top and bottom surface bolt reinforced only	SB	Add	\$61

HINGE PREPARATIONS

4 1/2" standard or heavyweight		Standard	
5" Hinge standard or heavyweight		Add Each	\$9
1 1/2 pair up to and including 7'6"		Standard	
2 pair over 7'6" to 10'0"		Standard	

Anchor hinge set

(e.g. McKinney TA792) No drill, no tap		Add	\$203
(e.g. McKinney TA793)		No Add	

Continuous hinge preparation(mounting holes field drilled)

Concealed mounting		No Add	
--------------------	--	--------	--

(e.g. McKinney 11, 24)

12 gauge hinge rail available (Specify)		No Add	
---	--	--------	--

Surface mounting

(e.g. McKinney 21, 53)		Add	\$108
------------------------	--	-----	-------

LOCK PREPARATIONS

Cylindrical lock - 161	G2	Standard	
Cylindrical lock - lever trim	G2B	Standard	
(Universal lever trim prep.)			
Deadlock - tubular 181	G16	Standard	
Deadlock - mortise 190	G17	Add	\$87
Interconnected lock	G25	Add	\$58

EXTRAS

LOCK PREPARATIONS CONTINUED

Mortise lock - Escutcheon Trim	G3	Standard	
Mortise lock - Sectional Trim	G3A*	Standard	
Hotel and master ring cylinder functions	**G3A	Standard	
Mortise lock edge only preparation	G3AEO	Standard	
Mortise lock reinforce only	G3ARO	Standard	
Mortise panic exit	G12*	Add	\$87
Rim panic reinforce only	G11	Add	\$46
Rim panic reinforce with function holes	G11*	Add	\$46
Rim vertical rod reinforce only	G11A	Add	\$87
Rim vertical rod with function holes	G11A*	Add	\$87
Concealed vertical rods	G12A*	Add	\$578
Low profile vertical rod	G12B	Add	\$578
Recessed vertical rod	G13C	Add	\$578
Mortise panic ctr & bottom latch	G14C	Add	\$141
Label Fire Pin (if required)		Add	\$30

LOUVERS

Louver cutout only		Add	\$81
Louver cutout surround with channel		Add	\$142
(label louver requirement)			

STRIKES

4 7/8" ANSI lipped strike	E1	Add	\$63
2 3/4" ANSI lipped strike	E2	Add	\$63
3 1/2" ANSI deadlock strike	E3	Add	\$63
2 3/4" ANSI deadlock strike	E4	Add	\$63
Electric Strike	E9*	Add	\$143
Electric raceway		Add	\$166
Open back strike	*	Add	\$143

*Advise of manufacturer and function of hardware

UNDERCUTS

5/8" standard, 3/8", 3/4" available		No Add	
		Add	\$24

VISION KITS-Type 1 Standard

Vision kits installed (3/8" pocket) standard rim type kit			
FV		Add	\$416
FNV		Add	\$489
HG		Add	\$520
FG		Add	\$734

NOTE: For additional window options refer to the Engineered Door Section

727S Series Doors - CURRIStain (A1 & A2) Temp Rise 250° & 450° Flush Door Prices



May, 2024

WIDTH	HEIGHT		18 ga	16 ga	
20, 24, 26, 28 .210, 30	68		\$3,428	\$3,847	
34, 36	68		\$4,096	\$4,514	
38, 310, 40	68		\$4,443	\$4,861	
20, 24, 26, 28 .210, 30	70		\$3,479	\$3,926	
34, 36	70		\$4,185	\$4,629	
38, 310, 40	70		\$4,565	\$5,012	
20, 24, 26, 28 .210, 30	72		\$3,692	\$4,174	
34, 36	72		\$4,333	\$4,815	
38, 310, 40	72		\$4,676	\$5,158	
30	80		\$4,717	\$5,245	
34, 36	80		\$5,269	\$5,798	
38, 310, 40	80		\$5,627	\$6,157	

STANDARD DESCRIPTION

Composite core with "A" edge bevel and exposed seam "S" edge standard.
Galvanneal (A40) included in price
1 3/4" thick doors
250° or 450° rating available. Price is the same, specify rating when ordering

FINISH OPTIONS

A1 - Galvanneal (A40) 18 ga w/embossed oak wood grain pattern No Add
A2 - Smooth Grain galvanneal 18 ga w/tight grain stain design No Add

EDGE BEVELS AVAILABLE

"A" standard (1/8" in 2" lock edge-square hinge edge) No Add
"B" specify (square both edges) No Add
"G" specify (1/8" in 2" bevel both edges) Add \$18

LISTED FIRE LABEL DOORS

Label door restrictions per gauge and size can be determined in the current CURRIES product brochure . Prices are without closer (CL).

LESS
CL

Underwriters Laboratories ABC Add \$65
Warnock Hersey ABC Add \$17
Label construction Add \$24

NON STANDARD SIZE DOORS

Price as the next largest standard size door

4080 maximum single door
8080 maximum pair door

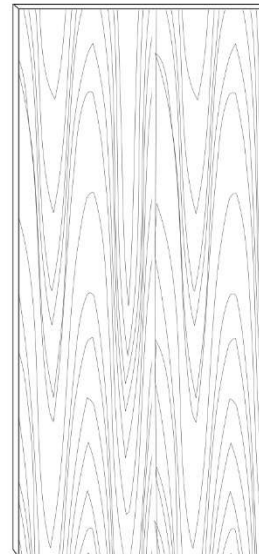

"TOUCH UP" STAIN MARKING PENS

Natural	MS007104	\$72	List
Cashew	MS007112	\$72	List
Wheat	MS007120	\$72	List
Cocoa	MS007138	\$72	List
Cabernet	MS007146	\$72	List
Java	MS007153	\$72	List

Specify stain color when ordering
Natural, Cashew, Wheat, Cocoa, Cabernet, Java

CUSTOM COLOR MATCH

Custom stain color match - inhouse factory formulat Add \$158
Send physical sample to be matched to your Customer Service Professional.
*If we are unable to match your finish using our pre-formulated materials, additional formulation is available with extended lead time and a set up fee.



EXTRAS
ASTRAGALS

"h" Astragal installed on inactive leaf-Code K on h blank	K	\$372
h w/E1 strike prep	K/E1	\$435
h w/H1 F. Bolt prep	K/H1	\$459
h w/E1 H1 prep	K/E1/H1	\$522

CAPS — top or bottom

Steel installed flush (with screws per cap)	Add	\$26
---	-----	------

CLOSER

Surface mounted, reinforcement only	Add	\$36
Concealed or semi-concealed	Add	\$313

FLUSH BOLTS OR SURFACE BOLTS

Top and bottom flush bolt ANSI A115.4 (when used without astragal or with flat bar astragal)	H1	Add	\$87
Top and bottom surface bolt reinforced only	SB	Add	\$61

HINGE PREPARATIONS

4 1/2" standard or heavyweight	Standard	
5" Hinge standard or heavyweight	Add Each	\$9
1 1/2 pair up to and including 7'6"	Standard	
2 pair over 7'6" to 10'0"	Standard	
Anchor hinge set (e.g. McKinney TA792) No drill, no tap (e.g. McKinney TA793)	Add	\$203
Continuous hinge preparation(mounting holes field drilled)	No Add	
Concealed mounting (e.g. McKinney 11, 24)	No Add	
12 gauge hinge rail available (Specify)	No Add	
Surface mounting (e.g. McKinney 21, 53)	Add	\$108

LOCK PREPARATIONS

Cylindrical lock - 161	G2	Standard
Cylindrical lock - lever trim holes (Universal lever trim prep .)	G2B*	Standard
Deadlock - tubular 181	G16	Standard
Deadlock - mortise 190	G17	Add \$87

EXTRAS
LOCK PREPARATIONS CONTINUED

Mortise lock - Escutcheon Trim	G3	Standard
Mortise lock - Sectional Trim	G3A*	Standard
Hotel and master ring cylinder functions	**G3A	Standard
Mortise lock edge only preparation	G3AEO	Standard
Mortise lock reinforce only	G3ARO	Standard
Mortise panic exit	G12*	Add \$87
Rim panic reinforce only	G11	Add \$46
Rim panic reinforce with function holes	G11*	Add \$46
Rim vertical rod reinforce only	G11A	Add \$87
Rim vertical rod with function holes	G11A*	Add \$87
Concealed vertical rods	G12A*	Add \$578
Label Fire Pin (if required)		Add \$30

STRIKES

4 7/8" ANSI lipped strike	E1	Add	\$63
2 3/4" ANSI lipped strike	E2	Add	\$63
3 1/2" ANSI deadlock strike	E3	Add	\$63
2 3/4" ANSI deadlock strike	E4	Add	\$63
Electric Strike	E9*	Add	\$143
Electric raceway		Add	\$166

*Advise of manufacturer and function of hardware

UNDERCUTS

5/8" standard, 3/8", 3/4" available	No Add	
All other undercuts per door	Add	\$24

VISION KITS-Type 1 Standard

Vision kits installed (3/8" pocket) standard rim type kit		
FV	Add	\$416
FNV	Add	\$489

VISION KITS-Type 2 Standard

Vision kits installed-standard rim type kit (specify 5/8", 7/8", or 1-1/8" pocket) Type 2		
FV	Add	\$602
FNV	Add	\$675

727S Series Doors - Temp. Rise 250° & 450°

Flush Door Prices

May, 2024



WIDTH	HEIGHT		18 ga	16 ga	
20, 24, 26, 28 .210, 30	68		\$1,417	\$1,626	
34, 36	68		\$1,621	\$1,829	
38, 310, 40	68		\$1,711	\$1,920	
20, 24, 26, 28 .210, 30	70		\$1,438	\$1,660	
34, 36	70		\$1,644	\$1,866	
38, 310, 40	70		\$1,738	\$1,962	
20, 24, 26, 28 .210, 30	72		\$1,486	\$1,728	
34, 36	72		\$1,670	\$1,910	
38, 310, 40	72		\$1,760	\$2,000	
30	80		\$1,845	\$2,110	
34, 36	80		\$1,993	\$2,257	
38, 310, 40	80		\$2,096	\$2,360	

STANDARD DESCRIPTION

Composite core with an "A" edge bevel and exposed seam "S" edge are standard
 1 3/4" thick doors
 250° or 450° rating available. Price is the same, specify rating when ordering

EDGE BEVELS AVAILABLE

"A" standard (1/8" in 2" lock edge-square hinge edge) No Add
 "B" specify (square both edges) No Add
 "G" specify (1/8" in 2" bevel both edges) Add \$18
NOTE: For other edge bevels refer to Engineered Door Section

Galvanneal Steel (A40 & A60)

		A40	A60
a) 68 HEIGHT	Add	\$48	\$97
b) 70 HEIGHT	Add	\$48	\$103
c) 72 HEIGHT	Add	\$48	\$111
d) 80 HEIGHT	Add	\$48	\$118

Galvanized (G90) includes epoxy primer

a) 68 HEIGHT	Add	\$354
b) 70 HEIGHT	Add	\$361
c) 72 HEIGHT	Add	\$367
d) 80 HEIGHT	Add	\$373

"N" Seamless edge filled	Add	\$89
"T" Continuous wire welded	Add	\$143
Visual ID tag	Add	\$6

LISTED FIRE LABEL DOORS (Prices are without closer CL):

		LESS	CL
Underwriters Laboratories	ABC Add	\$65	
Warnock Hersey	ABC Add	\$17	
Label construction	Add	\$24	

OVERSIZED DOOR OPTIONS-AVAILABLE AS 450° ON PAGE 18 AND 19

NON STANDARD SIZE DOORS

Price as the next largest standard size door

4080 maximum single door

8080 maximum pair door

EXTRAS

ASTRAGALS

Z type blank screw applied	Z1	Add	\$96
Z type with strike E1 screw applied	Z1E1	Add	\$159
Z type with strike and flush bolt screw applied	Z1/E1/H1	Add	\$246
Flat astragal screw applied		Add	\$88

CAPS — top or bottom

Steel installed flush (with screws per cap)		Add	\$26
---	--	-----	------

CLOSER

Surface mounted, reinforcement only		Add	\$36
Concealed or semi-concealed		Add	\$313

FLUSH BOLTS OR SURFACE BOLTS

Top and bottom flush bolt ANSI A115.4 (when used without astragal or with flat bar astragal)	H1	Add	\$87
Top and bottom surface bolt reinforced only	SB	Add	\$61

HINGE PREPARATIONS

4 1/2" standard or heavyweight		Standard	
5" Hinge standard or heavyweight		Add Each	\$9
1 1/2 pair up to and including 7"6"		Standard	
2 pair over 7"6" to 10'0"		Standard	
Anchor hinge set (e.g. McKinney TA792) No drill, no tap		Add	\$203
(e.g. McKinney TA793)		No Add	
Continuous hinge preparation(mounting holes field drilled)		No Add	
Concealed mounting (e.g. McKinney 11, 24)		No Add	
12 gauge hinge rail available (Specify)		No Add	
Surface mounting (e.g. McKinney 21, 53)		Add	\$108

LOCK PREPARATIONS

Cylindrical lock - 161	G2	Standard	
Cylindrical lock - lever trim (Universal lever trim prep .)	G2B	Standard	
Deadlock - tubular 181	G16	Standard	
Deadlock - mortise 190	G17	Add	\$87

EXTRAS

LOCK PREPARATIONS CONTINUED

Mortise lock - Escutcheon Trim	G3	Standard	
Mortise lock - Sectional Trim	G3A*	Standard	
Hotel and master ring cylinder	**G3A	Standard	
Mortise lock edge only preparation	G3AEO	Standard	
Mortise lock reinforce only	G3ARO	Standard	
Mortise panic exit	G12*	Add	\$87
Rim panic reinforce only	G11	Add	\$46
Rim panic reinforce with function holes	G11*	Add	\$46
Rim vertical rod reinforce only	G11A	Add	\$87
Rim vertical rod with function holes	G11A*	Add	\$87
Concealed vertical rods	G12A*	Add	\$578
Label Fire Pin (if required)		Add	\$30

STRIKES

4 7/8" ANSI lipped strike	E1	Add	\$63
2 3/4" ANSI lipped strike	E2	Add	\$63
3 1/2" ANSI deadlock strike	E3	Add	\$63
2 3/4" ANSI deadlock strike	E4	Add	\$63
Electric Strike	E9*	Add	\$143
Electric raceway		Add	\$166

*Advise of manufacturer and function of hardware

UNDERCUTS

5/8" standard, 3/8", 3/4" available	No Add	
All other undercuts per door	Add	\$24

VISION KITS-Type 9 Standard or Optional Type 1

Vision kits installed (3/8" pocket) standard rim type kit		
FV	Add	\$228
FNV	Add	\$255

VISION KITS-Type 10 Standard or Optional Type 2

Vision kits installed -standard rim type kit (specify 9/16", 13/16", or 1-1/16" pocket) Type 10 (specify 5/8", 7/8", or 1-1/8" pocket) Type 2		
FV	Add	\$347
FNV	Add	\$374

16 747S Series Doors - Steel Stiffened Flush Door Prices

May, 2024



WIDTH	HEIGHT		18 ga	16 ga	14 ga
20, 24, 26, 28 .210, 30	68		\$937	\$1,080	\$1,389
34, 36	68		\$1,151	\$1,296	\$1,606
38, 310, 40	68		\$1,278	\$1,424	\$1,734
20, 24, 26, 28 .210, 30	70		\$953	\$1,107	\$1,438
34, 36	70		\$1,186	\$1,340	\$1,672
38, 310, 40	70		\$1,326	\$1,480	\$1,812
20, 24, 26, 28 .210, 30	72		\$1,028	\$1,194	\$1,547
34, 36	72		\$1,231	\$1,396	\$1,752
38, 310, 40	72		\$1,364	\$1,528	\$1,886
30	80		\$1,291	\$1,467	\$1,843
34, 36	80		\$1,481	\$1,657	\$2,036
38, 310, 40	80		\$1,605	\$1,782	\$2,161
30	90		\$1,893	\$2,083	\$2,484
34, 36	90		\$2,089	\$2,280	\$2,684
38, 310, 40	90		\$2,189	\$2,380	\$2,784
30	100		\$2,194	\$2,397	\$2,828
34, 36	100		\$2,384	\$2,588	\$3,022
38, 310, 40	100		\$2,493	\$2,697	\$3,131

OVERSIZED DOOR OPTIONS

Doors over 4' wide and 8' high are factory crated for protection in transit

18 gauge oversized doors are **not available**

All door widths over 4'0" up to 5'0" & all door heights over 10'0" up to 12'0":

16 gauge A6 max size 5' x 12' add to the 40 x 100 price \$3,076

14 gauge A6 max size 5' x 12' add to the 40 x 100 price \$3,076

STANDARD DESCRIPTION

Steel stiffened core with "A" edge bevel and exposed seam "S" edge are standard

1 3/4" thick doors and 22 gauge stiffeners

20 gauge stiffeners

Add \$65

EDGE BEVELS AVAILABLE

"A" standard (1/8" in 2" lock edge-square hinge edge

No Add

"B" specify (square both edges)

No Add

"G" specify (1/8" in 2" bevel both edges)

Add \$18

NOTE: For other edge bevels refer to Engineered Door Section

Galvanneal Steel (A40 & A60)

A40 **A60**

a) 68 HEIGHT

Add \$48 \$97

b) 70 HEIGHT

Add \$48 \$103

c) 72 HEIGHT

Add \$48 \$111

d) 80 HEIGHT

Add \$48 \$118

e) 90 HEIGHT

Add \$56 \$124

f) 100 HEIGHT

Add \$56 \$131

Galvanized (G90) includes epoxy primer

a) 68 HEIGHT

Add \$354

b) 70 HEIGHT

Add \$361

c) 72 HEIGHT

Add \$367

d) 80 HEIGHT

Add \$373

e) 90 HEIGHT

Add \$382

f) 100 HEIGHT

Add \$395

"N" seamless edge filled

Add \$89

"T" Continuous wire welded

Add \$143

Visual ID tag

Add \$6

Label door restrictions per gauge and size can be determined

in the current CURRIES product brochure . Prices are without closer (CL).

Underwriters Laboratories

ABCG

Add \$65

Warnock Hersey

ABCG

Add \$17

20 minute U . L . or W . H . I .

Add \$17

Label construction

Add \$24

NON STANDARD SIZE DOORS

Price as the next largest standard size door

**NOTE: Doors greater than 10' height will be manufactured offsite and shipped separately.
Call to verify lead-times, freight cost, and ship schedule**

EXTRAS

ASTRAGALS

Z type blank screw applied	Z1	Add	\$96
Z type with strike E1 screw applied	Z1E1	Add	\$159
Z type with strike and flush bolt screw applied	Z1/E1/H1	Add	\$246
Flat astragal screw applied		Add	\$88

CAPS — top or bottom

Steel installed flush (with screws per cap)		Add	\$26
---	--	-----	------

CLOSER

Surface mounted, reinforcement only		Add	\$36
Concealed or semi-concealed		Add	\$313

DUTCH DOOR (SHELF EXTRA)

Add \$358

FLUSH BOLTS OR SURFACE BOLTS

Top and bottom flush bolt ANSI A115.4 (when used without astragal or with flat bar astragal)	H1	Add	\$87
Top and bottom surface bolt reinforced only	SB	Add	\$61

HINGE PREPARATIONS

4 1/2" standard or heavyweight		Standard	
5" Hinge standard or heavyweight		Add Each	\$9
1 1/2 pair up to and including 7'6"		Standard	
2 pair over 7'6" to 10'0"		Standard	
Anchor hinge set (e.g. McKinney TA792) No drill, no tap (e.g. McKinney TA793)		Add	\$203
		No Add	
Continuous hinge preparation (mounting holes field drilled)		No Add	
Concealed mounting (e.g. McKinney 11, 24)		No Add	
12 gauge hinge rail available (Specify)		No Add	
Surface mounting (e.g. McKinney 21, 53)		Add	\$108

LOCK PREPARATIONS

Cylindrical lock - 161	G2	Standard	
Cylindrical lock - lever trim (Universal lever trim prep.)	G2B*	Standard	
Deadlock - tubular 181	G16	Standard	
Deadlock - mortise 190	G17	Add	\$87
Interconnected lock	G25	Add	\$58

EXTRAS

LOCK PREPARATIONS CONTINUED

Mortise lock - Escutcheon Trim	G3	Standard	
Mortise lock - Sectional Trim	G3A*	Standard	
Hotel and master ring cylinder functions	**G3A	Standard	
Mortise lock edge only preparation	G3AEO	Standard	
Mortise lock reinforce only	G3ARO	Standard	
Mortise panic exit	G12*	Add	\$87
Rim panic reinforce only	G11	Add	\$46
Rim panic reinforce with function holes	G11*	Add	\$46
Rim vertical rod reinforce only	G11A	Add	\$87
Rim vertical rod with function holes	G11A*	Add	\$87
Concealed vertical rods	G12A*	Add	\$578
Low profile vertical rod	G12B	Add	\$578
Recessed vertical rod	G13C	Add	\$578
Mortise panic ctr & bottom latch	G14C	Add	\$141
Label Fire Pin (if required)		Add	\$30

LOUVERS

Louver cutout only		Add	\$81
Louver cutout surround with channel (label louver requirement)		Add	\$142

REPLACEMENT DOOR

3 Hinge preps		Add	\$31
4 Hinge preps		Add	\$42

STRIKES

4 7/8" ANSI lipped strike	E1	Add	\$63
2 3/4" ANSI lipped strike	E2	Add	\$63
3 1/2" ANSI deadlock strike	E3	Add	\$63
2 3/4" ANSI deadlock strike	E4	Add	\$63
Electric Strike	E9*	Add	\$143
Electric raceway		Add	\$166
Open back strike	*	Add	\$143

*Advise of manufacturer and function of hardware

UNDERCUTS

5/8" standard, 3/8", 3/4" available		No Add	
All other undercuts per door		Add	\$24

VISION KITS - Type 9 Standard or Optional Type 1

VISION kits installed (3/8" pocket) standard rim type kit			
FV		Add	\$228
FNV		Add	\$255
HG		Add	\$298
FG		Add	\$420
FL cutout only		Add	\$81

NOTE: For additional window options refer to the Engineered Door Section**SWIFT PAC**

Preprinted manufacturered order forms are available in the CURRIES Partner Area of the website.

WIDTH	HEIGHT	18 ga	16 ga
20, 24, 26, 28 .210, 30	68	\$1,499	\$1,728
34, 36	68	\$1,842	\$2,074
38, 310, 40	68	\$2,045	\$2,278
20, 24, 26, 28 .210, 30	70	\$1,525	\$1,771
34, 36	70	\$1,898	\$2,144
38, 310, 40	70	\$2,122	\$2,368
20, 24, 26, 28 .210, 30	72	\$1,645	\$1,910
34, 36	72	\$1,970	\$2,234
38, 310, 40	72	\$2,182	\$2,445
30	80	\$2,066	\$2,347
34, 36	80	\$2,370	\$2,651
38, 310, 40	80	\$2,568	\$2,851
30	90	\$3,029	\$3,333
34, 36	90	\$3,342	\$3,648
38, 310, 40	90	\$3,502	\$3,808
30	100	\$3,510	\$3,835
34, 36	100	\$3,814	\$4,141
38, 310, 40	100	\$3,989	\$4,315

STANDARD DESCRIPTION

Steel stiffened core with an "A" edge bevel and exposed seam "S" edge are standard

1 3/4" thick doors and 20 gauge stiffeners

EDGE BEVELS AVAILABLE

"A" standard (1/8" in 2" lock edge-square hinge edge) No Add

"B" specify (square both edges) No Add

"G" specify (1/8" in 2" bevel both edges) Add \$18

NOTE: For other edge bevels refer to Engineered Door Section

Galvanneal Steel (A40 & A60)

	A40	A60
a) 68 HEIGHT	Add \$48	\$97
b) 70 HEIGHT	Add \$48	\$103
c) 72 HEIGHT	Add \$48	\$111
d) 80 HEIGHT	Add \$48	\$118
e) 90 HEIGHT	Add \$56	\$124
f) 100 HEIGHT	Add \$56	\$131

Galvanized (G90) includes epoxy primer

a) 68 HEIGHT	Add \$354
b) 70 HEIGHT	Add \$361
c) 72 HEIGHT	Add \$367
d) 80 HEIGHT	Add \$373
e) 90 HEIGHT	Add \$382
f) 100 HEIGHT	Add \$395

"N" seamless edge filled Add \$89

"T" Continuous wire welded Add \$143

Visual ID tag Add \$6

NON STANDARD SIZE DOORS

Price as the next largest standard size door

LISTED FIRE LABEL DOORS (Prices are without closer CL):

Warnock Hersey only	ABCG	LESS CL	Add \$17
Label construction			Add \$24

Maximum 1-1/2 hour fire rating

5' x 10' maximum single door

10' x 10' maximum pair or double egress doors

747S TR Series Doors - Temp. Rise Flush Door Prices

May, 2024

EXTRAS

ASTRAGALS

Z type blank screw applied	Z1	Add	\$96
Z type with strike E1 screw applied	Z1E1	Add	\$159
Z type with strike and flush bolt screw applied	Z1/E1/H1	Add	\$246
Flat astragal screw applied		Add	\$88

CAPS — top or bottom

Steel installed flush (with screws per cap)		Add	\$26
---	--	-----	------

CLOSER

Surface mounted, reinforcement only		Add	\$36
Concealed or semi-concealed		Add	\$313

FLUSH BOLTS OR SURFACE BOLTS

Top and bottom flush bolt ANSI A115.4 (when used without astragal or with flat bar astragal)	H1	Add	\$87
Top and bottom surface bolt reinforced only	SB	Add	\$61

HINGE PREPARATIONS

4 1/2" standard or heavyweight		Standard	
5" Hinge standard or heavyweight		Add Each	\$9
1 1/2 pair up to and including 7'6"		Standard	
2 pair over 7'6" to 10'0"		Standard	
Anchor hinge set (e.g. McKinney TA792) No drill, no tap (e.g. McKinney TA793)		Add	\$203
Continuous hinge preparation(mounting holes field drilled)		No Add	
Concealed mounting (e.g. McKinney 11, 24)		No Add	
12 gauge hinge rail available (Specify)		No Add	
Surface mounting (e.g. McKinney 21, 53)		Add	\$108

LOCK PREPARATIONS

Cylindrical lock - 161	G2	Standard	
Cylindrical lock - lever trim holes (Universal lever trim prep .)	G2B*	Standard	
Deadlock - tubular 181	G16	Standard	
Deadlock - mortise 190	G17	Add	\$87

EXTRAS

LOCK PREPARATIONS CONTINUED

Mortise lock - Escutcheon Trim	G3	Standard	
Mortise lock - Sectional Trim	G3A*	Standard	
Hotel and master ring cylinder functions	**G3A	Standard	
Mortise lock edge only preparation	G3AEO	Standard	
Mortise lock reinforce only	G3ARO	Standard	
Mortise panic exit	G12*	Add	\$87
Rim panic reinforce only	G11	Add	\$46
Rim panic reinforce with function holes	G11*	Add	\$46
Rim vertical rod reinforce only	G11A	Add	\$87
Rim vertical rod with function holes	G11A*	Add	\$87
Concealed vertical rods	G12A*	Add	\$578
Label Fire Pin (if required)		Add	\$30

STRIKES

4 7/8" ANSI lipped strike	E1	Add	\$63
2 3/4" ANSI lipped strike	E2	Add	\$63
3 1/2" ANSI deadlock strike	E3	Add	\$63
2 3/4" ANSI deadlock strike	E4	Add	\$63
Electric Strike	E9*	Add	\$143
Electric raceway		Add	\$166

*Advise of manufacturer and function of hardware

UNDERCUTS

5/8" standard, 3/8", 3/4" available	No Add	
All other undercuts per door	Add	\$24

VISION KITS - Type 9 Standard or Optional Type 1

Vision kits installed (3/8" pocket) standard rim type kit		
FV	Add	\$228
FNV	Add	\$255

VISION KITS-Type 10 Standard or Optional Type 2

Vision kits installed - standard rim type kit (specify 9/16", 13/16", or 1-1/16" pocket) Type 10 (specify 5/8", 7/8", or 1-1/8" pocket) Type 2		
FV	Add	\$347
FNV	Add	\$374

767S Stile and Rail Door - 16 Ga.

Flush Door Prices

May, 2024



WIDTH	HEIGHT	3-5/8" Rail	5-5/8" Rail	7-5/8" Rail
		16 GA	16 GA	16 GA
26,28, 30	68	\$1,622	\$1,645	\$1,672
34, 36	68	\$1,834	\$1,862	\$1,890
38, 40	68	\$1,940	\$1,967	\$2,043
26,28, 30	70	\$1,650	\$1,678	\$1,705
34, 36	70	\$1,859	\$1,890	\$1,916
38, 40	70	\$1,976	\$2,006	\$2,077
26,28, 30	72	\$1,734	\$1,759	\$1,785
34, 36	72	\$1,913	\$1,942	\$2,009
38, 40	72	\$2,015	\$2,046	\$2,133
26,28, 30	80	\$1,947	\$1,978	\$2,008
34, 36	80	\$2,103	\$2,131	\$2,157
38, 40	80	\$2,189	\$2,217	\$2,290

2'10", 3'10" wide & 6'10" and 7' 10" high

Price next larger door size

Pairs of doors - take one single and multiply by 2

1. Flush integral glazing standard, 3/8" pocket designed for 1/4" glass
Glass not included
2. Head rails and jamb stiles are available in 3-5/8", 5-5/8" or 7-5/8" dimensions (standard is 5-5/8")
3. Bottom rail is nominal size with 12-5/8" standard. Optional 10-5/8", 14-5/8" or 16-5/8" in 2" increments
4. (16 CRS) is 16 Ga. Cold roller standard. Option for 16 ga. A60 galvaneel steel
5. Stiles and rails have fiberglass insulation. Concealed hardware in top rail not available.
6. Narrow style hardware required on 3-5/8" rails
7. Maximum door size is 4080. Only 16 ga is available
8. Raceways, electric hinges, and EPT's are not allowed.

BOTTOM RAIL(OTHER THAN 12-5/8")

10-5/8", 14-5/8" OR 16-5/8" in 2" increments
1-3/4" thick doors with 22 gauge

BR \$111

GALVANNEAL STEEL (A40 & A60)

ASTM 924 Prime Painted

A40 **A60**

- a) 68 HEIGHT Add \$48 \$97
- b) 70 HEIGHT Add \$48 \$103
- c) 72 HEIGHT Add \$48 \$111
- d) 80 HEIGHT Add \$48 \$118

CENTER RAIL (add per rail)

Per 3-5/8" nominal
5-5/8" nominal
7-5/8" nominal

CR35/8 Add \$381
CR55/8 Add \$390
CR75/8 Add \$399

OPTIONAL GLASS POCKET WIDTH (add per lite)

1/2" glass to 1" glass - Add per lite DG \$186

CLOSER REINFORCEMENT

12 GA - 20" C2 Add \$43

SPECIAL SIZE

Price next larger size

WELDED ON PLATE ASTRAGAL

- Steel plate welded on the door 1 Add \$108
 - Inactive leaf strike preparation E1 Add \$63
 - Inactive leaf flush bolt preparation H1 Add \$87
 - Inactive leaf open back strike prep * Add \$114
- *Advise of manufacturer and functions

UL OR WH FIRE LABEL

Prices are without closer (CL) LESS CL
20 or 45 minute using wire glass UL Add \$65
Maximum 4080 single, 8080 double W Add \$17

GP DESIGN (glass top, center rail)

Glass top, Center rail and 3/8" bottom. Steel sandwich panel price includes panel and installation) GP Add \$848

2P DESIGN Stile and Rail

Center rail, top and bottom 2PSR Add \$1,289
3/8" steel sandwich panel (price includes panel and installation)

**NOTE: This product is manufactured offsite and ship separately.
Call to verify lead-times, freight cost, and ship schedule**

777S Series Doors - Trio Steel Stiffened - Fiberglass Filled Flush Door Prices

May, 2024



WIDTH	HEIGHT		18 ga	16 ga	14 ga
20, 24, 26, 28 .210, 30	68		\$950	\$1,087	\$1,603
34, 36	68		\$1,159	\$1,297	\$1,810
38, 310, 40	68		\$1,292	\$1,431	\$1,948
20, 24, 26, 28 .210, 30	70		\$966	\$1,111	\$1,629
34, 36	70		\$1,195	\$1,341	\$1,862
38, 310, 40	70		\$1,335	\$1,482	\$2,008
20, 24, 26, 28 .210, 30	72		\$1,038	\$1,197	\$1,719
34, 36	72		\$1,242	\$1,403	\$1,929
38, 310, 40	72		\$1,370	\$1,532	\$2,058
20, 24, 26, 28 .210, 30	80		\$1,301	\$1,472	\$2,001
34, 36	80		\$1,487	\$1,659	\$2,192
38, 310, 40	80		\$1,614	\$1,789	\$2,320
30	90		\$1,901	\$2,090	\$2,629
34, 36	90		\$2,095	\$2,286	\$2,834
38, 310, 40	90		\$2,196	\$2,386	\$2,940

**NOTE: This product is manufactured offsite and ship separately.
Call to verify lead-times, freight cost, and ship schedule**

STANDARD DESCRIPTION

Steel stiffened core filled with Fiberglass with an "A" edge bevel and exposed seam "S" edge are standard "T" edge is standard on 14 ga.

1 3/4" thick doors with 22 gauge stiffeners welded to core plate

EDGE BEVELS AVAILABLE

"A" standard (1/8" in 2" lock edge-square hinge edge only) No Add

Galvanneal Steel (A40 & A60)

		<u>A40</u>	<u>A60</u>
a) 68 HEIGHT	Add	\$48	\$97
b) 70 HEIGHT	Add	\$48	\$103
c) 72 HEIGHT	Add	\$48	\$111
d) 80 HEIGHT	Add	\$48	\$118
e) 90 HEIGHT	Add	\$56	\$124

Galvanized (G90) includes epoxy primer

a) 68 HEIGHT	Add	\$354
b) 70 HEIGHT	Add	\$361
c) 72 HEIGHT	Add	\$367
d) 80 HEIGHT	Add	\$373
e) 90 HEIGHT	Add	\$382

"N" seamless edge filled	Add	\$89
"T" Continuous wire welded - 18 & 16 ga.only	Add	\$143
Visual ID tag	Add	\$6

LISTED FIRE LABEL DOORS (Prices are without closer CL): **LESS CL**

Underwriters Laboratories	BCG	Add	\$65
Underwriters Laboratories	A	Add	\$99
Warnock Hersey	BCG	Add	\$17
Warnock Hersey	A	Add	\$52
20 minute U .L . or W .H .I .		Add	\$17
Label construction		Add	\$24

Fire Rating = 4080 max

NON STANDARD SIZE DOORS

Price as the next largest standard size door

EXTRAS

ASTRAGALS

Z type blank screw applied	Z1	Add	\$96
Z type with strike E1 screw applied	Z1E1	Add	\$159
Z type with strike and flush bolt screw applied	Z1/E1/H1	Add	\$246
Flat astragal screw applied		Add	\$88

CAPS — top or bottom

Steel installed flush (with screws per cap)		Add	\$26
---	--	-----	------

CLOSER

Surface mounted, reinforcement only		Add	\$36
Concealed or semi-concealed		Add	\$313
DUTCH DOOR (SHELF EXTRA)		Add	\$358

FLUSH BOLTS OR SURFACE BOLTS

Top and bottom flush bolt ANSI A115.4 (when used without astragal or with flat bar astragal)	H1	Add	\$87
Top and bottom surface bolt reinforced only	SB	Add	\$61

HINGE PREPARATIONS

4 1/2" standard or heavyweight		Standard	
5" Hinge standard or heavyweight	Add Each	\$9	
1 1/2 pair up to and including 7'6"		Standard	
2 pair over 7'6" to 10'0"		Standard	
Anchor hinge set (e.g. McKinney TA792) No drill, no tap (e.g. McKinney TA793)		Add	\$203
Continuous hinge preparation(mounting holes field drilled)		No Add	
Concealed mounting (e.g. McKinney 11, 24)		No Add	
Surface mounting (e.g. McKinney 21, 53)		Add	\$108

LOCK PREPARATIONS

Cylindrical lock - 161	G2	Standard	
Cylindrical lock - lever trim holes (Universal lever trim prep .)	G2B*	Standard	
Deadlock - tubular 181	G16	Standard	
Deadlock - mortise 190	G17	Add	\$87
Interconnected lock	G25	Add	\$58

EXTRAS

LOCK PREPARATIONS CONTINUED

Mortise lock - Escutcheon Trim	G3	Standard	
Mortise lock - Sectional Trim	G3A*	Standard	
Hotel and master ring cylinder	**G3A	Standard	
Mortise lock edge only preparation	G3AEO	Standard	
Mortise lock reinforce only	G3ARO	Standard	
Mortise panic exit	G12*	Add	\$87
Rim panic reinforce only	G11	Add	\$46
Rim panic reinforce with function holes	G11*	Add	\$46
Rim vertical rod reinforce only	G11A	Add	\$87
Rim vertical rod with function holes	G11A*	Add	\$87
Concealed vertical rods	G12A*	Add	\$578
Low profile vertical rod	G12B	Add	\$578
Recessed vertical rod	G13C	Add	\$578
Mortise panic ctr & bottom latch	G14C	Add	\$141
Label Fire Pin (if required)		Add	\$30

LOUVERS

Louver cutout only		Add	\$81
Louver cutout surround with channel (label louver requirement)		Add	\$142

STRIKES

4 7/8" ANSI lipped strike	E1	Add	\$63
2 3/4" ANSI lipped strike	E2	Add	\$63
3 1/2" ANSI deadlock strike	E3	Add	\$63
2 3/4" ANSI deadlock strike	E4	Add	\$63
Electric Strike	E9*	Add	\$143
Electric raceway		Add	\$166
Open back strike	*	Add	\$143

*Advise of manufacturer and function of hardware

UNDERCUTS

5/8" standard, 3/8", 3/4" available		No Add	
All other undercuts per door		Add	\$24

VISION KITS - Type 9 Standard - surround channel included

Vision kits installed (3/8" pocket) standard rim type kit			
FV		Add	\$289
FNV		Add	\$316
HG		Add	\$359
FG		Add	\$481
FL cutout only		Add	\$81

777SE Series Doors - Trio-E Steel Stiffened-Polyurethane Filled Flush Door Prices

May, 2024



WIDTH	HEIGHT	18 ga	16 ga	14 ga
20, 24, 26, 28 .210, 30	68	\$1,153	\$1,283	\$1,778
34, 36	68	\$1,338	\$1,467	\$1,963
38, 310, 40	68	\$1,451	\$1,580	\$2,076
20, 24, 26, 28 .210, 30	70	\$1,175	\$1,312	\$1,815
34, 36	70	\$1,370	\$1,506	\$2,009
38, 310, 40	70	\$1,489	\$1,627	\$2,130
20, 24, 26, 28 .210, 30	72	\$1,257	\$1,402	\$1,914
34, 36	72	\$1,409	\$1,554	\$2,066
38, 310, 40	72	\$1,520	\$1,666	\$2,177
20, 24, 26, 28 .210, 30	80	\$1,510	\$1,665	\$2,182
34, 36	80	\$1,657	\$1,811	\$2,328
38, 310, 40	80	\$1,770	\$1,924	\$2,442
30	90	\$1,999	\$2,165	\$2,687
34, 36	90	\$2,219	\$2,385	\$2,908
38, 310, 40	90	\$2,357	\$2,524	\$3,047

**NOTE: This product is manufactured offsite and ship separately.
Call to verify lead-times, freight cost, and ship schedule**

STANDARD DESCRIPTION

Steel stiffened core filled with Polyurethane foam with an "A" edge bevel and exposed seam "S" edge are standard "T" edge is standard on 14 ga.
1 3/4" thick doors with 22 gauge stiffeners welded to core plate

EDGE BEVELS AVAILABLE

"A" standard (1/8" in 2" lock edge-square hinge edge only) No Add

Galvanneal Steel (A40 & A60)

		<u>A40</u>	<u>A60</u>
a) 68 HEIGHT	Add	\$48	\$97
b) 70 HEIGHT	Add	\$48	\$103
c) 72 HEIGHT	Add	\$48	\$111
d) 80 HEIGHT	Add	\$48	\$118
e) 90 HEIGHT	Add	\$56	\$124

Galvanized (G90) includes epoxy primer

a) 68 HEIGHT	Add	\$354
b) 70 HEIGHT	Add	\$361
c) 72 HEIGHT	Add	\$367
d) 80 HEIGHT	Add	\$373
e) 90 HEIGHT	Add	\$382

"N" seamless edge filled	Add	\$89
"T" Continuous wire welded - 18 & 16 ga. only	Add	\$143
Visual ID tag	Add	\$6

LISTED FIRE LABEL DOORS (Prices are without closer CL):

		LESS
		CL
Underwriters Laboratories	BCG	Add \$65
Underwriters Laboratories	A	Add \$99
Warnock Hersey	BCG	Add \$17
20 minute U .L . or W .H .I .		Add \$17
Label construction		Add \$24

Fire Rating = 4080 max

NON STANDARD SIZE DOORS

Price as the next largest standard size door

EXTRAS

ASTRAGALS

Z type blank screw applied	Z1	Add	\$96
Z type with strike E1 screw applied	Z1E1	Add	\$159
Z type with strike and flush bolt screw applied	Z1/E1/H1	Add	\$246
Flat astragal screw applied		Add	\$88

CAPS — top or bottom

Steel installed flush (with screws per cap)		Add	\$26
---	--	-----	------

CLOSER

Surface mounted, reinforcement only		Add	\$36
Concealed or semi-concealed		Add	\$313

DUTCH DOOR (SHELF EXTRA)

	Add	\$358
--	-----	-------

FLUSH BOLTS OR SURFACE BOLTS

Top and bottom flush bolt ANSI A115.4 (when used without astragal or with flat bar astragal)	H1	Add	\$87
Top and bottom surface bolt reinforced only	SB	Add	\$61

HINGE PREPARATIONS

4 1/2" standard or heavyweight		Standard	
5" Hinge standard or heavyweight		Add Each	\$9
1 1/2 pair up to and including 7'6"		Standard	
2 pair over 7'6" to 10'0"		Standard	
Anchor hinge set (e.g. McKinney TA792) No drill, no tap (e.g. McKinney TA793)		Add	\$203
		No Add	
Continuous hinge preparation(mounting holes field drilled)			
Concealed mounting (e.g. McKinney 11, 24)		No Add	
Surface mounting (e.g. McKinney 21, 53)		Add	\$108

LOCK PREPARATIONS

Cylindrical lock - 161	G2	Standard	
Cylindrical lock - lever trim holes (Universal lever trim prep .)	G2B*	Standard	
Deadlock - tubular 181	G16	Standard	
Deadlock - mortise 190	G17	Add	\$87
Interconnected lock	G25	Add	\$58

EXTRAS

LOCK PREPARATIONS CONTINUED

Mortise lock Escutcheon Trim	G3	Standard	
Mortise lock - Sectional Trim	G3A*	Standard	
Hotel and master ring cylinder functions	**G3A	Standard	
Mortise lock edge only preparation	G3AEO	Standard	
Mortise lock reinforce only	G3ARO	Standard	
Mortise panic exit	G12*	Add	\$87
Rim panic reinforce only	G11	Add	\$46
Rim panic reinforce with function holes	G11*	Add	\$46
Rim vertical rod reinforce only	G11A	Add	\$87
Rim vertical rod with function holes	G11A*	Add	\$87
Concealed vertical rods	G12A*	Add	\$578
Low profile vertical rod	G12B	Add	\$578
Recessed vertical rod	G13C	Add	\$578
Mortise panic ctr & bottom latch	G14C	Add	\$141
Label Fire Pin (if required)		Add	\$30

LOUVERS

Louver cutout only		Add	\$81
Louver cutout surround with channel (label louver requirement)		Add	\$142

STRIKES

4 7/8" ANSI lipped strike	E1	Add	\$63
2 3/4" ANSI lipped strike	E2	Add	\$63
3 1/2" ANSI deadlock strike	E3	Add	\$63
2 3/4" ANSI deadlock strike	E4	Add	\$63
Electric Strike	E9*	Add	\$143
Electric raceway		Add	\$166
Open back strike	*	Add	\$143

*Advise of manufacturer and function of hardware

UNDERCUTS

5/8" standard, 3/8", 3/4" available	No Add
All other undercuts per door	Add \$24

VISION KITS-Type 9 Standard -surround channel included

Vision kits installed (3/8" pocket) standard rim type kit		
FV	Add	\$289
FNV	Add	\$316
HG	Add	\$359
FG	Add	\$481
FL cutout only	Add	\$81

847S Series Doors

Flush Door Prices

May, 2024



WIDTH	HEIGHT				14 ga
20, 24, 26, 28 .210, 30	68				\$2,342
34, 36	68				\$2,649
38, 310, 40	68				\$2,801
20, 24, 26, 28 .210, 30	70				\$2,384
34, 36	70				\$2,685
38, 310, 40	70				\$2,853
20, 24, 26, 28 .210, 30	72				\$2,498
34, 36	72				\$2,757
38, 310, 40	72				\$2,903
30	80				\$2,806
34, 36	80				\$3,030
38, 310, 40	80				\$3,155
30	90				\$3,531
34, 36	90				\$3,725
38, 310, 40	90				\$3,809
30	100				\$3,916
34, 36	100				\$4,091
38, 310, 40	100				\$4,170

OVERSIZED DOOR OPTIONS

Doors over 4' wide and 8' high are factory crated for protection in transit
 Larger door sizes are available for 847 series - contact factory for quote.

STANDARD DESCRIPTION

Steel stiffened core with an "G" edge bevel and exposed seam "S" edge are standard
 Insulated with one pound density fiberglass
 1 3/4" thick doors and 18 gauge stiffeners
 Stiffeners are 4" center line with 4" weld centers on face.
 Welded flush top channel standard

EDGE BEVELS AVAILABLE

"G" (1/8" in 2" bevel both edges) Standard

Galvanneal Steel (A40 & A60)

		<u>A40</u>	<u>A60</u>
a) 68 HEIGHT	Add	\$48	\$97
b) 70 HEIGHT	Add	\$48	\$103
c) 72 HEIGHT	Add	\$48	\$111
d) 80 HEIGHT	Add	\$48	\$118
e) 90 HEIGHT	Add	\$56	\$124
f) 100 HEIGHT	Add	\$56	\$131

Galvanized (G90) includes epoxy primer

a) 68 HEIGHT	Add	\$354
b) 70 HEIGHT	Add	\$361
c) 72 HEIGHT	Add	\$367
d) 80 HEIGHT	Add	\$373
e) 90 HEIGHT	Add	\$382
f) 100 HEIGHT	Add	\$395

"N" seamless edge filled	Add	\$89
"T" Continuous wire welded	Add	\$143
Visual ID tag	Add	\$6

LISTED FIRE LABEL DOORS (Prices are without closer CL): LESS CL

Underwriters Laboratories	ABCG	\$65
Warnock Hersey	ABCG	\$17
20 minute U.L. or W.H.I.		\$17
Label construction		\$24

NON STANDARD SIZE DOORS

Price as the next largest standard size door

EXTRAS

ASTRAGALS

Z type blank screw applied	Z1	Add	\$96
Z type with strike E1 screw applied	Z1E1	Add	\$159
Z type with strike and flush bolt screw applied	Z1/E1/H1	Add	\$246
Flat astragal screw applied		Add	\$88

CAPS — top cap welded flush

Bottom cap installed with screws		Standard	
Bottom cap welded flush		Add	\$26
		Add	\$46

CLOSER

Surface mounted, reinforcement only		Add	\$36
Concealed or semi-concealed		Add	\$313

DUTCH DOOR (SHELF EXTRA)

	Add	\$358
--	-----	-------

FLUSH BOLTS OR SURFACE BOLTS

Top and bottom flush bolt ANSI A115.4 (when used without astragal or with flat bar astragal)	H1	Add	\$87
Top and bottom surface bolt reinforced only	SB	Add	\$61

HINGE PREPARATIONS

4 1/2" standard or heavyweight		Standard	
5" Hinge standard or heavyweight		Add Each	\$9
1 1/2 pair up to and including 7'6"		Standard	
2 pair over 7'6" to 10'0"		Standard	
Anchor hinge set (e.g. McKinney TA792) No drill, no tap (e.g. McKinney TA793)		Add	\$203
	No Add		
Continuous hinge preparation(mounting holes field drilled)		No Add	
Concealed mounting (e.g. McKinney 11, 24)		No Add	
12 gauge hinge rail standard		No Add	
Surface mounting (e.g. McKinney 21, 53)		Add	\$108

LOCK PREPARATIONS

Cylindrical lock - 161	G2	Standard	
Cylindrical lock - lever trim (Universal lever trim prep .)	G2B*	Standard	
Deadlock - tubular 181	G16	Standard	
Deadlock - mortise 190	G17	Add	\$87

EXTRAS

LOCK PREPARATIONS CONTINUED

Mortise lock - Escutcheon Trim	G3	Standard	
Mortise lock - Sectional Trim	G3A*	Standard	
Hotel and master ring cylinder functions	**G3A	Standard	
Mortise lock edge only preparation	G3AEO	Standard	
Mortise lock reinforce only	G3ARO	Standard	
Mortise panic exit	G12*	Add	\$87
Rim panic reinforce only	G11	Add	\$46
Rim panic reinforce with function holes	G11*	Add	\$46
Rim vertical rod reinforce only	G11A	Add	\$87
Rim vertical rod with function holes	G11A*	Add	\$87
Concealed vertical rods	G12A*	Add	\$578
Label Fire Pin (if required)		Add	\$30

LOUVERS

Louver cutout only		Add	\$81
Louver cutout surround with channel (label louver requirement)		Add	\$142

STRIKES

4 7/8" ANSI lipped strike	E1	Add	\$63
2 3/4" ANSI lipped strike	E2	Add	\$63
3 1/2" ANSI deadlock strike	E3	Add	\$63
2 3/4" ANSI deadlock strike	E4	Add	\$63
Electric Strike	E9*	Add	\$143
Electric raceway		Add	\$166
Open back strike	*	Add	\$143

*Advise of manufacturer and function of hardware

UNDERCUTS

5/8" standard, 3/8", 3/4" available		No Add	
All other undercuts per door		Add	\$24

VISION KITS-Type 9 Standard -surround channel included

Vision kits installed (3/8" pocket) standard rim type kit			
FV		Add	\$289
FNV		Add	\$316
HG		Add	\$359
FG		Add	\$481
FL cutout only		Add	\$81

NOTE: For additional window options refer to the Engineered Door Section.

857S Series Doors - 2" Steel Stiffened Flush Door Prices

May, 2024



WIDTH	HEIGHT				14 ga
20, 24, 26, 28, 10, 30	68				\$2,820
34, 36	68				\$3,043
38, 310, 40	68				\$3,218
20, 24, 26, 28, 210, 30	70				\$2,848
34, 36	70				\$3,087
38, 310, 40	70				\$3,280
20, 24, 26, 28, 210, 30	72				\$2,871
34, 36	72				\$3,167
38, 310, 40	72				\$3,333
30	80				\$3,225
34, 36	80				\$3,482
38, 310, 40	80				\$3,624

OVERSIZED DOOR OPTIONS

Larger door sizes are available for 857 series - contact factory for quote.

STANDARD DESCRIPTION

Steel stiffened core with an "G" edge bevel and exposed seam "S" edge are standard Insulated with one pound density fiberglass

2" thick doors with 18 gauge stiffeners for use with 2-3/16" frame rabbet complies with Commercial Security Hollow Metal Specification HMMA-862-87 When supplied "T" Welded Edge. Welded Flush Top Channel Standard

EDGE BEVELS AVAILABLE

"A" standard (1/8" in 2" lock edge-square hinge edge) No Add

"B" specify (Square both edges) No Add

NOTE: For other edge bevels refer to Engineered Door Section

Galvanneal Steel (A40 & A60)

		<u>A40</u>	<u>A60</u>
a) 68 HEIGHT	Add	\$48	\$97
b) 70 HEIGHT	Add	\$48	\$103
c) 72 HEIGHT	Add	\$48	\$111
d) 80 HEIGHT	Add	\$48	\$118

"N" seamless edge filled	Add	\$89
"T" Continuous wire welded	Add	\$143
Visual ID tag	Add	\$6

LISTED FIRE LABEL DOORS (Prices are without closer CL):

		LESS CL
Underwriters Laboratories	ABCG Add	\$65
Warnock Hersey	ABCG Add	\$17
20 minute U.L. or W.H.I.	Add	\$17
Label construction	Add	\$24

NON STANDARD SIZE DOORS

Price as the next largest standard size door

EXTRAS

ASTRAGALS

Z type blank screw applied	Z1	Add \$96
Z type with strike E1 screw applied	Z1E1	Add \$159
Z type with strike and flush bolt screw applied	Z1/E1/H1	Add \$246
Flat astragal screw applied		Add \$88

CAPS — topcap welded flush

Bottom cap installed with screws		Add \$26
Bottom cap welded flush		Add \$46

CLOSER

Surface mounted, reinforcement only		Add \$36
Concealed or semi-concealed		Add \$313

DUTCH DOOR (SHELF EXTRA)

Add \$358

FLUSH BOLTS OR SURFACE BOLTS

Top and bottom flush bolt ANSI A115.4 (when used without astragal or with flat bar astragal)	H1	Add \$87
Top and bottom surface bolt reinforced only	SB	Add \$61

HINGE PREPARATIONS

4 1/2" standard or heavyweight		Standard
5" Hinge standard or heavyweight		Add Each \$9
1 1/2 pair up to and including 7'6"		Standard
2 pair over 7'6" to 10'0"		Standard
Anchor hinge set (e.g. McKinney TA792) No drill, no tap (e.g. McKinney TA793)		Add \$203 No Add
Continuous hinge preparation(mounting holes field drilled) Concealed mounting (e.g. McKinney 11, 24)		No Add
12 gauge hinge rail standard Surface mounting (e.g. McKinney 21, 53)		No Add Add \$108

LOCK PREPARATIONS

Cylindrical lock 2" door 161	G2	Standard
Cylindrical lock 2" door lever trim (Universal lever trim prep.)	G2B*	Standard
Deadlock 2" door tubular 181	G16	Standard
Deadlock 2" door mortise 190	G17	Add \$87
Interconnected lock	G25	Add \$58

EXTRAS

LOCK PREPARATIONS CONTINUED

Mortise lock 2" door escutcheon trim	G3	Standard
Mortise lock 2" door sectional trim	G3A*	Standard
Hotel and master ring cylinder	**G3A	Standard
Mortise lock edge only preparation	G3AEO	Standard
Mortise lock reinforce only	G3ARO	Standard
Mortise panic exit	G12*	Add \$87
Rim panic reinforce only	G11	Add \$46
Rim panic reinforce with function holes	G11*	Add \$46
Rim vertical rod reinforce only	G11A	Add \$87
Rim vertical rod with function holes	G11A*	Add \$87
Concealed vertical rods	G12A*	Add \$578
Label Fire Pin (if required)		Add \$30

LOUVERS

Louver cutout only		Add \$81
Louver cutout surround with channel (label louver requirement)		Add \$142

STRIKES

4 7/8" ANSI lipped strike	E1	Add \$63
2 3/4" ANSI lipped strike	E2	Add \$63
3 1/2" ANSI deadlock strike	E3	Add \$63
2 3/4" ANSI deadlock strike	E4	Add \$63
Electric Strike	E9*	Add \$143
Electric raceway		Add \$166
Open back strike	*	Add \$143

*Advise of manufacturer and function of hardware

UNDERCUTS

2" doors - 5/8" standard, 3/8", 3/4" available	No Add
All other undercuts per door	Add \$24

VISION KITS-Type 3,4, 7, or 8

Vision kits installed, add per type and size

	TYPE 3	TYPE 4	TYPE 7	TYPE 8
FV	\$311	\$497	\$512	\$512
FNV	\$354	\$540	\$594	\$594
HG	\$419	\$605	\$726	\$726
FG	\$683	\$869	\$1,151	\$1,151

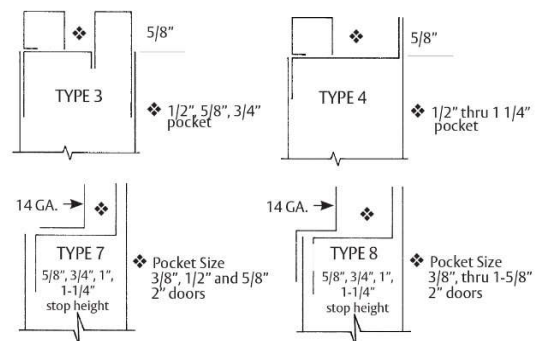

30 757 Series Doors-Steel Sound Resistant (STC)

STC Flush Door Prices

May, 2024



UP TO STC 41 (Model AS41P)

WIDTH	HEIGHT	18 GA	16 GA	14 GA
20, 24, 26, 28, 210, 30	68	\$2,317	\$2,425	\$2,891
34, 36	68	\$2,496	\$2,604	\$3,068
38, 310, 40	68	\$2,611	\$2,719	\$3,182
20, 24, 26, 28, 210, 30	70	\$2,334	\$2,444	\$2,908
34, 36	70	\$2,514	\$2,623	\$3,087
38, 310, 40	70	\$2,631	\$2,739	\$3,204
20, 24, 26, 28, 210, 30	72	\$2,373	\$2,481	\$2,946
34, 36	72	\$2,534	\$2,642	\$3,109
38, 310, 40	72	\$2,655	\$2,763	\$3,229
30	80	\$2,585	\$2,693	\$3,158
34, 36	80	\$2,755	\$2,863	\$3,329
38, 310, 40	80	\$2,863	\$2,971	\$3,438
30	90	\$3,070	\$3,178	\$3,642
34, 36	90	\$3,245	\$3,353	\$3,825
38, 310, 40	90	\$3,420	\$3,529	\$4,007

STANDARD DESCRIPTION

Proprietary core with an "A" edge bevel and exposed seam "S" edge is standard. 3/8" bottom undercut required. 1 3/4" thick door. Frames priced separately. STC label applied to door only. Threshold and seal package included in door price and drop shipped direct from vendor. STC label included with door. CAM hinges included at ADJ frames.

EDGE BEVELS AVAILABLE

		No Add	
		<u>A40</u>	<u>A60</u>
A standard (1/8" in 2" lock edge-square hinge edge)			
Galvanneal Steel (A40 & A60)			
a) 68 HEIGHT	Add	\$48	\$97
b) 70 HEIGHT	Add	\$48	\$103
c) 72 HEIGHT	Add	\$48	\$111
d) 80 HEIGHT	Add	\$48	\$118
e) 90 HEIGHT	Add	\$56	\$124

Galvanized (G90) includes epoxy primer

a) 68 HEIGHT	Add	\$354
b) 70 HEIGHT	Add	\$361
c) 72 HEIGHT	Add	\$367
d) 80 HEIGHT	Add	\$373
e) 90 HEIGHT	Add	\$382
"N" Seamless edge filled	Add	\$89
"T" Continuous wire welded	Add	\$143

LESS CL

Underwriters Laboratories	Add	\$65
Intertek (Warnock Hersey)	Add	\$17

EMBOSSED DOORS (M frame not included)

6 Panel - 18, 16 ga. A40-2868 to 3070-up to STC 4	E6	Add	\$540
2 Panel-18 ga. A40-2868 to 3080-up to STC 47	2P, 2PA, 2PAP	Add	\$540

STC RATINGS

Up to STC41 (Model AS41P)	No Add
Pemko seal system included. M frame required - price separately	
STC42-46 (Model AS46P)	Add \$658
Pemko seal system included. M frame required - price separately	
STC47-49 (Model AS49P)	Factory Quoted
Pemko seal system included. M frame required - price separately	
STC50-52 (Model AS52P)	Factory Quoted
Pemko seal system included. M frame required - price separately	
STC53-54 (Model AS54C)	Factory Quoted
Compression seal system included. ADJ frame required - price separate	
STC55 (14 ga not available) (Model AS55P)	Factory Quoted
Pemko seal system continuous hinge included-ST frame not included	
STC56-66 (14 ga not available) (Model AS66C)	Factory Quoted
Compression seal system included. ADJ frame required - price separately	
CAM SEAL SYSTEM IN LIEU OF PEMKO SEAL SYSTEM (up to STC52)	
Compression seal system included. ADJ frame required - price separately	Factory Quoted

NOTES:

1. STC 55 maximum 80 height. 18 and 16 ga only
2. STC 56-66 price includes two doors.
3. GLASS LITES - Refer to the Tech Data Manual for glass lite availability per rating. Contact factory for pricing.
4. Prices are per door. For pairs, refer to the Tech Data Manual for availability per rating.
5. Doors are crated for shipment. Larger orders are normally shipped 10 doors per crate. Additional shipping costs may apply

LISTED FIRE LABEL DOORS

Label door restrictions per gauge and size can be determined in the current product brochure

NON STANDARD SIZE DOORS

Price as the next largest standard size door

For faster quote turnaround, please use QQF (Quick Quote Forms) Located on Connect.

All embossed doors, doors over STC 49 and all doors with glass lites greater than 180 sq in. are manufactured offsite.

**757S Series Doors - Sound Resistant (STC)
 STC Flush Door Prices**

May, 2024

EXTRAS			
ASTRAGALS			
Flat astragal tack welded (pair only)		Add	\$111
CLOSER			
Surface mounted, reinforcement only		Add	\$36
FLUSH BOLTS OR SURFACE BOLTS			
Top and bottom flush bolt ANSI A115.4 (when used without astragal or with flat bar astragal)	H1	Add	\$87
Top and bottom surface bolt reinforced only	SB	Add	\$61
HINGE PREPARATIONS			
4 1/2" standard or heavyweight		Standard	
5" Hinge standard or heavyweight		Add Each	\$9
1 1/2 pair up to and including 7'6"		Standard	
2 pair over 7'6" to 10'0"		Standard	
Anchor hinge set			
(e.g. McKinney TA792) No drill, no tap		Add	\$203
(e.g. McKinney TA793)		No Add	
Continuous hinge preparation (mounting holes field drilled)			
Concealed mounting		No Add	
(e.g. McKinney - 11, 24)			
12 gauge hinge rail available (Specify)		No Add	
Surface mounting			
(e.g. McKinney-21, 53)		Add	\$108
LOCK PREPARATIONS			
Cylindrical lock 1-3/4" door 161	G2	Standard	
Cylindrical lock 1-3/4" door lever trim (Universal lever trim prep)	G2B*	Standard	
Deadlock 1 3/4" door tubular 181	G16	Standard	
Deadlock 1 3/4" door mortise 190	G17	Add	\$87

EXTRAS			
LOCK PREPARATIONS CONTINUED			
Mortise lock 1 3/4" door escutcheon trim	G3	Standard	
Mortise lock 1 3/4" door sectional trim	G3A*	Standard	
Hotel and master ring cylinder functions	**G3A	Standard	
Mortise lock edge only preparation	G3AEO	Standard	
Mortise lock reinforce only	G3ARO	Standard	
Mortise panic exit	G12*	Add	\$87
Rim panic reinforce only	G11	Add	\$46
Rim panic reinforce with function holes	G11*	Add	\$46
Rim vertical rod reinforce only	G11A	Add	\$87
Rim vertical rod with function holes	G11A*	Add	\$87
STRIKES			
4 7/8" ANSI lipped strike 1 3/4" door	E1	Add	\$63
2 3/4" ANSI lipped strike 1 3/4" door	E2	Add	\$63
3 1/2" ANSI deadlock strike	E3	Add	\$63
2 3/4" ANSI deadlock strike	E4	Add	\$63
Electric strike	E9*	Add	\$143
Electric raceway		Add	\$166
Open back strike non label door	*	Add	\$143
*Advise of manufacturer and function of hardware.			
UNDERCUTS			
1 3/4" doors - 3/8" standard, 5/8", 3/4" available		No Add	
STC 56-66 - 7/8" standard		No Add	
All other undercuts per door		Add	\$24
VISION KITS - NON RATED			
Vision kits installed- glass included			
FV		Add	\$1,714
FNV		Add	\$1,714
HG		Add	\$2,142
FG		Add	\$3,216
Not available on embossed doors			
VISION KITS-FIRE RATED			
Vision kits installed- glass included			
FV		Add	\$4,287
FNV		Add	\$4,287
HG		Add	\$5,539
FG		Add	\$8,141
Not available on embossed doors			

DESCRIPTION	PAGE
Masonry	
M-18 KD — Masonry Flush Frames and Components	
General Informaiton & Extras	2
Extras Continued	3
M-16 KD — Masonry Flush Frames and Components	
General Information and Extras	4
Extras Continued	5
M-14 KD — Masonry Flush Frames and Components	
General Information and Extras	6
Extras Continued	7
M-12 SMO — Masonry Flush Frames and Components	
General Information and Extras	8
Extras Continued	9
Masonry Borrowed Lites	
M-16 KD	10
M-14 KD	11
Drywall	
C-18 KD — Drywall Frames and Components	
General Information and Extras	12
Extras Continued	13
C-16 KD — Drywall Frames and Components	
General Information and Extras	14
Extras Continued	15
C-16 KD SideLight Frames	
General Information and Extras	16
Extras Continued	17
C-14 KD — Drywall Frames and Components	
General Information and Extras	18
Extras Continued	19
Drywall Borrowed Lites	
C-16 KD	20
C-14 KD	21
Masonry / Drywall	
CM-18 KD — Drywall/Masonry Frames and Components	
General Information and Extras	22
Extras Continued	23
CM-16 KD — Drywall/Masonry Frames and Components	
General Information and Extras	24
Extras Continued	25
CM-14 KD — Drywall/Masonry Frames and Components	
General Information and Extras	26
Extras Continued	27
STC ADJ Series Frames	28-29
E119 Fire Resistive Frames	30-31

M-18 KD Frames

Frame Prices

May, 2024



	WIDTH	HEIGHT	5-3/4	3 THRU 6	6-1/8 THRU 7-7/8	8 THRU 9-7/8
SINGLES	1'6" THRU 3'0"	6'8"	\$225	\$237	\$272	\$320
		7'	\$230	\$243	\$277	\$325
		7'2"	\$247	\$260	\$294	\$342
	3' + THRU 4'0"	8'	\$283	\$296	\$330	\$378
		6'8"	\$237	\$250	\$285	\$333
		7'	\$242	\$256	\$290	\$338
DOUBLES	4' + THRU 6'0"	7'2"	\$259	\$273	\$307	\$355
		8'	\$295	\$309	\$343	\$391
		6'8"	\$288	\$301	\$334	\$397
		7'	\$292	\$307	\$342	\$401
	6' + THRU 8'0"	7'2"	\$306	\$319	\$356	\$417
		8'	\$356	\$371	\$404	\$465
		6'8"	\$311	\$324	\$357	\$419
		7'	\$315	\$330	\$365	\$423
FRAME COMPONENT PART PRICES (NO ANCHORS)						
STRIKE JAMBS	6'8"	\$76	\$81	\$96	\$115	
	7'	\$79	\$84	\$97	\$118	
	7'2"	\$89	\$95	\$107	\$127	
	8'	\$97	\$102	\$116	\$136	
HINGE JAMBS	6'8"	\$89	\$94	\$107	\$127	
	7'	\$91	\$97	\$111	\$129	
	7'2"	\$98	\$103	\$118	\$137	
	8'	\$120	\$126	\$139	\$158	
HEADS	1'6" THRU 3'0"	\$42	\$44	\$51	\$60	
	3'+ THRU 4'0"	\$54	\$57	\$64	\$73	
	4'+ THRU 6'0"	\$92	\$95	\$102	\$125	
	6'+ THRU 8'0"	\$115	\$118	\$125	\$147	

GENERAL INFORMATION

CURRIES M series frames are available double rabbet (equal or unequal) single rabbet, cased opening, nailer frame, or double egress profile. Prices reflect hardware preparations for 1 3/4" doors. Refer to CURRIES Architectural Technical Data Manual for standard details and limitations.

EXPANDED KD CAPABILITIES

- 2" Face unequal rabbet profiles are standard.
- Identical profile jambs and heads 1" face through 2" face in 1/8" increments are now available KD, M, G, NM, and MK profile.
- Identical profile jambs and heads are available 2-1/8" face through 4" face in 1/8" increments KD, in M, G, N, and MK profile. Add 25% to the 2" face frame base price (i.e.: faces may be unequal, 1-1/2" face door side and 3-1/4" face opposite, but identical profile, jambs to head).
- Returns can vary 7/16" minimum through 1" maximum. Add 15%.
- Rabbets can vary 5/8" minimum and 6" maximum for the non door rabbet.

Contact factory for bend limitations on any KD profiles with rabbets exceeding 6". A 15% add is applicable to frame price for returns and or rabbets. Jamb depth ranges are listed above each column. 1/8" increment jamb depths (all ranges 3" thru 9-7/8") are available at no extra charge.

ANCHORS - foot clips are welded in place.

Standard loose jamb anchors are included in these prices; 3 per jamb up to 7'6" and 4 per jamb over 7'6".

Complete anchor information is listed in the Engineered Frame Section.

Welding charge only per anchor Add \$3
 (Add for appropriate anchor)

EXTRAS

BUNDLING AND TAGGING FRAMES

Frame Order Code 3F, 3FH, 3FV, 2F, SL, BL, 4F
 component bundling or welded frames Add \$6
 Visual ID tags Add \$6

CASED OPENING FRAMES (4 1/2" - 9 7/8") MK

Per frame Add \$18
 Per piece Add \$6

Cased opening price includes standard mortise hardware preparations, hinges and strikes or blank.

COMMUNICATING FRAME (4 7/8" - 9 7/8")

Available for 1 3/4" doors N/C

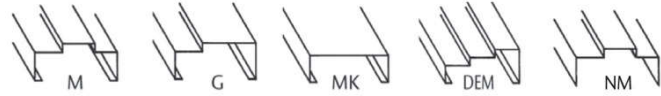

		EXTRAS	
CURRISEAL FRAME (4 1/8" - 14")			
Gasketed frame price includes gasket.			
Available for 1 3/4" door			
Maximum size 4080 / 8080		Add	\$174
Head		Add	\$58
Jamb		Add	\$58
Additional gasket prices and stock numbers are listed in the Engineered Frame Section.			
DOUBLE EGRESS (4 3/4" - 9 7/8")			
Available for 1 3/4" doors			
Per frame		Add	\$583
Per hinge jamb		Add	\$146
Per splice welded head		Add	\$291
Anchors in head required for fire rating			
DUTCH DOOR FRAME			N/C
FOUR (4") INCH FACE HEADS (4-3/4" - 9-7/8") JAMB DEPTH			
Available for 1 3/4" doors			
Single including 4'0"		Add	\$57
Pairs over 4'0"		Add	\$80
GALVANNEAL (A40 & A60) FRAME ADDS			
		A40	A60
Price per frame piece	Add	\$10	\$18
Price per 3-Sided frame	Add	\$30	\$54
Double egress	Add		\$71
GALVANIZED (G-90)			
Price per frame piece	Add	\$31	
Price per 3 sided frame	Add	\$93	
Double egress	Add	\$124	
FIRE FRAME LABELS			
Warnock Hersey - Specify on order			
Embossment; no hourly or 1-1/2 hour rating		Standard	
Metal label with hourly rating on hinge jamb		Add	\$29

		EXTRAS	
THERMAL BREAK FRAMES - NOT AVAILABLE			
HARDWARE PREPARATIONS			
CLOSER PREPARATIONS			
Concealed closer			Add \$267
Regular arm	E10	Add	\$30
Parallel arm	E11	Add	\$30
Half sleeve	E18	Add	\$38
Full sleeve	E17	Add	\$46
FLUSH BOLTS			
Standard ANSI 115.4	H2	Add	\$53
Reversible (strike plate included)	H5	Add	\$53
reinforce only	H1	Add	\$30
HINGE BEDDATIONS			
3 1/2" 1 pair or 1 1/2 pair		Standard	
4 1/2" standard or heavyweight		Standard	
1 1/2 pair up to and including 7'6"		Standard	
2 pair over 7'6" to 8'0"		Standard	
5" standard or heavyweight	Add Ea	\$9	
Full surface mounted continuous hinge reinforcement		Add	\$80
High frequency reinforcement strap support			
Per hinge		Add	\$24
HOLDERS			
Overhead concealed		Add	\$158
Overhead stop & holder surface mounted 14 ga		Add	\$30
PIVOTS			
Top & bottom set single acting	Per frame	Add	\$248
	Per jamb	Add	\$103
	Per jead	Add	\$145
Intermediate pivot single acting	Eacj	Add	\$87
PANIC EXIT REINFORCING			
Rim Type	E8	Add	\$30
Rim vertical rod surface mounted strike	E5	Add	\$30
Vertical rod mortise strike in head - Each	G20	Add	\$65
STRIKES			
4 7/8" ANSI lipped strike	E1	Standard	
2 3/4" ANSI lipped strike	E2	Standard	
3 1/2" ANSI deadlock strike	E3	Standard	
2 3/4" ANSI deadlock strike	E4	Standard	
Electric Strike frame	E9	Add	\$111
(includes cover box with knockout)			
SURFACE BOLTS			
Reinforcement only		Add	\$27
WELDED ASSEMBLIES (3 SIDED FRAMED)			
Seam Weld Die Miter (KD)	SW	Add	\$86
Full Weld Die Miter (KD)	FW	Add	\$154

M-16 KD Frames

Frame Prices

May, 2024



	WIDTH	HEIGHT	5-3/4	3 THRU 6	6-1/8 THRU 7-7/8	8 THRU 9-7/8	10 THRU 11-7/8	12 THRU 14
SINGLES	1'6" THRU 3'0"	6'8"	\$239	\$254	\$290	\$337	\$392	\$448
		7'	\$245	\$257	\$294	\$341	\$395	\$452
		7'2"	\$263	\$277	\$313	\$359	\$413	\$468
		8'	\$301	\$315	\$351	\$398	\$454	\$508
		9'	\$324	\$338	\$370	\$420	\$473	\$529
	3' + THRU 4'0"	6'8"	\$252	\$267	\$300	\$350	\$405	\$458
		7'	\$258	\$270	\$304	\$354	\$408	\$462
		7'2"	\$276	\$290	\$323	\$372	\$426	\$478
		8'	\$314	\$328	\$361	\$411	\$467	\$518
		9'	\$337	\$351	\$380	\$433	\$486	\$539
DOUBLES	4' + THRU 6'0"	6'8"	\$307	\$321	\$358	\$417	\$499	\$563
		7'	\$315	\$325	\$362	\$423	\$503	\$567
		7'2"	\$329	\$343	\$374	\$439	\$519	\$579
		8'	\$381	\$393	\$428	\$489	\$573	\$633
		9'	\$411	\$425	\$454	\$519	\$599	\$661
	6' + THRU 8'0"	6'8"	\$329	\$343	\$380	\$439	\$523	\$586
		7'	\$337	\$347	\$384	\$445	\$527	\$590
		7'2"	\$351	\$365	\$396	\$461	\$543	\$602
		8'	\$403	\$415	\$450	\$511	\$597	\$656
		9'	\$433	\$447	\$476	\$541	\$623	\$684
8' + THRU 10'0"	6'8"	\$359	\$373	\$410	\$469	\$553	\$615	
	7'	\$367	\$377	\$414	\$475	\$557	\$619	
	7'2"	\$381	\$395	\$426	\$491	\$573	\$631	
	8'	\$433	\$445	\$480	\$541	\$627	\$685	
	9'	\$463	\$477	\$506	\$571	\$653	\$713	
	10'	\$493	\$507	\$542	\$603	\$687	\$743	
FRAME COMPONENT PART PRICES (NO ANCHORS)								
STRIKE JAMBS	6'8"	\$81	\$88	\$100	\$121	\$143	\$164	
	7'	\$83	\$89	\$102	\$122	\$144	\$166	
	7'2"	\$94	\$100	\$115	\$132	\$154	\$176	
	8'	\$103	\$110	\$123	\$143	\$165	\$186	
	9'	\$111	\$117	\$129	\$150	\$171	\$193	
	10'	\$118	\$123	\$137	\$156	\$179	\$200	
HINGE JAMBS	6'8"	\$95	\$101	\$116	\$134	\$156	\$179	
	7'	\$99	\$103	\$118	\$137	\$158	\$181	
	7'2"	\$106	\$112	\$124	\$145	\$166	\$187	
	8'	\$129	\$134	\$148	\$167	\$190	\$211	
	9'	\$144	\$150	\$161	\$182	\$203	\$225	
HEADS	1'6" THRU 3'0"	\$45	\$47	\$56	\$64	\$75	\$87	
	3'+ THRU 4'0"	\$58	\$60	\$66	\$77	\$88	\$97	
	4'+ THRU 6'0"	\$99	\$101	\$108	\$131	\$169	\$187	
	6'+ THRU 8'0"	\$121	\$123	\$130	\$153	\$193	\$210	
	8'+ THRU 10'0"	\$151	\$153	\$160	\$183	\$223	\$239	

GENERAL INFORMATION

CURRIES M series frames are available double rabbet (equal or unequal) single rabbet, cased opening, nailer frame, or double egress profile. Prices reflect hardware preparations for 1 3/4" doors. Refer to CURRIES Architectural Technical Data Manual for standard details and limitations.

EXPANDED KD CAPABILITIES

- 2" Face unequal rabbet profiles are standard.
- Identical profile jambs and heads 1" face through 2" face in 1/8" increments are now available KD, M, G, NM, and MK profile.
- Identical profile jambs and heads are available 2-1/8" face through 4" face in 1/8" increments KD, in M, G, N, and MK profile. Add 25% to the 2" face frame base price (i.e.: faces may be unequal, 1-1/2" face door side and 3-1/4" face opposite, but identical profile, jambs to head).
- Returns can vary 7/16" minimum through 1" maximum. Add 15%.
- Rabbits can vary 5/8" minimum and 6" maximum for the non door rabbet. Contact factory for bend limitations on any KD profiles with rabbits exceeding 6". A 15% add is applicable to frame price for returns and or rabbits. Jamb depth ranges are listed above each column. 1/8" increment jamb depths (all ranges 3" thru 14") are available at no extra charge.

ANCHORS - foot clips are welded in place.

Standard loose jamb anchors are included in these prices; 3 per jamb up to 7'6" and 4 per jamb over 7'6". Complete anchor information is listed in the Engineered Frame Section.

Welding charge only per anchor Add \$3
(Add for appropriate anchor)

EXTRAS

BUNDLING AND TAGGING FRAMES

Frame Order Code 3F, 3FH, 3FV, 2F, SL, BL, 4F
BL, and 4F component bundling or
or welded frames Add \$6
Visual ID tags Add \$6

CASED OPENING FRAMES (4 1/2" - 14")

Per frame Add \$18
Per Piece Add \$6
Cased opening price includes standard mortise hardware preparations, hinges and strikes or blank.

COMMUNICATING FRAME (4 7/8" - 14")

Available for 1 3/4" doors N/C

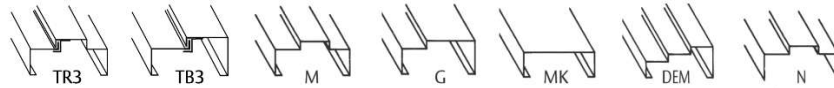

EXTRAS

CURRISEAL FRAME (4 1/8" - 14")

Gasketed frame price includes gasket.
Available for 1 3/4" door
Maximum size 4080 / 8080

	Add	\$174
Head	Add	\$58
Jamb	Add	\$58

Additional gasket prices and stock numbers are listed in the Engineered Frame Section.

DOUBLE EGRESS (4 3/4" - 14")

Available for 1 3/4" doors

Per frame	Add	\$583
Per hinge jamb	Add	\$146
Per splice welded head	Add	\$291

Anchors in head required for fire rating

DUTCH DOOR FRAME N/C

FOUR (4") INCH FACE HEADS (4-3/4" - 14") JAMB DEPTH

Available for 1 3/4" doors

Single including 4'0"	Add	\$57
Pairs over 4'0"	Add	\$80

GALVANNEAL (A40 & A60) FRAME ADDS

		<u>A40</u>	<u>A60</u>
Price per frame piece	Add	\$10	\$18
Price per 3-Sided frame	Add	\$30	\$54
Double egress	Add		\$71

GALVANIZED (G-90)

Price per frame piece	Add	\$31
Price per 3 sided frame	Add	\$93
Double egress	Add	\$124

FIRE FRAME LABELS

Warnock Hersey - Specify on order

Embossment; no hourly or 1-1/2 hour rating	Standard	
Metal label with hourly rating on hinge jamb	Add	\$29

Underwriters Laboratories

Prices are less closer (CL)

		LESS
		<u>CL</u>
Single Frame	Add	\$29
Double frame	Add	\$58

EXTRAS

MERCURY 3 THERMAL BREAK FRAMES - (5 3/4"-14")

Price galvanneal A60 frame	TR3, TB3	Add	\$804
Per jamb A60		Add	\$268
Per head A60		Add	\$268
Per jamb G90		Add	\$299
Per head G90		Add	\$299

HARDWARE PREPARATIONS

CLOSER PREPARATIONS

Concealed closer		Add	\$267
Regular arm	E10	Add	\$30
Parallel arm	E11	Add	\$30
Half sleeve	E18	Add	\$38
Full sleeve	E17	Add	\$46

FLUSH BOLTS

Standard ANSI 115.4	H2	Add	\$53
Reversible (strike plate included)	H5	Add	\$53
Reinforce Only	H1	Add	\$30

HINGE PREPARATIONS

4 1/2" standard or heavyweigjt	Standard	
1 1/2 pair up to and including 7'6"	Standard	
2 pair over 7'6" to 10'0"	Standard	
5" standard or heavyweight	Add	\$9
Full surface mounted continuous hinge reinforcement	Add	\$80
High frequency reinforcement strap support		
Per hinge	Add	\$24

HOLDERS

Overhead concealed	Add	\$158
Overhead stop & holder surface mounted 14 ga	Add	\$30

PIVOTS

Top & bottom set single acting	Per frame	Add	\$248
	Per jamb	Add	\$103
	Per jead	Add	\$145
Intermediate pivot single acting	Eacj	Add	\$87

PANIC EXIT REINFORCING

Rim Type	E8	Add	\$30
Rim vertical rod surface mounted strike	E5	Add	\$30
Vertical rod mortise strike in head - Each	G20	Add	\$65

STRIKES

4 7/8" ANSI lipped strike	E1	Standard	
2 3/4" ANSI lipped strike	E2	Standard	
3 1/2" ANSI deadlock srike	E3	Standard	
2 3/4" ANSI deadlock strike	E4	Standard	
Electric Strike frame	E9	Add	\$111
(Includes cover box with knockout)			

SURFACE BOLTS

Reinforcement only	Add	\$27
--------------------	-----	------

WELDED ASSEMBLIES (3 SIDED FRAMED)

Seam Weld Die Miter (KD)	SW	Add	\$86
Full Weld Die Miter (KD)	FW	Add	\$154

M-14 KD Frames

Frame Prices

May, 2024



	WIDTH	HEIGHT	5-3/4	3 THRU 6	6-1/8 THRU 7-7/8	8 THRU 9-7/8	10 THRU 11-7/8	12 THRU 14
SINGLES	1'6" THRU 3'0"	6'8"	\$300	\$315	\$349	\$397	\$452	\$505
		7'	\$313	\$326	\$360	\$409	\$465	\$518
		7'2"	\$327	\$342	\$377	\$422	\$480	\$532
		8'	\$373	\$389	\$422	\$473	\$528	\$580
		9'	\$398	\$410	\$443	\$491	\$548	\$601
	10'	\$419	\$432	\$466	\$516	\$572	\$623	
	3' + THRU 4'0"	6'8"	\$312	\$329	\$363	\$411	\$465	\$520
		7'	\$325	\$340	\$374	\$423	\$478	\$533
		7'2"	\$339	\$356	\$391	\$436	\$493	\$547
		8'	\$385	\$403	\$436	\$487	\$541	\$595
9'		\$410	\$424	\$457	\$505	\$561	\$616	
10'	\$431	\$446	\$480	\$530	\$585	\$638		
DOUBLES	4' + THRU 6'0"	6'8"	\$383	\$396	\$433	\$494	\$576	\$637
		7'	\$393	\$408	\$445	\$506	\$586	\$651
		7'2"	\$407	\$422	\$457	\$516	\$602	\$663
		8'	\$473	\$488	\$523	\$586	\$668	\$731
		9'	\$501	\$514	\$549	\$608	\$692	\$755
	10'	\$533	\$546	\$581	\$644	\$726	\$787	
	6' + THRU 8'0"	6'8"	\$406	\$418	\$454	\$516	\$598	\$658
		7'	\$416	\$430	\$466	\$528	\$608	\$672
		7'2"	\$430	\$444	\$478	\$538	\$624	\$684
		8'	\$496	\$510	\$544	\$608	\$690	\$752
9'		\$524	\$536	\$570	\$630	\$714	\$776	
10'	\$556	\$568	\$602	\$666	\$748	\$808		
8' + THRU 10'0"	6'8"	\$446	\$460	\$496	\$558	\$639	\$700	
	7'	\$456	\$472	\$508	\$570	\$649	\$714	
	7'2"	\$470	\$486	\$520	\$580	\$665	\$726	
	8'	\$536	\$552	\$586	\$650	\$731	\$794	
	9'	\$564	\$578	\$612	\$672	\$755	\$818	
10'	\$596	\$610	\$644	\$708	\$789	\$850		
FRAME COMPONENT PART PRICES (NO ANCHORS)								
STRIKE JAMBS	6'8"	\$107	\$114	\$127	\$146	\$167	\$190	
	7'	\$115	\$119	\$132	\$152	\$175	\$196	
	7'2"	\$122	\$128	\$143	\$160	\$182	\$204	
	8'	\$132	\$139	\$152	\$173	\$194	\$215	
	9'	\$143	\$147	\$160	\$180	\$202	\$224	
	10'	\$148	\$153	\$167	\$187	\$209	\$230	
HINGE JAMBS	6'8"	\$119	\$124	\$139	\$158	\$180	\$201	
	7'	\$124	\$130	\$145	\$164	\$185	\$208	
	7'2"	\$131	\$137	\$151	\$169	\$193	\$214	
	8'	\$161	\$167	\$181	\$201	\$223	\$245	
	9'	\$175	\$180	\$194	\$212	\$235	\$257	
	10'	\$191	\$196	\$210	\$230	\$252	\$273	
HEADS	1'6" THRU 3'0"	\$56	\$59	\$65	\$75	\$87	\$96	
	3'+ THRU 4'0"	\$68	\$73	\$79	\$89	\$100	\$111	
	4'+ THRU 6'0"	\$127	\$130	\$137	\$160	\$198	\$217	
	6'+ THRU 8'0"	\$150	\$152	\$158	\$182	\$220	\$238	
	8'+ THRU 10'0"	\$190	\$194	\$200	\$224	\$261	\$280	

GENERAL INFORMATION

CURRIES M series frames are available double rabbet (equal or unequal) single rabbet, cased opening, nailer frame, or double egress profile. Prices reflect hardware preparations for 1 3/4" doors. Refer to CURRIES Architectural Technical Data Manual for standard details and limitations.

EXPANDED KD CAPABILITIES

- 2" Face unequal rabbet profiles are standard.
- Identical profile jambs and heads 1" face through 2" face in 1/8" increments are now available KD, M, G, NM, and MK profile.
- Identical profile jambs and heads are available 2-1/8" face through 4" face in 1/8" increments KD, in M, G, N, and MK profile. Add 25% to the 2" face frame base price (i.e.: faces may be unequal, 1-1/2" face door side and 3-1/4" face opposite, but identical profile, jambs to head).
- Returns can vary 7/16" minimum through 1" maximum. Add 15%.
- Rabbets can vary 5/8" minimum and 6" maximum for the non door rabbet. Contact factory for bend limitations on any KD profiles with rabbets exceeding 6". A 15% add is applicable to frame price for returns and or rabbets. Jamb depth ranges are listed above each column. 1/8" increment jamb depths (all ranges 3" thru 14") are available at no extra charge.

ANCHORS - foot clips are welded in place.

Standard loose jamb anchors are included in these prices; 3 per jamb up to 7'6" and 4 per jamb over 7'6". Complete anchor information is listed in the Engineered Frame Section.

Welding charge only per anchor Add \$3
(Add for appropriate anchor)

EXTRAS

BUNDLING AND TAGGING FRAMES

Frame Order Code 3F, 3FH, 3FV, 2F, SL, BL, BL, and 4F component bundling or or welded frames Add \$6
Visual ID tags Add \$6

CASED OPENING FRAMES (4 1/2" - 14")

Per frame Add \$18
Per piece Add \$6

Cased opening price includes standard mortise hardware preparations, hinges and strikes or blank.

COMMUNICATING FRAME (4 7/8" - 14")

Available for 1 3/4" doors N/C



EXTRAS

CURRISEAL FRAME (4 1/8" - 14")

Gasketed frame price includes gasket.
 Available for 1 3/4" door
 Maximum size 4080 / 8080

Head	Add	\$58
Jamb	Add	\$58

Additional gasket prices and stock numbers are listed in the Engineered Frame Section.

DOUBLE EGRESS (4 3/4" - 14")

Available for 1 3/4" doors

Per frame	Add	\$583
Per hinge jamb	Add	\$146
Per splice welded head	Add	\$291

Anchors in head required for fire rating

DUTCH DOOR FRAME N/C

FOUR (4") INCH FACE HEADS (4-3/4" - 14") JAMB DEPTH

Available for 1 3/4" doors

Single including 4'0"	Add	\$57
Pairs over 4'0"	Add	\$80

GALVANNEAL (A40 & A60) FRAME ADDS

		<u>A40</u>	<u>A60</u>
Price per frame piece	Add	\$10	\$18
Price per 3-Sided frame	Add	\$30	\$54
Double egress	Add		\$71

GALVANIZED (G-90)

Price per frame piece	Add	\$31
Price per 3 sided frame	Add	\$93
Double egress	Add	\$124

FIRE FRAME LABELS

Warnock Hersey - Specify on order

Embossment; no hourly or 1-1/2 hour rating	Standard	
Metal label with hourly rating on hinge jamb	Add	\$29

Underwriters Laboratories

Prices are less closer (CL)

	LESS	
	<u>CL</u>	
Single Frame	Add	\$29
Double frame	Add	\$58

EXTRAS

MERCURY 3 THERMAL BREAK FRAMES - (5 3/4"-14")

Price galvanneal A60 frame	TR3, TB3	Add	\$804
Per jamb A60		Add	\$268
Per head A60		Add	\$268
Per jamb G90		Add	\$299
Per head G90		Add	\$299

HARDWARE PREPARATIONS

CLOSER PREPARATIONS

Concealed closer		Add	\$267
Regular arm	E10	Add	\$30
Parallel arm	E11	Add	\$30
Half sleeve	E18	Add	\$38
Full sleeve	E17	Add	\$46

FLUSH BOLTS

Standard ANSI 115.4	H2	Add	\$53
Reversible (strike plate included)	H5	Add	\$53
Reinforce Only	H1	Add	\$30

HINGE PREPARATIONS

4 1/2" standard or heavyweight		Standard	
1 1/2 pair up to and including 7'6"		Standard	
2 pair over 7'6" to 10'0"		Standard	
5" standard or heavyweight		Add Each	\$9
Full surface mounted continuous hinge reinforcement		Add	\$80
High frequency reinforcement strap support			
Per hinge		Add	\$24

HOLDERS

Overhead concealed		Add	\$158
Overhead stop & holder surface mounted 14 ga		Add	\$30

PIVOTS

Top & bottom set single acting	Per frame	Add	\$248
	Per jamb	Add	\$103
	Per head	Add	\$145
Intermediate pivot single acting	Each	Add	\$87

PANIC EXIT REINFORCING

Rim Type	E8	Add	\$30
Rim vertical rod surface mounted strike	E5	Add	\$30
Vertical rod mortise strike in head - Each	G20	Add	\$65

STRIKES

4 7/8" ANSI lipped strike	E1	Standard	
2 3/4" ANSI lipped strike	E2	Standard	
3 1/2" ANSI deadlock strike	E3	Standard	
2 3/4" ANSI deadlock strike	E4	Standard	
Electric Strike frame	E9	Add	\$111

(Includes cover box with knockout)

SURFACE BOLTS

Reinforcement only		Add	\$27
--------------------	--	-----	------

WELDED ASSEMBLIES (3 SIDED FRAMED)

Seam Weld Die Miter (KD)	SW	Add	\$86
Full Weld Die Miter (KD)	FW	Add	\$154

	WIDTH	HEIGHT	5-3/4	3 THRU 6	6-1/8 THRU 7-7/8	8 THRU 9-7/8	10 THRU 11-7/8	12 THRU 14
SINGLES	1'6" THRU 3'0"	6'8"	\$621	\$636	\$674	\$723	\$777	\$831
		7'	\$627	\$644	\$681	\$728	\$782	\$839
		7'2"	\$654	\$672	\$709	\$757	\$809	\$865
		8'	\$717	\$732	\$768	\$816	\$871	\$926
		9'	\$746	\$761	\$804	\$850	\$907	\$961
	3' + THRU 4'0"	10'	\$777	\$795	\$833	\$883	\$938	\$994
		6'8"	\$642	\$655	\$693	\$742	\$796	\$850
		7'	\$648	\$663	\$700	\$747	\$801	\$858
		7'2"	\$675	\$691	\$728	\$776	\$828	\$884
		8'	\$738	\$751	\$787	\$835	\$890	\$945
DOUBLES	4' + THRU 6'0"	9'	\$767	\$780	\$823	\$869	\$926	\$980
		10'	\$798	\$814	\$852	\$902	\$957	\$1,013
		6'8"	\$727	\$741	\$781	\$843	\$924	\$986
		7'	\$735	\$749	\$789	\$849	\$930	\$996
		7'2"	\$753	\$771	\$807	\$873	\$950	\$1,012
	6' + THRU 8'0"	8'	\$839	\$853	\$891	\$953	\$1,034	\$1,098
		9'	\$875	\$891	\$933	\$995	\$1,078	\$1,142
		10'	\$919	\$937	\$975	\$1,041	\$1,122	\$1,186
		6'8"	\$761	\$774	\$813	\$876	\$958	\$1,019
		7'	\$769	\$782	\$821	\$882	\$964	\$1,029
	8' + THRU 10'0"	7'2'	\$787	\$804	\$839	\$906	\$984	\$1,045
		8'	\$873	\$886	\$923	\$986	\$1,068	\$1,131
9'		\$909	\$924	\$965	\$1,028	\$1,112	\$1,175	
10'		\$953	\$970	\$1,007	\$1,074	\$1,156	\$1,219	
6'8"		\$807	\$821	\$862	\$929	\$1,011	\$1,072	
7'		\$815	\$829	\$870	\$935	\$1,017	\$1,082	
7'2'		\$833	\$851	\$888	\$959	\$1,037	\$1,098	
FRAME COMPONENT PART PRICES (NO ANCHORS)	STRIKE JAMBS	8'	\$919	\$933	\$972	\$1,039	\$1,121	\$1,184
		9'	\$955	\$971	\$1,014	\$1,081	\$1,165	\$1,228
		10'	\$999	\$1,017	\$1,056	\$1,127	\$1,209	\$1,272
		6'8"	\$210	\$215	\$230	\$251	\$272	\$294
		7'	\$212	\$219	\$233	\$253	\$274	\$297
HINGE JAMBS	7'2"	\$230	\$236	\$252	\$270	\$291	\$315	
	8'	\$247	\$252	\$266	\$286	\$308	\$330	
	9'	\$258	\$262	\$281	\$299	\$322	\$343	
	10'	\$267	\$273	\$289	\$309	\$331	\$354	
	6'8"	\$224	\$229	\$245	\$264	\$286	\$307	
HEADS	1'6" THRU 3'0"	7'	\$228	\$233	\$249	\$267	\$289	\$312
		7'2"	\$237	\$244	\$258	\$279	\$299	\$320
		8'	\$277	\$282	\$297	\$316	\$338	\$360
		9'	\$295	\$301	\$318	\$337	\$360	\$382
		10'	\$317	\$324	\$339	\$360	\$382	\$404
	3'+ THRU 4'0"	1'6" THRU 3'0"	\$169	\$174	\$181	\$190	\$201	\$212
		3'+ THRU 4'0"	\$190	\$193	\$200	\$209	\$220	\$231
		4'+ THRU 6'0"	\$261	\$265	\$273	\$297	\$334	\$354
		6'+ THRU 8'0"	\$295	\$298	\$305	\$330	\$368	\$387
		8'+ THRU 10'0"	\$341	\$345	\$354	\$383	\$421	\$440

GENERAL INFORMATION

CURRIES M series frames are available double rabbet (equal or unequal) single rabbet, cased opening, nailer frame, or double egress profile. Prices reflect hardware preparations for 1 3/4" doors. Refer to CURRIES Architectural Technical Data Manual for standard details and limitations.

All equal face profile corners are sw miter only. 4" face heads and 2" face jambs are SMO. Double egress and all other concern will be saw butt end.

Miter and notch charges are included with these list prices on this page.

Note: 5-3/4" jamb depth frames have 1/2" minimum back bend. 7/16" N.A.

2" face unequal rabbet profile frames are standard. Double rabbet 1", 1 1/4", 1 1/2" and 1 3/4" face frames re priced the same as 2" face at no extra charge.

Jamb depth ranges are listed above each column. 1/8" increment jamb depths (all ranges 3" thru 14") are available at no extra charge.

ANCHORS - foot clips are welded in place.

Standard loose jamb anchors are included in these prices; 3 per jamb up to 7'6" and 4 per jamb over 7'6".

Complete anchor information is listed in the Engineered Frame Section.

Welding charge only per anchor Add \$3
(Add for appropriate anchor)

EXTRAS

BUNDLING AND TAGGING FRAMES

Frame Order Code 3F, 3FH, BL, and 4F component bundling or or welded frames Add \$6
Visual ID Add \$6

CASED OPENING FRAMES (4 1/2" - 14")

Per frame Add \$18
Per piece Add \$6
Cased opening price includes standard mortise hardware preparations, hinges and strikes or blank.

COMMUNICATING FRAME (4 7/8" - 14")

Available for 1 3/4" doors N/C

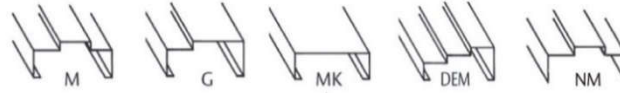

DOUBLE EGRESS (4 3/4" - 14")

Available for 1-3/4" doors. See page 17 of Engineered Frames

DUTCH DOOR FRAME N/C

FOUR (4") INCH FACE HEADS (4 3/4" - 14") JAMB DEPTH

Available for 1 3/4" doors

Single including 4'0" Add \$57

Pairs over 4'0" Add \$80

GALVANNEAL (A40 & A60) FRAME ADDS A40 A60

Price per frame piece Add \$10 \$18

Price per 3 Sided frame Add \$30 \$54

GALVANIZED (G-90)

Price per frame piece Add \$31

Price per 3 Sided frame Add \$93

FIRE FRAME LABELS

Warnock Hersey - Specify on order

Embossment; no hourly or 1-1/2 hour rating Standard

Metal label with hourly rating on hinge jamb Add \$29

Underwriters Laboratories

Prices are less closer (CL)

LESS

CL

Single frame Add \$29

Double frame Add \$58

HARDWARE PREPARATIONS

CLOSER PREPARATIONS

Concealed closer Add \$267

Regular arm E10 Add \$30

Parallel arm E11 Add \$30

Half sleeve E18 Add \$38

Full sleeve E17 Add \$46

FLUSH BOLTS

Standard ANSI 115.4 H2 Add \$53

Reversible (strike plate included) H5 Add \$53

Reinforce only H1 Add \$30

HINGE PREPARATIONS

4 1/2" standard or heavyweight Add \$18

1 1/2 pair up to and including 7'6" Add \$18

2 pair over 7'6" to 10'0" Add \$18

5" standard or heavyweight Add Each \$9

Full surface mounted continuous hinge reinforcement Add \$80

High frequency reinforcement strap support

Per hinge Add 15 \$24

HOLDERS

Overhead concealed Add \$158

Overhead stop and holder surface mounted 14 ga Add \$30

PIVOTS

Top and bottom set single acting Per frame Add \$248

Per jamb Add \$103

Per head Add \$145

Each Add \$87

Intermediate pivot single acting

PANIC EXIT REINFORCING

Rim type E8 Add \$30

Rim vertical rod surface mounted strike E5 Add \$30

Vertical rod mortise strike in head-Each G20 Add \$65

STRIKES

4 7/8" ANSI lipped strike E1 Add \$18

2 3/4" ANSI lipped strike E2 Add \$18

3 1/2" ANSI deadlock strike E3 Add \$18

2 3/4" ANSI deadlock strike E4 Add \$18

Electric strike frame E9 Add \$111

(includes cover box with knockout)

SURFACE BOLTS

Reinforcement only Add \$27

M-16 KD Borrowed Lites

Frame Prices

May, 2024



BORROWED LITE K.D. (KNOCKED DOWN) M SERIES

FOR NEW CONSTRUCTION - NOTE: Installation is recommended as the wall is being built.

Masonry M-profile 16 gauge, loose or welded in anchors, 1", 1 1/4", 1 1/2", 1 3/4", 2" face.

G-profile 16 gauge 2" face only. Add \$28.00 for U.L. Label. M profile 2" face vertical members are available with 4" face horizontal members.

Use 4" face head add.

NOTE: 4" face members should only be used when frame corners are welded.

NOTE: Standard 5/8" x 5/8" glass stop is cut to length, punched, dimpled and shipped loose. Glass stop is punched 2" in from each end and 12" on center.

Price glass stop at \$6.00 list per foot. Self drilling #8 TEK screws for glass stop are included. Corner screws are furnished upon request at no charge.

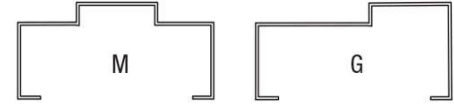

WIDTH X HEIGHT	3 THRU 6	6-1/8 THRU 7-7/8	8 THRU 9-7/8	10 THRU 11-7/8	12 THRU 14
	CR	CR	CR	CR	CR
1'6" min - 3'0" x 3'0"	\$204	\$233	\$267	\$307	\$350
1'6" min - 3'0" x 4'0"	\$230	\$263	\$301	\$349	\$398
1'6" min - 3'0" x 5'0"	\$255	\$292	\$336	\$390	\$445
1'6" min - 3'0" x 6'0"	\$281	\$321	\$371	\$431	\$493
3'1" - 4'0" x 3'0"	\$230	\$253	\$293	\$333	\$370
3'1" - 4'0" x 4'0"	\$256	\$283	\$327	\$375	\$418
3'1" - 4'0" x 5'0"	\$281	\$312	\$362	\$416	\$465
3'1" - 4'0" x 6'0"	\$307	\$341	\$397	\$457	\$513
4'1" - 6'0" x 3'0"	\$312	\$337	\$401	\$495	\$550
4'1" - 6'0" x 4'0"	\$338	\$367	\$435	\$537	\$598
4'1" - 6'0" x 5'0"	\$363	\$396	\$470	\$578	\$645
4'1" - 6'0" x 6'0"	\$389	\$425	\$505	\$619	\$693

GALVANNEAL (A40 & A60) A40 A60
 Add \$40.00 \$72.00

BORROWED LITE K.D. (KNOCKED DOWN) MK SERIES

FOR NEW CONSTRUCTION - NOTE: Installation is recommended as the wall is being built.

Masonry MK-profile 16 gauge, loose or welded in anchors, 2" face.

NOTE: Standard 5/8" x 5/8" glass stop is cut to length, punched, dimpled and shipped loose. Glass stop is punched 2" in from each end and 12" on center.

Price glass stop at \$6.00 list per foot. Self drilling #8 TEK screws for glass stop are included. Corner screws are furnished upon request at no charge.



WIDTH X HEIGHT	3 THRU 6	6-1/8 THRU 7-7/8	8 THRU 9-7/8	10 THRU 11-7/8	12 THRU 14
	CR	CR	CR	CR	CR
1'6" min - 3'0" x 3'0"	\$222	\$251	\$285	\$325	\$368
1'6" min - 3'0" x 4'0"	\$248	\$281	\$319	\$367	\$416
1'6" min - 3'0" x 5'0"	\$273	\$310	\$354	\$408	\$463
1'6" min - 3'0" x 6'0"	\$299	\$339	\$389	\$449	\$511
3'1" - 4'0" x 3'0"	\$248	\$271	\$311	\$351	\$388
3'1" - 4'0" x 4'0"	\$274	\$301	\$345	\$393	\$436
3'1" - 4'0" x 5'0"	\$299	\$330	\$380	\$434	\$483
3'1" - 4'0" x 6'0"	\$325	\$359	\$415	\$475	\$531
4'1" - 6'0" x 3'0"	\$330	\$355	\$419	\$513	\$568
4'1" - 6'0" x 4'0"	\$356	\$385	\$453	\$555	\$616
4'1" - 6'0" x 5'0"	\$381	\$414	\$488	\$596	\$663
4'1" - 6'0" x 6'0"	\$407	\$443	\$523	\$637	\$711

GALVANNEAL (A40 & A60) A40 A60
 Add \$40.00 \$72.00

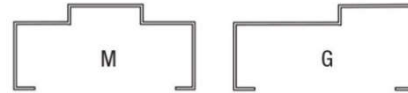
BORROWED LITE K.D. (KNOCKED DOWN) M SERIES
FOR NEW CONSTRUCTION - NOTE: Installation is recommended as the wall is be

Masonry M-profile 16 gauge, loose or welded in anchors, 1", 1 1/4", 1 1/2", 1 3/4", 2" face.

G-profile 16 gauge 2" face only. Add \$28.00 for U.L. Label. M profile 2" face vertical members are available with 4" face horizontal members.

Use 4" face head add.

NOTE: 4" face members should only be used when frame corners are welded.

NOTE: Standard 5/8" x 5/8" glass stop is cut to length, punched, dimpled and shipped loose. Glass stop is punched 2" in from each end and 12" on center.

Price glass stop at \$6.00 list per foot. Self drilling #8 TEK screws for glass stop are included. Corner screws are furnished upon request at no charge.

WIDTH X HEIGHT	3 THRU 6	6-1/8 THRU 7-7/8	8 THRU 9-7/8	10 THRU 11-7/8	12 THRU 14
	CR	CR	CR	CR	CR
1'6" min - 3'0" x 3'0"	\$254	\$277	\$314	\$358	\$394
1'6" min - 3'0" x 4'0"	\$288	\$315	\$358	\$408	\$450
1'6" min - 3'0" x 5'0"	\$322	\$353	\$401	\$458	\$506
1'6" min - 3'0" x 6'0"	\$356	\$390	\$445	\$508	\$562
3'1" - 4'0" x 3'0"	\$282	\$305	\$342	\$384	\$424
3'1" - 4'0" x 4'0"	\$316	\$343	\$386	\$434	\$480
3'1" - 4'0" x 5'0"	\$350	\$381	\$429	\$484	\$536
3'1" - 4'0" x 6'0"	\$384	\$418	\$473	\$534	\$592
4'1" - 6'0" x 3'0"	\$396	\$421	\$484	\$580	\$636
4'1" - 6'0" x 4'0"	\$430	\$459	\$528	\$630	\$692
4'1" - 6'0" x 5'0"	\$464	\$497	\$571	\$680	\$748
4'1" - 6'0" x 6'0"	\$498	\$534	\$615	\$730	\$804

GALVANNEAL (A40 & A60)

	<u>A40</u>	<u>A60</u>
Add	\$40.00	\$72.00

BORROWED LITE K.D. (KNOCKED DOWN) MK SERIES
FOR NEW CONSTRUCTION - NOTE: Installation is recommended as the wall is being built.

Masonry MK-profile 16 gauge, loose or welded in anchors, 2" face.

NOTE: Standard 5/8" x 5/8" glass stop is cut to length, punched, dimpled and shipped loose. Glass stop is punched 2" in from each end and 12" on center.

Price glass stop at \$6.00 list per foot. Self drilling #8 TEK screws for glass stop are included. Corner screws are furnished upon request at no charge.



WIDTH X HEIGHT	3 THRU 6	6-1/8 THRU 7-7/8	8 THRU 9-7/8	10 THRU 11-7/8	12 THRU 14
	CR	CR	CR	CR	CR
1'6" min - 3'0" x 3'0"	\$272	\$295	\$332	\$376	\$412
1'6" min - 3'0" x 4'0"	\$306	\$333	\$376	\$426	\$468
1'6" min - 3'0" x 5'0"	\$340	\$371	\$419	\$476	\$524
1'6" min - 3'0" x 6'0"	\$374	\$408	\$463	\$526	\$580
3'1" - 4'0" x 3'0"	\$300	\$323	\$360	\$402	\$442
3'1" - 4'0" x 4'0"	\$334	\$361	\$404	\$452	\$498
3'1" - 4'0" x 5'0"	\$368	\$399	\$447	\$502	\$554
3'1" - 4'0" x 6'0"	\$402	\$436	\$491	\$552	\$610
4'1" - 6'0" x 3'0"	\$414	\$439	\$502	\$598	\$654
4'1" - 6'0" x 4'0"	\$448	\$477	\$546	\$648	\$710
4'1" - 6'0" x 5'0"	\$482	\$515	\$589	\$698	\$766
4'1" - 6'0" x 6'0"	\$516	\$552	\$633	\$748	\$822

GALVANNEAL (A40 & A60)

	<u>A40</u>	<u>A60</u>
Add	\$40.00	\$72.00

	WIDTH	HEIGHT	3 THRU 6	6-1/8 THRU 7-7/8	8 THRU 9-7/8		
SINGLES	1'6" THRU 3'0"	6'8"	\$267	\$302	\$389		
		7'	\$271	\$305	\$393		
	3' + THRU 4'0"	7'2"	\$292	\$328	\$416		
		8'	\$335	\$371	\$459		
		6'8"	\$281	\$316	\$403		
		7'	\$285	\$319	\$407		
DOUBLES	4' + THRU 6'0"	7'2"	\$306	\$342	\$430		
		8'	\$349	\$385	\$473		
		6'8"	\$344	\$384	\$478		
		7'	\$350	\$388	\$484		
	6' + THRU 8'0"	7'2"	\$366	\$410	\$504		
		8'	\$426	\$466	\$562		
FRAME COMPONENT PART PRICES							
STRIKE JAMBS		6'8"	\$101	\$115	\$150		
		7'	\$102	\$116	\$151		
		7'2"	\$115	\$128	\$164		
		8'	\$128	\$143	\$178		
HINGE JAMBS		6'8"	\$116	\$129	\$164		
		7'	\$119	\$131	\$167		
		7'2"	\$127	\$142	\$177		
		8'	\$157	\$170	\$206		
HEADS	1'6" THRU 3'0"		\$50	\$58	\$75		
	3'+ THRU 4'0"		\$64	\$72	\$89		
	4'+ THRU 6'0"		\$112	\$126	\$150		
	6'+ THRU 8'0"		\$136	\$150	\$175		

GENERAL INFORMATION

CURRIES C series frames are available double rabbet (equal or unequal) single rabbet, cased opening. Prices reflect hardware preparations for 1 3/4" doors. Refer to CURRIES Architectural Technical Data Manual for standard details and limitations.

2" face unequal rabbet profile frames are standard. Double rabbet 1 1/2" and 1 3/4" face frames re priced the same as 2" face at no extra charge.

Jamb depth ranges are listed above each column. 1/8" increment jamb depths (all ranges 3" thru 9 7/8") are available at no extra charge.

ANCHORS

Drywall C Series frames have compression bars welded in place at the top of each jamb and a punched base anchor hole in the frame face at the bottom.

EXTRAS

BUNDLING AND TAGGING FRAMES

Frame Order Code 3F, 3FH, 3FV, 2F, SL, BL, and 4F component bundling or welded frames Add \$6
 Visual ID tags Add \$6

CASED OPENING FRAMES (4 1/2" - 9 7/8")

Per frame Add \$18
 Per piece Add \$6

Cased opening price includes standard mortise hardware preparations, hinges and strikes or blank.

COMMUNICATING FRAME (4 7/8" - 9 7/8")

Available for 1 3/4" doors N/C

ANCHOR*

Optional welded-in drywall strap anchor Add \$25

*Required for narrow face 1 1/2" and 1 3/4" face frames

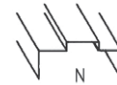

EXTRAS

NAILER frame (3 3/4" - 13") N Profile Add \$90
 NOTE: Refer To Tech Page for maximum ratings and

CURRISEAL FRAME (4 1/8" - 14")

Gasketed frame price includes gasket.
 Available for 1 3/4" door
 Maximum size 4080 / 8080 Add \$174
 Head Add \$58
 Jamb Add \$58

Additional gasket prices and stock numbers are listed in the Engineered Frame Section.

Drywall Double Egress frames not available as KD.
 Price as CCW material - welded (SMO or SBE) construction only

DUTCH DOOR FRAME N/C

FOUR (4") INCH FACE HEADS (4 3/4" - 14") JAMB DEPTH

Available for 1 3/8" or 1 3/4" doors
 Single including 4'0" Add \$57
 Pairs over 4'0" Add \$80

GALVANNEAL (A40 & A60) FRAME ADDS A40 A60

Price per frame piece \$10 \$18
 Price per 3 Sided frame \$30 \$54

GALVANIZED (G-90)

Price per frame piece Add \$31
 Price per 3 Sided frame Add \$93

EXTRAS

THERMAL BREAK FRAMES - NOT AVAILABLE

HARDWARE PREPARATIONS

CLOSER PREPARATIONS

Concealed closer Add \$267
 Regular arm E10 Add \$30
 Parallel arm E11 Add \$30
 Half sleeve E18 Add \$38
 Full sleeve E17 Add \$46

FLUSH BOLTS

Standard ANSI 115.4 H2 Add \$53
 Reversible (strike plate included) H5 Add \$53
 Reinforce only H1 Add \$30

HINGE PREPARATIONS

4 1/2" standard or heavyweight Standard
 1 1/2 Pair up to and including 7'6" Standard
 2 pair over 7'6" to 10'0" Standard
 5" standard or heavyweight Add Each \$9
 Full Surface mounted continuous hinge reinforcement Add \$80
 High frequency reinforcement strap support
 Per hinge Add \$24

HOLDERS

Overhead Concealed Add \$158
 Overhead stop and holder surface mounted 14 ga. Add \$30

PIVOTS

Top and bottom set single acting Per Frame Add \$248
 Per Jamb Add \$103
 Per head Add \$145
 Intermediate pivot single acting Each Add \$87

PANIC EXIT REINFORCING

Rim type E8 Add \$30
 Rim vertical rod surface mounted strike E5 Add \$30
 Vertical rod mortise strike in head - Each G20 Add \$65

STRIKES

4 7/8" ANSI lipped strike E1 Standard
 2 3/4" ANSI lipped strike E2 Standard
 3 1/2" ANSI deadlock strike E3 Standard
 2 3/4" ANSI deadlock strike E4 Standard
 Electric strike frame E9 Add \$111

SURFACE BOLTS

Reinforcement only Add \$27

	WIDTH	HEIGHT	3 THRU 6	6-1/8 THRU 7-7/8	8 THRU 9-7/8	10 THRU 11-7/8	12 THRU 14
SINGLES	1'6" THRU 3'0"	6'8"	\$282	\$314	\$403	\$445	\$499
		7'	\$286	\$318	\$408	\$451	\$503
		7'2"	\$307	\$341	\$430	\$472	\$527
		8'	\$349	\$385	\$473	\$516	\$571
		9'	\$375	\$407	\$498	\$539	\$592
	10'	\$402	\$435	\$521	\$565	\$620	
	3' + THRU 4'0"	6'8"	\$288	\$322	\$410	\$452	\$508
		7'	\$292	\$326	\$415	\$458	\$512
		7'2"	\$313	\$349	\$437	\$479	\$536
		8'	\$355	\$393	\$480	\$523	\$580
9'		\$381	\$415	\$505	\$546	\$601	
10'	\$408	\$443	\$528	\$572	\$629		
DOUBLES	4' + THRU 6'0"	6'8"	\$349	\$388	\$485	\$554	\$607
		7'	\$353	\$390	\$489	\$560	\$613
		7'2"	\$373	\$416	\$511	\$580	\$635
		8'	\$431	\$474	\$569	\$638	\$695
		9'	\$465	\$504	\$601	\$668	\$723
	10'	\$501	\$540	\$633	\$706	\$763	
	6' + THRU 8'0"	6'8"	\$374	\$414	\$512	\$581	\$634
		7'	\$378	\$416	\$516	\$587	\$640
		7'2"	\$398	\$442	\$538	\$607	\$662
		8'	\$456	\$500	\$596	\$665	\$722
		9'	\$490	\$530	\$628	\$695	\$750
	10'	\$526	\$566	\$660	\$733	\$790	
	8' + THRU 10'0"	6'8"	\$416	\$457	\$554	\$622	\$674
		7'	\$420	\$459	\$558	\$628	\$680
		7'2"	\$440	\$485	\$580	\$648	\$702
8'		\$498	\$543	\$638	\$706	\$762	
9'		\$532	\$573	\$670	\$736	\$790	
10'	\$568	\$609	\$702	\$774	\$830		
FRAME COMPONENT PART PRICES (NO ANCHORS)							
STRIKE JAMBS	6'8"	\$106	\$119	\$154	\$171	\$194	
	7'	\$108	\$122	\$157	\$174	\$195	
	7'2"	\$119	\$132	\$168	\$185	\$208	
	8'	\$132	\$147	\$182	\$200	\$222	
	9'	\$141	\$154	\$191	\$208	\$229	
10'	\$150	\$164	\$198	\$215	\$237		
HINGE JAMBS	6'8"	\$117	\$130	\$166	\$182	\$203	
	7'	\$119	\$131	\$168	\$185	\$206	
	7'2"	\$129	\$144	\$179	\$195	\$217	
	8'	\$158	\$173	\$208	\$224	\$247	
	9'	\$175	\$188	\$224	\$239	\$261	
10'	\$193	\$206	\$240	\$258	\$281		
HEADS	1'6" THRU 3'0"	\$59	\$65	\$83	\$92	\$102	
	3'+ THRU 4'0"	\$65	\$73	\$90	\$99	\$111	
	4'+ THRU 6'0"	\$115	\$128	\$153	\$190	\$201	
	6'+ THRU 8'0"	\$140	\$154	\$180	\$217	\$228	
	8'+ THRU 10'0"	\$182	\$197	\$222	\$258	\$268	

GENERAL INFORMATION

CURRIES C series frames are available double rabbet (equal or unequal) single rabbet, cased opening. Prices reflect hardware preparations for 1 3/4" doors. Refer to CURRIES Architectural Technical Data Manual for standard details and limitations.

Drywall frames are installed after the wall has been constructed

2" face unequal rabbet profile frames are standard. Double rabbet 1 1/2" and 1 3/4" face frames are priced the same as 2" face at no extra charge.

Jamb depth ranges are listed above each column 1/8" increment jamb depths (all ranges 3" thru 14") are available at no extra charge.

ANCHORS

DRYWALL C Series frames have compression bars welded in place at the top of each jamb and a punched base anchor in the frame face at the bottom.

EXTRAS

BUNDLING AND TAGGING FRAMES

Frame Order Code 3F, 3FH, 3FV, 2F, SL, BL, 4F

- and 4F component bundling or
- or welded frames Add \$6
- Visual ID tags Add \$6

CASED OPENING FRAMES (4 1/2" - 14")

- Per frame Add \$18
- Per piece Add \$6
- Cased opening price includes standard mortise hardware preparations, hinges and strikes or blank.

COMMUNICATING FRAME (4 7/8" - 14")

Available for 1 3/4" doors N/C

ANCHOR*

- Optional welded-in drywall strap anchor Add \$25
- *Required for narrow face 1 1/2" and 1 3/4" face frames



EXTRAS

NAILER frame (3 3/4" - 13") N Profile Add \$90

NOTE: Refer To Tech Page for maximum ratings and sizes

CURRISEAL FRAME (4 1/8" - 14")

Gasketed frame price includes gasket.

Available for 1 3/4" door

Maximum size 4080 / 8080 Add \$174

Head Add \$58

Jamb Add \$58

Additional gasket prices and stock numbers are listed in the Engineered Frame Section.

Drywall Double Egress frames not available as KD.

Price as CCW material - welded (SMO or SBE) construction only

DUTCH DOOR FRAME N/C

FOUR (4") INCH FACE HEADS (4 3/4" - 14") JAMB

Available for 1 3/8" or 1 3/4" doors

Single including 4'0" Add \$57

Pairs over 4'0" Add \$80

GALVANNEAL (A40 & A60) FRAME ADDS A40 A60

Price per frame piece \$10 \$18

Price per 3 Sided frame \$30 \$54

GALVANIZED (G-90)

Price per frame piece Add \$31

Price per 3 Sided frame Add \$93

FIRE FRAME LABELS

Warnock Hersey - Specify on order

Embossment; no hourly or 1 1/2 hour rating Standard

Metal label with hourly rating on hinge jamb Add \$29

Underwriters Laboratories

Prices are less closer (CL)

LESS

CL

Single Frame Add \$29

Double Frame Add \$58

EXTRAS

THERMAL BREAK FRAMES - NOT AVAILABLE

HARDWARE PREPARATIONS

CLOSER PREPARATIONS

Concealed closer Add \$267

Regular arm E10 Add \$30

Parallel arm E11 Add \$30

Half sleeve E18 Add \$38

Full sleeve E17 Add \$46

FLUSH BOLTS

Standard ANSI 115.4 H2 Add \$53

Reversible (strike plate included) H5 Add \$53

Reinforce only H1 Add \$30

HINGE PREPARATIONS

4 1/2" standard or heavyweight Standard

1 1/2 Pair up to and including 7'6" Standard

2 pair over 7'6" to 10'0" Standard

5" standard or heavyweight Add Each \$9

Full Surface mounted continuous hinge Add \$80

High frequency reinforcement strap support

Per hinge Add \$24

HOLDERS

Overhead Concealed Add \$158

Overhead stop and holder surface mounted 14 Add \$30

PIVOTS

Top and bottom set single acting Per Frame Add \$248

Per Jamb Add \$103

Per head Add \$145

Each Add \$87

Intermediate pivot single acting

PANIC EXIT REINFORCING

Rim type E8 Add \$30

Rim vertical rod surface mounted strike E5 Add \$30

Vertical rod mortise strike in head - Each G20 Add \$65

STRIKES

4 7/8" ANSI lipped strike E1 Standard

2 3/4" ANSI lipped strike E2 Standard

3 1/2" ANSI deadlock strike E3 Standard

2 3/4" ANSI deadlock strike E4 Standard

Electric strike frame E9 Add \$111

(includes cover box with knockout)

SURFACE BOLTS

Reinforcement only Add \$27

Swift Pac quantity frame pricing is available

C-16 KD Sidelight Frames

Frame Prices

May, 2024



WIDTH	HEIGHT		4 1/2 THRU 6	6-1/8 THRU 7-7/8	8 THRU 8 3/4"	
3' + THRU 4'0"	6'8"		\$288	\$322	\$410	
	7'		\$292	\$326	\$415	
	7'2"		\$313	\$349	\$437	
	8'		\$355	\$393	\$480	
4' + THRU 6'0"	6'8"		\$349	\$388	\$485	
	7'		\$353	\$390	\$489	
	7'2"		\$373	\$416	\$511	
	8'		\$431	\$474	\$569	
6' + THRU 8'0"	6'8"		\$374	\$414	\$512	
	7'		\$378	\$416	\$516	
	7'2"		\$398	\$442	\$538	
	8'		\$456	\$500	\$596	

VERTICAL MULLION PRICING 2" FACE (INCLUDES TOP BUTT END NOTCH, STIRRUP ANCHOR, FOOTCLIP, AND E-1 STRIKE. PRICE WILL NEED TO BE ADJUSTED FOR HINGE PREPS).

6'8"			\$299	\$331	\$373	
7'0"			\$309	\$343	\$387	
8'0"			\$341	\$380	\$430	

SILL PRICING (INCLUDES 2 BUTT END NOTCHES)

2" Face - 1' Long			\$48	\$50	\$53	
4" Face - 1' Long			\$51	\$54	\$56	
6" Face - 1' Long			\$55	\$58	\$63	
2" Face - 2' Long			\$62	\$67	\$72	
4" Face - 2' Long			\$69	\$73	\$79	
6" Face - 2' Long			\$76	\$83	\$91	
2" Face - 3' Long			\$76	\$83	\$91	
4" Face - 3' Long			\$86	\$93	\$101	
6" Face - 3' Long			\$97	\$107	\$120	
2" Face - 4' Long			\$90	\$99	\$110	
4" Face - 4' Long			\$104	\$112	\$123	
6" Face - 4' Long			\$118	\$131	\$148	

GLASS STOP - 5/8" X 5/8"

CCW 93

Included in Price

GENERAL INFORMATION

CURRIES C series frames are available double rabbet (equal or unequal) Prices reflect hardware preparations for 1 3/4" doors. Refer to CURRIES Architectural Technical Data Manual for standard details and limitations.

CURRIES Drywall KD Sidelight includes-mullion stirrup, mullion and sill notching, and reverse welded foot clip on mullion.

Drywall frames are installed after the wall has been constructed

2" face unequal rabbet profile frames are standard. Double rabbet 1 1/2" and 1 3/4" face frames re priced the same as 2" face at no extra charge.

Jamb depth ranges are listed above each column. 1/8" increment jamb depths (all ranges 4 1/2" thru 8 3/4") are available at no extra charge.

ANCHORS

Drywall C Series frames have compression bars welded in place at the top of each jamb and a punched base anchor hole in the frame face at the bottom.

EXTRAS

BUNDLING AND TAGGING FRAMES

Frame Order Code 3F, 3FH, 3FV, 2F, SL, BL, 4F

and 4F component bundling or

or welded frames

Add \$6

Visual ID tags

Add \$6

ANCHOR*

Add \$25

Optional welded-in drywall strap anchor

*Required for narrow face 1 1/2" and 1 3/4" face frames

**C-16 KD Sidelight Frames
Frame Prices**

May, 2024



EXTRAS

GALVANNEAL (A60) FRAME ADDS

Price per frame piece Add \$18

HARDWARE PREPARATIONS

CLOSER PREPARATIONS

Concealed closer		Add \$267
Regular arm	E10	Add \$30
Parallel arm	E11	Add \$30
Half sleeve	E18	Add \$38
Full sleeve	E17	Add \$46

FLUSH BOLTS

Standard ANSI 115.4	H2	Add \$53
Reversible (strike plate included)	H5	Add \$53
Reinforce only	H1	Add \$30

HINGE PREPARATIONS

4 1/2" standard or heavyweight	Standard	
1 1/2 Pair up to and including 7'6"	Standard	
2 pair over 7'6" to 10'0"	Standard	
5" standard or heavyweight	Add Each	\$9
Full Surface mounted continuous hinge reinforcement	Add	\$80
High frequency reinforcement strap support		
Per hinge	Add	\$24

HOLDERS

Overhead Concealed	Add	\$158
Overhead stop and holder surface mounted 14	Add	\$30

PIVOTS

Top and bottom set single acting	Per Frame	Add \$248
	Per Jamb	Add \$103
	Per head	Add \$145
Intermediate pivot single acting	Each	Add \$87

PANIC EXIT REINFORCING

Rim type	E8	Add \$30
Rim vertical rod surface mounted strike	E5	Add \$30
Vertical rod mortise strike in head - Each	G20	Add \$65

STRIKES

4 7/8" ANSI lipped strike	E1	Standard
2 3/4" ANSI lipped strike	E2	Standard
3 1/2" ANSI deadlock strike	E3	Standard
2 3/4" ANSI deadlock strike	E4	Standard
Electric strike frame	E9	Add \$111
(includes cover box with knockout)		

SURFACE BOLTS

Reinforcement only	Add	\$27
--------------------	-----	------

C-14 KD Frames

Frame Prices

May, 2024



	WIDTH	HEIGHT	3 THRU 6	6-1/8 THRU 7/8	8 THRU 9-7/8	10 THRU 11-7/8	12 THRU 14
SINGLES	1'6" THRU 3'0"	6'8"	\$339	\$376	\$466	\$505	\$561
		7'	\$349	\$387	\$474	\$514	\$571
		7'2"	\$366	\$402	\$493	\$533	\$589
		8'	\$413	\$451	\$540	\$580	\$637
		9'	\$440	\$478	\$568	\$608	\$664
	3' + THRU 4'0"	10'	\$472	\$508	\$596	\$636	\$693
		6'8"	\$351	\$386	\$478	\$518	\$571
		7'	\$361	\$397	\$486	\$527	\$581
		7'2"	\$378	\$412	\$505	\$546	\$599
		8'	\$425	\$461	\$552	\$593	\$647
DOUBLES	4' + THRU 6'0"	9'	\$452	\$488	\$580	\$621	\$674
		10'	\$484	\$518	\$608	\$649	\$703
		6'8"	\$422	\$462	\$560	\$628	\$682
		7'	\$438	\$480	\$574	\$644	\$698
		7'2"	\$450	\$492	\$590	\$658	\$714
	6' + THRU 8'0"	8'	\$510	\$552	\$648	\$718	\$774
		9'	\$544	\$588	\$684	\$754	\$808
		10'	\$582	\$622	\$718	\$786	\$844
		6'8"	\$445	\$486	\$584	\$651	\$706
		7'	\$461	\$504	\$598	\$667	\$722
	8' + THRU 10'0"	7'2'	\$473	\$516	\$614	\$681	\$738
		8'	\$533	\$576	\$672	\$741	\$798
		9'	\$567	\$612	\$708	\$777	\$832
		10'	\$605	\$646	\$742	\$809	\$868
		6'8"	\$494	\$534	\$632	\$700	\$753
FRAME COMPONENT PART PRICES							
STRIKE JAMBS	7'	\$130	\$145	\$180	\$196	\$219	
	7'2"	\$141	\$154	\$191	\$208	\$229	
	8'	\$158	\$173	\$209	\$225	\$247	
	9'	\$168	\$182	\$219	\$235	\$257	
	10'	\$181	\$195	\$230	\$247	\$268	
HINGE JAMBS	6'8"	\$143	\$156	\$193	\$209	\$230	
	7'	\$151	\$165	\$200	\$217	\$238	
	7'2"	\$157	\$171	\$208	\$224	\$246	
	8'	\$187	\$201	\$237	\$254	\$276	
	9'	\$204	\$219	\$255	\$272	\$293	
HEADS	10'	\$223	\$236	\$272	\$288	\$311	
	1'6" THRU 3'0"	\$68	\$77	\$94	\$101	\$114	
	3'+ THRU 4'0"	\$80	\$87	\$106	\$114	\$124	
	4'+ THRU 6'0"	\$136	\$150	\$174	\$210	\$222	
	6'+ THRU 8'0"	\$159	\$174	\$198	\$233	\$246	
8'+ THRU 10'0"	\$208	\$222	\$246	\$282	\$293		

GENERAL INFORMATION

CURRIES C series frames are available double rabbet (equal or unequal) single rabbet (2" face x 2 5/8" face), or cased opening. Prices reflect hardware preparations for 1 3/4" doors. Refer to CURRIES Architectural Technical Data Manual for standard details and limitations.

Drywall frames are installed after the wall has ben constructed.

2" face unequal rabbet profile frames are standard. 14 ga narrow face is not available K.D.

Jamb depth ranges are listed above each column 1/8" increment jamb depths (all ranges 3" thru 14") are available at no extra charge.

ANCHORS

DRYWALL C Series frames have compression bars welded in place at the top of each jamb and a punched base anchor in the frame face at the bottom.

EXTRAS

BUNDLING AND TAGGING FRAMES

Frame Order Code 3F, 3FH, 3FV, 2F, SL, BL, and 4F component bundling or welded frames
Visual ID

Add \$6
Add \$6

CASED OPENING FRAMES (4 1/2" - 14")

Per frame Add \$18
Per piece Add \$6
Cased opening price includes standard mortise hardware preparations, hinges and strikes or blank.

COMMUNICATING FRAME (4 7/8" - 14")

Available for 1 3/4" doors N/C

ANCHOR*

Optional welded-in drywall strap anchor Add \$25
*Required for narrow face 1 1/2" and 1 3/4" face frames

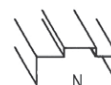
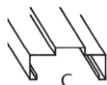
EXTRAS

NAILER frame (3 3/4" - 13") N Profile Add \$90

NOTE: Refer To Tech Page for maximum ratings and sizes

CURRISEAL FRAME (4 1/8" - 14")

Gasketed frame price includes gasket.

Available for 1 3/4" door

Maximum size 4080 / 8080 Add \$174

Head Add \$58

Jamb Add \$58

Additional gasket prices and stock numbers are listed in the Engineered Frame Section.

Drywall Double Egress frames not available as KD.

Price as CCW material - welded (SMO or SBE) construction only

DUTCH DOOR FRAME N/C

FOUR (4") INCH FACE HEADS (4 3/4" - 14") JAMB DEPTH

Available for 1 3/8" or 1 3/4" doors

Single including 4'0" Add \$57

Pairs over 4'0" Add \$80

GALVANNEAL (A40 & A60) FRAME ADDS

Price per frame piece \$10 \$18

Price per 3 Sided frame \$30 \$54

GALVANIZED (G-90)

Price per frame piece Add \$31

Price per 3 Sided frame Add \$93

FIRE FRAME LABELS

Warnock Hersey - Specify on order

Embossment; no hourly or 1 1/2 hour rating Standard

Metal label with hourly rating on hinge jamb Add \$29

Underwriters Laboratories

Prices are less closer (CL)

LESS

CL

Single Frame Add \$29

Double Frame Add \$58

EXTRAS

THERMAL BREAK FRAMES - NOT AVAILABLE

HARDWARE PREPARATIONS
CLOSER PREPARATIONS

Concealed closer Add \$267

Regular arm E10 Add \$30

Parallel arm E11 Add \$30

Half sleeve E18 Add \$38

Full sleeve E17 Add \$46

FLUSH BOLTS

Standard ANSI 115.4 H2 Add \$53

Reversible (strike plate included) H5 Add \$53

Reinforce only H1 Add \$30

HINGE PREPARATIONS

4 1/2" standard or heavyweight Standard

1 1/2 Pair up to and including 7'6" Standard

2 pair over 7'6" to 10'0" Standard

5" standard or heavyweight Add Each \$9

Full Surface mounted continuous hinge reinforcement Add \$80

High frequency reinforcement strap support

Per hinge Add \$24

HOLDERS

Overhead Concealed Add \$158

Overhead stop and holder surface mounted 14 ga. Add \$30

PIVOTS

Top and bottom set single acting Per Frame Add 153 \$248

Per Jamb Add \$103

Per head Add \$145

Intermediate pivot single acting Each Add \$87

PANIC EXIT REINFORCING

Rim type E8 Add \$30

Rim vertical rod surface mounted strike E5 Add \$30

Vertical rod mortise strike in head - Each G20 Add \$65

STRIKES

4 7/8" ANSI lipped strike E1 Standard

2 3/4" ANSI lipped strike E2 Standard

3 1/2" ANSI deadlock strike E3 Standard

2 3/4" ANSI deadlock strike E4 Standard

Electric strike frame E9 Add \$111

(includes cover box with knockout)

SURFACE BOLTS

Reinforcement only Add \$27

C-16 KD Borrowed Lites Frame Prices

May, 2024



BORROWED LITE K.D. (KNOCKED DOWN) C SERIES

FOR NEW CONSTRUCTION - NOTE: Installation is after the wall is up, rough opening size required is

2-1/2" larger than actual glass opening width and height

4" face members are not available

Drywall C-profile 16 gauge, compression anchors top and bottom horizontal members, 1-1/2", 1-3/4", 2" face. CG profile is available 2" face only

Add \$28.00 list for U.L. Label

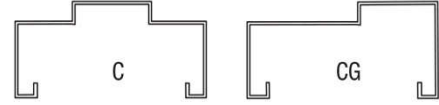

NOTE: Standard 5/8" x 5/8" glass stop is cut to length, punched, dimpled and shipped loose. Glass stop is punched 2" in from each end and 12" on center.

Price glass stop at \$6.00 list per foot. Self drilling #8 TEK screws for glass stop are included. Corner screws are furnished upon request at no charge.

WIDTH X HEIGHT	3 THRU 6	6-1/8 THRU 7- 7/8	8 THRU 9-7/8	10 THRU 11-7/8	12 THRU 14
	CR	CR	CR	CR	CR
1'6" min - 3'0" x 3'0"	\$245	\$269	\$335	\$367	\$405
1'6" min - 3'0" x 4'0"	\$275	\$303	\$379	\$417	\$461
1'6" min - 3'0" x 5'0"	\$306	\$338	\$424	\$467	\$517
1'6" min - 3'0" x 6'0"	\$337	\$373	\$469	\$516	\$572
3'1" - 4'0" x 3'0"	\$257	\$285	\$349	\$381	\$423
3'1" - 4'0" x 4'0"	\$287	\$319	\$393	\$431	\$479
3'1" - 4'0" x 5'0"	\$318	\$354	\$438	\$481	\$535
3'1" - 4'0" x 6'0"	\$349	\$389	\$483	\$530	\$590
4'1" - 6'0" x 3'0"	\$357	\$395	\$475	\$563	\$603
4'1" - 6'0" x 4'0"	\$387	\$429	\$519	\$613	\$659
4'1" - 6'0" x 5'0"	\$418	\$464	\$564	\$663	\$715
4'1" - 6'0" x 6'0"	\$449	\$499	\$609	\$712	\$770

GALVANNEAL (A40 & A60)

Add A40 \$40.00 A60 \$72.00

BORROWED LITE K.D. (KNOCKED DOWN) CK SERIES

FOR NEW CONSTRUCTION - NOTE: Installation is after the wall is up, rough opening size required is larger than actual glass opening

width and height. Drywall CK-profile 16 gauge, compression anchors top and bottom horizontal members, 2" face

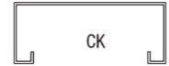

NOTE: Standard 5/8" x 5/8" glass stop is cut to length, punched, dimpled and shipped loose. Glass stop is punched 2" in from each end and 12" on center.

Price glass stop at \$6.00 list per foot. Self drilling #8 TEK screws for glass stop are included. Corner screws are furnished upon request at no charge.

WIDTH X HEIGHT	3 THRU 6	6-1/8 THRU 7- 7/8	8 THRU 9-7/8	10 THRU 11-7/8	12 THRU 14
	CR	CR	CR	CR	CR
1'6" min - 3'0" x 3'0"	\$263	\$287	\$353	\$385	\$423
1'6" min - 3'0" x 4'0"	\$293	\$321	\$397	\$435	\$479
1'6" min - 3'0" x 5'0"	\$324	\$356	\$442	\$485	\$535
1'6" min - 3'0" x 6'0"	\$355	\$391	\$487	\$534	\$590
3'1" - 4'0" x 3'0"	\$275	\$303	\$367	\$399	\$441
3'1" - 4'0" x 4'0"	\$305	\$337	\$411	\$449	\$497
3'1" - 4'0" x 5'0"	\$336	\$372	\$456	\$499	\$553
3'1" - 4'0" x 6'0"	\$367	\$407	\$501	\$548	\$608
4'1" - 6'0" x 3'0"	\$375	\$413	\$493	\$581	\$621
4'1" - 6'0" x 4'0"	\$405	\$447	\$537	\$631	\$677
4'1" - 6'0" x 5'0"	\$436	\$482	\$582	\$681	\$733
4'1" - 6'0" x 6'0"	\$467	\$517	\$627	\$730	\$788

GALVANNEAL (A40 & A60)

Add A40 \$40.00 A60 \$72.00

**C-14 KD Borrowed Lites
Frame Prices**

May, 2024

BORROWED LITE K.D. (KNOCKED DOWN) C SERIES

FOR NEW CONSTRUCTION - NOTE: Installation is after the wall is up, rough opening size required is 2-1/2" larger than actual glass opening width and height. 4" face members are not available.

Drywall C-profile 14 gauge, compression anchors top and bottom horizontal members, 2" face only. Add \$28.00 list for U.L. Label.

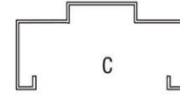

NOTE: Standard 5/8" x 5/8" glass stop is cut to length, punched, dimpled and shipped loose. Glass stop is punched 2" in from each end and 12" on centre
Price glass stop at \$6.00 list per foot. Self drilling #8 TEK screws for glass stop are included. Corner screws are furnished upon request at no charge.

WIDTH X HEIGHT	3 THRU 6	6-1/8 THRU 7 7/8	8 THRU 9-7/8	10 THRU 11-7/8	12 THRU 14
	CR	CR	CR	CR	CR
1'6" min - 3'0" x 3'0"	\$281	\$312	\$376	\$404	\$450
1'6" min - 3'0" x 4'0"	\$319	\$354	\$428	\$460	\$512
1'6" min - 3'0" x 5'0"	\$356	\$395	\$479	\$516	\$575
1'6" min - 3'0" x 6'0"	\$393	\$437	\$531	\$572	\$637
3'1" - 4'0" x 3'0"	\$305	\$332	\$400	\$430	\$470
3'1" - 4'0" x 4'0"	\$343	\$374	\$452	\$486	\$532
3'1" - 4'0" x 5'0"	\$380	\$415	\$503	\$542	\$595
3'1" - 4'0" x 6'0"	\$417	\$457	\$555	\$598	\$657
4'1" - 6'0" x 3'0"	\$417	\$458	\$536	\$622	\$666
4'1" - 6'0" x 4'0"	\$455	\$500	\$588	\$678	\$728
4'1" - 6'0" x 5'0"	\$492	\$541	\$639	\$734	\$791
4'1" - 6'0" x 6'0"	\$529	\$583	\$691	\$790	\$853

GALVANNEAL (A40 & A60)

Add

A40

\$40.00

A60

\$72.00

BORROWED LITE K.D. (KNOCKED DOWN) CK SERIES

FOR NEW CONSTRUCTION - NOTE: Installation is after the wall is up, rough opening size required is larger than actual glass opening width and height

Drywall CK-profile 14 gauge, compression anchors top and bottom horizontal members, 2" face



NOTE: Standard 5/8" x 5/8" glass stop is cut to length, punched, dimpled and shipped loose. Glass stop is punched 2" in from each end and 12" on centre
Price glass stop at \$6.00 list per foot. Self drilling #8 TEK screws are included. Corner screws for glass stop are furnished upon request at no charge.

WIDTH X HEIGHT	3 THRU 6	6-1/8 THRU 7 7/8	8 THRU 9-7/8	10 THRU 11-7/8	12 THRU 14
	CR	CR	CR	CR	CR
1'6" min - 3'0" x 3'0"	\$299	\$330	\$394	\$422	\$468
1'6" min - 3'0" x 4'0"	\$337	\$372	\$446	\$478	\$530
1'6" min - 3'0" x 5'0"	\$374	\$413	\$497	\$534	\$593
1'6" min - 3'0" x 6'0"	\$411	\$455	\$549	\$590	\$655
3'1" - 4'0" x 3'0"	\$323	\$350	\$418	\$448	\$488
3'1" - 4'0" x 4'0"	\$361	\$392	\$470	\$504	\$550
3'1" - 4'0" x 5'0"	\$398	\$433	\$521	\$560	\$613
3'1" - 4'0" x 6'0"	\$435	\$475	\$573	\$616	\$675
4'1" - 6'0" x 3'0"	\$435	\$476	\$554	\$640	\$684
4'1" - 6'0" x 4'0"	\$473	\$518	\$606	\$696	\$746
4'1" - 6'0" x 5'0"	\$510	\$559	\$657	\$752	\$809
4'1" - 6'0" x 6'0"	\$547	\$601	\$709	\$808	\$871

GALVANNEAL (A40 & A60)

Add

A40

\$40.00

A60

\$72.00

	WIDTH	HEIGHT	3 THRU 6	6-1/8 THRU 7-7/8	8 THRU 9-7/8		
SINGLES	1'6" THRU 3'0"	6'8"	\$260	\$288	\$342		
		7'	\$265	\$293	\$347		
		7'2"	\$286	\$314	\$368		
		8'	\$328	\$354	\$409		
	3'+ THRU 4'0"	6'8"	\$274	\$302	\$356		
		7'	\$279	\$307	\$361		
7'2"		\$300	\$328	\$382			
8'		\$342	\$368	\$423			
DOUBLES	4'+ THRU 6'0"	6'8"	\$331	\$369	\$442		
		7'	\$339	\$377	\$450		
		7'2"	\$357	\$391	\$468		
		8'	\$415	\$449	\$524		
	6'+ THRU 8'0"	6'8"	\$357	\$395	\$466		
		7'	\$365	\$403	\$474		
7'2"		\$383	\$417	\$492			
8'		\$441	\$475	\$548			
FRAME COMPONENT PART PRICES (NO ANCHORS)							
STRIKE JAMBS	6'8"	\$88	\$99	\$121			
	7'	\$89	\$100	\$122			
	7'2"	\$101	\$114	\$134			
	8'	\$111	\$122	\$144			
HINGE JAMBS	6'8"	\$97	\$110	\$130			
	7'	\$101	\$114	\$134			
	7'2"	\$110	\$121	\$143			
	8'	\$136	\$147	\$168			
HEADS	1'6" THRU 3'0"	\$57	\$61	\$73			
	3'+ THRU 4'0"	\$71	\$75	\$87			
	4'+ THRU 6'0"	\$119	\$131	\$164			
	6'+ THRU 8'0"	\$145	\$157	\$188			

GENERAL INFORMATION

CURRIES CM series frames are available double rabbet (equal or unequal), single rabbet or cased opening profile. Prices reflect hardware preparations for 1 3/4" doors. Refer to CURRIES Architectural Technical Data Manual for standard details and limitations. These frames are intended to be welded and installed prior to wall construction. This is a drywall profile frame without the compression anchor system. Wall anchors must be used.

All hinge jambs are available with Warnock Hersey Label embossment at no charge when specified on the order.

2" face unequal rabbet profile frames are standard. Double rabbet 1 1/2" and 1 3/4" face frames are priced the same as 2" face at no extra charge.

EXPANDED KD CAPABILITIES

Returns can vary 7/16" min. through 1" max (add 15%)

Rabbets can vary 5/8" min. and 6" max. for the non door rabbet.

Contact factory for bend limitations on any KD profiles with rabbets exceeding 6". A 15% add is applicable to frame price for returns and or rabbets.

Jamb depth ranges are listed above each column 1/8" increment jamb depths (all ranges 3" thru 14") are available at no extra charge.

ANCHORS - footclips are welded in place. Standard loose jamb anchors are included in these prices. 3 per jamb up to 7'6" and 4 per jamb over 7'6". Complete anchor information is listed in the Engineered Frame Section.

Welding charge only per anchor Add \$3
(Add for appropriate anchor)

EXTRAS

BUNDLING AND TAGGING FRAMES

Frame Order Code 3F, 3FH, 3FV, 2F, SL, BL, 4F
component bundling or welded frames Add \$6
Visual ID tag Add \$6

CASED OPENING FRAMES (4 1/2" - 14")

Per frame Add \$18
Per piece Add \$6
Cased opening price includes standard mortise hardware preparations, hinges and strikes or blank.

COMMUNICATING FRAME (4 7/8" - 14")

Available for 1 3/4" doors N/C

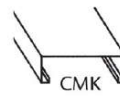
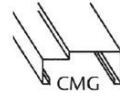
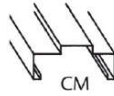

EXTRAS

CURRISEAL FRAME (4 1/8" - 14")

Gasketed frame price includes
Available for 1 3/4" door
Maximum size 4080 / 8080

Add	\$174
Head	Add \$58
Jamb	Add \$58

Additional gasket prices and stock numbers are listed in the Engineered Frame Section.

**Drywall Double Egress frames not available as KD.
Price as CCW material - welded (SMO or SBE) construction only**

DUTCH DOOR FRAME N/C

FOUR (4") INCH FACE HEADS (4-3/4" - 14")

Available for 1 3/8" or 1 3/4" doors

Single including 4'0"	Add	\$57
Pairs over 4'0"	Add	\$80

GALVANNEAL (A40 & A60) FRAME ADDS A40 A60

Price per frame piece	Add	\$10	\$18
Price per 3-Sided frame	Add	\$30	\$54

GALVANIZED (G-90)

Price per frame piece	Add	\$31
Price per 3 sided frame	Add	\$93

FIRE FRAME LABELS

Warnock Hersey - Specify on order

Embossment; no hourly or 1-1/2 hour rating	Standard
Metal label with hourly rating on hinge jamb	Add \$29

Underwriters Laboratories

Prices are less closer (CL)

	LESS
	<u>CL</u>
Single Frame	Add \$29
Double frame	Add \$58

EXTRAS

THERMAL BREAK FRAMES - NOT AVAILABLE

HARDWARE PREPARATIONS

CLOSER PREPARATIONS

Concealed closer		Add	\$267
Regular arm	E10	Add	\$30
Parallel arm	E11	Add	\$30
Half sleeve	E18	Add	\$38
Full sleeve	E17	Add	\$46

FLUSH BOLTS

Standard ANSI 115.4	H2	Add	\$53
Reversible (strike plate included)	H5	Add	\$53
Reinforce Only	H1	Add	\$30

HINGE PREPARATIONS

4 1/2" standard or heavyweight		Standard
1 1/2 pair up to and including 7'6"		Standard
2 pair over 7'6" to 10'0"		Standard
5" standard or heavyweight		Add Each \$9
Full surface mounted continuous hinge reinforcement		Add \$80
High frequency reinforcement strap support		
Per hinge		Add \$24

HOLDERS

Overhead concealed		Add	\$158
Overhead stop & holder surface mounted 14 ga		Add	\$30

PIVOTS

Top & bottom set single acting	Per frame	Add	\$248
	Per jamb	Add	\$103
	Per head	Add	\$145
Intermediate pivot single acting	Each	Add	\$87

PANIC EXIT REINFORCING

Rim Type	E8	Add	\$30
Rim vertical rod surface mounted strike	E5	Add	\$30
Vertical rod mortise strike in head - Each	G20	Add	\$65

STRIKES

4 7/8" ANSI lipped strike	E1	Standard
2 3/4" ANSI lipped strike	E2	Standard
3 1/2" ANSI deadlock strike	E3	Standard
2 3/4" ANSI deadlock strike	E4	Standard
Electric Strike frame	E9	Add \$111
(Includes cover box with knockout)		

SURFACE BOLTS

Reinforcement only		Add	\$27
--------------------	--	-----	------

WELDED ASSEMBLIES (3 SIDED FRAMED)

Seam Weld Die Miter (KD)	SW	Add	\$86
Full Weld Die Miter (KD)	FW	Add	\$154

	WIDTH	HEIGHT	3 THRU 6	6-1/8 THRU 7-7/8	8 THRU 9-7/8	10 THRU 11-7/8	12 THRU 14
SINGLES	1'6" THRU 3'0"	6'8"	\$277	\$302	\$358	\$406	\$467
		7'	\$281	\$305	\$361	\$409	\$471
		7'2"	\$301	\$328	\$384	\$430	\$493
		8'	\$346	\$373	\$429	\$475	\$539
		9'	\$370	\$400	\$454	\$503	\$563
	3' + THRU 4'0"	6'8"	\$291	\$316	\$371	\$419	\$482
		7'	\$295	\$319	\$374	\$422	\$486
		7'2"	\$315	\$342	\$397	\$443	\$508
		8'	\$360	\$387	\$442	\$488	\$554
		9'	\$384	\$414	\$467	\$516	\$578
DOUBLES	4' + THRU 6'0"	6'8"	\$356	\$389	\$465	\$518	\$601
		7'	\$362	\$393	\$469	\$522	\$607
		7'2"	\$376	\$411	\$487	\$540	\$625
		8'	\$438	\$473	\$549	\$602	\$687
		9'	\$470	\$509	\$583	\$638	\$719
	6' + THRU 8'0"	6'8"	\$382	\$413	\$490	\$542	\$626
		7'	\$388	\$417	\$494	\$546	\$632
		7'2"	\$402	\$435	\$512	\$564	\$650
		8'	\$464	\$497	\$574	\$626	\$712
		9'	\$496	\$533	\$608	\$662	\$744
8' + THRU 10'0"	6'8"	\$418	\$450	\$526	\$579	\$662	
	7'	\$424	\$454	\$530	\$583	\$668	
	7'2"	\$438	\$472	\$548	\$601	\$686	
	8'	\$500	\$534	\$610	\$663	\$748	
	9'	\$532	\$570	\$644	\$699	\$780	
	10'	\$570	\$604	\$678	\$733	\$818	
FRAME COMPONENT PART PRICES (NO ANCHORS)							
STRIKE JAMBS	6'8"	\$92	\$102	\$124	\$144	\$168	
	7'	\$93	\$103	\$125	\$145	\$169	
	7'2"	\$106	\$117	\$139	\$157	\$182	
	8'	\$117	\$128	\$150	\$168	\$194	
	9'	\$125	\$137	\$158	\$178	\$202	
HINGE JAMBS	6'8"	\$107	\$117	\$139	\$157	\$182	
	7'	\$110	\$119	\$141	\$159	\$185	
	7'2"	\$117	\$128	\$150	\$168	\$194	
	8'	\$145	\$156	\$178	\$196	\$222	
	9'	\$161	\$174	\$195	\$214	\$238	
	10'	\$180	\$191	\$212	\$231	\$257	
HEADS	1'6" THRU 3'0"	\$60	\$65	\$77	\$87	\$99	
	3'+ THRU 4'0"	\$74	\$79	\$90	\$100	\$114	
	4'+ THRU 6'0"	\$124	\$137	\$169	\$186	\$219	
	6'+ THRU 8'0"	\$150	\$161	\$194	\$210	\$244	
	8'+ THRU 10'0"	\$186	\$198	\$230	\$247	\$280	

GENERAL INFORMATION

CURRIES CM series frames are available double rabbet (equal or unequal), single rabbet or cased opening profile. Prices reflect hardware preparations for 1 3/4" doors.

Refer to CURRIES Architectural Technical Data Manual for standard details and limitations. These frames are intended to be welded and installed prior to wall construction. This is a drywall profile frame without the compression anchor system. Wall anchors must be used. All hinge jambs are available with Warnock Hersey Label embossment at no charge when specified on the order. 2" face unequal rabbet profile frames are standard. Double rabbet 1 1/2" and 1 3/4" face frames are priced the same as 2" face at no extra charge.

EXPANDED KD CAPABILITIES

Returns can vary 7/16" min. through 1" max (add 15%)
 Rabbets can vary 5/8" min. and 6" max. for the non door rabbet.
 Contact factory for bend limitations on any KD profiles with rabbets exceeding 6". A 15% add is applicable to frame price for returns and or rabbets.

Jamb depth ranges are listed above each column 1/8" increment jamb depths (all ranges 3" thru 14") are available at no extra charge.

ANCHORS - footclips are welded in place. Standard loose jamb anchors are included in these prices. 3 per jamb up to 7'6" and 4 per jamb over 7'6". Complete anchor information is listed in the Engineered Frame Section.

Welding charge only per anchor Add \$3
 (Add for appropriate anchor)

EXTRAS

BUNDLING AND TAGGING FRAMES

Frame Order Code 3F, 3FH, 3FV, 2F, SL, BL, 4F
 component bundling or welded frames Add \$6
 Visual ID tag Add \$6

CASED OPENING FRAMES (4 1/2" - 14")

Per frame Add \$18
 Per piece Add \$6
 Cased opening price includes standard mortise hardware preparations, hinges and strikes or blank.

COMMUNICATING FRAME (4 7/8" - 14")

Available for 1 3/4" doors N/C

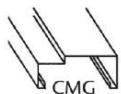
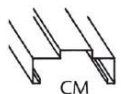
EXTRAS
CURRISEAL FRAME (4 1/8" - 14")

Gasketed frame price includes gasket.

Available for 1 3/4" door

Maximum size 4080 / 8080

Add \$174

Head Add \$58

Jamb Add \$58

Additional gasket prices and stock numbers are listed in the Engineered Frame Section.

Drywall Double Egress frames not available as KD.

Price as CCW material - welded (SMO or SBE) construction only

DUTCH DOOR FRAME N/C

FOUR (4") INCH FACE HEADS (4-3/4" - 14") JAMB

Available for 1 3/4" doors

Single including 4'0" Add \$57

Pairs over 4'0" Add \$80

GALVANNEAL (A40 & A60) FRAME ADDS

Price per frame piece Add \$10 \$18

Price per 3-Sided frame Add \$30 \$54

GALVANIZED (G-90)

Price per frame piece Add \$31

Price per 3 sided frame Add \$93

FIRE FRAME LABELS
Warnock Hersey - Specify on order

Embossment; no hourly or 1-1/2 hour rating Standard

Metal label with hourly rating on hinge jamb Add \$29

Underwriters Laboratories

Prices are less closer (CL)

LESS

CL

Single Frame Add \$29

Double frame Add \$58

EXTRAS
THERMAL BREAK FRAMES - NOT AVAILABLE
HARDWARE PREPARATIONS
CLOSER PREPARATIONS

Concealed closer		Add	\$267
Regular arm	E10	Add	\$30
Parallel arm	E11	Add	\$30
Half sleeve	E18	Add	\$38
Full sleeve	E17	Add	\$46

FLUSH BOLTS

Standard ANSI 115.4	H2	Add	\$53
Reversible (strike plate included)	H5	Add	\$53
Reinforce Only	H1	Add	\$30

HINGE PREPARATIONS

4 1/2" standard or heavyweight		Standard	
1 1/2 pair up to and including 7'6"		Standard	
2 pair over 7'6" to 10'0"		Standard	
5" standard or heavyweight		Add Each	\$9
Full surface mounted continuous hinge reinforcement		Add	\$80
High frequency reinforcement strap support			
Per hinge		Add	\$24

HOLDERS

Overhead concealed		Add	\$158
Overhead stop & holder surface mounted 14 ga		Add	\$30

PIVOTS

Top & bottom set single acting	Per frame	Add	\$248
	Per jamb	Add	\$103
	Per head	Add	\$145
Intermediate pivot single acting	Each	Add	\$87

PANIC EXIT REINFORCING

Rim Type	E8	Add	\$30
Rim vertical rod surface mounted strike	E5	Add	\$30
Vertical rod mortise strike in head - Each	G20	Add	\$65

STRIKES

4 7/8" ANSI lipped strike	E1	Standard	
2 3/4" ANSI lipped strike	E2	Standard	
3 1/2" ANSI deadlock strike	E3	Standard	
2 3/4" ANSI deadlock strike	E4	Standard	
Electric Strike frame	E9	Add	\$111
(Includes cover box with knockout)			

SURFACE BOLTS

Reinforcement only		Add	\$27
--------------------	--	-----	------

WELDED ASSEMBLIES (3 SIDED FRAMED)

Seam Weld Die Miter (KD)	SW	Add	\$86
Full Weld Die Miter (KD)	FW	Add	\$154

	WIDTH	HEIGHT	3 THRU 6	6-1/8 THRU 7-7/8	8 THRU 9-7/8	10 THRU 11-7/8	12 THRU 14
SINGLES	1'6" THRU 3'0"	6'8"	\$329	\$357	\$411	\$461	\$521
		7'	\$339	\$368	\$421	\$471	\$534
		7'2"	\$358	\$384	\$439	\$490	\$550
		8'	\$407	\$434	\$489	\$540	\$601
		9'	\$435	\$463	\$517	\$565	\$627
	10'	\$459	\$488	\$541	\$592	\$653	
	3' + THRU 4'0"	6'8"	\$342	\$369	\$423	\$474	\$533
		7'	\$352	\$380	\$433	\$484	\$546
		7'2"	\$371	\$396	\$451	\$503	\$562
		8'	\$420	\$446	\$501	\$553	\$613
9'		\$448	\$475	\$529	\$578	\$639	
10'	\$472	\$500	\$553	\$605	\$665		
DOUBLES	4' + THRU 6'0"	6'8"	\$425	\$462	\$533	\$592	\$671
		7'	\$435	\$474	\$547	\$604	\$687
		7'2"	\$451	\$486	\$561	\$618	\$699
		8'	\$515	\$552	\$625	\$684	\$765
		9'	\$549	\$584	\$659	\$714	\$795
	10'	\$579	\$614	\$687	\$746	\$829	
	6' + THRU 8'0"	6'8"	\$445	\$481	\$553	\$610	\$689
		7'	\$455	\$493	\$567	\$622	\$705
		7'2"	\$471	\$505	\$581	\$636	\$717
		8'	\$535	\$571	\$645	\$702	\$783
		9'	\$569	\$603	\$679	\$732	\$813
	10'	\$599	\$633	\$707	\$764	\$847	
	8' + THRU 10'0"	6'8"	\$486	\$522	\$594	\$652	\$731
		7'	\$496	\$534	\$608	\$664	\$747
		7'2"	\$512	\$546	\$622	\$678	\$759
8'		\$576	\$612	\$686	\$744	\$825	
9'		\$610	\$644	\$720	\$774	\$855	
10'	\$640	\$674	\$748	\$806	\$889		
FRAME COMPONENT PART PRICES (NO ANCHORS)							
STRIKE JAMBS	6'8"	\$111	\$122	\$145	\$164	\$188	
	7'	\$116	\$127	\$148	\$168	\$193	
	7'2"	\$127	\$137	\$159	\$180	\$203	
	8'	\$141	\$151	\$174	\$194	\$218	
	9'	\$152	\$164	\$185	\$204	\$229	
	10'	\$161	\$174	\$195	\$215	\$238	
HINGE JAMBS	6'8"	\$127	\$139	\$159	\$180	\$203	
	7'	\$132	\$145	\$166	\$186	\$211	
	7'2"	\$140	\$151	\$173	\$193	\$217	
	8'	\$169	\$181	\$202	\$223	\$247	
	9'	\$186	\$197	\$219	\$238	\$262	
	10'	\$201	\$212	\$233	\$254	\$279	
HEADS	1'6" THRU 3'0"	\$73	\$78	\$89	\$99	\$112	
	3'+ THRU 4'0"	\$86	\$90	\$101	\$112	\$124	
	4'+ THRU 6'0"	\$153	\$166	\$197	\$214	\$247	
	6'+ THRU 8'0"	\$173	\$185	\$217	\$232	\$265	
	8'+ THRU 10'0"	\$214	\$226	\$258	\$274	\$307	

GENERAL INFORMATION

CURRIES CM series frames are available double rabbet (equal or unequal), single rabbet (2" face X 2 5/8" face),or cased opening profile. Prices reflect hardware preparations for 1 3/4" doors. Refer to CURRIES Arch. Technical Data Manual for standard details and limitations. These frames are intended to be welded and installed prior to wall construction. This is a drywall profile frame without the compression anchor system. Wall anchors must be used.

All hinge jambs are available with Warnock Hersey Label embossment at no charge when specified on the order.

2" face unequal rabbet profile frames are standard. 14 ga. narrow face is not available K.D.

EXPANDED KD CAPABILITIES

Returns can vary 1/2" min. through 1" max (add 15%)
Rabbets can vary 5/8" min. and 6" max. for the non door rabbet.
Contact factory for bend limitations on any KD profiles with rabbets exceeding 6". A 15% add is applicable to frame price for returns and or rabbets.

Jamb dept.h ranges are listed above each column 1/8" increment jamb depths (all ranges 3" thru 14") are available at no extra charge.

ANCHORS - footclips are welded in place. Standard loose jamb anchors are included in these prices. 3 per jamb up to 7'6" and 4 per jamb over 7'6". Complete anchor information is listed in the Engineered Frame Section.

Welding charge only per anchor Add \$3
(Add for appropriate anchor)

EXTRAS

BUNDLING AND TAGGING FRAMES

Frame Order Code 3F, 3FH, 3FV, 2F, SL, BL, 4F
component bundling or welded frames Add \$6
Visual ID tag Add \$6

CASED OPENING FRAMES (4 1/2" - 14")

Per frame Add \$18
Per piece Add \$6
Cased opening price includes standard mortise hardware preparations, hinges and strikes or blank.

COMMUNICATING FRAME (4 7/8" - 14")

Available for 1 3/4" doors N/C

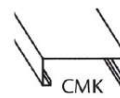
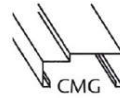
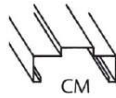
EXTRAS
CURRISEAL FRAME (4 1/8" - 14")

Gasketed frame price includes gasket.

Available for 1 3/4" door

Maximum size 4080 / 8080

Head Add \$174

Head Add \$58

Jamb Add \$58

Additional gasket prices and stock numbers are listed in the Engineered Frame Section.

Drywall Double Egress frames not available as KD.
Price as CCW material - welded (SMO or SBE) construction only
DUTCH DOOR FRAME

N/C

FOUR (4") INCH FACE HEADS (4-3/4" - 14") JAMB DEPTH

Available for 1 3/4" doors

Single including 4'0" Add \$57

Pairs over 4'0" Add \$80

GALVANNEAL (A40 & A60) FRAME ADDS

	A40	A60
Price per frame piece	Add \$10	\$18
Price per 3-Sided frame	Add \$30	\$54

GALVANIZED (G-90)

Price per frame piece Add \$31

Price per 3 sided frame Add \$93

FIRE FRAME LABELS
Warnock Hersey - Specify on order

Embossment; no hourly or 1-1/2 hour rating Standard

Metal label with hourly rating on hinge jamb Add \$29

Underwriters Laboratories

Prices are less closer (CL)

	LESS
	<u>CL</u>

Single Frame Add \$29

Double frame Add \$58

EXTRAS
THERMAL BREAK FRAMES - NOT AVAILABLE
HARDWARE PREPARATIONS
CLOSER PREPARATIONS

Concealed closer Add \$267

Regular arm E10 Add \$30

Parallel arm E11 Add \$30

Half sleeve E18 Add \$38

Full sleeve E17 Add \$46

FLUSH BOLTS

Standard ANSI 115.4 H2 Add \$53

Reversible (strike plate included) H5 Add \$53

Reinforce Only H1 Add \$30

HINGE PREPARATIONS

4 1/2" standard or heavyweight Standard

1 1/2 pair up to and including 7'6" Standard

2 pair over 7'6" to 10'0" Standard

5" standard or heavyweight Add Each \$9

Full surface mounted continuous hinge reinforcement Add \$80

High frequency reinforcement strap support

Per hinge Add \$24

HOLDERS

Overhead concealed Add \$158

Overhead stop & holder surface mounted 14 ga Add \$30

PIVOTS

Top & bottom set single acting Per frame Add \$248

Per jamb Add \$103

Per head Add \$145

Intermediate pivot single acting Each Add \$87

PANIC EXIT REINFORCING

Rim Type E8 Add \$30

Rim vertical rod surface mounted strike E5 Add \$30

Vertical rod mortise strike in head - Each G20 Add \$65

STRIKES

4 7/8" ANSI lipped strike E1 Standard

2 3/4" ANSI lipped strike E2 Standard

3 1/2" ANSI deadlock strike E3 Standard

2 3/4" ANSI deadlock strike E4 Standard

Electric Strike frame E9 Add \$111

(Includes cover box with knockout)

SURFACE BOLTS

Reinforcement only Add \$27

WELDED ASSEMBLIES (3 SIDED FRAMED)

Seam Weld Die Miter (KD) SW Add \$86

Full Weld Die Miter (KD) FW Add \$154

ADJ Series Frames - 14 Ga. STC Frame

STC Frame Prices

May, 2024

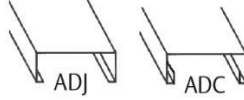

	WIDTH	HEIGHT	3 1/2 THRU 6	6-1/8 THRU 7-7/8	8 THRU 9-7/8	10 THRU 11-7/8	12 THRU 14
SINGLES	1'6" THRU 3'0"	6'8"	\$977	\$1,003	\$1,048	\$1,097	\$1,153
		7'	\$984	\$1,015	\$1,057	\$1,112	\$1,166
		7'2"	\$1,001	\$1,020	\$1,063	\$1,117	\$1,172
		8'	\$1,030	\$1,056	\$1,091	\$1,146	\$1,202
		9'	\$1,061	\$1,088	\$1,132	\$1,180	\$1,241
	3' + THRU 4'0"	6'8"	\$990	\$1,008	\$1,057	\$1,104	\$1,159
		7'	\$997	\$1,020	\$1,066	\$1,119	\$1,172
		7'2"	\$1,014	\$1,025	\$1,072	\$1,124	\$1,178
		8'	\$1,043	\$1,061	\$1,100	\$1,153	\$1,208
		9'	\$1,074	\$1,093	\$1,141	\$1,187	\$1,247
DOUBLES	4' + THRU 6'0"	6'8"	\$1,044	\$1,064	\$1,111	\$1,162	\$1,214
		7'	\$1,048	\$1,074	\$1,117	\$1,174	\$1,228
		7'2"	\$1,066	\$1,080	\$1,125	\$1,178	\$1,232
		8'	\$1,108	\$1,130	\$1,169	\$1,224	\$1,280
		9'	\$1,140	\$1,164	\$1,211	\$1,256	\$1,318
	6' + THRU 8'0"	6'8"	\$1,058	\$1,078	\$1,135	\$1,181	\$1,235
		7'	\$1,062	\$1,088	\$1,141	\$1,193	\$1,249
		7'2"	\$1,080	\$1,094	\$1,149	\$1,197	\$1,253
		8'	\$1,122	\$1,144	\$1,193	\$1,243	\$1,301
		9'	\$1,154	\$1,178	\$1,235	\$1,275	\$1,339

GENERAL INFORMATION

ADJ series frames are available in cased opening. Prices reflect hardware preparations for 1 3/4" doors. Refer to CURRIES Architectural Technical Data Manual for standard details and limitations.

Miter, notch, and FW welding charges are included with these list prices on this page.

NOTE: 5-3/4" jamb depth frames have 1/2" minimum back bend. 7/16" N.A.

2" face frames are standard. 1", 1 1/4", 1 1/2", & 1 3/4" face

frames are priced the same as 2" face at no extra charge.

Jamb depth ranges are listed above each column. 1/8" increment jamb depths (all ranges 3 1/2" thru 14") are

ANCHORS - foot clips are welded in place

Standard loose jamb anchors are included in these prices.

3 per jamb up to 7'6" and 4 per jamb over 7'6". Complete anchor information is listed in the Engineered Frame Section

Welding charge only per anchor Add \$3
(Add for appropriate anchor)

EXTRAS

BUNDLING AND TAGGING FRAMES

Frame Order Code 3F, 3FH, 3FV, 2F, SL, BL, and 4F

Welded Frames Add \$6

NON STANDARD SIZE FRAMES

Price as the next largest standard size frame

For M frame pricing, refer to M frame section Up to STC 52

ST FRAME STC55 Add to ADJ frame ST Factory Quoted
6-3/4" min. jamb depth

CSM FRAME STC56-66 Add to ADJ frame CS Factory Quoted
11" min jamb depth

NOTE: This product is manufactured offsite and ships separately
Call to verify lead-times, freight cost, and ship schedule

ADJ Series Frames - 14 Ga STC Frame
STC Frame Prices

May, 2024

EXTRAS		
FOUR (4") INCH FACE HEADS		
Available for 1 3/4" door		
Single including 4'0"	Add	\$57
Pairs over 4'0"	Add	\$80
GALVANNEAL (A40 & A60) FAME ADDS		
		<u>A40</u> <u>A60</u>
Price per 3 sided frame	Add	\$30 \$54
GALVANIZED (G-90)		
Price per 3 Sided frame	Add	\$93
FIRE FRAME LABELS		
UNDERWRITERS LABORATORIES		
Prices are less closer (CL)		
		LESS
		<u>CL</u>
Single frame	Add	\$29
Double frame	Add	\$58

EXTRAS		
HARDWARE PREPARATIONS		
CLOSER PREPARATIONS		
Regular arm	E10	Add \$30
Parallel arm	E11	Add \$30
Half Sleeve	E18	Add \$38
Full Sleeve	E17	Add \$46
FLUSH BOLTS		
Standard ANSI 115.4	H2	Add \$53
Reversible (strike plate included)	H5	Add \$53
Reinforce only	H1	Add \$30
HINGE PREPARATIONS		
3 1/2" 1 pair or 1 1/2 pair		Standard
4 1/2" standard or heavyweight		Standard
1 1/2 pair up to and including 7'6"		Standard
2 pair over 7'6" to 8'0"		Standard
5" standard or heavyweight		Add Each \$9
Full surface mounted continuous hinge reinforcement		Add \$80
High frequency reinforcement strap support		
Per hinge		Add \$24
HOLDERS		
Overhead stop and holder surface mounted 14 ga		Add \$30
PIVOTS		
Top and bottom set single acting	Per frame	Add \$248
	Per jamb	Add \$103
	Per head	Add \$145
Intermediate pivot single acting	Each	Add \$87
PANIC EXIT REINFORCING		
Rim type	E8	Add \$30
Rim vertical rod surface mounted strike	E5	Add \$30
Vertical rod mortise strike in head - Each	G20	Add \$65
STRIKES		
4 7/8" ANSI lipped strike 1 3/4" door	E1	Standard
2 3/4" ANSI lipped strike 1 3/4" door	E2	Standard
3 1/2" ANSI deadlock strike 1 3/4" door	E3	Standard
2 3/4" ANSI deadlock strike 1 3/4" door	E4	Standard
Electric strike frame	E9	Add \$111
(includes cover box with knockout)		
SURFACE BOLTS		
Reinforcement only		Add \$27

E119 Fire Resistive Frames Frame Prices

May, 2024



E119 Fire Resistive Glazing Maximum Sizes*

Glass Type	UL Fire Rating	Visible Glass Width x Height	Max sq. inch	Glass Thickness
Contraflam 60	60 Minute	94-13/16" x 94-13/16"	3283	1-1/8"
Contraflam Structure 60	60 Minute	138-1/2" x 138-1/2"	7574	1-1/4"
Contraflam 90	90 Minute	94-13/16" x 94-13/16"	4435	1-7/16"
Contraflam 120	2 Hour	94-5/8" x 94-5/8"	4435	1-9/16"
Contraflam Structure	2 Hour	126" x 126"	4536	2-1/16"
Contraflam 180	3 hour	48" x 48"	2304	3-1/2"

*No maximum overall unit size. Units are tested as walls.

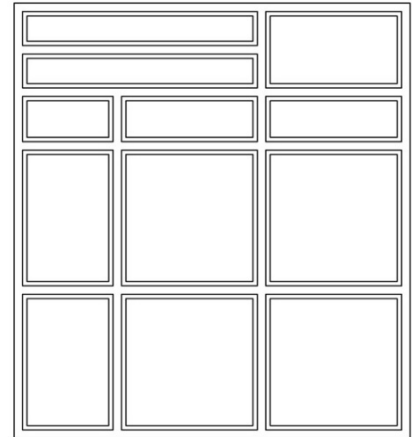

Transoms and sidelights also available.

CONTRAFLAM 60 CONTRAFLAM 120

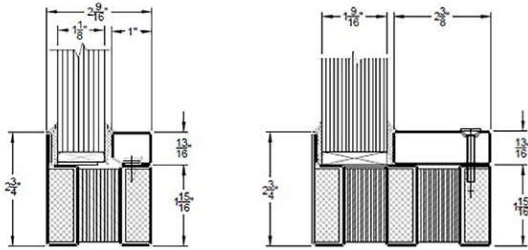

CONTRAFLAM 90

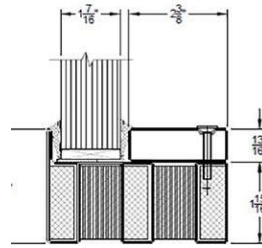

CONTRAFLAM 180

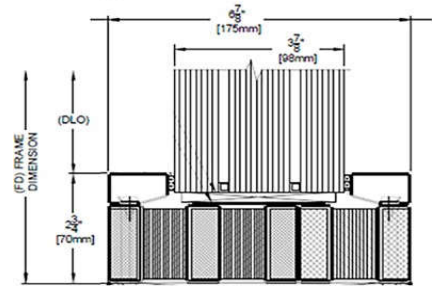

PLEASE USE THE E119 QUOTE FORM TO REQUEST A QUOTE.

DESCRIPTION	PAGE	PAGE
M-16 CCW Flush Sticks		
10'6" Lengths - Stock Only		2-3
M-16 CCW Flush Sticks		
Per Foot Pricing		4-5
M-14 CCW Flush Sticks		
10'6" Lengths - Stock Only		6-7
M-14 CCW Flush Sticks		
Per Foot Pricing		8-9
M-12 CCW Flush Sticks		
10'6" Lengths - Stock Only		10-11
M-12 CCW Flush Sticks		
Per Foot Pricing		12-13
Estimating CCW per Foot		
M-16 gauge		14
M-14 gauge		15
Glass Stops		
18 and 16 gauge		16
12 gauge		17
Cut and Notch Descriptions		18
Pricing Examples of Factory Cut and Notch Frames		19-22
Welded Assemblies		23-25
Closed Profile Seam Pricing		26

**M-16 CCW Flush Sticks-2" Face
10'6" Lengths – Stock Only**

CCW Flush Stick Prices

May, 2024

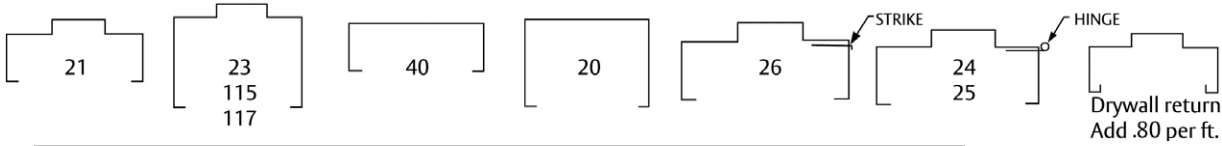

CCW NO.	ITEM NAME	DIMENSION	M 5-3/4	3 THRU 6	6-1/8 THRU 7-7/8	8 THRU 9-7/8	10 THRU 11-7/8	12 THRU 14
			CRS	CRS	CRS	CRS	CRS	CRS
21	Plain Rail		\$140	\$148	\$170	\$200	\$233	\$268
23	Plain Rail	4" Face	\$175	\$183	\$206	\$235	\$268	\$303
115	Plain Rail	6" Face	\$210	\$221	\$256	\$299	\$349	\$402
117	Plain Rail	8" Face	\$210	\$221	\$256	\$299	\$349	\$402
40	Cased Open		\$151	\$159	\$182	\$211	\$244	\$279
20	Cased Open	4" Face	\$187	\$194	\$217	\$246	\$279	\$314
26	Strike Jamb	All	\$153	\$166	\$188	\$218	\$251	\$286
24	Hinge Jamb	6'8"	\$194	\$202	\$224	\$254	\$287	\$322
25	Hinge Jamb	7'0"						
39	Hinge Jamb	7'2"						
62	Hinge Jamb	7'10"						
63	Hinge Jamb	8'0"	\$212	\$220	\$242	\$272	\$305	\$340
119	Hinge Jamb	9'0"						
120	Hinge Jamb	10'0"						

GALVANNEAL (A40 & A60)		A40	A60
	Add	\$18.48	\$33.39
GALVANIZED (G-90)	Add		\$64.89

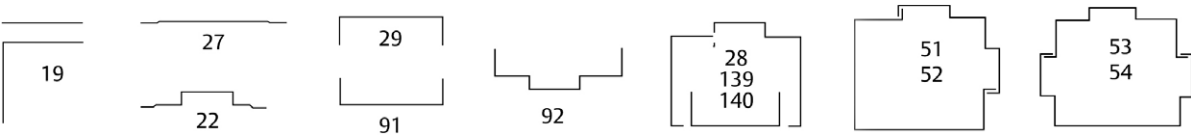

CCW NO.	ITEM NAME	DIMENSION	3 THRU 6	6-1/8 THRU 7-7/8	8 THRU 9-7/8	10 THRU 11-7/8	12 THRU 14
			CRS	CRS	CRS	CRS	CRS
19	Cover Plate (Flat Corner)		\$125	\$145	\$170	\$198	\$228
27	Filler Plate w/out Stop		\$167	\$193	\$225	\$263	\$303
22	Filler Plate with Stop		\$167	\$193	\$225	\$263	\$303
29	Head Cap		\$199	\$230	\$269	\$314	\$362
91	Channel Head Reinf.		\$199	\$230	\$269	\$314	\$362
92	Full Width Head Reinf.		\$148	\$170	\$200	\$233	\$268
28	Full Jamb Depth	4" Face	\$457	\$514	\$587	\$670	\$758
139	Full Jamb Depth	6" Face	\$554	\$639	\$748	\$873	\$1,005
140	Full Jamb Depth	8" Face					
51	2-Way Corner	1-9/16" O.S.	\$539	\$622	\$728	\$850	\$978
52	2-Way Corner	1-15/16" O.S.					
53	3-Way Corner	1-9/16" O.S.	\$605	\$699	\$818	\$955	\$1,099
54	3-Way Corner	1-15/16" O.S.					

GALVANNEAL (A40 & A60)		A40	A60
Open Sections	Add	\$18.48	\$33.39
Closed Sections	Add	\$36.96	\$66.78
GALVANIZED (G-90)			
Open Sections	Add		\$64.89
Closed Sections	Add		\$129.78

1", 1-1/4", 1-1/2", 1-3/4" face available — no charge.

18 gauge CCW price is - 10% deduct from 16 gauge price.

NOTE: Faces over 7", maximum rail length is 120"

**M-16 CCW Flush Sticks - 2" Face
10'6" Lengths – Stock Only
CCW Flush Stick Prices**

May, 2024

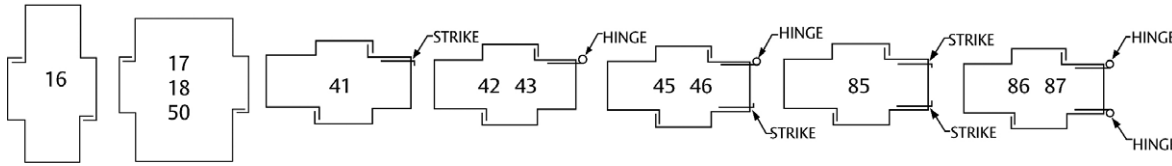

CCW NO.	MULLION TYPE	DIMENSION	3 THRU 6	6-1/8 THRU 7-7/8	8 THRU 9-7/8	10 THRU 11-7/8	12 THRU 14
			CRS	CRS	CRS	CRS	CRS
16	Plain		\$332	\$383	\$448	\$523	\$603
17	Plain	4" Face	\$408	\$471	\$552	\$644	\$741
18	Plain	6" Face	\$518	\$599	\$701	\$818	\$941
50	Plain	8" Face	\$518	\$599	\$701	\$818	\$941
41	Strike	All	\$350	\$401	\$466	\$541	\$621
42	Single Hinge	6'8"	\$386	\$437	\$502	\$577	\$657
43	Single Hinge	7'0"					
44	Single Hinge	7'2"					
81	Single Hinge	7'10"	\$404	\$455	\$520	\$595	\$675
82	Single Hinge	8'0"					
133	Single Hinge	9'0"					
134	Single Hinge	10'0"					
45	Hinge & Strike	6'8"	\$404	\$455	\$520	\$595	\$675
46	Hinge & Strike	7'0"					
47	Hinge & Strike	7'2"					
83	Hinge & Strike	7'10"	\$422	\$473	\$538	\$613	\$693
84	Hinge & Strike	8'0"					
135	Hinge & Strike	9'0"					
136	Hinge & Strike	10'0"					
85	Double Strike	All	\$368	\$419	\$484	\$559	\$639
86	Double Hinge	6'8"	\$440	\$491	\$556	\$631	\$711
87	Double Hinge	7'0"					
88	Double Hinge	7'2"					
89	Double Hinge	7'10"	\$476	\$527	\$592	\$667	\$747
90	Double Hinge	8'0"					
137	Double Hinge	9'0"					
138	Double Hinge	10'0"					

GALVANNEAL (A40 & A60)
Closed Sections Add A40 A60
\$36.96 \$66.78

GALVANIZED (G-90)
Closed Sections Add \$129.78

1", 1-1/4", 1-1/2", 1-3/4" face available — no charge.
18 gauge price is - 10% deduct from 16 gauge price.
NOTE: Faces over 7", maximum rail length is 120"
CCW 16 maximum length 126"

M-16 CCW Flush Stick - 2" Face

CCW Flush Stick Prices

May, 2024

PER FOOT PRICING - "ESTIMATING"

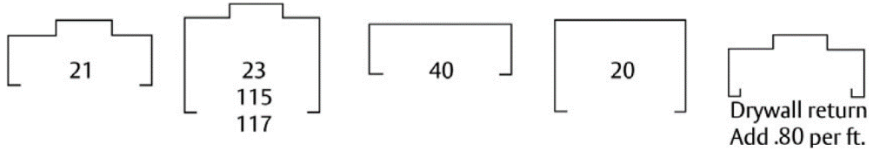

	CCW NO.	ITEM NAME	DIMENSION	M 5-3/4	3 THRU 6	6-1/8 THRU 7-7/8	8 THRU 9-7/8	10 THRU 11-7/8	12 THRU 14
				CRS	CRS	CRS	CRS	CRS	CRS
OPEN SECTION	21	Plain Rail		\$13.35	\$14.06	\$16.24	\$19.00	\$22.18	\$25.53
	23	Plain Rail	4" Face	\$16.71	\$17.41	\$19.59	\$22.35	\$25.53	\$28.88
	115	Plain Rail	6" Face	\$20.03	\$21.09	\$24.35	\$28.50	\$33.26	\$38.29
	117	Plain Rail	8" Face	\$20.03	\$21.09	\$24.35	\$28.50	\$33.26	\$38.29
	40	Cased Open		\$14.41	\$15.12	\$17.29	\$20.06	\$23.24	\$26.59
	20	Cased Open	4" Face	\$17.76	\$18.47	\$20.65	\$23.41	\$26.59	\$29.94

GALVANNEAL (A40 & A60) **A40** **A60**
 Price per Foot Add \$1.76 \$3.18

GALVANIZED (G-90) Add \$6.18



	CCW NO.	ITEM NAME	DIMENSION	3 THRU 6	6-1/8 THRU 7-7/8	8 THRU 9-7/8	10 THRU 11-7/8	12 THRU 14
				CRS	CRS	CRS	CRS	CRS
MISCELLANEOUS	19	Cover Plate (Flat Corner)		\$11.95	\$13.80	\$16.15	\$18.85	\$21.70
	27	Filler Plate w/out Stop		\$15.89	\$18.35	\$21.47	\$25.06	\$28.85
	22	Filler Plate with Stop		\$15.89	\$18.35	\$21.47	\$25.06	\$28.85
	29	Head Cap		\$18.98	\$21.92	\$25.65	\$29.94	\$34.46
	91	Channel Head Reinf.		\$18.98	\$21.92	\$25.65	\$29.94	\$34.46
	92	Full Width Head Reinf.		\$14.06	\$16.24	\$19.00	\$22.18	\$25.53
	28	Full Jamb Depth	4" Face	\$43.53	\$48.97	\$55.88	\$63.82	\$72.21
	139	Full Jamb Depth	6" Face	\$52.72	\$60.88	\$71.25	\$83.16	\$95.74
	140	Full Jamb Depth	8" Face					
	51	2-Way Corner	1-9/16" O.S.	\$51.31	\$59.26	\$69.35	\$80.94	\$93.18
	52	2-Way Corner	1-15/16" O.S.					
	53	3-Way Corner	1-9/16" O.S.	\$57.64	\$66.56	\$77.90	\$90.92	\$104.67
	54	3-Way Corner	1-15/16" O.S.					

GALVANNEAL (A40 & A60) **A40** **A60**
 Open Sections Add \$1.76 \$3.18
 Closed Sections Add \$3.52 \$6.36

GALVANIZED (G-90)
 Open Sections Add \$6.18
 Closed Sections Add \$12.36

4-1/2" hinge or standard (E1, E2, E3, E4) strike preparations will be added to these stick prices for \$17.00 list per each preparation.

1", 1-1/4", 1-1/2", 1-3/4" face available — no charge.

18 gauge CCW price is - 10% deduct from 16 gauge price.

**M-16 CCW Flush Sticks - 2" Face
CCW Flush Stick Prices**

May, 2024

PER FOOT PRICING - "ESTIMATING"

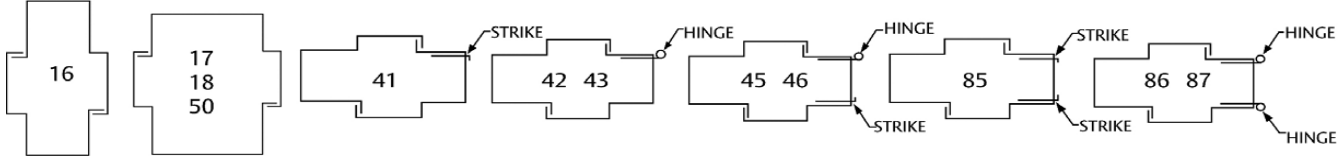

CLOSED SECTION MULLION	CCW NO.	MULLION TYPE	DIMENSION	3 THRU 6		6-1/8 THRU 7-7/8		8 THRU 9-7/8		10 THRU 11-7/8		12 THRU 14		GALVANNEAL (A40 & A60)	Price per Foot	Add	A40	A60
				CRS	CRS	CRS	CRS	CRS	CRS	CRS	CRS							
	16	Plain		\$31.60	\$36.50	\$42.71	\$49.85	\$57.39										
	17	Plain	4" Face	\$38.87	\$44.89	\$52.54	\$61.32	\$70.59										
	18	Plain	6" Face	\$49.37	\$57.01	\$66.72	\$77.87	\$89.65										
	50	Plain	8" Face	\$49.37	\$57.01	\$66.72	\$77.87	\$89.65										
														GALVANIZED (G-90)				\$12.36

4-1/2" hinge or standard (E1, E2, E3, E4) strike preparations will be added to these stick prices for \$17.00 list per each preparation.

1", 1-1/4", 1-1/2", 1-3/4" face available — no charge.

18 gauge price is - 10% deduct from 16 gauge price.

CCW 16 maximum length 126"

ESTIMATING COST PER INCH CCW ONLY

Multiply the cost per foot by the following conversion factor:

1"=.083	2"=.167	3"=.250	4"=.333	5"=.417	6"=.50	7"=.583	8"=.667	9"=.750	10"=.834	11"=.917
---------	---------	---------	---------	---------	--------	---------	---------	---------	----------	----------

M-14 CCW Flush Sticks-2" Face

10'6" Lengths – Stock Only

CCW Flush Stick Prices



May, 2024

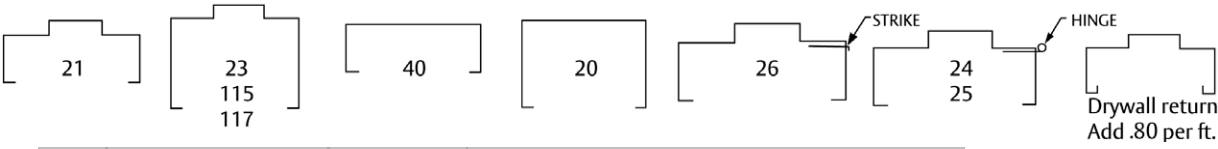

CCW NO.	ITEM NAME	DIMENSION	M 5-3/4	3 THRU 6	6-1/8 THRU 7-7/8	8 THRU 9-7/8	10 THRU 11-7/8	12 THRU 14
			CRS	CRS	CRS	CRS	CRS	CRS
21	Plain Rail		\$182	\$190	\$211	\$242	\$276	\$309
23	Plain Rail	4" Face	\$217	\$225	\$246	\$277	\$311	\$344
115	Plain Rail	6" Face	\$273	\$285	\$317	\$362	\$414	\$463
117	Plain Rail	8" Face	\$273	\$285	\$317	\$362	\$414	\$463
40	Cased Open		\$191	\$200	\$221	\$251	\$285	\$318
20	Cased Open	4" Face	\$227	\$235	\$256	\$286	\$321	\$353
26	Strike Jamb	All	\$200	\$208	\$229	\$260	\$294	\$327
24	Hinge Jamb	6"8"						
25	Hinge Jamb	7"0"	\$236	\$244	\$265	\$296	\$330	\$363
39	Hinge Jamb	7"2"						
62	Hinge Jamb	7"10"						
63	Hinge Jamb	8"0"	\$254	\$262	\$283	\$314	\$348	\$381
119	Hinge Jamb	9"0"						
120	Hinge Jamb	10"0"						

GALVANNEAL (A40 & A60) A40 A60
 Add \$18.48 \$33.39

GALVANIZED (G-90) Add \$64.89

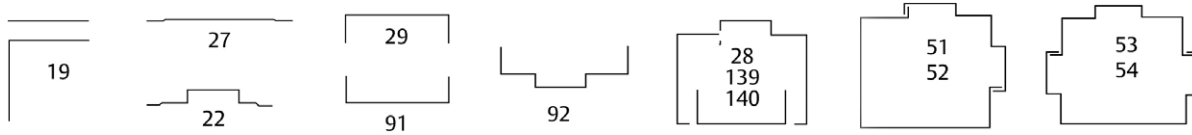

CCW NO.	ITEM NAME	DIMENSION	3 THRU 6	6-1/8 THRU 7-7/8	8 THRU 9-7/8	10 THRU 11-7/8	12 THRU 14
			CRS	CRS	CRS	CRS	CRS
19	Cover Plate (Flat Corner)		\$158	\$175	\$200	\$229	\$256
27	Filler Plate w/out Stop		\$209	\$230	\$263	\$301	\$337
22	Filler Plate with Stop		\$209	\$232	\$266	\$304	\$340
29	Head Cap		\$257	\$285	\$326	\$373	\$417
91	Channel Head Reinf.		\$257	\$285	\$326	\$373	\$417
92	Full Width Head Reinf.		\$190	\$211	\$242	\$276	\$309
28	Full Jamb Depth	4" Face	\$597	\$653	\$733	\$825	\$912
139	Full Jamb Depth	6" Face	\$756	\$840	\$960	\$1,097	\$1,228
140	Full Jamb Depth	8" Face					
51	2-Way Corner	1-9/16" O.S.	\$666	\$739	\$845	\$966	\$1,081
52	2-Way Corner	1-15/16" O.S.					
53	3-Way Corner	1-9/16" O.S.	\$789	\$877	\$1,002	\$1,146	\$1,282
54	3-Way Corner	1-15/16" O.S.					

GALVANNEAL (A40 & A60) A40 A60

Open Sections Add \$18.48 \$33.39

Closed Sections Add \$36.96 \$66.78

GALVANIZED (G-90)

Open Sections Add \$64.89

Closed Sections Add \$129.78

1", 1-1/4", 1-1/2", 1-3/4" face available — no charge.

18 gauge CCW price is - 10% deduct from 16 gauge price.

NOTE: Faces over 7", maximum rail length is 120"

**M-14 CCW Flush Sticks 2" Face
10'6" Lengths – Stock Only**

CCW Flush Stick Prices

May, 2024

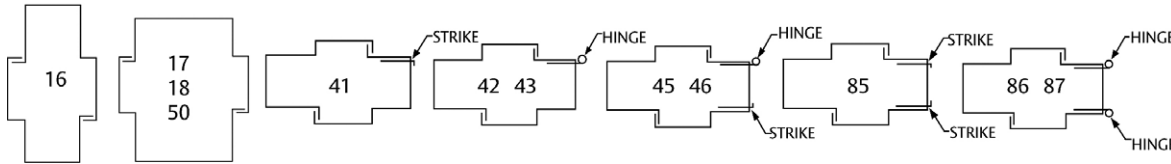

CCW NO.	MULLION TYPE	DIMENSION	3 THRU 6	6-1/8 THRU 7-7/8	8 THRU 9-7/8	10 THRU 11-7/8	12 THRU 14
			CRS	CRS	CRS	CRS	CRS
CLOSED SECTION MULLION	16	Plain	\$402	\$446	\$510	\$583	\$653
	17	Plain	4" Face	\$482	\$536	\$612	\$700
	18	Plain	6" Face	\$579	\$643	\$735	\$840
	50	Plain	8" Face	\$579	\$643	\$735	\$840
	41	Strike	All	\$420	\$464	\$528	\$601
	42	Single Hinge	6'8"	\$456	\$500	\$564	\$637
	43	Single Hinge	7'0"				
	44	Single Hinge	7'2"				
	81	Single Hinge	7'10"	\$474	\$518	\$582	\$655
	82	Single Hinge	8'0"				
	133	Single Hinge	9'0"				
	134	Single Hinge	10'0"	\$474	\$518	\$582	\$655
	45	Hinge & Strike	6'8"				
	46	Hinge & Strike	7'0"				
	47	Hinge & Strike	7'2"	\$492	\$536	\$600	\$673
	83	Hinge & Strike	7'10"				
	84	Hinge & Strike	8'0"				
	135	Hinge & Strike	9'0"	\$510	\$554	\$618	\$691
	136	Hinge & Strike	10'0"				
	85	Double Strike	All				
86	Double Hinge	6'8"	\$546	\$590	\$654	\$727	
87	Double Hinge	7'0"					
88	Double Hinge	7'2"					
89	Double Hinge	7'10"	\$546	\$590	\$654	\$727	
90	Double Hinge	8'0"					
137	Double Hinge	9'0"					
138	Double Hinge	10'0"					

GALVANNEAL (A40 & A60)
Closed Sections Add A40 \$36.96 A60 \$66.78

GALVANIZED (G-90)
Closed Sections Add \$129.78

1", 1-1/4", 1-1/2", 1-3/4" face available — no charge.

NOTE: Faces over 7", maximum rail length is 120"

CCW 16 maximum length 126"

M-14 CCW Flush Sticks-2" Face

CCW Flush Stick Prices



May, 2024

PER FOOT PRICING - "ESTIMATING"

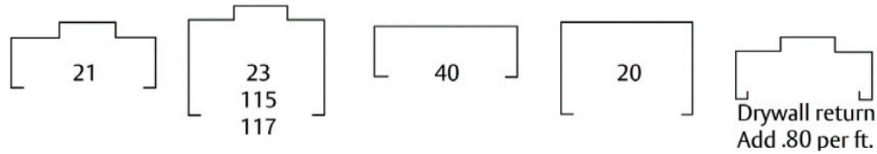

	CCW NO.	ITEM NAME	DIMENSION	M 5-3/4	3 THRU 6	6-1/8 THRU 7-7/8	8 THRU 9-7/8	10 THRU 11-7/8	12 THRU 14
				CRS	CRS	CRS	CRS	CRS	CRS
OPEN SECTION	21	Plain Rail		\$17.35	\$18.12	\$20.12	\$23.00	\$26.29	\$29.41
	23	Plain Rail	4" Face	\$20.71	\$21.47	\$23.47	\$26.35	\$29.65	\$32.76
	115	Plain Rail	6" Face	\$26.03	\$27.18	\$30.18	\$34.50	\$39.44	\$44.12
	117	Plain Rail	8" Face	\$26.03	\$27.18	\$30.18	\$34.50	\$39.44	\$44.12
	40	Cased Open		\$18.24	\$19.00	\$21.00	\$23.88	\$27.18	\$30.29
	20	Cased Open	4" Face	\$21.59	\$22.35	\$24.35	\$27.24	\$30.53	\$33.65

GALVANNEAL (A40 & A60) A40 A60
 Price per Foot Add \$1.76 \$3.18

GALVANIZED (G-90) Add \$6.18

	CCW NO.	ITEM NAME	DIMENSION		3 THRU 6	6-1/8 THRU 7-7/8	8 THRU 9-7/8	10 THRU 11-7/8	12 THRU 14
					CRS	CRS	CRS	CRS	CRS
MISCELLANEOUS	19	Cover Plate (Flat Corner)			\$15.04	\$16.70	\$19.09	\$21.82	\$24.41
	27	Filler Plate w/out Stop			\$19.93	\$21.93	\$25.07	\$28.66	\$32.06
	22	Filler Plate w/Stop			\$19.93	\$22.13	\$25.30	\$28.92	\$32.35
	29	Head Cap			\$24.46	\$27.16	\$31.05	\$35.50	\$39.71
	91	Channel Head Reinf.			\$24.46	\$27.16	\$31.05	\$35.50	\$39.71
	92	Full Width Head Reinf.			\$18.12	\$20.12	\$23.00	\$26.29	\$29.41
	28	Full Jamo Depth	4" Face		\$56.90	\$62.20	\$69.84	\$78.56	\$86.83
	139	Full Jamo Depth	6" Face		\$72.02	\$79.97	\$91.43	\$104.52	\$116.91
	140	Full Jamo Depth	8" Face						
	51	2-Way Corner	1-9/16" O.S.		\$63.41	\$70.41	\$80.50	\$92.03	\$102.94
	52	2-Way Corner	1-15/16" O.S.						
	53	3-Way Corner	1-9/16" O.S.		\$75.19	\$83.49	\$95.45	\$109.12	\$122.06
	54	3-Way Corner	1-15/16" O.S.						

GALVANNEAL (A40 & A60) A40 A60
 Open Sections Add \$1.76 \$3.18
 Closed Sections Add \$3.52 \$6.36

GALVANIZED (G-90)
 Open Sections Add \$6.18
 Closed Sections Add \$12.36

4-1/2" hinge or standard (E1, E2, E3, E4) strike preparations will be added to these stick prices for \$17.00 list per each preparation.

1", 1-1/4", 1-1/2", 1-3/4" face available — no charge.

M-14 CCW Flush Sticks - 2" Face

CCW Flush Stick Prices

May, 2024

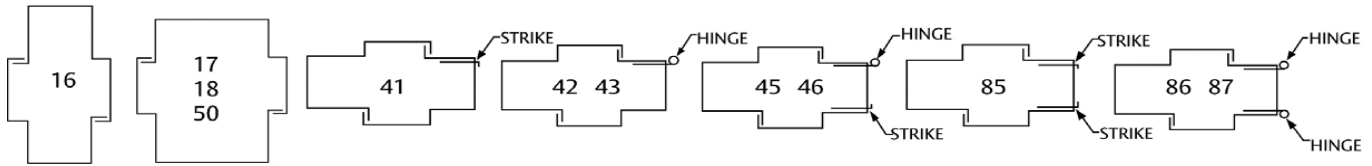

PER FOOT PRICING - "ESTIMATING"

CLOSED SECTION MULLION	CCW NO.	ITEM NAME	DIMENSION	3	6-1/8	8	10	12
				THRU 6	THRU 7-7/8	THRU 9-7/8	THRU 11-7/8	THRU 14
				CRS	CRS	CRS	CRS	CRS
	16	Plain		\$38.28	\$42.51	\$48.60	\$55.56	\$62.15
	17	Plain	4" Face	\$45.94	\$51.01	\$58.32	\$66.67	\$74.58
	18	Plain	6" Face	\$55.13	\$61.21	\$69.98	\$80.01	\$89.49
	50	Plain	8" Face	\$55.13	\$61.21	\$69.98	\$80.01	\$89.49

GALVANNEAL (A40 & A60)		<u>A40</u>	<u>A60</u>
Price per Foot	Add	\$3.52	\$6.36
GALVANIZED (G-90)		Add	\$12.36

4-1/2" hinge or standard (E1, E2, E3, E4) strike preparations will be added to these stick prices for \$17.00 list per each preparation.

1", 1-1/4", 1-1/2", 1-3/4" face available — no charge.

CCW 16 maximum length 126"

ESTIMATING COST PER INCH CCW ONLY

Multiply the cost per foot by the following conversion factor:

1"=.083	2"=.167	3"=.250	4"=.333	5"=.417	6"=.50	7"=.583	8"=.667	9"=.750	10"=.834	11"=.917
---------	---------	---------	---------	---------	--------	---------	---------	---------	----------	----------

M-12 CCW Flush Sticks 2" Face
10'6" Lengths
CCW Flush Stick Prices



May, 2024
 1/2" MINIMUM BACKBEND (INCLUDING 5-3/4)

CCW	ITEM NAME	DIMENSION	M 5-3/4	3 THRU 6	6-1/8 THRU 7-7/8	8 THRU 9-7/8	10 THRU 11-7/8	12 THRU 14	
			CRS	CRS	CRS	CRS	CRS	CRS	
OPEN SECTION	21	Plain Rail		\$334	\$345	\$368	\$397	\$430	\$465
	23	Plain Rail	4" Face	\$411	\$422	\$445	\$474	\$507	\$542
	115	Plain Rail	6" Face	\$501	\$517	\$551	\$595	\$645	\$698
	117	Plain Rail	8" Face	\$501	\$517	\$551	\$595	\$645	\$698
	40	Cased Open		\$385	\$396	\$419	\$448	\$481	\$516
	20	Cased Open	4" Face	\$421	\$431	\$454	\$483	\$516	\$552
	26	Strike Jamb	All	\$352	\$363	\$386	\$415	\$448	\$483
	24	Hinge Jamb	6'8"	\$388	\$399	\$422	\$451	\$484	\$519
	25	Hinge Jamb	7'0"						
	39	Hinge Jamb	7'2"						
	62	Hinge Jamb	7'10"	\$406	\$417	\$440	\$469	\$502	\$537
	63	Hinge Jamb	8'0"						
	119	Hinge Jamb	9'0"						
	120	Hinge Jamb	10'0"						

GALVANNEAL (A40 & A60) A40 A60
 Add \$18.48 \$33.39

GALVANIZED (G-90) Add \$64.89

CCW	ITEM NAME	DIMENSION	3 THRU 6	6-1/8 THRU 7-7/8	8 THRU 9-7/8	10 THRU 11-7/8	12 THRU 14	
			CRS	CRS	CRS	CRS	CRS	
MISCELLANEOUS	19	Cover Plate (Flat Corner)		\$286	\$305	\$329	\$357	\$386
	27	Filler Plate w/out Stop		\$389	\$415	\$448	\$486	\$526
	22	Filler Plate with Stop		\$389	\$415	\$448	\$486	\$526
	29	Head Cap		\$462	\$492	\$531	\$576	\$623
	91	Channel Head Reinf.		\$462	\$492	\$531	\$576	\$623
	92	Full Width Head Reinf.		\$345	\$368	\$397	\$430	\$465
	28	Full Jamb Depth	4" Face	\$1,055	\$1,112	\$1,184	\$1,268	\$1,356
	139	Full Jamb Depth	6" Face	\$1,292	\$1,378	\$1,487	\$1,612	\$1,744
	140	Full Jamb Depth	8" Face					
	51	2-Way Corner	1-9/16" O.S.	\$1,206	\$1,286	\$1,388	\$1,505	\$1,628
	52	2-Way Corner	1-15/16" O.S.					
	53	3-Way Corner	1-9/16" O.S.	\$1,465	\$1,562	\$1,685	\$1,827	\$1,977
	54	3-Way Corner	1-15/16" O.S.					

GALVANNEAL (A40 & A60) A40 A60
 Open Sections Add \$18.48 \$33.39
 Closed Sections Add \$36.96 \$66.78

GALVANIZED (G-90)
 Open Sections Add \$64.89
 Closed Sections Add \$129.78

1", 1-1/4", 1-1/2", 1-3/4" face available — no charge.

NOTE: Faces over 7", maximum rail length is 120"

**M-12 CCW Flush Sticks 2" Face
10'6" Lengths
CCW Flush Stick Prices**

May, 2024

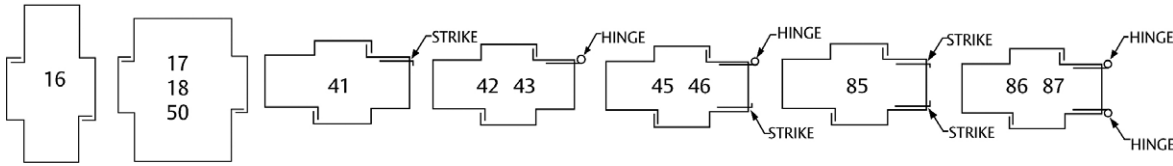

CCW NO.	MULLION TYPE	DIMENSION	3 THRU 6	6-1/8 THRU 7-7/8	8 THRU 9-7/8	10 THRU 11-7/8	12 THRU 14
			CRS	CRS	CRS	CRS	CRS
16	Plain		\$715	\$738	\$786	\$849	\$920
17	Plain	4" Face	\$858	\$885	\$944	\$1,018	\$1,104
18	Plain	6" Face	\$1,030	\$1,062	\$1,132	\$1,222	\$1,325
50	Plain	8" Face	\$1,030	\$1,062	\$1,132	\$1,222	\$1,325
41	Strike	All	\$733	\$756	\$804	\$867	\$938
42	Single Hinge	6'8"	\$769	\$792	\$840	\$903	\$974
43	Single Hinge	7'0"					
44	Single Hinge	7'2"					
81	Single Hinge	7'10"	\$787	\$810	\$858	\$921	\$992
82	Single Hinge	8'0"					
133	Single Hinge	9'0"					
134	Single Hinge	10'0"					
45	Hinge & Strike	6'8"	\$787	\$810	\$858	\$921	\$992
46	Hinge & Strike	7'0"					
47	Hinge & Strike	7'2"					
83	Hinge & Strike	7'10"	\$805	\$828	\$876	\$939	\$1,010
84	Hinge & Strike	8'0"					
135	Hinge & Strike	9'0"					
136	Hinge & Strike	10'0"					
85	Double Strike	All	\$751	\$774	\$822	\$885	\$956
86	Double Hinge	6'8"	\$823	\$846	\$894	\$957	\$1,028
87	Double Hinge	7'0"					
88	Double Hinge	7'2"					
89	Double Hinge	7'10"	\$859	\$882	\$930	\$993	\$1,064
90	Double Hinge	8'0"					
137	Double Hinge	9'0"					
138	Double Hinge	10'0"					

GALVANNEAL (A40 & A60)
Closed Sections Add A40 \$36.96 A60 \$66.78

GALVANIZED (G-90)
Closed Sections Add \$129.78

1", 1-1/4", 1-1/2", 1-3/4" face available — no charge.
NOTE: Faces over 7", maximum rail length is 120"
CCW 16 maximum length 126"

M-12 CCW Flush Sticks 2" Face

CCW Flush Stick Prices

May, 2024

1/2" MINIMUM BACKBEND (INCLUDING 5-3/4)

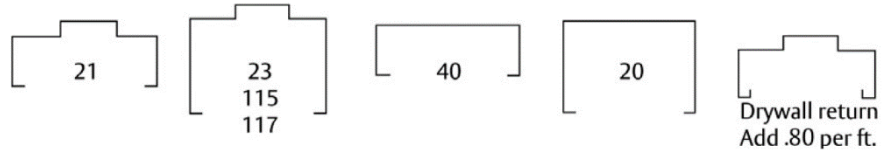

PER FOOT PRICING - "ESTIMATING"

CCW	ITEM NAME	DIMENSION	M 5-3/4	3 THRU 6	6-1/8 THRU 7-7/8	8 THRU 9-7/8	10 THRU 11-7/8	12 THRU 14
			CRS	CRS	CRS	CRS	CRS	CRS
OPEN SECTION	21	Plain Rail	\$31.82	\$32.82	\$35.00	\$37.76	\$40.94	\$44.29
	23	Plain Rail	\$39.18	\$40.18	\$42.35	\$45.12	\$48.29	\$51.65
	115	Plain Rail	\$47.74	\$49.24	\$52.50	\$56.65	\$61.41	\$66.44
	117	Plain Rail	\$47.74	\$49.24	\$52.50	\$56.65	\$61.41	\$66.44
	40	Cased Open	\$36.71	\$37.71	\$39.88	\$42.65	\$45.82	\$49.18
	20	Cased Open	\$40.06	\$41.06	\$43.24	\$46.00	\$49.18	\$52.53

GALVANNEAL (A40 & A60) A40 A60
 Price per Foot Add \$1.76 \$3.18

GALVANIZED (G-90) Add \$6.18

CCW	ITEM NAME	DIMENSION		3 THRU 6	6-1/8 THRU 7-7/8	8 THRU 9-7/8	10 THRU 11-7/8	12 THRU 14	
				CRS	CRS	CRS	CRS	CRS	
MISCELLANEOUS	19	Cover Plate (Flat Corner)		\$27.24	\$29.05	\$31.34	\$33.98	\$36.76	
	27	Filler Plate w/out Stop		\$37.09	\$39.55	\$42.67	\$46.26	\$50.05	
	22	Filler Plate with Stop		\$37.09	\$39.55	\$42.67	\$46.26	\$50.05	
	29	Head Cap		\$43.98	\$46.90	\$50.60	\$54.86	\$59.35	
	91	Channel Head Reinf.		\$43.98	\$46.90	\$50.60	\$54.86	\$59.35	
	92	Full Width Head Reinf.		\$32.82	\$35.00	\$37.76	\$40.94	\$44.29	
	28	Full Jamb Depth	4" Face		\$100.44	\$105.88	\$112.79	\$120.74	\$129.12
	139	Full Jamb Depth	6" Face		\$123.09	\$131.25	\$141.62	\$153.53	\$166.10
	140	Full Jamb Depth	8" Face		\$123.09	\$131.25	\$141.62	\$153.53	\$166.10
	51	2-Way Corner	1-9/16" O.S.		\$114.88	\$122.50	\$132.18	\$143.29	\$155.03
	52	2-Way Corner	1-15/16" O.S.		\$114.88	\$122.50	\$132.18	\$143.29	\$155.03
	53	3-Way Corner	1-9/16" O.S.		\$139.50	\$148.75	\$160.50	\$174.00	\$188.25
	54	3-Way Corner	1-15/16" O.S.		\$139.50	\$148.75	\$160.50	\$174.00	\$188.25

GALVANNEAL (A40 & A60) A40 A60
 Open Sections Add \$1.76 \$3.18
 Closed Sections Add \$3.52 \$6.36

GALVANIZED (G-90)
 Open Sections Add \$6.18
 Closed Sections Add \$12.36

4-1/2" hinge or standard (E1, E2, E3, E4) strike preparations will be added to these stick prices for \$17.00 list per each preparation.

1", 1-1/4", 1-1/2", 1-3/4" face available — no charge.

NOTE: Faces over 7", maximum rail length is 120"

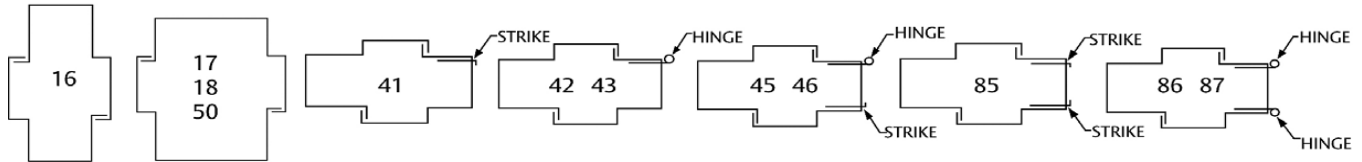

PER FOOT PRICING - "ESTIMATING"

	CCW NO.	MULLION TYPE	DIMENSION	3 THRU 6		6-1/8 THRU 7-7/8	8 THRU 9-7/8	10 THRU 11-7/8	12 THRU 14
				CRS	CRS	CRS	CRS	CRS	
				CRS	CRS	CRS	CRS	CRS	
CLOSED SECTION MULLION	16	Plain		\$68.10	\$70.24	\$74.90	\$80.82	\$87.61	
	17	Plain	4" Face	\$81.72	\$84.29	\$89.88	\$96.98	\$105.14	
	18	Plain	6" Face	\$98.07	\$101.15	\$107.86	\$116.38	\$126.16	
	50	Plain	8" Face	\$98.07	\$101.15	\$107.86	\$116.38	\$126.16	

GALVANNEAL (A40 & A60)		<u>A40</u>	<u>A60</u>
Price per Foot	Add	\$3.52	\$6.36
GALVANIZED (G-90)		Add	\$12.36

4-1/2" hinge or standard (E1, E2, E3, E4) strike preparations will be added to these stick prices for \$17.00 list per each preparation.

1", 1-1/4", 1-1/2", 1-3/4" face available — no charge.

NOTE: Faces over 7", maximum rail length is 120"

Estimating CCW Per Foot M-16 Ga. CCW Flush Stick Prices

May, 2024

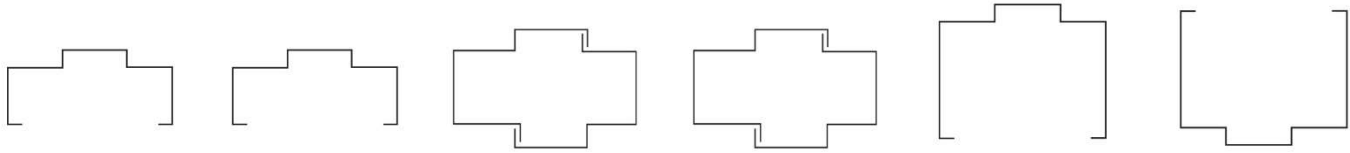

<p>.....</p> <p>.....</p> <p>.....</p> <p>.....</p> <p>.....</p> <p>.....</p> <p>.....</p> <p>.....</p> <p>.....</p> <p>.....</p>	<p>X</p> <p>X</p> <p>X</p> <p>X</p> <p>X</p> <p>X</p>	<p>=</p> <p>=</p> <p>=</p> <p>=</p> <p>=</p> <p>=</p>	<p>_____</p> <p>_____</p> <p>_____</p> <p>_____</p> <p>_____</p> <p>_____</p>
---	---	---	---

TOTAL

PRICE PER FOOT ESTIMATED

JAMB DEPTH	5-3/4	3 THRU 6	6-1/8 THRU 7-7/8	8 THRU 9-7/8	10 THRU 11-7/8	12 THRU 14
	CRS	CRS	CRS	CRS	CRS	CRS
Open Section 2" Face	\$13.35	\$14.06	\$16.24	\$19.00	\$22.18	\$25.53
Open Section 4" Face	\$16.71	\$17.41	\$19.59	\$22.35	\$25.53	\$28.88
Mullion 2" Face		\$31.60	\$36.50	\$42.71	\$49.85	\$57.39
Mullion 4" Face		\$38.87	\$44.89	\$52.54	\$61.32	\$70.59
Glass Stop 5/8 x 5/8		\$6.00				
Glass Stop 5/8 x 1		\$6.19				

GALVANNEAL (A40 & A60)		<u>A40</u>	<u>A60</u>
Open Sections	Add	\$1.76	\$3.18
Closed Sections	Add	\$3.52	\$6.36
GALVANIZED (G-90)			
Open Sections	Add		\$6.18
Closed Sections	Add		\$12.36

This per foot estimating formula includes foot clips and mullion stirrup anchors. All other anchor types are extra. Anchors must be ordered separately and will be invoiced accordingly. Other CCW component prices will work in this formula by using a per foot price of the published 10 foot, 6 inch price.

Single door opening (4-1/2" hinge)	1 1/2 pair hinge preparations and strike	Add	\$72
Double Door Opening (4-1/2" hinge)	2 pair hinge preparations and strike	Add	\$90
	3 pair hinge preparations	Add	\$108
	4 pair hinge preparations	Add	\$144
Additional hinge or strike preparations (Per Preparation)		Add	\$18
Saw miter (SMO) per cut		Add	\$17
Butt end notch (SBE) per notch		Add	\$17
Welded miter corner		Add	\$88
Welded butt end corner less than 3" face		Add	\$76
Welded butt end corner 3" face or larger		Add	\$108

ESTIMATING COST PER INCH CCW ONLY

Multiply the cost per foot by the following conversion factor:

1"=.083	2"=.167	3"=.250	4"=.333	5"=.417	6"=.50	7"=.583	8"=.667	9"=.750	10"=.834	11"=.917
---------	---------	---------	---------	---------	--------	---------	---------	---------	----------	----------

**Estimating CCW Per Foot M-14 Ga.
CCW Flush Stick Prices**

May, 2024

The diagram shows six different door profiles: two open section profiles (2" and 4" face), two mullion profiles (2" and 4" face), and two glass stop profiles (5/8 x 5/8 and 5/8 x 1). Below the diagrams is a grid of 6 rows and 6 columns of dots. To the right of the grid are six rows of calculation lines: $\underline{\hspace{1cm}} \times \underline{\hspace{1cm}} = \underline{\hspace{1cm}}$. A horizontal line at the bottom right is labeled **TOTAL**.

PRICE PER FOOT ESTIMATED

JAMB DEPTH	STEEL TYPE	5-3/4	3 THRU 6	6-1/8 THRU 7-7/8	8 THRU 9-7/8	10 THRU 11-7/8	12 THRU 14
		CRS	CRS	CRS	CRS	CRS	CRS
	Open Section 2" Face	\$17.35	\$18.12	\$20.12	\$23.00	\$26.29	\$29.41
	Open Section 4" Face	\$20.71	\$21.47	\$23.47	\$26.35	\$29.65	\$32.76
	Mullion 2" Face	\$38.28	\$38.28	\$42.51	\$48.60	\$55.56	\$62.15
	Mullion 4" Face	\$45.94	\$45.94	\$51.01	\$58.32	\$66.67	\$74.58
	Glass Stop 5/8 x 5/8		\$6.00				
	Glass Stop 5/8 x 1		\$6.19				

GALVANNEAL (A40 & A60)		<u>A40</u>	<u>A60</u>
Open Sections	Add	\$1.76	\$3.18
Closed Sections	Add	\$3.52	\$6.36
GALVANIZED (G-90)			
Open Sections	Add		\$6.18
Closed Sections	Add		\$12.36

This per foot estimating formula includes foot clips and mullion stirrup anchors. All other anchor types are extra. Anchors must be ordered separately and will be invoiced accordingly. Other CCW component prices will work in this formula by using a per foot price of the published 10 foot, 6 inch price.

Single door opening (4-1/2" hinge)	1 1/2 pair hinge preparations and strike	Add	\$72
Double Door Opening (4-1/2" hinge)	2 pair hinge preparations and strike	Add	\$90
Additional hinge or strike preparations (Per Preparation)	3 pair hinge preparations	Add	\$108
Saw miter (SMO) per cut	4 pair hinge preparations	Add	\$144
Butt end notch (SBE) per notch		Add	\$18
Welded miter corner		Add	\$17
Welded butt end corner less than 3" face		Add	\$17
Welded butt end corner 3" face or larger		Add	\$88
(Factory weld charges do not include the cut charges)		Add	\$76
		Add	\$108

ESTIMATING COST PER INCH CCW ONLY



Multiply the cost per foot by the following conversion factor:

1"=.083	2"=.167	3"=.250	4"=.333	5"=.417	6"=.50	7"=.583	8"=.667	9"=.750	10"=.834	11"=.917
---------	---------	---------	---------	---------	--------	---------	---------	---------	----------	----------

May, 2024

ITEM	CCW	DESCRIPTION	18 GAUGE	GALV.	STAINLESS STEEL 16 GA.	
	93	Glass Stop 10' 6"	5/8" Ht x 5/8" — Painted/Punched *	\$63	NA	
	97	Glass Stop 10' 6"	5/8" Ht x 5/8" — Painted/Not Punched	\$46	NA	
	101	Glass Stop 10' 6"	5/8" Ht x 5/8" — Unpainted/Not Punched	\$40	Contact Factory	
	105	Glass Stop 10' 6"	5/8" Ht x 5/8" — Unpainted/Punched *	\$46	Contact Factory	
	94	Glass Stop 10' 6"	5/8" Ht x 1" — Painted/Punched *	\$65	NA	
	98	Glass Stop 10' 6"	5/8" Ht x 1" — Painted/Not Punched	\$47	NA	
	102	Glass Stop 10' 6"	5/8" Ht x 1" — Unpainted/Not Punched	\$41	Contact Factory	
	106	Glass Stop 10' 6"	5/8" Ht x 1" — Unpainted/Punched *	\$47	Contact Factory	
ITEM	CCW	DESCRIPTION	16 GAUGE	GALV.	STAINLESS STEEL 16 GA.	
	95	Glass Stop 10' 6"	3/4" Ht x 5/8" — Painted/Punched *	\$66	NA	
	99	Glass Stop 10' 6"	3/4" Ht x 5/8" — Painted/Not Punched	\$48	NA	
	103	Glass Stop 10' 6"	3/4" Ht x 5/8" — Unpainted/Not Punched	\$42	Contact Factory	
	107	Glass Stop 10' 6"	3/4" Ht x 5/8" — Unpainted/Punched *	\$48	Contact Factory	
	96	Glass Stop 10' 6"	3/4" Ht x 1" — Painted/Punched *	\$68	NA	
	100	Glass Stop 10' 6"	3/4" Ht x 1" — Painted/Not Punched	\$49	NA	
	104	Glass Stop 10' 6"	3/4" Ht x 1" — Unpainted/Not Punched	\$43	Contact Factory	
	108	Glass Stop 10' 6"	3/4" Ht x 1" — Unpainted/Punched *	\$49	Contact Factory	
	111	Spreader Bar 10'6" (Shipping)	Unpainted /Not Punched - 16 Ga. 3/8" x 1"	\$37	Contact Factory	
	175 **	Glass Stop 10'6"	Painted/Punched *	5/8" x 1"	\$65	NA
				3/4" x 1"	\$68	NA
				1" x 1"	\$58	NA
	177	Glass Stop 10'6"	Painted/Punched *	5/8" x 1"	\$106	NA
				3/4" x 1"	\$108	NA
				1" x 1"	\$111	NA

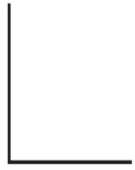
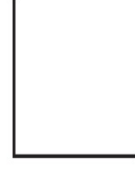
* Punched glass stop include #8 Tek self drilling and tapping screws.
 Hole punching on glass stop is standard 12 inch on center for oval head screw size #8.
 ** 10 ga. available for Bullet Resistant windows. Contact factory.

ITEM	CCW	DESCRIPTION	12 GAUGE	GALV.
	151	Glass Stop 10'6"	3/4" Ht x 3/4" 12 ga. – Painted/Punched *	\$129
	153	Glass Stop 10'6"	1" Ht. x 3/4" 12 ga. – Painted/Punched *	\$134
	155	Glass Stop 10'6"	1-1/4" Ht x 3/4" 12 ga.–Painted/Punched *	\$142
	201	Glass Stop 10'6"	5/8" H x 3/4" 12 ga. – Painted/Punched *	\$126

* Screw holes are 1/4" ovals punched 1-1/2" from each end and on 6" center lines for 1/4-28 UNF screws.

Note: 1/4-28 UNF screws are not provided with punched glass stops this page. Factory welded frames using these stops will have glass stops installed with Torx head screws.

1/4-28 x 3/4" Torx Self Drilling Security Screws are stock #MS004507 @ \$196.00 per 100 ea. 22 screws per 10'6" length required.

Glass stops set in place with spacing for glazing as specified on an elevation. Add \$14 per foot for installation. Customer must note which rabbet and the pocket size. 5/8" x 5/8" glass stop standard unless indicated otherwise.

Cut and Notch Descriptions

CCW Flush Stick Prices

May, 2024

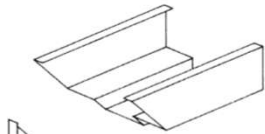

S.M.O.
(Saw Miter Only)
Per cut \$17.00

45° angle cut
2 cuts required per frame corner

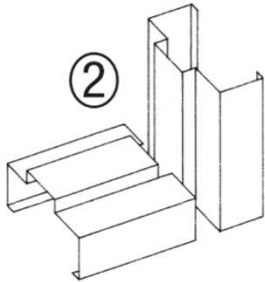
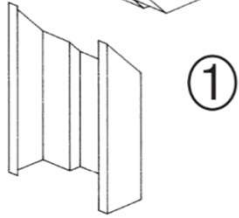

S.B.E.
(Saw Butt End)
Per joint \$17.00

Notch stop to butt adjoining member.
Used to join two jamb members with different face dimensions or profiles in the case of Double Egress.

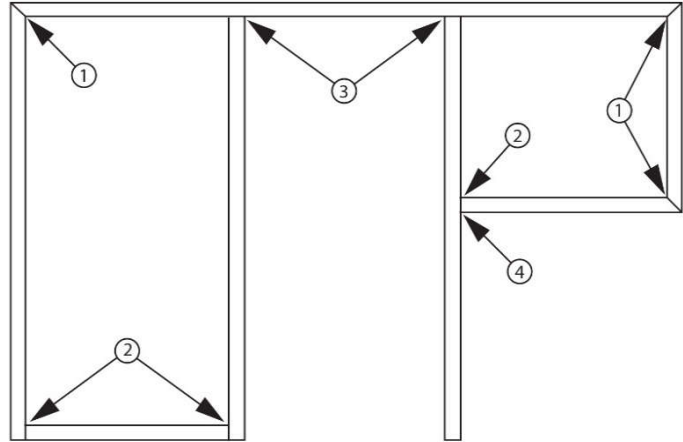

Typical elevation sample saw miter

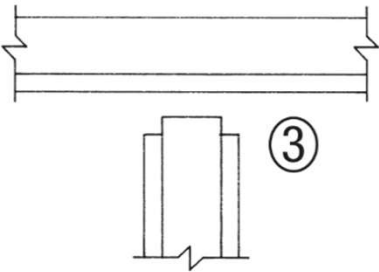

S.B.E.
(Saw Butt End)
Per joint \$17.00

Notch both stops on mullion to butt adjoining member.

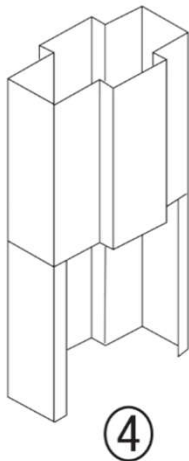

OPTION A
\$121

Full splice joint. Closed section to open section. Required when open section has drywall return.

Not Recommended

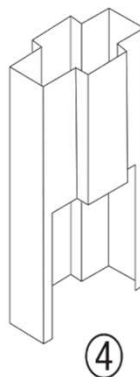

OPTION B
No Charge
Price vertical mullion full height. Cut and remove stop, leaving M-type return.

Recommended

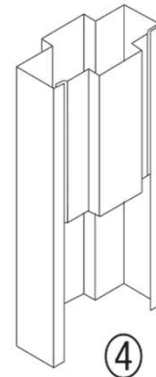

OPTION C
Price open section member and filler plate with stop. Required for some profiles.

See page 26 for details.

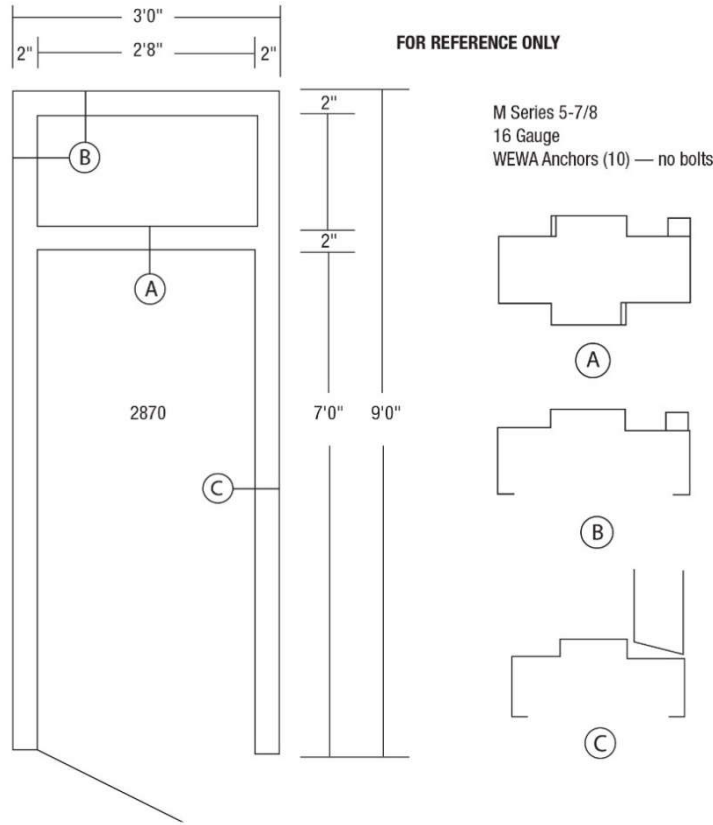

ESTIMATING COST PER INCH FACTORS — CCW ONLY

1" = .083	2" = .167	3" = .250	4" = .333	5" = .417	6" = .50	7" = .583	8" = .667	9" = .750	10" = .834	11" = .917
-----------	-----------	-----------	-----------	-----------	----------	-----------	-----------	-----------	------------	------------

CCW PRICING				
ITEM	SIZE (QTY)		COST	TOTAL
B and C	21'	x	\$14.06	= \$295.24
A	2'8" = 2.667	x	\$31.60	= \$84.29
Single Door	(3 hinges, 1 strike)		\$18.00	= \$72.00
Glass Stop	10'	x	\$6.00	= \$60.00
WEWA	10	x	\$9.00	= \$90.00
Saw Miter Cuts	(4)	x	\$17.00	= \$68.00
Saw Butt Cuts	(2)	x	\$17.00	= \$34.00
Frame Bundle Charge	(1)	x	\$6.00	= \$6.00
			TOTAL	\$709.52

KD PERIMETER				
ITEM	SIZE (QTY)		COST	TOTAL
B and C	3090 frame	x	\$338.00	= \$338.00
A	2'8" = 2.667	x	\$31.60	= \$84.29
Glass Stop	10'	x	\$6.00	= \$60.00
WEWA	(10)	x	\$9.00	= \$90.00
Saw Butt Cuts	(2)	x	\$17.00	= \$34.00
Frame Bundle Charge	(1)	x	\$6.00	= 6
			TOTAL	\$612.29

20
Pricing Examples of Factory Cut and Notch Frames
CCW Flush Stick Prices

May, 2024

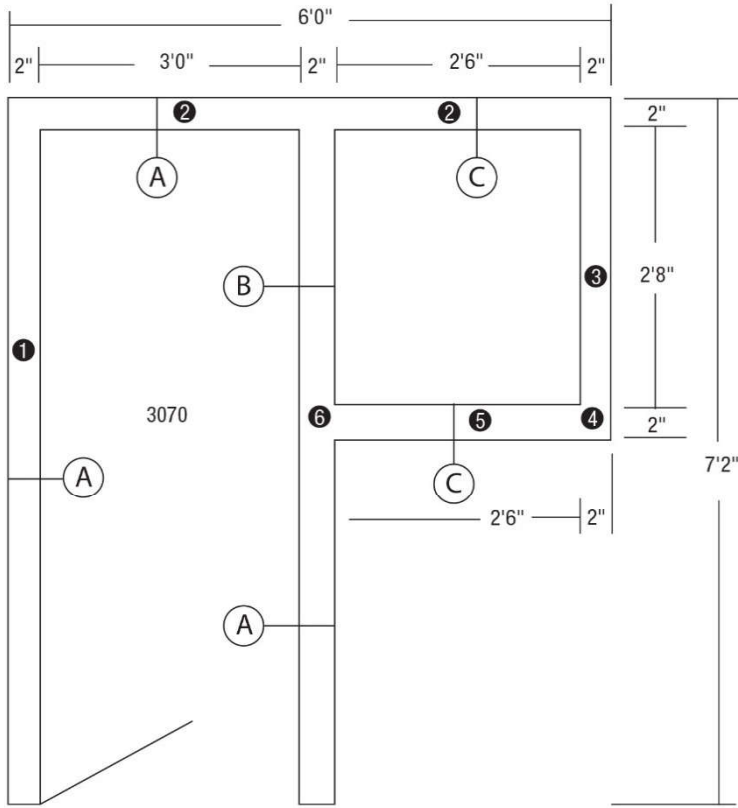

FOR REFERENCE ONLY

M Series 5-7/8
 16 Gauge
 MW Anchors

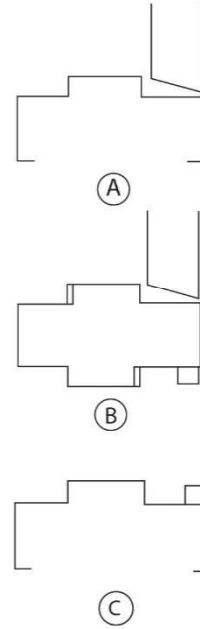

ESTIMATING COST PER INCH FACTORS — CCW ONLY

1" = .083	2" = .167	3" = .250	4" = .333	5" = .417	6" = .50	7" = .583	8" = .667	9" = .750	10" = .834	11" = .917
-----------	-----------	-----------	-----------	-----------	----------	-----------	-----------	-----------	------------	------------

CCW PRICING				
ITEM	SIZE (QTY)		COST	TOTAL
A and C	18'10"=18.834	x	\$14.06	= \$264.78
B mullion full height*	7'	x	\$31.60	= \$221.23
Single Door	(3 hinges, 1 strike)		\$18.00	= \$72.00
Glass Stop	10'	x	\$6.00	= \$60.00
MW anchors	(6)	x	\$3.00	= \$18.00
Saw Miter Cuts	(6)	x	\$17.00	= \$102.00
Saw Butt Cuts	(2)	x	\$17.00	= \$34.00
Frame Bundle Charge	(1)	x	\$6.00	= \$6.00
			TOTAL	\$778.01

KD PERIMETER				
ITEM	SIZE (QTY)		COST	TOTAL
① Hinge jamb	7'(1)	x	\$103.00	= \$103.00
② Head	5'8" (1)	x	\$101.00	= \$101.00
③ CCW 21	3'	x	\$14.06	= \$42.18
④ Jamb mitre	2	x	\$17.00	= \$34.00
⑤ Head	2'6" (1)	x	\$47.00	= \$47.00
⑥ Stop notch	(2)	x	\$17.00	= \$34.00
B mullion full height	7'	x	\$36.50	= \$255.48
Strike in mullion	(1)	x	\$17.00	= \$17.00
Glass stop	10'	x	\$6.00	= \$60.00
MW anchors	(6)	x	\$3.00	= \$18.00
Frame bundle charge	(1)	x	\$6.00	= \$6.00
			TOTAL	\$717.66

* Mullion is priced full height and bottom half stop is cut out; not charge to wrap wall.

**Pricing Examples of Factory Cut and Notch Frames
CCW Flush Stick Prices**

May, 2024

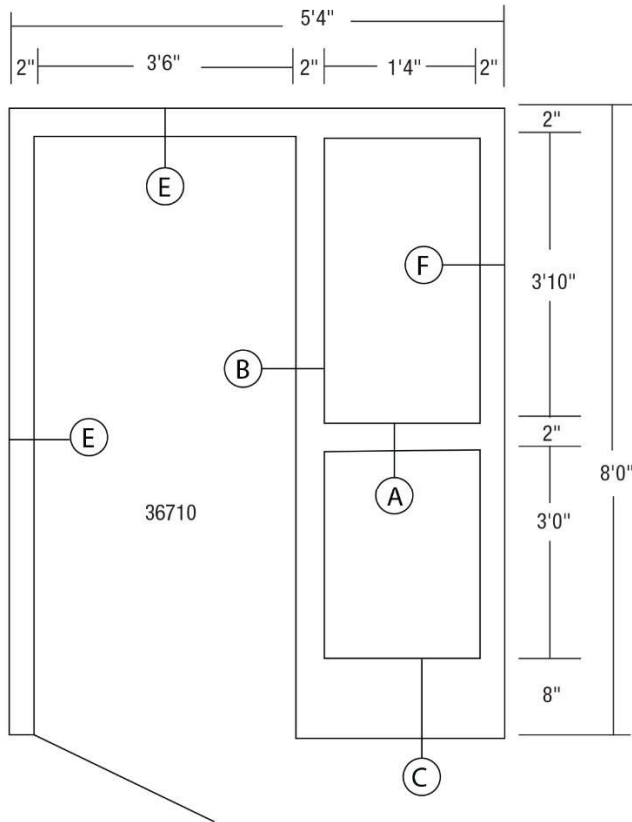

FOR REFERENCE ONLY

M Series 6 3/4
16 Gauge
WWS Anchors

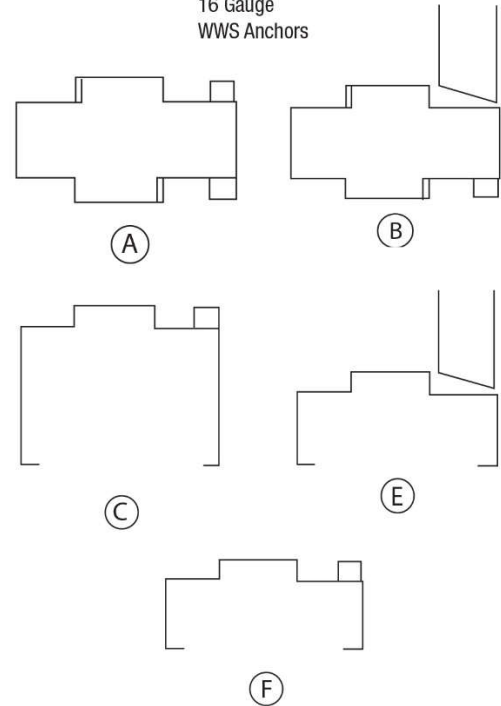

ESTIMATING COST PER INCH FACTORS — CCW ONLY

1" = .083	2" = .167	3" = .250	4" = .333	5" = .417	6" = .50	7" = .583	8" = .667	9" = .750	10" = .834	11" = .917
-----------	-----------	-----------	-----------	-----------	----------	-----------	-----------	-----------	------------	------------

CCW PRICING				
ITEM	SIZE (QTY)		COST	TOTAL
E and F	21'4"=21.33	x	\$16.24	= \$346.30
A and B	9'2"=9.167	x	\$36.50	= \$334.57
C	1'4"=1.33	x	\$24.35	= \$32.39
Single Door	(4 hinges, 1 strike)		\$18.00	= \$90.00
Glass Stop	19'	x	\$6.00	= \$114.00
WWS anchors	(8)	x	\$7.00	= \$56.00
Saw Miter Cuts	(4)	x	\$17.00	= \$68.00
Saw Butt Cuts	(5)	x	\$17.00	= \$85.00
Frame Bundle Charge	(1)	x	\$6.00	= \$6.00
			TOTAL	\$1,132.26

KD PERIMETER				
ITEM	SIZE (QTY)		COST	TOTAL
E and F	5080 Frame	x	\$428.00	= \$428.00
A and B	9'2"=9.167	x	\$36.50	= \$334.57
C	1'4"=1.33	x	\$24.35	= \$32.39
Glass Stop	19'	x	\$6.00	= \$114.00
WWS Anchors	(8)	x	\$7.00	= \$56.00
Saw Butt Cuts	(5)	x	\$17.00	= \$85.00
Frame Bundle Charge	(1)	x	\$6.00	= \$6.00
			TOTAL	\$1,055.96

Note: E and F consist of HJ, BJ and head price.

22
Pricing Examples of Factory Cut and Notch Frames
CCW Flush Stick Prices

May, 2024

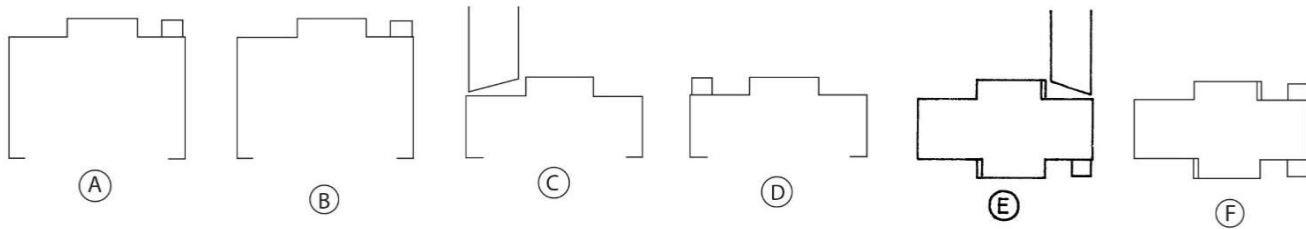
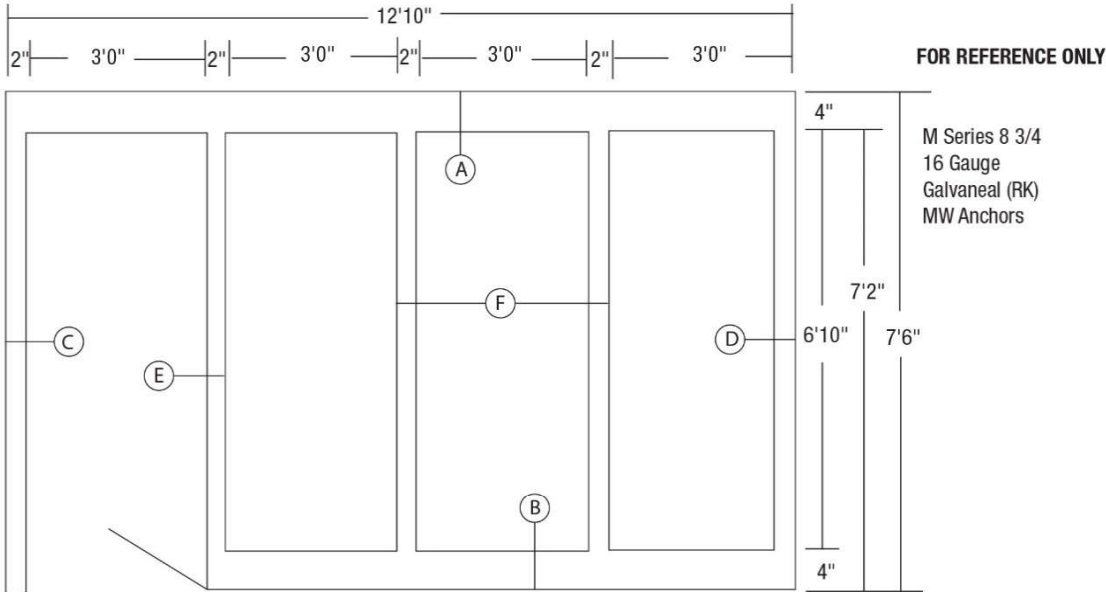

ESTIMATING COST PER INCH FACTORS — CCW ONLY

1" = .083	2" = .167	3" = .250	4" = .333	5" = .417	6" = .50	7" = .583	8" = .667	9" = .750	10" = .834	11" = .917
-----------	-----------	-----------	-----------	-----------	----------	-----------	-----------	-----------	------------	------------

CCW PRICING				
ITEM	SIZE (QTY)		COST	TOTAL
C and D	15'	x	\$19.00	= \$285.00
A and B	21'10"=21.834	x	\$22.35	= \$488.05
E and F	20'10"=20.834		\$49.07	= \$1,022.37
Single Door	(3 hinges, 1 strike)	x	\$18.00	= \$72.00
Glass Stop	59'	x	\$6.00	= \$354.00
MW Anchors Extra	6'	x	\$3.00	= \$18.00
Saw Butt Cuts	(9)	x	\$17.00	= \$153.00
Frame Bundle Charge	(1)	x	\$6.00	= \$6.00
			TOTAL	\$2,398.42

KD PERIMETER				
ITEM	SIZE (QTY)		COST	TOTAL
C and D	7'2" Strike Jamb (2)	x	\$150.00	= \$300.00
A	10', 4" Face Head (1)	x	\$281.00	= \$281.00
	3', 4" Face Head (1)	x	\$137.00	= \$137.00
B	9'4"=9.33	x	\$22.35	= \$208.55
E and F	20'10"=20.834	x	\$49.07	= \$1,022.37
Single Door	(3 hinges)	x	\$17.00	= \$51.00
Glass stop	59'	x	\$6.00	= \$354.00
MW Anchors	(6)	x	\$3.00	= \$18.00
Saw Butt Cuts	(7)	x	\$17.00	= \$119.00
Frame bundle charge	(1)	x	\$6.00	= \$6.00
			TOTAL	\$2,496.92

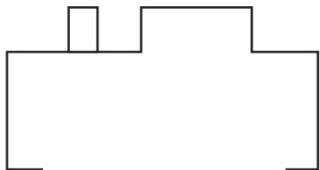
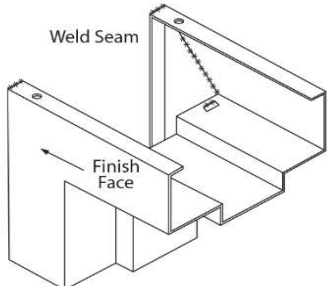
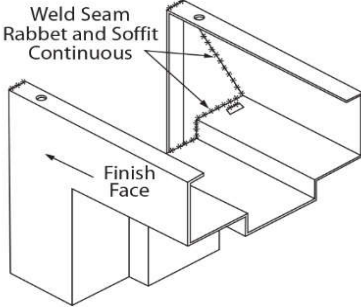
DESCRIPTION	CODE	PRICE		
<p>NOTE: Weld prices include shipping spreader bars welded in place.</p> <p>Glass stops will be attached to window elevations cut to length and pushed tight to the 1-15/16" rabbet with one screw when indicated on the elevation. Price glass stop separately, this installation is no charge. Additional screws are furnished separately. 5/8 x 5/8 glass stop standard unless indicated otherwise.</p> <p>Glass stops "set" in place with spacing for glazing as specified on frame elevation for an additional \$14.00 list per foot installed when indicated on each elevation ordered. Customer must note which rabbet and pocket size. 5/8 x 5/8 glass stop standard unless indicated otherwise.</p> <p>Frames will be manufactured standard unequal rabbet unless complete section details accompany each elevation.</p> <p>Indicate weld code per joint on all welded frame elevations.</p> <p>Continuous welds are not water tight. Exterior windows must be properly glazed with joints sealed at installation by the glazing contractor.</p> <p>CURRIES' reserves the option to face weld or back weld seams and finish face imperfections. Face welds over 4" will be intermittent welded to prevent distortion.</p> <p>Stainless Steel frames are not available in all welded corner configurations. Please consult the factory on stainless steel welded frame corners.</p>				
	Seam Weld Die Miter (KD)	SW	PER CORNER (Factory Weld Discount)	\$43
	Full Weld Die Miter (KD)	FW	PER CORNER (Factory Weld Discount)	\$77

Welded Assemblies
CCW Flush Stick Prices

May, 2024

	DESCRIPTION	CODE	PRICE
	Saw Miter - Continuous Weld + 2 S.M.O. Cuts @	SMW	PER CORNER (Factory Weld Discount) + (Factory Material Discount) \$88 \$34
	Saw miter - Continuous Weld 2" face jamb to 4" face head + 2 S.M.O. Cuts @	SMW	PER CORNER (Factory Weld Discount) + (Factory Material Discount) \$88 \$34
	Saw Miter - Weld Seam Tackweld Rabbet & Soffit + 2 S.M.O. Cuts @	SMT	PER CORNER (Factory Weld Discount) + (Factory Material Discount) \$76 \$34
	Saw Miter - Weld Seam Tackweld Rabbet & Soffit 2" face jamb to 4" face head + 2 S.M.O. Cuts @	SMT	PER CORNER (Factory Weld Discount) + (Factory Material Discount) \$76 \$34
	Saw Butt End - Weld Seam Rabbet & Soffit Continuous Less than or equal to 3" face + 1 Stop Notch @	BEW	PER CORNER (Factory Weld Discount) + (Factory Material Discount) \$108 \$17
	Saw Butt End - Weld Seam Tackweld Rabbet & Soffit Less than or equal to 3" face + 1 Stop Notch @	BET	PER CORNER (Factory Weld Discount) + (Factory Material Discount) \$76 \$17

	DESCRIPTION	CODE		PRICE
	Saw Butt - Weld Seam Rabbet & Soffit Continuous Greater than 3" face + 1 Stop Notch @	SBW	PER CORNER (Factory Weld Discount) + (Factory Material Discount)	\$123 \$17
	Saw Butt End - Weld Seam Tackweld Rabbet & Soffit Greater than 3" face + 1 Stop Notch @	SBT	PER CORNER (Factory Weld Discount) + (Factory Material Discount)	\$99 \$17
	Butt End - Face Weld Seam + 1 Stop Notch @	BEF	PER CORNER (Factory Weld Discount) + (Factory Material Discount)	\$108 \$17
	Field Splice - Weld Attaching Bracket - Notch to fit + 1 Stop Notch @	FSP	PER SPLICE (Factory Weld Discount) + (Factory Material Discount)	\$118 \$17
	Weld Cap on Jamb and Finish	P115	PER CAP	\$137
	Weld Splice - Continuous Weld	WSP	PER SPLICE (Factory Weld Discount)	\$125
	Double Egress Head Splice Weld	REVERSE WLD	PER HEAD (Factory Material Discount)	\$139

Closed Profile Seam Pricing

CCW Flush Stick Prices

May, 2024

Certain custom mullion (closed) profiles require seam breaks during the manufacturing process on the face or rabbet. These seams will be filled at the factory before shipment at a cost of \$8.00/foot per seam. Examples of profiles that will require this additional charge are listed below. This is not an inclusive list, but a representative sample.

Examples given are for 14 & 16 gauge material.

Closed Mullion - All sizes require two seams. The charge is \$8.00/foot per seam or \$16.00/foot. Both seams.

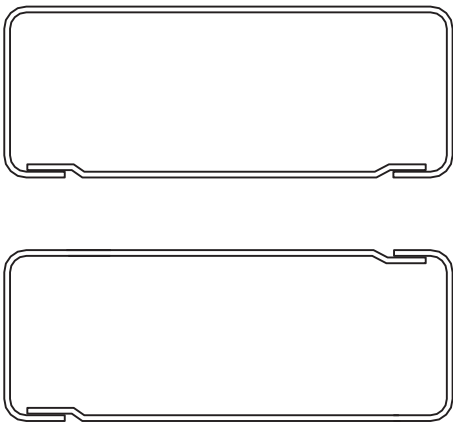

Single Rabbet Mullion - If the face (F1) is less than 1" or greater than 2" or the rabbet (D1 or D2) is less than 5/8" or greater than 6", this profile will require one seam at \$8.00/foot.

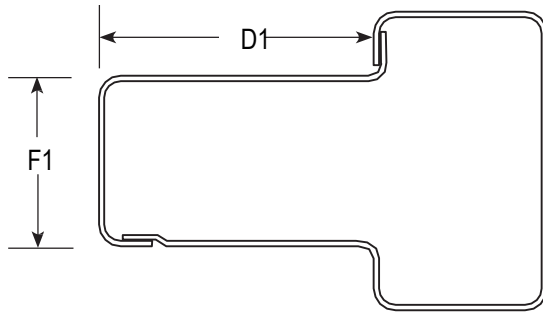

Single Rabbet / Cased Mullion - All sizes require one seam. The charge is \$8.00/foot.

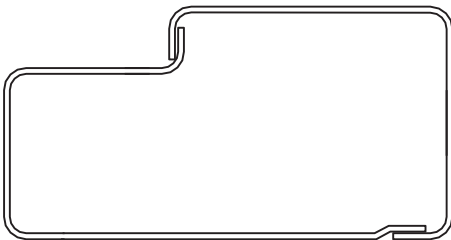

Double Rabbet Mullion - If the face (F1) is any dimension other than 2" or the rabbet (R1 or R2) is less than 2", this profile will require one seam at \$8.00/foot.

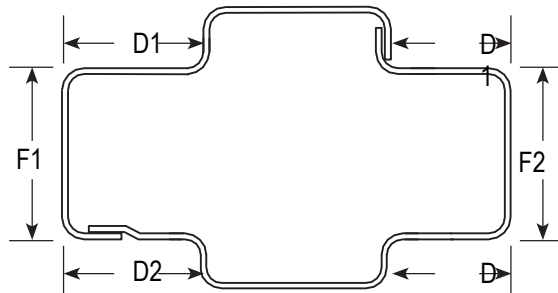

Double Rabbet / Cased Mullion - All sizes require one seam. The charge is \$8.00/foot.

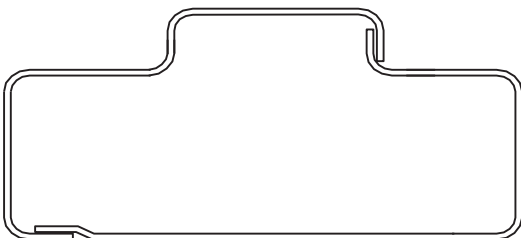

GENERAL GUIDELINES

CURRIES Quick Ship Program is designed to fulfill your customers' needs as quickly as possible.

All orders that qualify for this program are subject to applicable Quick Ship pricing structures as set forth on your current discount schedule.

The Quick Ship lead time starts on the next business day after the order is received. If engineering drawings are required to be made at CURRIES the lead time will be extended. If a Quick Ship order is requested to be Pool Shipped or shipped with other goods the lead time is extended accordingly. Additional 5 to 15 day lead time of order writing requests

Order must have all questions answered and all elevation drawings completed, if required, prior to being entered into production

Quantity Limitations

Priority A	Priority B	Priority C
50 frames and/or 40 doors, maximum 150 pieces	100 frames and/or 75 doors, maximum 300 pieces	200 frames and/or 100 doors, maximum 600 pieces
Maximum 50 welded frames	Maximum 100 welded frames	Maximum 200 welded frames

Door Limitations

Limited to 12 of each

- Concealed hardware
- Floor closers
- Flush window moulding
- Pivots
- Prefinish (add 2 weeks)

Frame Limitations

Limited to 24 of each

- Concealed hardware
- Currieseal (Priority C only)
- 3 Sided Mercury thermal break (Priority C only)
- Hospital stops
- Pivots
- Rescue hardware

Frame Limitations

Limited to 50 of each

- Hurricane rated greater than 70 psf (Priority B and C only)

EXCLUSIONS FROM PRIORITY PROGRAMS

12 gauge frames	G90 galv	Rabbetted doors	<u>Specialty Products:</u>	
Arch Top radius frames	Hemmed Frames	Radius doors and windows	Acoustical	Hurricane (Doors only)
Behavioral health	Jamb locks	Special profiles	Attack Resistant	Lead-Lined
Bifold doors	Low profile exit devices	Stile and Rail doors	Blast Resistant	RF Shielding
Bituminous coating	Mercury Thermal Break Frames	Thickness other than 1-3/4"	Bullet Resistant	Stainless Steel
CURRIStain Doors	Mortise auto door bottom	777 Trio doors	Flood Resistant	Tornado Resistant
Doors over 4'0" x 9'0"	Panels w/strikes	777E Trio-E doors	Forced Entry Bullet Resistant Water Resistant	
Embossed Panel Doors	Pocket pivots	Wicket doors		
Factory installed glass	Prefinish Welded Frames	Zinc Rich Primer		

Check Factory for Availability:

2P Doors

PACKAGING - Doors

No Extra Door Charge — Included in Door Price

All doors will be either crated or palletized (with additional protection) based upon door sizes and/or quantity

ORDERING

1. Use the standard order form
2. Mark on the order form "Quick Ship"

PACKAGING - Frames

1. Cardboard Wrap — No Charge. One (1) to three (3) pieces. This wrap designed for U.P.S. shipment or with other goods shipments.
2. Cardboard Box (double walled) 8" x 12" — No Charge. One or two boxes per order holding three (3) to nine (9) pieces per box.
3. Pallets — No Charge. Larger orders will be palletized.
4. Wood Crating — Must be specified by your company. The costs for crating frame pieces are listed below. Contact the factory or Service Center for the cost of crating welded frames.

Frame crating charges for frame pieces with 1 to 3 pieces in the same crate:

- A. 3" thru 7 3/4" jamb depth \$20.00 net per frame
- B. Over 7 3/4" thru 14" jamb depth \$23.00 net per frame

FREIGHT

1. All material is F.O.B., Mason City, IA.
2. Quick Ship Doors or Frames may be held to ship with other goods.

DESCRIPTION	PAGE
Closers	2
Co-ordinating Device	2
Door Bottom	2
Dummy Trim	2
Exit Alarm (surface mounted)	3
Flush Bolts	4
Flush Pull, Mortise	4
Floor Closers	3
Floor Closers (Door Bevel Add)	3
Hinges	4-6
Holdings	7
Interviewers	7
Light Switch	7
Locks	7-10
Locks (Deadlocks)	10
Magnetic Switch and Locks	10
Mail Slot	10
Panic Exit Devices	11
Pivots	12
Power Transfer	12
Push and Pull Reinforcement	12
Push Pull Bar Reinforcement	12
Removable Mullion Prep	12
Rescue Hardware	13
Roller Latch	13
Robe Hook Reinforcement	13
Sliding Door (Pocket) Hardware Reinforcement	13
Strikes	13-14
Surface Bolts	14

Non-Standard or Special Special Hardware Preps

May, 2024

DOOR CODE NO.	DOOR LIST PRICE ADD	FRAME CODE NO.	FRAME LIST PRICE ADD
---------------	---------------------	----------------	----------------------

CLOSERS						
	Concealed closer in frame track in door (e.g., Sargent 260)		CC**	\$313	CC**	\$251
	Concealed — closer in frame, surface on door (e.g., Sargent 270)		CL	\$36	CC**	\$251
	Semi concealed — closer in frame concealed mounting in door (e.g., LCN 330)		CC**	\$313	CC**	\$251
	Surface mounted	14 ga.	CL	\$36	E10	\$30
		12 ga.	C2	\$43		
	Regular arm	12 ga.			E10	\$38
		10 ga.			E10	\$44
		7 ga.			E10	\$66
	Parallel arm or surface holder	14 ga.			E11	\$30
		12 ga.			E11	\$38
		10 ga.			E11	\$44
		7 ga.			E11	\$66
	Top jamb mounted				E12	\$30
	Corner bracket		14 ga.		E13	\$47
	Combination: Closer/Holder/Detector				E15	\$47
Electric access hole for above				*	\$31	
Double Parallel Arm		14 ga.		E16	\$50	
Full sleeve reinforcement		14 ga.		E17	\$46	
Half sleeve reinforcement		14 ga.		E18	\$38	

CO-ORDINATING DEVICE (SURFACE MOUNTED) ADVISE TYPE						
	1. Face mounted type (e.g., lves 469)				G24	\$30
	2. Soffit mounted type (e.g., lves 900)				G23	\$47

DOOR BOTTOM						
	1. Mortise type (e.g., Pemko 411A)		DB**	\$198		
	2. Semi mortise (e.g., Pemko 4131)		DB**	\$198		
	3. Special depth bottom channel		DB**	\$117		

DUMMY TRIM						
1. Std G2 or G3 prep & reinforcing			DTA	N/C		
2. Non std. G2 or G3 prep & reinforcing			DT	\$73		

****MAKE NOTE OF HARDWARE MANUFACTURER AND HARDWARE NUMBERS. SUPPLY TEMPLATE INFORMATION WHEN ORDERING**

**Non-Standard or Special
Special Hardware Preps**

May, 2024

DOOR CODE NO.	DOOR LIST PRICE ADD	FRAME CODE NO.	FRAME LIST PRICE ADD
---------------	---------------------	----------------	----------------------

EXIT ALARM (SURFACE MOUNTED) ADVISE TYPE (E.G. SARGENT 5100/5800 SERIES)

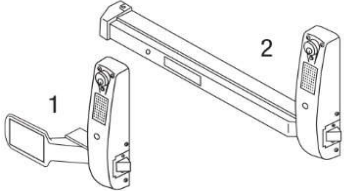
	1. No face prep door, reinforce frame (Rim Strike)	EXAL	\$46	E8	\$30
	2. Function prep door, reinforce frame (Rim Strike)	G11**	\$46	E8	\$30
	3. Label fire pin if required (Check template)		\$30		

FLOOR CLOSERS - ADD SPECIAL BEVEL CHARGES PER HARDWARE TEMPLATE

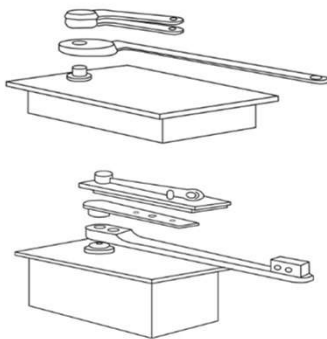
	Single acting (ANSI A 115.9)* (e.g., Rixson 20-25 type) (top and bottom prep)	CF**	\$562	CF**	\$145
	Non ANSI type single acting* (top and bottom prep)	CF**	\$562	CF**	\$145
	Double acting (ANSI A 115.7 or.8)* (e.g., Rixson - 10, 15, 30 type) (top and bottom prep)	CF**	\$562	CF**	\$145
	Non ANSI type double acting* (top and bottom prep)	CF**	\$562	CF**	\$145

SPECIAL BEVELS

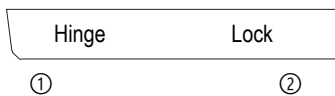
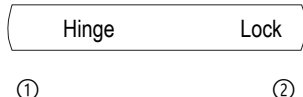
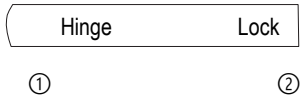
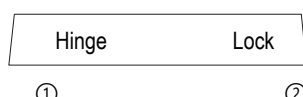
	<p>"D" Bevel</p> <p>① 1/8" in 2"</p> <p>② 1/8" in 2"</p> <p>1/8" in 2" bevel hinge and lock rail, 1/4" radius low side hinge edge only (required for some pivot hardware)</p>	"D" Bevel *	\$454		
	<p>"E" Bevel -</p> <p>① 2 5/8" radius</p> <p>② 2 5/8" radius</p> <p>Bull Nose both Edges</p>	"E" Bevel *	\$736		
	<p>"F" Bevel</p> <p>① 2 5/8" radius</p> <p>② Square</p> <p>Bull Nose one Edge</p>	"F" Bevel *	\$368		
	<p>"G" Bevel</p> <p>① 1/8" in 2"</p> <p>② 1/8" in 2"</p>	"G" Bevel *	\$18		
			* ADD PER DOOR		

CONTINUED ON NEXT PAGE

FLOOR CLOSER ALERT

*THE USE OF INTERMEDIATE PIVOTS WITH FLOOR CLOSERS IS EXTRA. PRICE PIVOTS SEPARATELY FROM PIVOT SECTION. ALSO, MOST FLOOR CLOSERS REQUIRE A SPECIAL BEVEL OR RADIUS DOOR EDGE, WHICH IS NOT INCLUDED IN THESE PRICES. DOOR BEVEL PRICES FOLLOW.

**MAKE NOTE OF HARDWARE MANUFACTURER AND HARDWARE NUMBERS. SUPPLY TEMPLATE INFORMATION WHEN ORDERING

Non-Standard or Special Special Hardware Preps

May, 2024

		DOOR CODE NO.	DOOR LIST PRICE ADD	FRAME CODE NO.	FRAME LIST PRICE ADD	
FLUSH BOLTS						
	Standard ANSI 115.4 manual or automatic (e.g., lves 458-559)	Per Pair	H1HO H1	NC \$87	H2 \$53	
	Special self latching with/lip strike ANSI 115.4	Per Pair	H1	\$87	FBS \$68	
	Non-ANSI manual or automatic (e.g., lves 457)	Per Pair	FB**	\$394	FB** \$129	
	Required for some automatic, reinforce only- (frame no hole)				H1 \$30	
	Reversible frame flush bolt strike (includes strike plate installed)				H5 \$53	
	Reversible door (panel) flush bolt strike		H5	\$63		
FLUSH PULL, MORTISE						
	One side (14 ga. reinf.) (7 ga. reinf.)		FP** FP**	\$101 \$124		
	Two sides (14 ga. reinf.) (7 ga. reinf.)		FP** FP**	\$117 \$144		
	Edge pull		**	\$92		
	NOTE: Some pulls will not fit back to back (1 3/4" door), prep must be offset on door, use one side price for each pull.					
HINGES						
	1-3/4" door 4" x 4".130 standard weight	Per Hinge	403	\$24	403 \$18*	
	4 1/2" x 4 1/2".134 standard weight or.180 heavy weight: Up to 7'6" standard	1 3/4" door	453 + 454	No Charge	453 + 454 \$18*	
		Per Hinge	H453 + H454	No Charge	H453 + H454 \$18*	
		Per Hinge	U453 + U454	No Charge	U453 + U454 \$18*	
	5" x 4 1/2" standard or heavy weight: 1 3/4 door (cam lift also)	Per Hinge		\$9		\$18*
	Hinge requiring 1/4" 20 tap per hole			\$9		\$9
	Double mortise hinge, standard or heavy weight hinge in the door edge	Per Hinge	SDM HDM	\$19 \$19		
	Over mortise hinge in door, heavy weight hinge	Per Hinge	HOM	\$21		
6" Hinges	Per Hinge	HG	\$122	HG	\$122	
Non-standard size/non-template	Per Hinge	HG	\$168	HG	\$168	
Radius corner hinge preparation			Not Available		Not Available	

*No charge for KD frame, add applies to stick material

Continued on next page

****MAKE NOTE OF HARDWARE MANUFACTURER AND HARDWARE NUMBERS. SUPPLY TEMPLATE INFORMATION WHEN ORDERING**

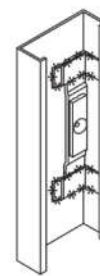
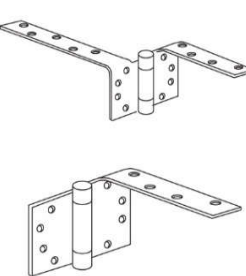
		DOOR CODE NO.	DOOR LIST PRICE ADD	FRAME CODE NO.	FRAME LIST PRICE ADD
HINGES (CONTINUED)					
	Full surface mounted continuous hinge (reinforcement only)				
	Edge mounted door (e.g., McKinney 12, 14, 25) Face mounted door (e.g., McKinney 58 Series) Frame reinforced Rabbet Mount Face Mount	G19 HGC	N/C \$108	HGCR HGCF	\$80 \$80
	Full jamb width hinge reinforcing				
	7 gauge x 10" high	Per Hinge		FW	\$44
	3" - 8 7/8" jamb width	Per Hinge		FW	\$71
	9" - 20" jamb width				
	3/8" x 10" high	Per Hinge		FW	\$99
	3" - 8 7/8" jamb width	Per Hinge		FW	\$134
	9" - 20" jamb width	Per Hole			\$9
1/4" X 20 drill and tap per hole					
	High frequency frame hinge reinforcement strap support across face, rabbet and stop	Per Hinge		HFG	\$27
	3/16" flat plate reinforcement - full height of door (inside door hinge channel)	Per Foot	\$39		
	3/16" angle iron frame hinge face and rabbet reinforcement	Per Foot Full Height			\$46
	12 gauge "Eliason" (Easy Swing) (full jamb width frame reinforcing 12 gauge at mounting location)	Frrame Add Per Door		HGD	\$88
	Anchor hinge set (see note below) (includes intermediate 5" hinges) Prep 5" - No drill, no tap	Per Set	HGA** \$204		
	drill & tap (e.g. McKinney, TA 792)		HGA** \$419	HGA**	FACTORY WELDED FRAME \$419 LOOSE PARTS \$297
	(e.g., McKinney TA 793)		No Charge	HGA**	WELDED \$419 LOOSE PARTS \$297

CONTINUED ON NEXT PAGE



ANCHOR HINGE ALERT

NOTE: FACTORY WELDED FRAMES RECEIVE PREP FULLY REINFORCED WHEN PHYSICAL SAMPLES ARE PROVIDED (DRILLED AND TAPPED). ALL KD OR CUT AND NOTCH FRAMES ARE FULLY MORTISED, REINFORCEMENTS ARE SHIPPED LOOSE AND BLANK. DOORS ARE FULLY REINFORCED. DOORS ARE DRILLED AND TAPPED ONLY WHEN PHYSICAL SAMPLE PROVIDED.

****MAKE NOTE OF HARDWARE MANUFACTURER AND HARDWARE NUMBERS. SUPPLY TEMPLATE INFORMATION WHEN ORDERING**

Non-Standard or Special Special Hardware Preps

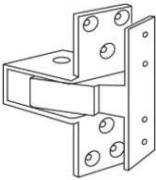
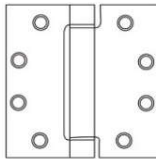
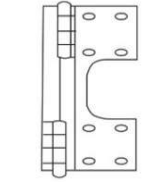
May, 2024

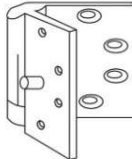

		DOOR CODE NO.	DOOR LIST PRICE ADD	FRAME CODE NO.	FRAME LIST PRICE ADD
HINGES (CONTINUED)					
	Pocket pivots (Pocket Hinge) (e.g., McKinney PH-3) NOTE: Most pocket hinges require a frame face larger than 2"; therefore, this preparation is not available on KD frames.	Per Hinge	PTP** \$211	PTP**	\$182
	Spring type hinges/Single Acting (e.g., McKinney # 1502)				
	4 1/2" templated standard or heavy weight	Per Hinge	U453 No Charge	U453	\$18*
	5" templated standard or heavy weight	Per Hinge	503 \$9 H503 \$9	503 H503	\$18 \$18
	Non-standard size mortise (non template) Add special door size or bevel changes per door per template	Per Hinge	** \$168	**	\$168
	Spring type /Double Acting (e.g., McKinney 1001)				
	4-1/2"	Per Hinge	HGD** No Charge	HGD**	\$32
	5"	Per Hinge	HGD** \$9	HGD**	\$32
	Non-standard size spring type hinge Add special door size or bevel changes per door per template	Per Hinge	HGD** \$168	HGD**	\$32
	Spring type trucking & bumper set - special reinforcement only (e.g., McKinney CS1 x 35 buffer)	Per Door	\$549		\$148
	NOTE: Special door size or bevel may be required by the hardware manufacturer				
	Electric hinge preparation — hole only (e.g., McKinney ES, CC, CS, MM)	Each	HGE** \$24	EH**	\$24
	Hole and coverbox with knockouts	Each		EH**	\$66
	Security hinge preparation/Institutional (e.g., McKinney HTB786 X HTB386 X PSF)				
	Security stud holes only	Add Per Hinge	HGS** \$24	HGS**	\$24
	Security stud holes with special mortar box	Add Per Hinge		HGS**	\$66
	1/4 x 20 Screw preparation	Add Per Hole	\$9		\$9
	SOSS invisible hinge preparation	Add Per Hinge	HGH \$260	HGH	\$260

***No charge for KD frame, add applies to stick material**

****MAKE NOTE OF HARDWARE MANUFACTURER AND HARDWARE NUMBERS. SUPPLY TEMPLATE INFORMATION WHEN ORDERING**

**Non-Standard or Special
Special Hardware Preps**

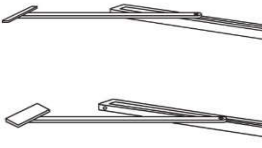
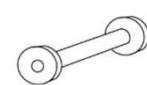
May, 2024

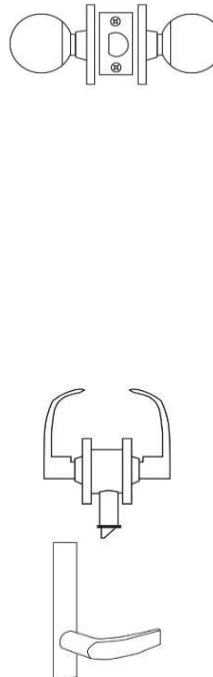
		DOOR CODE NO.	DOOR LIST PRICE ADD	FRAME CODE NO.	FRAME LIST PRICE ADD
HOLDERS					
	Overhead concealed application (e.g., Sargent 690/1530) NOTE: Per template	CH**	\$313	CH**	\$158
	Overhead stop and holder surface mounted (e.g., Sargent 590/1540) NOTE: Per template				
	14 gauge	SH**	\$36	SH**	\$30
	Over 2'4" wide 12 ga. Over 2'4" wide 7 ga.	SH** SH	\$67 \$129	SH** SH**	\$38 \$66
INTERVIEWERS (DOOR PEEP)					
	Hole only, 1/2" or 9/16"	**	\$27		
	All other per template	**	\$27		
	Chime/knocker/viewer	**	\$52		
LIGHT SWITCH					
	Cutout and cover box with knockout			**	\$124
LOCKS					
	Cylindrical 1 3/4 door (ANSI A 115.2) (Gov't 160 - 2 3/4 B.S.)	G1	N/C	E1	\$18*
				E2	\$18*
	Cylindrical 1 3/4 door (ANSI A 115.2) (Gov't 161 - 2 3/4 B.S.)	G2	N/C	E1	\$18*
				E2	\$18*
	Cylindrical 1-3/4 door - lever trim per template (2-3/4 B.S.)	G2A**	N/C	E1	\$18*
	Cylindrical lever thru bolted trim-Universal lever (2 3/4 B.S.)	G2B	N/C	E1	\$18*
			E2	\$18*	
	Cylindrical - 3" - 5" knob backset (Specify special backset dimension)		\$45		
	Mortise Gov't 86 escutcheon plate trim Edge prep - internal lock case Reinforcement - full face ANSI mortise (e.g., Sargent 7700 and 8100 Series) NOTE: Some plate trim will not cover ANSI standard face preparation. Lever handle trim may also conflict. Verify before ordering or use G3A.	G3	N/C	E1	\$18*
	Mortise Gov't 86 edge prep only Blank face Internal lock case reinforcement (e.g., Sargent 7700 and 8100 Series)	G3E0	N/C	E1	\$18*



*No charge for KD frame, add applies to stick material

CONTINUED ON NEXT PAGE

****MAKE NOTE OF HARDWARE MANUFACTURER AND HARDWARE NUMBERS. SUPPLY TEMPLATE INFORMATION WHEN ORDERING**

Non-Standard or Special Special Hardware Preps

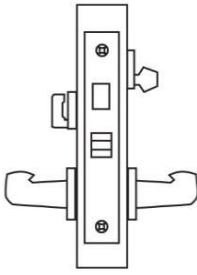
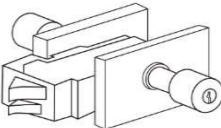
May, 2024

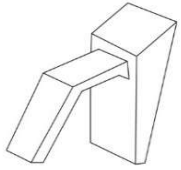
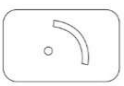
		DOOR CODE NO.	DOOR LIST PRICE ADD	FRAME CODE NO.	FRAME LIST PRICE ADD
LOCKS (CONTINUED)					
    	Mortise Gov't 86 - sectional trim (bevel lock edge only doors) (e.g., Sargent 7700 - 8100 Series) NOTE: The following list is a manufacturer's lock series which qualify as no charge (N/C) sectional trim preparation: e.g., Arrow - A & B Series Best 30 H Series Corbin/Ruswin M2200 Series Falcon M Series Schlage 9000 Series Sargent 7700, 8100 Series ASSA ABLOY ACCENTRA 8000 Series.	**G3A	No Charge	E1	\$18*
	Multiple Mortise Pocket in Close Proximity - charges apply when edge cutout to edge cutout dimension is less than 2"	CM-G3A/G17	\$174		
	Military lock e.g. Kaba Lockmaster	MILL	\$111		
	Mortise Gov't 86 reinforced blank face, edge only	G3AEO	No Charge	E1	\$18*
	Functions requiring master ring cylinders or hotel indicators	**G3A	No Charge	E1	\$18*
	Reinforcement only, blank face, blank edge	G3ARO	No Charge	E1	\$18*
	Uni-rigid-mono 1 3/4 door (e.g., Corbin/Ruswin UT 5200)	G6	\$36	E1	\$18*
	Rim lock - surface mounted door and frame	**	\$83	**	\$24
	Hospital Push Pull Latch (e.g., Sargent 114/116) Special backset included - NOTE HEIGHT	HSP**	\$66	HSP**	\$18
	Lever Trak	**	\$79		

*No charge for KD frame, add is for stick material

CONTINUED ON NEXT PAGE

****MAKE NOTE OF HARDWARE MANUFACTURER AND HARDWARE NUMBERS. SUPPLY TEMPLATE INFORMATION WHEN ORDERING**

		DOOR CODE NO.	DOOR LIST PRICE ADD	FRAME CODE NO.	FRAME LIST PRICE ADD
LOCKS (CONTINUED)					
	Combination Lock	CM	\$174		
	Coded access locks Simplex, Vingcard, Tessa-LD, Unican-ILCO, Saflok Classic	CODE**	\$45	E1	\$18*
	Electric raceway only		\$166		
	*Any lock preparation, for example deadlocks or panic devices, that requires an electric raceway, add raceway price to lock preparation price.				
	Cremone bolt		\$87		\$30
	Security type Jamb lock 2" face frames F.A. NS 400 Series Brinks 3526	EJ2**	\$65	EJ2**	\$122
	Flush mount electrical Junction Box 4" Face Only				\$718
	Junction Box 12" Face Only				\$789
	Door pocket lock (surface mounting plate) F.A. 60, 60K, 70, 10, 80	G30**	\$646	E30**	\$101
	Door non-standard mortise lock F.A. 125, 110	G35**	\$129	E35**	\$88
	Door non-standard lock Strike preparation	STR**	\$81	STR**	\$81

CONTINUED ON NEXT PAGE

*No charge for KD frame, add is for stick material

****MAKE NOTE OF HARDWARE MANUFACTURER AND HARDWARE NUMBERS. SUPPLY TEMPLATE INFORMATION WHEN ORDERING**

**Non-Standard or Special
Special Hardware Preps**

May, 2024

		DOOR CODE NO.	DOOR LIST PRICE ADD	FRAME CODE NO.	FRAME LIST PRICE ADD
LOCKS (DEADLOCKS)					
 	Tubular Gov't 181 (ANSI 115.13) 1 1/2" face hole 1-1/8" wide latchbolt 1-3/4" door	G16	No Add	E4	\$18*
	Mortise Gov't 190 (ANSI 115.5)	**G17	\$87	E3 E4	\$18* \$18*
	Deadlock with threshold bolt	**G17	\$191		
	Tubular non-ANSI	**G34	\$111	**	\$81
	Mortise non-ANSI	G35	\$129		\$81
	If Electric Raceway required			\$166	
	Lock-deadlock combined — interconnected (e.g., Schlage H)	G25	\$58	**	\$58
MAGNETIC LOCK / SHEAR LOCK					
	Full Mortise	MAG**	\$139	MAG**	\$139
	Reinf and holes			MAG**	\$67
DOOR POSITION SWITCH MAGNETIC SWITCH					
	Door position switch Reed switch-magnetic (e.g., Air Teq 6200) 5003	(e.g., Adtec)	DP10***	\$125	DP10*** \$125
	 	Mechanical Actuated type (door position) F.A. 524 Surface frame & door		DP15***	\$40
Mortise door			DP15***	\$95	DP15*** \$65
Concealed position switch type F.A. 523			DP20***	\$156	DP20*** \$212
Door position switch - hole only (contact type) reinf. and hole			DP25*** DP25***	\$31 \$45	
Hole w/elec. C box					DP25*** \$66
	Full mortise magnetic switch		MAG**	\$125	MAG** \$125
MAIL SLOT (DOOR FACE TYPE FMS)					
	Mail slot (Door type FMS) Cut out only		FMS	\$60	
	Cut out with channel		FMS	\$121	
*No charge for KD frame, add is for stick material					
***Pricing does not include top cap charge					
**MAKE NOTE OF HARDWARE MANUFACTURER AND HARDWARE NUMBERS. SUPPLY TEMPLATE INFORMATION WHEN ORDERING					

		DOOR CODE NO.	DOOR LIST PRICE ADD	FRAME CODE NO.	FRAME LIST PRICE ADD
PANIC EXIT DEVICES					
	Rim type — reinforcement only (e.g., Sargent 8800 Series) Surface mounted strike (pairs)	G11	\$46	E8	\$30
	Rim type — Reinforce and fully mortise for function holes (e.g., Sargent 8800 Series) Surface mounted strike (pairs)	**G11	\$46	E8	\$30
	Rim vertical rod — reinforcement only (e.g., Sargent 8710) 3 pt.	**G11A	\$87	E5	\$30
	Surface mounted strike (pairs)	**G11C	\$87	E5	\$30
	Rim vertical rod — fully mortise for function holes (e.g., Sargent 8700) 3 pt.	**G11A	\$87	E5	\$30
	Surface mounted strike 3 pt.	**G11B	\$87	E8, E5	\$60
	Optional - mortise strike in frame	**G11C	\$87	**G20	\$65
	Label fire pin if required (check template)		\$30		
	Mortise panic exit				
	Reinforced and fully mortise for function holes (e.g., Sargent 8900 Series)	**G12	\$87	E1 *	\$18
	Reinforced only — no function holes or edge	G12RO	\$87		
	Reinforced only — edge preparation only	G12EO	\$87		
	Reinforced only — Non standard edge prep	G14	\$297		
	Vert. Rod Exit (surface) edge prep 3 pt	G14B	\$195		
	Vert. Rod Exit (surface) edge prep 2 pt	G14C	\$141		
	(Sargent PP/PR 8700 Series) less bottom rod				
	Concealed vertical rod Reinforced and fully mortise for function holes (e.g., Sargent 8600 Series)	**G12A	\$578	**G20	\$65
Concealed vertical surface applied stk.			**G20	\$30	
Concealed vert. rod — latch top & mortise lock less bottom rod	**G12B	\$578	**G20	\$65	
Concealed vert. rod — latch top only less bottom rod	**G12C	\$578	**G20	\$65	
CVR operated by lever	**G15A	\$578	**G20	\$65	
CVR & mortise deadlock operated by lever	**G15B	\$578	**G20	\$65	
CVR LBR operated by lever	**G15C	\$578	**G20	\$65	
Recessed mounted bar, latch center may be mortise lock	**G13	\$578	E1 *	\$18	
Recessed mounted bar latch top & bottom	**G13A	\$578	**G20	\$65	
Recessed mounted bar — latch top & mortise lock less bottom rod (Sargent LP/LR 8600)	**G13B	\$578	E1 *	\$18	
Recessed mounted bar latch top only	**G13C	\$578	**G20	\$65	
* Add to stick material					



****MAKE NOTE OF HARDWARE MANUFACTURER AND HARDWARE NUMBERS. SUPPLY TEMPLATE INFORMATION WHEN ORDERING**

Non-Standard or Special Special Hardware Preps

May, 2024

		DOOR CODE NO.	DOOR LIST PRICE ADD	FRAME CODE NO.	FRAME LIST PRICE ADD	
	Top and bottom pivot set — single acting (e.g., Rixon 117)	PTS**	\$562	PTS**	\$248	
	Top pivot — frame only preparation			PTT**	\$145	
	Top pivot — door only preparation	PTT**	\$281			
	Intermediate pivot — single acting (e.g., Rixon M19)	Each	PTM**	\$169	PTM**	\$87
	Bottom Pivot (only)		PTB**	\$281	PTB**	\$103
	Bottom Pivot — floor mount frame (e.g., Rixon 117-1/4)		PTB**	\$281		
	Double acting pivot set (e.g., Rixon 127-3/4)		PTS**	\$562	PTS**	\$248
<p>NOTE: see "Floor Closer" also, check hardware requirements for special door bevels. Std. bevel to use with Rixson. Pivot sets are "G" bevel. Other pivot sets require "D" bevel.</p>				Pivot preps are per Hinge Jamb. PTM are per each intermediate pivot. Need 2 jambs for pairs.		
POWER TRANSFER						
	Raceway not included; frame preparation includes coverbox with electric knockouts	EPT**	\$136	EPT**	\$136	
	If raceway required (door)	RW	\$166			
	Raceway required on frame mullion			RW-3	\$111	
	1/2" EMT conduit connector and cover box					
PUSH AND PULL REINFORCEMENT						
	(no preparation in frame)					
	(14 ga std)	G18	\$46			
	7 gauge reinf.		\$128			
PUSH AND PULL BAR REINFORCEMENT						
	(no preparation in frame)	**G18A	\$92			
	(14 ga. std)					
	contact factory for spec. size and gauge requirements					
REMOVABLE MULLION PREP						
	Hardware mullion (e.g., Sargent 980) — reinforcement plate only			G21	\$59	
	Frame soffit width 3" or greater					
	<p>NOTE: Smaller jamb depth frames (soffit less than 3") require a filler block to receive mounting bracket screw hole pattern.</p>			G22**	\$88	
	Verify hardware template with soffit width.					

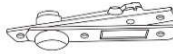
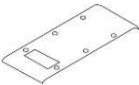
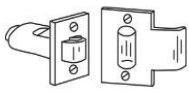
* Add to stick material

		DOOR CODE NO.	DOOR LIST PRICE ADD	FRAME CODE NO.	FRAME LIST PRICE ADD
RESCUE HARDWARE - EMERGENCY STOP					
	Pivots and emergency stop (e.g., McKinney pivots EP5/DS6 stop)				
	pivots-top and bottom	PTS**	\$562	PTS**	\$248
	Emergency stop			ES**	\$77
	Double lip latch strike (e.g., McKinney DL5-8) Strikes must be ordered the same jamb depth of each frame			SDL**	\$168
ROLLER LATCH					
	Non-ANSI A115.1 or 2 (Advise location) (e.g., Glynn Johnson 30/32) Door edge mount or top mount	RL**	\$78	RL**	\$42
ROBE HOOK REINFORCEMENT					
		**	\$36		
SLIDING DOOR (POCKET) HARDWARE REINFORCEMENT					
	NOTE: Reinforce for surface mounted track hardware	SLID	\$161		
STRIKES					
	ANSI prep hole only	E1HO	NC		
	Inactive door, ANSI standard 4 7/8	E1	\$63	E1	\$18*
	ANSI standard 4-7/8 no lip	E1B	\$63	E1B	\$18*
	ANSI standard 4-7/8 extended lip			E1	\$45*
	4-7/8 strike 7 ga. tabs with cover box			E1	\$45*
	Non-ANSI	**	\$81	**	\$81
	ANSI Standard 2 3/4	E2	\$63	E2	\$18*
	Deadlock strike 3-1/2 no lip	E3	\$63	E3	\$18*
	Deadlock strike 2-3/4 no lip	E4	\$63	E4	\$18*
	ANSI standard 4 7/8 on 1 9/16 frame rabbet			E1	\$18*
*No charge for KD frame, add is for stick material		CONTINUED ON NEXT PAGE			
**MAKE NOTE OF HARDWARE MANUFACTURER AND HARDWARE NUMBERS. SUPPLY TEMPLATE INFORMATION WHEN ORDERING					

Non-Standard or Special Special Hardware Preps

May, 2024

		DOOR CODE NO.	DOOR LIST PRICE ADD	FRAME CODE NO.	FRAME LIST PRICE ADD	
STRIKES (CONTINUED)						
	Open back strike (e.g., Sargent 815)	SOB**	\$141			
	Rim type — surface mount and reinforce only	**	\$46	**	\$30	
	Electric strike frame (includes coverbox with knockouts)			**E9	\$111	
	Raceway required on frame mullion			RW-3	\$111	
	1/2" steel flex connector and coverbox					
	(Vertical location of electric strike will vary with hardware. Frames are prepared to match lock used on door at standard location.)					
	Advise lock type when ordering.					
	Electric strike door	E9	\$143			
Electric raceway (Advise routing of raceway) Add	RW	\$166				
SURFACE BOLTS						
	Per door	SB	\$63			
	Frame - face reinforcing door side			H3-A	\$30	
	Frame - stop reinforcing			H3-B	\$30	
MULTI-POINT LOCK - 747 DOOR						
	Concealed vertical rods, top/bottom bolts and mortise lock body cassettes available as factory installed.					
	Sargent 7300 or Corbin Russwin MP6600	G15B*	\$1,003			
	Multi-point strike inactive leaf of a pair	E1*	\$86			
	Multi-point strike - frame lock jamb			E1*	\$101	
	Multi-point strike - frame head			G20*	\$116	
	Note: This product is manufactured offsite and ships separately. Call to verify lead time, freight cost and ship schedule.					
**MAKE NOTE OF HARDWARE MANUFACTURER AND HARDWARE NUMBERS. SUPPLY TEMPLATE INFORMATION WHEN ORDERING						

DESCRIPTION	Page
DOORS	
Astragals	1
Behavioral Healthcare Patient Room Access Doors	1
Bifold Doors	1
Caps — Flush	1
Channel — End Closure	1
CURRISTain Window Molding Options	2
Door Edge Bevels	2-3
Doors (special Width/Height)	3
Door Face Types	3-5
Door Special Width	5
Dutch Door	5
Galvanized Steel — G90 Coating	5
Glass - Factory Installed in Doors	6
Hardware Location (Special)	6
Label Fire Doors	7
Lock Rail	7
Mono Rail Preparation	7
Non Handed Door (B-Bevel)	7
Paint	7
Pocket Door	8
QC Cable	8
Rabbeted Door or Panel Edge	8
Replacement Door	8
2 1/4" (Two and one quarter inch) Thick 747 Door	8
Transom Panels Standard Loose	9
Undercut Door	10
Urethane Core, Slab Type — 707 Door	10
Vertical Stiffeners (Ribs), 18 Gauge — 747 Door	10
Vertical Stiffeners (Ribs), 16 Gauge — 747 Door	10
Vertical Stiffeners (Ribs), 14 Gauge — 747 Door	10
Wicket Door	10
Window Molding Options	11
Window Screens	12
FRAMES	
Anchors	13-14
Asphaltic Back-Coating	14
Cabinet Jamb Frame	14
Communicating Frame	15
Curriseal Frame	15
Custom Profiles (CCW Material Only)	15-16
Dimensions — Non Standard Profile (CCW only)	16

Index

Engineered Section

May, 2024

DESCRIPTION	Page
FRAMES (continued)	
Double Egress	17
Drip Cap	17
Galvanized Steel — G90 Coating	18
Grout Holes in Frame	18
Hardware Location (Special)	18
Hospital Stop (Sanitary Base)	18
Knockdown KD Jamb Miter	18
Labeled Frames	18
Lead-Lined	19
Paint — Prefinish Colors	19
Pocket Door Frame	19
Power Transfer	19
Removable Mullion Prep — Hollow Metal Mullion	19
Rough Buck Frame	20
Silencers	20
Spats Stainless Steel	20
Mercury 3 Thermal Break Frames — 16 or 14 gauge	20
Transom Panel Preparation in Frame	20

UNIT LIST PRICE ADD

ASTRAGALS

	Flat — surface applied with screws (standard)	Add Per Door	\$88
	Surface applied tack -welded	Add Per Door	\$106
	Flat Offset—Surface applied with screws		\$88
	Surface applied tack - welded		\$106
	Z - Type — Surface applied with screws: (standard)		
	Blank	Add Per Door	\$96
	With Strike prep (E1)	Add Per Door	\$159
	With Flush Bolt Prep (H1)	Add Per Door	\$183
	With Strike and Flush Bolt Prep (E1/H1)	Add Per Door	\$246
	Z - Type — surface applied tack-welded		
Blank	Add Per Door	\$104	
With Strike Prep (E1)	Add Per Door	\$167	
With Flush Bolt Prep (H1)	Add Per Door	\$191	
With Strike and Flush Bolt Prep (E1/H1)	Add Per Door	\$254	
See Door Parts Price List for "Loose" Astragals.			

BEHAVIORAL HEALTHCARE PATIENT ROOM ACCESS DOORS

	Price includes wicket door prep, easing of door edges, astragal integrated in face of door, factory install continuous hinge on access door and top cap on patient room door. Type 11, Type 7, or type 4 (thicker glass) kits required for doors with windows.		
	Configurations		
	Standard configuration (1'8" x 5'0" access door standard size)	Add to Base Door Price	\$3,351
Custom configuration (non standard dimensions or sizes)	Add to Base Door Price	\$3,991	

BIFOLD DOORS

	Standard hinge preparation on both vertical edges of door. Square edges - No "Bevel". Check hardware adaptability before ordering.	Add Per Door	\$150
--	--	--------------	-------

CAPS-FLUSH

	Steel - 1 3/4" door:		Std	Options		
			20 Ga	16 Ga.	14 Ga	12 Ga
	Top or bottom installed with screws	Per Cap	\$26	\$31	\$37	\$44
	Top or bottom installed tack-welded	Per Cap	\$68	\$73	\$79	\$86
	Top or bottom installed with screws-seams filled flush	Per Cap	\$75	\$90	\$108	\$130
Top or bottom installed tack-welded-seams filled flush	Per Cap	\$118	\$142	\$170	\$204	

CHANNEL - END CLOSURE (OPTIONAL GAUGES)

Top and bottom - 14 gauge	Per Door	\$74
(Standard size or special size) - 12 gauge	Each Cap	\$74

2
Engineered Doors
Engineered Section

May, 2024



UNIT LIST PRICE ADD

CURRISTAIN WINDOW MOLDING

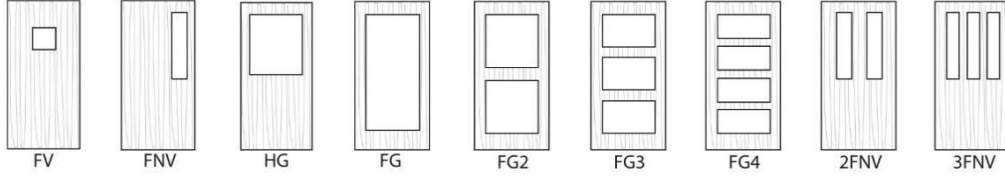

TYPE I (3/8" POCKET)

FV		Add to F Door Price	\$416
FNV		Add to F Door Price	\$489
HG		Add to F Door Price	\$520
FG		Add to F Door Price	\$734
FG2		Add to F Door Price	\$1,276
FG3		Add to F Door Price	\$1,377
FG4		Add to F Door Price	\$1,606
2FNV		Add to F Door Price	\$851
3FNV		Add to F Door Price	\$1,275



TYPE II (5/8", 7/8", 1-1/8" POCKET)

FV		Add to F Door Price	\$602
FNV		Add to F Door Price	\$675
HG		Add to F Door Price	\$706
FG		Add to F Door Price	\$920
FG2		Add to F Door Price	\$1,648
FG3		Add to F Door Price	\$1,935
FG4		Add to F Door Price	\$2,350

DOOR EDGE BEVELS - SEE TECHNICAL DATA MANUAL

"A" Bevel square	HINGE	LOCK	1/8" in 2" Standard Door Bevel	Add Per Door	No Charge
"B" Bevel-square	HINGE	LOCK	Square Edge Door Non bevel square edges	Add Per Door	No Charge
"D" Bevel 1/8" in 2"	HINGE	LOCK	1/8" in 2"	Add Per Door *	\$454
1/8" in 2" bevel hinge, 1/4" radius low side, 1/8" in 2" bevel lock rail (required for some pivot hardware)					
"E" Bevel - 2 5/8" radius	HINGE	LOCK	2 5/8" radius	Add Per Door *	\$736
Bull Nose both Edges					
"F" Bevel - 2 5/8" radius	HINGE	LOCK	square	Add Per Door *	\$368
Bull Nose one Edge					

UNIT LIST PRICE ADD

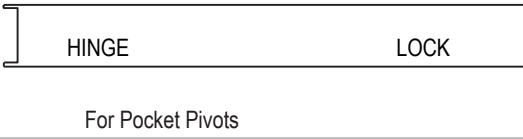
DOOR EDGE BEVELS - SEE TECHNICAL DATA MANUAL (continued)					
"G" Bevel - 1/8" in 2"		1/8" in 2"	Add Per Door *		\$18
"P" Bevel Recessed Hinge Edge		1/8" in 2"	Add Per Door		Included in Pocket Pivot Prep
"Q" Bevel Recessed Hinge Edge		square	Add Per Door		Included in Pocket Pivot Prep

NOTE: D, E, F, and G bevels are required with some pivots, floor closers and double acting door hardware. Check hardware templates for bevel requirements.
 * Price adds do not include pivots, floor closer, etc... See Hardware Section.

DOOR FACES

Common sizes and locations are published in the Technical Data Manual.
 Please contact factory for special shapes and odd sizes.
 Prices include standard rim-type window molding, type 9 standard or optional type 1, prepared to receive 1/4" glass, (3/8" pocket) only unless noted cutout only. Please note exact cutout size required if different than CURRIES standard. Louvers are priced in door parts section. "Cutout" only 707 doors that exceed 36" in height of the cutout require surround channel reinforcing. Cutouts less than 36" in height do not require the channel unless the kit or louver manufacturer's procedure states this requirement for fire listed products. Please specify when ordering cutout only.

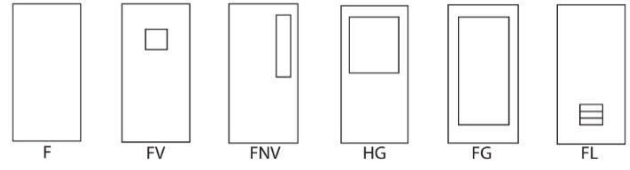

F	Flush	See Price Page	
FV (up to 50" perimeter visible glass)	FV - Vision 3/8" pocket	Add to F Door Price	\$228
	FV - cutout only	Add to F Door Price	\$81
	FV - cutout and surround with 20 ga. Channel	Add to F Door Price	\$142
	18 or 16 ga. channel	Add to F Door Price	\$155
	14 ga. channel	Add to F Door Price	\$168
FNV (over 50"; to 86" perimeter visible glass including 6 x 54)	FNV - Narrow vision 3/8" pocket	Add to F Door Price	\$255
	FNV - cutout only	Add to F Door Price	\$81
	FNV - cutout and surround with 20 ga. channel (Channel surround used on label doors with windows exceeding 36" in height or 707 doors where window is greater than 50% of area of door face)	Add to F Door Price	\$142
	18 or 16 ga. Channel	Add to F Door Price	\$155
	14 ga. channel	Add to F Door Price	\$168
	12 ga. channel	Add to F Door Price	\$192

CONTINUED ON NEXT PAGE

**Engineered Doors
Engineered Section**

May, 2024



			UNIT LIST PRICE ADD
DOOR FACES (continued)			
HG (over 86"; to 144" perimeter visible glass)	Half glass 3/8" pocket	Add to F Door Price	\$298
	HG - cutout only	Add to F Door Price	\$81
	HG - cutout and surround with 20 ga. channel (Channel surround used on label doors with windows exceeding 36" in height or 707 doors where window is greater than 50% of area of door face)	Add to F Door Price	\$142
	18 or 16 ga. Channel	Add to F Door Price	\$155
	14 ga. channel	Add to F Door Price	\$168
	12 ga. channel	Add to F Door Price	\$192
HG2	Half glass 2 lite 3/8" pocket (steel muntin)	Add to F Door Price	\$335
HG3	Half glass 3 lite 3/8" pocket (steel muntin)	Add to F Door Price	\$437
HG4	Half glass 4 lite 3/8" pocket (steel muntin)	Add to F Door Price	\$536
HG6	Half glass 6 lite 3/8" pocket (steel muntin)	Add to F Door Price	\$737
HG9	Half glass 9 lite 3/8" pocket (steel muntin)	Add to F Door Price	\$967
FG (over 144" perimeter visible glass)	Full Glass 3/8" pocket	Add to F Door Price	\$420
NOTE: 5 1/2" minimum stile and rail with standard rim-type window molding. Smaller stile and rail dimensions can be achieved using concealed molding - priced later in this section. Contact factory for minimum stile and rail.			
FG	Full Glass - cutout and surround with 20 ga. channel	Add to F Door Price	\$255
FL	Flush Louver - cutout only	Add to F Door Price	\$81
F2L	Flush 2 Louver - top and bottom - cutout only	Add to F Door Price	\$162
	NOTE: 1) Label doors with louvers (price louvers separate) require perimeter 20 ga. channel reinforcement	Add to F Door Price	\$142
	NOTE: 2) All vision-type doors - FV, FNV, HG with louver cutout also.	Add to Vision Door Price	\$81
FGL	Full louver - cutout and surround with 20 ga. channel NOTE: price louvers separate	Add to F Door Price	\$255
FG2	Full glass 2 lite 3/8" pocket (type 9 standard or optional type 1*)	Add to F Door Price	\$596
FG3	Full glass 3 lite 3/8" pocket (type 9 standard or optional type 1*)	Add to F Door Price	\$782
FG4	Full glass 4 lite 3/8" pocket (type 9 standard or optional type 1*)	Add to F Door Price	\$968
FG9	Full glass 9 lite 3/8" pocket steel muntin (type 9 standard or optional type 1*)	Add to F Door Price	\$1,169
FG12	Full glass 12 lite 3/8" pocket steel muntin (type 9 standard or optional type 1*)	Add to F Door Price	\$1,597
FG15	Full glass 15 lite 3/8" pocket steel muntin (type 9 standard or optional type 1*)	Add to F Door Price	\$2,034
FG18	Full glass 18 lite 3/8" pocket steel muntin (type 9 standard or optional type 1*)	Add to F Door Price	\$2,462
FD	Dutch door flush	Add to F Door Price	\$358
* Includes 20 ga. surround channel			
NOTE: For dutch doors with vision lights or louvers, use the dutch door flush price and add to the appropriate face-type door price.			

CONTINUED ON NEXT PAGE

UNIT LIST PRICE ADD

DOOR FACES (continued)			
FP	Viewer, 1/2" or 9/16" hole only	Add to F Door Price	\$27
	All others prepared per template - hole only	Add to F Door Price	\$27
FMS	Mail slot - prep only (see std. sizes)		
	Cutout only (standard)	Add to F Door Price	\$60
	Cutout with channel reinf.(upon request)	Add to F Door Price	\$121
FRV	Round vision 12" pocket (10" diameter visible)	Add to F Door Price	\$1,239
FRV1	Round vision 18" pocket (16" diameter visible)	Add to F Door Price	\$2,015
FRV2	Round vision 24" pocket (22" diameter visible)	Add to F Door Price	\$2,068
FRV	Cutout only - specify size	Add to F Door Price	\$209
2FNV	2 narrow lites	Add to F Door Price	\$510
3FNV	3 narrow lites	Add to F Door Price	\$765
DUTCH DOOR			
	NOTE: Labeled Dutch Door — use label door price and add	Dutch Door Add	\$358
	Flush bolt strike in Shelf H2		\$60
	Hole only in shelf or top cap		\$30
	1 Flush bolt in Top Leaf Edge		\$61
	Lock Prep to Bottom Leaf		\$252
	in Bottom Leaf or Shelf (shelf price in parts section)		\$164
DOORS (SPECIAL WIDTH)			
	See each price page for oversize capabilities. Price the next standard size of door.	No Add for Special Widths	
GALVANIZED STEEL - G90 COATING			
	a) 68 HEIGHT	Add to Door Price	\$354
	b) 70 HEIGHT	Add to Door Price	\$361
	c) 72 HEIGHT	Add to Door Price	\$367
	d) 80 HEIGHT	Add to Door Price	\$373
	e) 90 HEIGHT	Add to Door Price	\$382
	f) 100 HEIGHT	Add to Door Price	\$395

NOTE: Steel stiffened door faces with G90 may not be aesthetically eye pleasing - price includes epoxy primer

**Engineered Doors
Engineered Section**

May, 2024



GLASS - FACTORY INSTALLED

Price includes glass installed in doors with glazing tape as required.
 Prices below reflect glass and installation only.
 Price does not include cutout or lite kit.
 Exterior doors include cap beads on both sides. Use appropriate order code for exterior doors.
 Sizes other than listed must be quoted through the factory.

DOOR FACE TYPES	.25" TEMPERED	.25" FILMED WIRE	KERALITE® FILMED	KERALITE® LAMINATED	5/8" IGU	1" IGU
ORDER CODES INTERIOR EXTERIOR	(FIG01) (FIG01E) *	(FIG02) (FIG02E) *	(FIG03) (FIG03E) *	(FIG04) (FIG04E) *	N/A (FIG07E)	N/A (FIG08E)
FV	\$267	\$512	\$752	\$1,094	\$596	\$601
FV1	\$267	\$512	\$752	\$1,094	\$596	\$601
FNV	\$267	\$512	\$848	\$1,440	\$596	\$601
FNV1	\$267	\$512	\$1,271	\$2,160	\$596	\$601
FNV2	\$267	\$512	\$1,526	\$2,592	\$596	\$601
FNV3	\$267	\$512	\$1,695	\$2,880	\$596	\$601
FNV4	\$267	\$512	\$932	\$1,584	\$596	\$601
FNV5	\$267	\$512	\$932	\$1,584	\$596	\$601
FNV6	\$267	\$512	\$932	\$1,584	\$596	\$601
FNV7	\$267	\$512	\$1,187	\$2,016	\$596	\$601
FNV8	\$267	\$512	\$1,271	\$2,160	\$596	\$601
FNV9	\$267	\$512	\$932	\$1,584	\$596	\$601
HG 3068	\$347	\$1,819	\$3,892	\$7,613	\$837	\$847
HG 3070	\$347	\$1,819	\$3,892	\$7,613	\$837	\$847
FG 3068	\$548	\$2,887	\$8,472	\$10,292	\$1,303	\$1,310
FG 3070	\$548	\$2,887	\$8,472	\$10,292	\$1,303	\$1,310

Notes:
 Rectangular/square glass only
 Contact factory for availability of glazing not listed above
 All insulated/exterior glass will be installed with cap bead
 Fire rating limitations on glazing may limit availability on some doors
 FireLite® NT Standard and FireLite Plus also available - factory quote only
 Detail for each glass type available in Tech Manual
 Installed glass will not be available with 607, 737, 757, 777 or Stile and Rail series doors. Also not available on StormPro products Divided lites are not available
 * D & E label, exterior, and insulated glass doors will all include cap bead on both sides - Add \$180 to installed glass price

HARDWARE LOCATION (SPECIAL)

Doors other than CURRIES standard hardware location	No Charge
---	-----------

UNIT LIST PRICE ADD

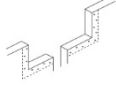
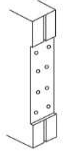
LABEL FIRE DOORS			
	U.L. - A, B, C, G	Code L	Add Per Door \$65
	U.L. - Transom panel add	Code OTP	Add Per Door \$65
	U.L. - 20 minute	Code U20	Add Per Door \$17
	W.H.I. - A, B, C, G	Code W	Add Per Door \$17
	W.H.I. - 20 minute	Code W20L	Add Per Door \$17
	Curries Construction Label Doors or panels Code LC		Add Per Door \$24
	NOTE: "Label" doors for further processing are available to CURRIES licensed second location manufacturers. Price standard stock door. Add closer reinforcement if required.		
	Code FP		No Charge
LOCK RAIL			
	12 GA. (707-747)		\$152
MONO RAIL PREPARATION			
		Advise size required, furnished with rubber gasket seal to be field fit.	Add Per Leaf \$433
NON-HANDED DOOR			
		Square edges - no bevel, hinges cut through both faces. NOTE: Specify N.H. for hand, 4 1/2" hinge only.	No Charge
		Ultima preparation for use with standard weight .134 or heavy weight .180 hinge, 4-1/2"	No Charge
PAINT			
			Composite Core Steel Stiffened
	Pre-finish Colors		607,707 727 747,757,777 847,857
	Standard Color & Finish		
	1-10 Doors	Add Per Door	\$180 \$289
	11+ Doors	Add Per Door	\$144 \$252
	Non-standard color or finish, or color match of existing paint sample		
	1-10 Doors	Add Per Door	\$269 \$387
	11+ Doors	Add Per Door	\$224 \$338
	NOTE: Standard delivery time not guaranteed due to paint curing time requirements. Extended delivery is common (for non-standard colors - allow for extended delivery contact factory)		
	Red Oxide prime paint in lieu of standard gray prime	Add Per Door	\$90
	2 Coats Standard Gray Prime	Add Per Door	\$90
	2 Coats White Primer (for light colored top coats)	Add Per Door	\$90
	Zinc Rich Primer (heavy zinc solid content paint)	Add Per Door	\$334
	2 Component Epoxy prime paint	Add Per Door	\$90
	Curries Pre-finish paint is only available with a gloss rating of 5-15% reflectance using a 60° gloss meter (eggshell-like finish). A maximum gloss rating of 20% reflectance is recommended to reduce show through characteristics on steel doors and frames per ANSI-SDI A250.8 and HMMA 802.		

UNIT LIST PRICE ADD

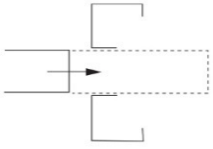
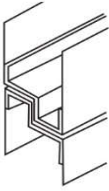
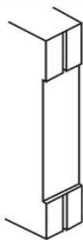
POCKET DOOR (SEE TECHNICAL DATA MANUAL FOR DETAILS)			
	Reinforce for surface mounted track hardware	Add Per Door	\$159
	Edge Pull preparation	Add Per Door	\$92
QC CABLE (ELECROLYNX HARNESS) POWER OVER ETHERNET (PoE) AVAILABLE			
	1st Harness	Add Per Door	\$166
	2nd Harness	Add Per Door	\$166
RABBETED DOOR OR PANEL EDGE (SEE TECHNICAL DATA MANUAL FOR DETAIL)			
	Top or bottom edge	Add Per Door	\$623
REPLACEMENT DOOR - BLANK EDGES AND FACE - SQUARE (NO BEVELS)			
	Available 707 and 747 only - 1 3/4", any width, any height		
	3 hinge prep up to 7'6"	Add Per Door	\$31
	4 hinge prep over 7'6" and up to 10'	Add Per Door	\$42
2" (TWO INCH) THICK DOOR - SEE 857 SERIES			
2 1/4" (TWO AND ONE QUARTER INCH) THICK 747 DOOR			
	Add to 747 Door Price		\$1,740
	WINDOW OPTIONS—Type 3 or Type 4 only for door thickness listed above		

TRANSOM PANELS STANDARD LOOSE

(See Technical Manual for size and edge limitations)

Transom Panels (loose)

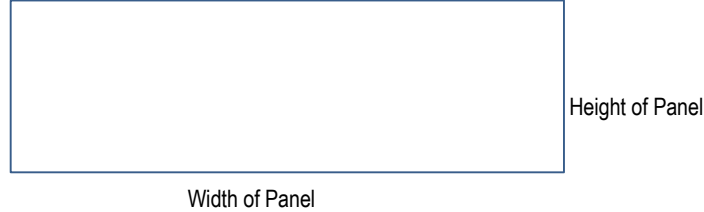

Example:

1/2" Thick Panel. 20 gauge steel. Width of panel is 2'1". Height of Panel is 11". Round up to the nearest foot for both Width and Height. That will give the total square feet of the Panel. Square feet of panel times price per square feet.

3 (2'1" rounded up to 3') Width X 1 (11" rounded up to 1') = 3 square feet. 3 X \$49 (price per square foot for 20 gauge 1/2" panel) = \$147 list.

Indicate "B" bevel panel, for use in three sided or four sided frames.

Refer to Technical Manual for maximum capabilities and uses.

MINIMUM PRICE OF 3 SQUARE FEET

PANEL THICKNESS	STEEL GAUGE	CONSTRUCTION	FIRE RATED	CR PER SQ FT PRICE
3/8", 1/2", 5/8" 3/4", 7/8", or 1"	20	Composite	N/A	\$51
3/8", 1/2", 5/8" 3/4", 7/8", or 1"	18	Composite	Yes**	\$62
3/8", 1/2", 5/8" 3/4", 7/8", or 1"	16	Composite	Yes**	\$100
3/8", 1/2", 5/8" 3/4", 7/8", or 1"	14	Composite	N/A	\$126
1-3/4"	20	707S Styrene	N/A	\$77
1-3/4"	18	707S Styrene	No	\$88
1-3/4"	16	707S Styrene	No	\$105
1-3/4"	14	707S Styrene	No	\$140
1-3/4"	18	707S Honey***	Yes*	\$88
1-3/4"	16	707S Honey***	Yes*	\$105
1-3/4"	14	707S Honey***	Yes*	\$140
1-3/4"	18	747S*	Yes*	\$107
1-3/4"	16	747S*	Yes*	\$127
1-3/4"	14	747S*	Yes*	\$165

*For UL Label 1-3/4" Add \$65

**For UL Label 1/2" panel only. 18 ga only if panel to be installed in a door. 18 or 16 ga if installed in a frame
Add \$65

Panel installation charge – welded into frame or installed with screws or removable Add Per Panel Fixed= \$180 Removable = \$132

3/8" or 1/2" panel installed in normal glass pocket in door window kit Add Per Panel Fixed= \$144

Galvanneal (A40) Panel Add \$48
Galvanneal (A60) Panel Add \$103

747 Panels *Add 12 ga. Rails \$152
***Add honeycomb core \$44
***Add QMAX core \$148

Engineered Doors
Engineered Section

May, 2024



ASSA ABLOY

		UNIT LIST PRICE ADD
UNDERCUT DOOR		
	5/8" BOTTOM STANDARD 1-3/4" DOOR - 3/8" & 3/4" AVAILABLE all other undercuts	No Charge \$24
		Add Per Door
QMAX CORE - SLAB TYPE - 707 DOOR		
	(Label approved, UL only) up to 9'0"	\$148
		Add Per Door
VERTICAL STIFFENERS (RIBS)		
	20 Gauge - 747 and 777 Door	\$65
	18 Gauge - 747 and 777 Door	\$93
	16 Gauge - 747 Door	\$212
	14 Gauge - 747 Door	\$287
		Add To 747 Door Price
WICKET DOOR		
		\$1,712
		Add Per Door

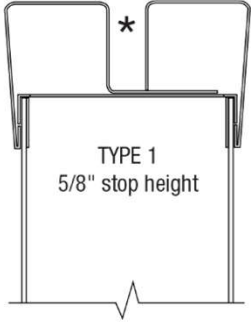
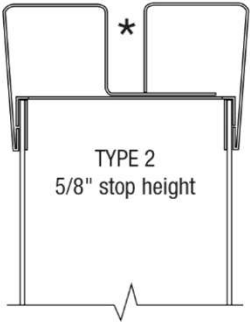
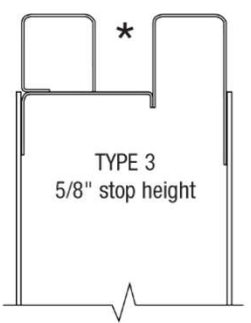
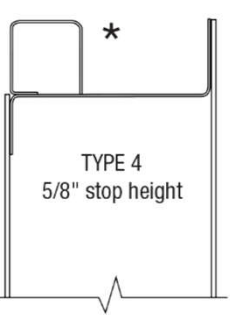
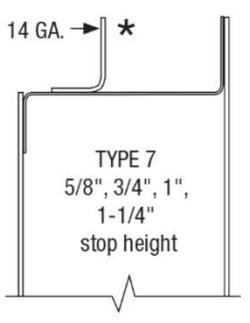
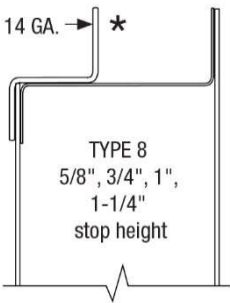
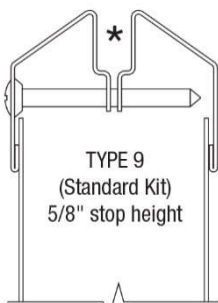
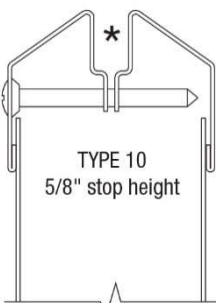
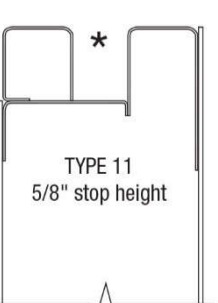
WINDOW MOLDING TYPES (ADD TO FLUSH DOOR PRICE)									
 <p>TYPE 1 5/8" stop height</p>		 <p>TYPE 2 5/8" stop height</p>		 <p>TYPE 3 5/8" stop height</p>		 <p>TYPE 4 5/8" stop height</p>		 <p>TYPE 7 5/8", 3/4", 1", 1-1/4" stop height</p>	
* POCKET SIZE 3/8" ONLY FOR 1-3/4" DOORS		* POCKET SIZE 5/8", 7/8" AND 1-1/8" FOR 1-3/4" DOORS		* POCKET SIZE 3/8", 1/2" AND 5/8" FOR 1-3/4", 2" OR 2-1/4" DOORS		* POCKET SIZE 3/8" THRU 1-1/8" FOR 1-3/4", 2" OR 2-1/4" DOORS		* POCKET SIZE 3/8", 1/2" AND 5/8" FOR 1-3/4" DOORS, 2" DOORS	
FV	\$228	FV	\$347	FV	\$311	FV	\$497	FV	\$512
FNV	\$255	FNV	\$374	FNV	\$354	FNV	\$540	FNV	\$594
HG	\$298	HG	\$417	HG	\$419	HG	\$605	HG	\$726
FG	\$420	FG	\$539	FG	\$683	FG	\$869	FG	\$1,151
FG2	\$596	FG2	\$715	FG2	\$838	FG2	\$1,210	FG2	\$1,573
FG3	\$782	FG3	\$901	FG3	\$1,257	FG3	\$1,815	FG3	\$2,360
FG4	\$968	FG4	\$1,087	FG4	\$1,676	FG4	\$2,420	FG4	\$3,146
#6 SCREW		#6 SCREW		#6 SCREW		#6 SCREW		#6 X 3/4 SCREW	
 <p>TYPE 8 5/8", 3/4", 1", 1-1/4" stop height</p>		 <p>TYPE 9 (Standard Kit) 5/8" stop height</p>		 <p>TYPE 10 5/8" stop height</p>		 <p>TYPE 11 5/8" stop height</p>		REFER TO CURRIES TECHNICAL DATA MANUAL FOR WINDOW LOCATION, REINF. GAUGES, SCREW PLACEMENT AND POSSIBLE HARDWARE INTERFERENCE.	
* POCKET SIZE 3/8" THRU 1-5/8" FOR 1-3/4" OR 2" DOORS		* POCKET SIZE 3/8" ONLY FOR 1-3/4" DOORS ONLY		* POCKET SIZE FOR 1-3/4" DOORS ONLY 9/16", 13/16" and 1-1/16"		* POCKET SIZE 3/8", 1/2" AND 5/8" FOR 1-3/4", 2" OR 2-1/4" DOORS			
FV	\$512	FV	\$228	FV	\$347	FV	\$311		
FNV	\$594	FNV	\$255	FNV	\$374	FNV	\$354		
HG	\$726	HG	\$298	HG	\$417	HG	\$419		
FG	\$1,151	FG	\$420	FG	\$539	FG	\$683		
FG2	\$1,573	FG2	\$596	FG2	\$715	FG2	\$838		
FG3	\$2,360	FG3	\$782	FG3	\$901	FG3	\$1,257		
FG4	\$3,146	FG4	\$968	FG4	\$1,087	FG4	\$1,676		
#6 X 3/4 SCREW		#8 SCREW		#8 SCREW		#6 SCREW			

Engineered Doors
Engineered Section

May, 2024



			UNIT LIST PRICE ADD
WINDOW SCREENS			
	For HG - type doors, aluminum screen, and perimeter frame to fit pocket in standard HG door.	Add To HG Door	\$301
	NOTE: Glass glazing is not possible when using screens, specialty and/or security screens available - contact factory.		

ANCHORS						
ANCHORS FOR M AND CM FRAMES (WITH KD FRAME)						
Six anchors standard up to 7'6" per frame						
Eight anchors per frame over 7'6" to 10'0"						
All prices listed as each						
CODE	FRAME FACE	3 - 4 5/8	4 3/4 - 9 3/4	9 7/8 - 14	Profile	
MP	2" only	NA	Std	NA	M or CM	Loose
AMP	2" only	\$3	\$3	NA	M or CM	Loose
M	ALL	Std	Std	Std	M only	Loose
MW	ALL	Std	Std	Std 12" max.	M or CM	Loose
SC*	ALL	Std	Std	Std	M or CM	Loose
WS	ALL	\$3	\$3	\$3	M only	Loose
WML	ALL	\$9	\$9	\$9	M or CM	Welded
WSC	ALL	\$6	\$6	\$6	M or CM	Welded
WWS	ALL	\$6	\$6	\$6	M or CM	Welded
WESC	ALL	\$6	\$6	\$6	M or CM	Welded

* 5-3/4 SC/Steel Channel is no charge for 2" face frame only (PO149).

ANCHORS - LOOSE		
Standard jamb anchors are included in the KD frame price for M-series and CM-series frames. These standard anchors are MW /Masonry wire, M /Masonry T, SC /Steel channel, and MP/multi-purpose type anchors.	MP Each \$3.00	SC Each \$3.00
	AMP Each \$3.00	WS Each \$3.00
	M Each \$3.00	ML Each \$6.00
	MW Each \$3.00	

ANCHORS - WELDED IN						
ML / Masonry label, SC /Steel channel, WS / Wood stud anchors are available welded in place by prefixing the anchor code with a W .						
The cost of the welding must be added to the KD frame price.						
Welding = \$3.00 Each						
Standard loose anchor price is included in these per jamb price.						
			SC	WS	ML	MP
3 per jamb	Add per jamb for welded anchors		\$9.00	\$9.00	\$9.00	\$9.00
4 per jamb	Add per jamb for welded anchors		\$12.00	\$12.00	\$12.00	\$12.00

All KD Double Egress (DEM), and single rabbet **G** and **CG** profile KD frames are supplied with loose anchors as specified, included in the base price or welded in for \$3.00 extra per anchor, except existing wall type anchors that are priced separately.

Add per anchor	\$3.00			
----------------	--------	--	--	--

CONTACT FACTORY FOR OTHER TYPES OF ANCHORS TO BE WELDED IN.

CONTINUED ON NEXT PAGE

UNIT LIST PRICE ADD

ANCHORS (CONTINUED)

EXISTING WALL TYPE ANCHORS FOR M AND CM FRAMES

EWA/existing wall type anchor, SB/Spacing bracket anchor, and PS/pipe spacer anchors

Available for M and CM series frames

Chart below based on these prices

EWA Anchors	\$3.00	ea. loose
PS Anchors	\$9.00	ea. loose
SB Anchors	\$3.00	ea. loose

(Holes required to install 1/4" or 3/8" bolt in frame stop-Specify bolt size)

Welding in per anchor, add to the anchor cost

Bolts with expansion shield (Specify bolt size)

ANCHOR/QUANTITY	HOLES ONLY			HOLES AND ANCHORS			HOLES, ANCHORS, 1/4" OR 3/8" BOLTS			1/4" OR 3/8" BOLTS ONLY		
	6	8	10	6	8	10	6	8	10	6	8	10
LOOSE												
EWA 1/4" or 3/8" *	\$18	\$24	\$30	\$36	\$48	\$60	\$102	\$136	\$170	\$66	\$88	\$110
PS 1/4" or 3/8"	\$54	\$72	\$90	\$72	\$96	\$120	\$138	\$184	\$230	\$66	\$88	\$110
SB 1/4" or 3/8"	\$18	\$24	\$30	\$36	\$48	\$60	\$102	\$136	\$170	\$66	\$88	\$110
WELDED												
WEWA 1/4" or 3/8"	N/A	N/A	N/A	\$48	\$64	\$80	\$114	\$152	\$190	\$66	\$88	\$110
WPS 1/4" or 3/8"	N/A	N/A	N/A	\$120	\$160	\$200	\$186	\$248	\$310	\$66	\$88	\$110
WSB 1/4" or 3/8"	N/A	N/A	N/A	\$48	\$64	\$80	\$114	\$152	\$190	\$66	\$88	\$110

* EWA - 2" face maximum, and 8 3/4" jamb depth maximum. PS anchors must be used on larger face dimensions and jamb depths.

Specify bolt length 4" or 6", and quantity per frame, if bolts are required.

6 or 8 anchors standard up to 7'6" frame height. Over 7'6" to 10'0" receive 10 anchors.

C FRAME ANCHORS - Drywall frames include one compression bar anchor per jamb located near the top, and punch and dimple base anchor preparations on each face at the bottom. An optional welded in strap type anchor is available for \$25 add/frame, when specifying OB/optional base anchor in the anchor column.

C.C.W. MATERIAL - Open section profile stick prices do not include anchors. Loose or weld in type anchors can be estimated from tables on the preceding page. Closed mullion section prices, prepared for hinge or strike, include a mullion stirrup anchor loose for the bottom.

ASPHALTIC BACK-COATING

3-Sided Frames	Add Per Frame	\$153
Individual Frame Pieces - Open Profile	Add Per Frame Piece	\$51
Individual Frame Pieces-Closed Profile (Mullion)	Add Per Frame Piece	\$74

CABINET JAMB FRAME

	Cabinet jamb frame (see Technical Data Manual for details)		
	Price door frame from CCW material. Add perimeter footage of buck being used.		
	16 Gauge Buck	Add Per Lineal Foot	\$26
	14 Gauge Buck	Add Per Lineal Foot	\$26
	12 Gauge Buck	Add Per Lineal Foot	\$26
	Add for Welded 3 Sided Frame		\$250
NOTE: Available saw mitre only (S.M.O.) jambs and heads or saw mitre welded (S.M.W.) jambs and heads. Bucks furnished loose to dimensions of rough opening specified			

UNIT LIST PRICE ADD

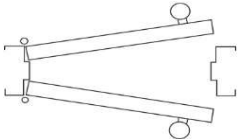
COMMUNICATING FRAME		
	See Technical Data Manual for profiles	
	(Standard KD profile only)	Add Per Frame No Charge

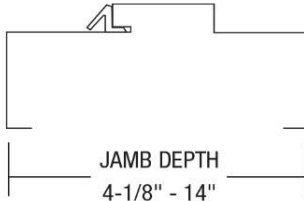
CURRISEAL FRAME				
	Integral kerf frame to receive gasket for air infiltration, smoke and draft control, and weather seal. The gasket sets are Architectural bronze color only.			
		Add per frame	\$174	
		CCW lengths per kerf per foot	\$15	
		GASKET SETS		
		STOCK NUMBER	SIZE	
		MS004028	3072	\$49
		MS004036	4080	\$57
		MS004044	6072	\$57
	MS004051	8072	\$62	
	MS004069	6080	\$62	
	MS004077	8' length 50 pcs	\$1,125	
	MS007070	8' length 1 pc	\$27	
	NOTE: Communicating frames require two sets of gaskets			
		Double the Frame Add		

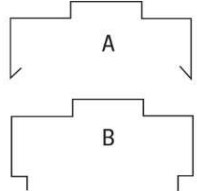
CUSTOM PROFILES (CCW MATERIAL ONLY) SAW MITRE ONLY			
	Cut to length, butt end, notched, or saw mitre only - available in most jamb depths, faces, stop height, and gauges as shown below. (See Technical Data Manual for limitations on each profile. Contact factory for availability and on label capabilities).		
	Profile A (Plaster Return)	Add Per Frame Component	\$30
	Profile B (Nailing Flange)	Add Per Frame Component	\$30

CONTINUED ON NEXT PAGE

UNIT LIST PRICE ADD

CUSTOM PROFILES (Continued) - CCW material only (SAW MITRE ONLY)

	Profile 275 and 355	Add Per Frame Component	\$102
	NOTE: Available 16 gauge only, 3F only * Jamb Depth		
		Add Per Frame Component	\$99
	Profile H (Radius Face)	Add Per Frame Component	\$73
	NOTE: Available 16 gauge only, 3F only		
	Profile I (Flush Hemmed Face Edge)	Add Per Frame Component	\$45
	NOTE: Available 18, 16, and 14 gauge only		
	Profile L (Shadow Box, Flush Face)	Add Per Frame Component	\$45

DIMENSIONS - NON STANDARD PROFILE (CCW only. For KD pricing see frame section) - DOES NOT APPLY TO 12 GA., THERMAL BREAK, OR STAINLESS STEEL

1)	Non standard stop height 3/4", 1", or 1 1/4"	Add Per Frame Component	15%
2)	Non standard rabbet dimension	Add Per Frame Component	15%
3)	Non standard face dimension (less than 2") (1", 1 1/4", 1 1/2", 1 3/4" are standard)	Add Per Frame Component	15%
4)	For face dimension larger than standard 8" face up to 16" add 25% to 8" price	Add Per Frame Component	25%
5)	Non standard returns (backbend) NOTE: standard return is 1/2" - except 5 3/4 has 7/16" return, all M series. 1/2" is the minimum return on 12 gauge material	Add Per Frame Component	15%
6)	Drywall return (backbend)	Add Per Foot - Both Returns	\$ 0.80
		Add Per Foot - One Return	\$ 0.40

UNIT LIST PRICE ADD

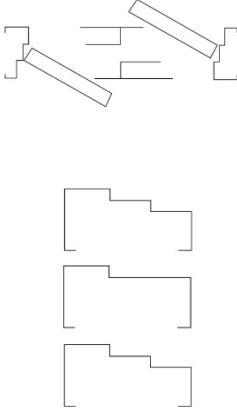
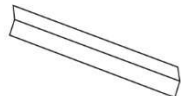
DOUBLE EGRESS			
	Knocked down KD - M series 4 3/4" thru 14", 1/8" increments, 16 or 14 gauge steel.		
	Price standard W.H.I. or U.L. frames or parts as follows:		
		Add Per Hinge Jamb	\$146
		Add Per Splice/Welded, Head	\$291
		Add Per Complete Frame	\$583
	NOTE: Vertical Rod devices required for fire label openings.		
		CCW stick length - Double egress hinge jamba	Add Per Foot \$29
		CCW stick length - double egress, single rabbet head	Add Per Foot \$29
		CCW stick length - double egress double rabbet head	Add Per Foot \$29
	(Add cut and notch charges and weld charges as required)		
DRIP CAP			
	Installed per frame — welded frames only	\$56	
	Drip Cap 10'6-5/8" – painted 16 ga.	Loose - priced per foot \$7	

**Engineered Frames
Engineered Section**

May, 2024



			UNIT LIST PRICE ADD
GALVANIZED STEEL - G90 COATING			
	Add to 3F KD Frame		\$93
	Add Per KD Frame Piece Each		\$31
	CCW - price per foot		\$6.18
GROUT HOLES IN FRAME			
	1 3/8" hole for grouting (backfill) installed frame	Each	\$24
	Foam Grout Guard	Add Per Frame	\$19
HARDWARE LOCATION (Special)			
	Frame to other than CURRIES standard hardware location.		No Charge
HOSPITAL STOP (Sanitary Base) Specify Height			
	45° cut above finish floor is standard — 90° cut available at the same price.		
	Factory fabricated and finished	Add Per Frame	\$195
	Factory fabricated and finished	Add Per Jamb	\$97.50
	Stop filler & back plate without foot clip	Each	\$23
	Stop filler, back plate & foot clip	Each	\$26
	NOTE: W.H.I./U.L. frames with hospital stops must be factory finish or done by W.H.I./U.L. second location license shop. 6" maximum height on W.H.I./U.L. frames.		
KNOCKDOWN - KD JAMB MITER			
	Additional jamb miter for KD borrow lite or four sided frames	Add Per KD Jamb	\$17
	Used in perimeter pricing		
LABELED FRAMES			
U.L. FRAMES - METAL LABEL			
	KD hinge jamb	Code L	\$29
	KD per single frame	Code L	\$29
	KD per double frame (pairs require additional positive latch in head)	Code L	\$58
	KD or welded borrowed lite	Code L	\$29
	20 min. KD per hinge jamb	Code 20	\$29
W.H.I. FRAMES			
	KD hinge jamb embossed label (no hourly rating or 1 1/2 hr)	Code W	No Charge
	KD hinge jamb - metal label with rating	3 Hr. Code W-180	\$29
		1 1/2 hr Code W-90	\$29
		1 hr Code W-60	\$29
		3/4 hr Code W-45	\$29
		20 min. Code W-20	\$29
	CURRIES Construction Label KD Frames	Code CON	\$29
		Add to Hinge Jamb	
SMOKE LABEL			
	Smoke Label		\$29

UNIT LIST PRICE ADD

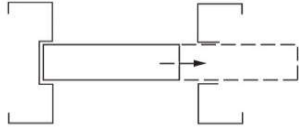
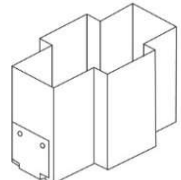
PAINT - PREFINISH COLORS				
	KD Frames		Standard	Custom
	1-30 Pieces	Add Per Piece	\$60	\$76
	31+ Pieces	Add Per Piece	\$45	\$61
	Welded Frames			
	1-30 Pieces	Add Per Piece	\$74	\$93
	31+ Pieces	Add Per Piece	\$55	\$70
	Factory pre-finished touch up paint is available and can be ordered separately on your pre-finished frame order. Adder is for a 1 gallon can of touch of paint, must be ordered separately.		\$278	\$278
	All welded prefinish frames will be crated. Up to five 3-sided frames in a crate (maximum 6'0" x 7'0" frames) All 3-sided frames above 6'0" x 7'0" and other elevations will ship one frame per crate.	Add Per Crate	\$165	
	NOTE: (Non standard colors, allow for extended delivery schedule contact factory.)			
	Red Oxide Prime Paint, in lieu of standard gray prime	Add Per Piece	\$39	
	2 Coats Standard Gray Prime	Add Per Piece	\$39	
	Zinc Rich Prime (heavy zinc solid content paint)	Add Per Piece	\$39	
	2 Coats white primer (for light colored topcoats)	Add Per Piece	\$39	
POCKET DOOR FRAME				
	See Technical Data Manual for details			
	NOTE: Available saw mitred only (S.M.O.) or saw mitre welded (S.M.W.)			
	Price as CCW material per lineal perimeter foot of plain rail (CCW21) and add	Per Perimeter Foot	\$36	
	* Glass stop for head rail (CCW 177 PM) 5/8" x 5/8"	Add Per Foot	\$10.10	
POWER TRANSFER - MULLION PREP				
	1/2" Steel conduit and connector, and cover box (RW-3)	Add Per Mullion	\$111	
REMOVABLE MULLION PREP - HOLLOW METAL MULLION				
	Vertical or horizontal mounting			
	Preparation includes: 2 removable mullion bracket anchors, and both ends of mullion notched		\$199	
	Price mullion separately			
	Notches in adjoining frame sections (See Technical Data Manual for details)	Add Per Mullion	\$17	

		UNIT LIST PRICE ADD	
ROUGH BUCK FRAME			
	Rough Buck Frame (See Technical Data Manual for details) NOTE: Available saw butt end (S.B.E.) only		
	W.H.I./U.L. Rough Buck Frame NOTE: Available Saw Butt End (S.B.E.) only. Price rough buck frame.		
	Add for Label Per Hinge Jamb		
	U.L. Metal (not including sub buck)	\$29	
	WHI Metal	\$29	
	Price door frame from CCW material. Add perimeter footage of buck being used.		
	16 gauge Buck Add Per Lineal Foot	\$25.80	
	14 gauge Buck Add Per Lineal Foot	\$36.00	
12 gauge Buck Add Per Lineal Foot	\$39.00		
SILENCERS			
<p>All frames, strike jambs, and double heads may be ordered punched for silencers at no charge when indicated on the frame order form. Hole punching is three per single frame or strike jamb and two per double frame or double opening head. Silencers are not furnished and must be ordered separately from the Frame Parts Section of this catalog. Frames, strike jambs and double heads may also be ordered blank for use with adhesive silencers or weather strip. All Service Center inventory frames are punched for silencers.</p>		Refer to "Frame Parts" section for pricing silencers.	
SPATS STAINLESS STEEL			
	Slip in sleeve type (See Technical Data Manual for details)		
	Applied - cased opening - Hospital stop	Add Per Spat	\$265
	Applied - full profile (rabbet and stop)	Add Per Spat	\$347
	Loose - See Parts Section		
	4" - 8" max.		
MERCURY 3 (16ga or 14ga) THERMAL BREAK FRAMES			
	Galvannealed A60 & G90 steel standard, galvanized optional		
	KD TB3 or TR3 only		
	Add to KD Galvanneal Frame Price - up to 10'0"		\$804
	FW Welded Mercury 3 frames are face and rabbet welded only (soffit is not welded)		
	CCW Pricing Thermal Break - 16 gauge or 14 gauge		
	Open sections	Add to A60, G90 Foot Price	\$47.29
Closed sections	Add to A60, G90 Foot Price	\$73.31	
TBF3, TRF3 (16 gauge or 14 gauge)	Stucco frame profile 3-7/8" minimum depth	Add to 3F Mercury 3 frame price	\$5.94
TRANSOM PANEL PREPARATION IN FRAME			
	Prep for transom panel with springbolts	Per frame	\$136
	Prep for removable transom panel	Single opening	\$136
	Prep for removable transom panel	Paired opening	\$148

DESCRIPTION	PAGE
DOOR PARTS	
Astragal	1
Cylindrical Lock Cover Plate	1
Dutch Door Shelf	1
End Channel	1
Glass - Lite Kits	
Stock Item - Type 9	2
Standard Size Available - Type 9	2
Non Standard Sizes Made to Order - Type 9	2
Non Standard Sizes Made to Order - Type 10	3
Standard Size Available - Type 1	3
Non Standard Sizes Made to Order - Type 1	4
Non Standard Sizes Made to Order - Type 2	4
Glass Muntin Bar	5
Hardware Reinforcements	5
Hinge Filler Plates	5
Lock and Flush Bolt Filler Plates	5
Louvers	
Stock Item	6
Special Sizes	6
Stock Item	6
Molding	
Stick Molding Parts - Type 9 and 10	6
Glass Molding Parts - Type 1 and 2	7
Top and Bottom Caps — Steel	7
Window Cut-out Channel Reinforcing	7
FRAME PARTS	
Closer Reinforcement	8
Coordinator Reinforcement	8
Continuous Drip Cap	8
Continuous Header Reinforcement	8
Corner Clip Reinforcements	8
Corner Return Filler	9
Door Silencer	9
Flush Bolt Reinforcement	9
Hinge Filler Plates	9
Hinge Shims	9
Hinge Reinforcements	9
Lead Lined Frame Clips	10
Lock Strike/Filler Plates	10
Lock Strike Reinforcements	10
Mud Cover Hinge or Strike Reinforcement	10
Panic Exit Device Reinforcement	10
Splicing Reinforcements	10
Spats — Stainless Steel	11
Spreader Bar Reinforcement Channel	11
Stop Filler Head	11
Throat Filler	11

Index

Loose Parts



May, 2024

DESCRIPTION	PAGE
FRAME PARTS (continued)	
"C" Drywall Frames	
Cased Opening — Compression Anchor	12
Drywall Frames — Compression Anchor	12
Adjustable Multi-Purpose Anchor	12
Multi-Purpose — Slip - In	12
"M" Masonry Frames	
Adjustable Ceiling Strut	13
Double Egress	
(2) Piece Foot Clip	13
Steel Stud, Channel Type, Slip-In	13
Steel Stud, Channel Type, Weld-In	13
Wood Stud, Slip-In	13
Wood Stud, Weld-In	13
EWA Anchor	13
Existing Opening	
Spacing Bracket	14
3/8" Diameter, Pipe Spacer Only	14
Concealed with Plastic Cap	14
Foot Clip, Standard	14
Foot Clip, Adjustable	14
Masonry "T"	14
Multi-Purpose — Slip-In	14
Removable Mullion Bracket	14
Spline Anchor	15
Steel Stud	
Channel Type, Slip-In	15
Stirrup Anchors Mullion	15
Weld-In — Masonry	15
Wire Masonry Anchor	16
Wood Stud	
Slip-In	16
Weld-In	16
MISCELLANEOUS PARTS	
Asphaltic Back-Coating	17
Dies — Frame Cutouts	17
Primer (Field Touch-ups)	17
Punch Sets for Roper Whitney Hand Press	17
Screws and Bolts	18
Touch-Up Paint (Pre-finished Colors)	18

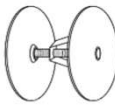

DESCRIPTION	PAGE
TEMPLATES	
Door Hardware Cut-Out Templates	
Hinge Drill Fixture	19
Latch Bolt	19
Latch Front	19
Dead Lock Strike	19
Mortise Strike	19
Cylinder Lock Strike	19
Frame Hardware Cut-Out Templates	
Hinge	20
Mortise Strike	20
Cylinder Lock Strike	20
Strike	20

Notes
Loose Parts
May, 2024

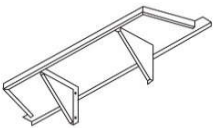
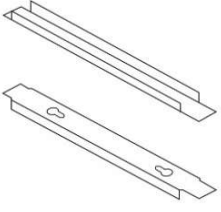

		PART NO.	LIST PRICE
ASTRAGALS			
	(Specify Height & Hand)		
	Flat (1-1/2" x 12 gauge)	F1	\$48
	Flat Offset	part #163	\$56
	Z, Blank	Z1	\$56
	Z, ANSI 4-7/8" Strike Preparation	Z1E1	\$119
	Z, Blank Strike, ANSI Flush Bolt Preparation	Z1H1	\$143
	Z, ANSI 4-7/8" Strike, ANSI Flush Bolt Preparation	Z1E1H1	\$206
	Z, ANSI 4-7/8" Strike, ANSI Flush Bolt Preparation, Non-Beveled	Z1E1H1NB	\$206
	Z, ANSI 4-7/8" Strike, Non-Beveled	Z1E1NB	\$119
CYLINDRICAL LOCK COVER PLATE/FILLER			
	Cylindrical lock cover plate - ANSI 115.2 & 3	CD000182	\$23
	Cylindrical lock filler - #161 Lock, Face Punchout	CD000262	\$8
DUTCH DOOR SHELF - 16 GAUGE			
	(Specify Door Width & Door Thickness)		
	2'0" through 4'0" - single shelf (one side) 8" wide shelf	SHF1	\$358
	2'0" through 4'0" Double Shelf (both sides) 8" wide shelf	SHF2	\$488
	2'0" through 4'0" single sheet (one side) greater than 8" wide	SHFD	\$430
	2'0" through 4'0" double shelf (both sides) greater than 8" wide	SHFD	\$586
	RK	Add Per Shelf	\$103
	*Use part no. for all widths - specify shelf width if other than 8" standard required.		
END CHANNEL			
	Top Channel—2' min. - 4' max.	EC01T*	\$37
	(Specify Door Width & Door Thickness)		
	8'-0" Lengths		\$65
Bottom Channel—2' min. - 4' max. (Specify Door Width & Door Thickness)	(Specify Door	EC02B* *Use Part No. for all widths as indicated.	\$37
*Additional charges may apply for welding			

		PART NO.	LIST PRICE	
GLASS - LITE KITS TYPE 9 (STANDARD KIT) STANDARD SIZES AVAILABLE				
	(Preassembled & Prime Painted, screws included, 1-3/4" door only — 1/4" thick glass, 3/8" pocket)			
	FV	10 x 10	WN1ASST	\$109
	FV1	12 x 12	WN1ASST	\$109
	FNV	6 x 16	WN2ASST	\$136
	FNV1	6 x 36	WN2ASST	\$136
	FNV2	6 x 48	WN2ASST	\$136
	FNV3	6 x 54	WN2ASST	\$136
	FNV4	3 x 33	WN2ASST	\$136
	FNV5	4 x 24	WN2ASST	\$136
	FNV6	5 x 20	WN2ASST	\$136
	FNV7	6 x 24	WN2ASST	\$136
	FNV8	6 X 30	WN2ASST	\$136
	FNV9	4 X 25	WN2ASST	\$136
	HG	23-5/16 x 27-1/4" (3068 door)	WN3ASST	\$179
	HG	23-5/16 x 31-1/4" (3070 door)	WN3ASST	\$179
	HG	23-5/16 x 33-1/4" (3072 door)	WN3ASST	\$179
	FG	23-5/16 x 59-3/8" (3068 door)	WN4ASST	\$191
	FG	23-5/16 x 63-3/8" (3070 door)	WN4ASST	\$191
FG	23-5/16 x 65-3/8" (3072 door)	WN4ASST	\$191	
GLASS - LITE KITS TYPE 9 (STANDARD KIT)				
	NON STANDARD SIZES MADE TO ORDER			
	(Preassemble & Prime Painted, screws included, 1-3/4" only - 1/4" glass, 3/8" pocket)			
	FV	Specify "visible" width x height	WN6ASSP	
	FNV	Specify "visible" width x height	WN7ASSP	
	HG	Specify "visible" width x height	WN8ASSP	
	FG	Specify "visible" width x height	WN9ASSP	
Non standard visible glass size kits are priced per perimeter inch of visible glass opening.		Per Inch	\$2.73	
*Additional charges may apply for welding				

		PART NO.	LIST PRICE	
GLASS - LITE KITS TYPE 10 (STANDARD KIT)				
	Non standard pocket size made to order			
	FV	10 x 10	WN1AS1S	\$228
	FV1	12 x 12	WN1AS1S	\$228
	FNV	6 x 16	WN2AS1S	\$255
	FNV1	6 x 36	WN2AS1S	\$255
	FNV2	6 x 48	WN2AS1S	\$255
	FNV3	6 x 54	WN2AS1S	\$255
	FNV4	3 x 33	WN2AS1S	\$255
	FNV5	4 x 24	WN2AS1S	\$255
	FNV6	5 x 20	WN2AS1S	\$255
	FNV7	6 X 24	WN2AS1S	\$255
	FNV8	6 X 30	WN2AS1S	\$255
	FNV9	4 X 25	WN2AS1S	\$255
	HG	23-5/16 x 27-1/4 (3068 door)	WN3AS1S	\$298
	HG	23-5/16 x 31-1/4 (3070 door)	WN3AS1S	\$298
	HG	23-5/16 x 33-1/4 (3072 door)	WN3AS1S	\$298
	FG	23-5/16 x 59-3/8 (3068 door)	WN4AS1S	\$310
FG	23-5/16 x 63-3/8 (3070 door)	WN4AS1S	\$310	
FG	23-5/16 x 65-3/8 (3072 door)	WN4AS1S	\$310	
GLASS - LITE KITS TYPE 10 (STANDARD KIT)				
	NON STANDARD SIZES MADE TO ORDER			
	(Preassemble & Prime Painted, screws included, 1-3/4" only - 1/4" glass, 3/8" pocket			
	FV	Specify "visible" width x height	WN6AS1P	
	FNV	Specify "visible" width x height	WN7AS1P	
	HG	Specify "visible" width x height	WN8AS1P	
	FG	Specify "visible" width x height	WN9AS1P	
Non standard visible glass size kits are priced per perimeter inch of visible glass opening			Per Inch \$5.70	
GLASS - LITE KITS TYPE 1 (OPTIONAL KIT) STANDARD SIZES AVAILABLE				
	(Preassembled & Prime Painted, screws included, 1-3/4" door only — 1/4" thick glass, 3/8" pocket) Specify 1-3/4" or 1-3/8" door when ordering.			
	FV	10 x 10	WN1KTST	\$109
	FV1	12 x 12	WN1KTST	\$109
	FNV	6 x 16	WN2KTST	\$136
	FNV1	6 x 36	WN2KTST	\$136
	FNV2	6 x 48	WN2KTST	\$136
	FNV3	6 x 54	WN2KTST	\$136
	FNV4	3 x 33	WN2KTST	\$136
	FNV5	4 x 24	WN2KTST	\$136
	FNV6	5 x 20	WN2KTST	\$136
	FNV7	6 X 24	WN2KTST	\$136
	FNV8	6 X 30	WN2KTST	\$136
	FNV9	4 X 25	WN2KTST	\$136
	HG	23-13/16 x 28 (3068 door)	WN3KTST	\$179
	HG	23-13/16 x 32 (3070 door)	WN3KTST	\$179
	HG	23-13/16 x 34 (3072 door)	WN3KTST	\$179
	FG	23-13/16 x 60-1/8 (3068 door)	WN4KTST	\$191
FG	23-13/16 x 64-1/8 (3070 door)	WN4KTST	\$191	
FG	23-13/16 x 66-1/8 (3072 door)	WN4KTST	\$191	

*Additional charges may apply for welding

PART NO.	LIST PRICE
----------	------------

GLASS - LITE KITS TYPE 1 (OPTIONAL KIT)

<p>3/8" pocket width</p>	NON STANDARD SIZES MADE TO ORDER (Preassemble & Prime Painted, screws included)			
	Specify 1-3/8" or 1-3/4" door when ordering — 1/4" glass , 3/8" pocket			
	FV	Specify "visible" width x height	WN6KTSP	
	FNV	Specify "visible" width x height	WN7KTSP	
	HG	Specify "visible" width x height	WN8KTSP	
	FG	Specify "visible" width x height	WN9KTSP	
Non standard visible glass size kits are priced per perimeter inch of visible glass opening.			Per Inch	\$2.73

GLASS - LITE KITS TYPE 2 (OPTIONAL KIT)

<p>5/8", 7/8", or 1 1/8" pocket width</p>	Non standard pocket size made to order, 1-3/4" only			
	FV	10 x 10	WN1KT1S	\$228
	FV1	12 x 12	WN1KT1S	\$228
	FNV	6 x 16	WN2KT1S	\$255
	FNV1	6 x 36	WN2KT1S	\$255
	FNV2	6 x 48	WN2KT1S	\$255
	FNV3	6 x 54	WN2KT1S	\$255
	FNV4	3 x 33	WN2KT1S	\$255
	FNV5	4 x 24	WN2KT1S	\$255
	FNV6	5 x 20	WN2KT1S	\$255
	FNV7	6 x 24	WN2KT1S	\$255
	FNV8	6 X 30	WN2KT1S	\$255
	FNV9	4 X 25	WN2KT1S	\$255
	HG	23-13/16 x 28 (3068 door)	WN3KT1S	\$298
	HG	23-13/16 x 32 (3070 door)	WN3KT1S	\$298
	HG	23-13/16 x 34 (3072 door)	WN3KT1S	\$298
	FG	23-13/16 x 60-1/8 (3068 door)	WN4KT1S	\$310
FG	23-13/16 x 64-1/8 (3070 door)	WN4KT1S	\$310	
FG	23-13/16 x 66-1/8 (3072 door)	WN4KT1S	\$310	

GLASS - LITE KITS TYPE 2 (STANDARD KIT)

<p>5/8", 7/8", or 1-1/8" Pocket Width</p>	NON STANDARD SIZES MADE TO ORDER (Preassemble & Prime Painted, screws included, 1-3/4" only)			
	FV	Specify "visible" width x height	WN6KT1P	
	FNV	Specify "visible" width x height	WN7KT1P	
	HG	Specify "visible" width x height	WN8KT1P	
	FG	Specify "visible" width x height	WN9KT1P	
	Non standard visible glass size kits are priced per perimeter inch of visible glass opening			Per Inch

***Additional charges may apply for welding**

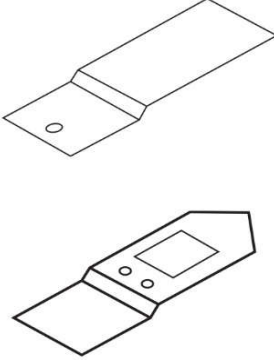
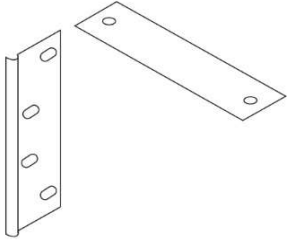
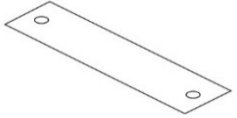
		PART NO.	LIST PRICE
GLASS MUNTIN BAR - FOR TYPE 9 STANDARD OR TYPE 1 OPTIONAL KITS			
	Steel Muntin (10'6" Long) - 1/4" glass only primed	CD002402	\$141
	This product is not listed for use in fire doors.		
HARDWARE REINFORCEMENTS			
	Astragal Flush-Bolt Tab, .036 Offset, 8-32 Tap	DE0032	\$11
	Astragal Strike Tab,.036 Offset, 12-24 Tap	DE0031	\$11
	Flush-Bolt Guide Reinforcement — top or bottom, 8-32	DE0024	\$21
	Door Flush-Bolt Tab, No offset, 8-32 Tap	DE0025	\$11
	Mortise Deadlock Tab, No Offset, 10-24 Tap	DE0014	\$11
	Mortise Lock Tab, .100 Offset, 12-24 Tap	DE0007	\$11
	Door Strike Tab, No Offset, 12-24 Tap	DE0022	\$11
	Strike Tab, No Offset, 8-32 Tap	DE0023	\$11
	4-1/2" Hinge Reinforced Plate, 1-1/4 x 10 x 7 gauge Flat	DH0006	\$14
	5" Hinge Reinforced Plate, 1-1/4 x 10 x 7 gauge Flat	DH0007	\$14
	1-3/4" Blank Hinge Rail 8'-0", 14 gauge	DH0023	\$44
	1-3/4" Blank Lock Rail 8'-0", 14 gauge	DE0062	\$44
	Latch Bolt Guide, 161 Preparation	CD010162	\$11
	Latch Bolt Reinforcement Plate, 161 Preparation	DE0003	\$18
HINGE FILLER PLATES / HINGE SHIMS			
	4-1/2" x 1-1/2" x .134	CD002572	\$17
	HINGE SHIMS		
	4-1/2" Hinge Ultima - non handed shim filler (.0478 thick)	CD008852	\$10
	4-1/2" Hinge Filler Replacement Door (.0478 thick)	CD016772	\$10
	4-1/2" Hinge Ultima - Handed Door (.0478 thick)	CD025502	\$10
	Hinge Shim Retainer Clip	CD008772	\$8
	4-1/2" Metal Shim (.0478 thick)	CF003157	\$10
LOCK AND FLUSH BOLT FILLER PLATES			
	8" x 1-1/4" x .219 (ANSI 115.1), 86 Lock Edge Filler	CD002732	\$19
	2-1/4" x 1-1/8" x .134 (ANSI 115.2), 161 Lock Edge Filler	CD002812	\$15
	2-1/4" x 1" x .134 (ANSI 115.3), 160 Lock Edge Filler	CD002992	\$15
	6-3/4" x 1" x .1875 (ANSI 115.4), Flush Bolt Edge Filler	CD003072	\$19
*Additional charges may apply for welding			

Door Parts
Loose Parts

May, 2024

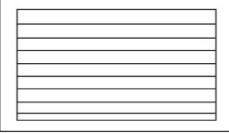
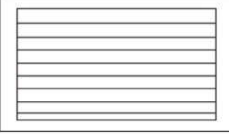
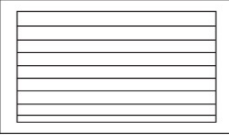

		PART NO.	LIST PRICE
LOUVERS - STOCK ITEM			
	(UL) FUSIBLE LINK — 1-3/4 DOORS ONLY)		
	12" W x 12" H (FL) Galvannealed	CD004062	\$892
	18" W x 12" H (FL2) Galvannealed	CD004142	\$892
	20" W x 12" H (FL3) Galvannealed	CD004222	\$892
	24" W x 12" H (FL 4) Galvannealed	CD004302	\$892
	24" W x 24" H Galvannealed	CD004482	\$892
LOUVERS - SPECIAL SIZES			
	(UL) Fusible Link	LV01FL	Contact Factory
	(Standard Type — 2 piece Z blade)	V02	Contact Factory
	NOTE: Non Stock Direct Ship Louvers are priced at factory — plus freight cost, from louver factory.		
LOUVERS - STOCK ITEM			
	(1 piece inverted "Y" Louver — Standard Type, 1-3/4 Doors)		
	12" W x 12" H (FL) Galvannealed	CD005132	\$236
	18" W x 12" H (FL2) Galvannealed	CD005472	\$276
	20" W x 12" H (FL3) Galvannealed	CD005622	\$343
	24" W x 12" H (FL4) Galvannealed	CD005962	\$331
	24" W x 18" H Galvannealed	CD006042	\$385
	24" W x 24" H Galvannealed	CD006122	\$468
	24" W x 60" H (FGL) Galvannealed	CD006202	\$1,006
	24" W x 64" H (FGL) Galvannealed	CD006382	\$1,145
MOLDING - STICK MOLDING PARTS FOR TYPE 9 AND 10 (STANDARD KITS)			
(Galvannealed - Unpainted - Butt End)			
(Non-Punched and Non-Dimpled)			
Type 9 for 3/8 Pocket Long Leg Piece (95.0" long)	WM09	\$52	
Type 10 Profile A Long leg Piece (95.0" long)	WM10A	\$77	
Type 10 Profile B Long Leg Piece (95.0" long)	WM10B	\$77	
Corner Clip Type 9 Long Leg Piece (3/8 Pocket)	WM09C	\$7	
Corner Clip Type 10 Long Leg Piece (9/16, 13/16, 1-1/16 Pockets)	WM10C	\$7	
UL Sub Channel Clip - Spec Door Thickness	WM04	\$7	
3/8 pockt requires a WM09 on both inside and outside pieces			
9/16 pocket requires a WM10A on both inside and outside pieces			
13/16 pocket requires a WM10A on one side and a WM10B on the opposite side			
1-1/16 pocket requires a WM10B on both inside and outside pieces			
*Additional charges may apply for welding			

		PART NO.	LIST PRICE
MOLDING - GLASS MOLDING PARTS TYPE 1 AND 2 (OPTIONAL KITS)			
	(Galvannealed - Unpainted - Butt End)		
	3/8 pocket Long Leg Piece (8'0" Long - Part A) fixed	WM03A	\$53
	3/8 pocket Short Leg Piece (8'0" Long - Part B) removable	WM03B	\$53
	5/8 pocket long Leg Piece (6'0" Long - Part A) fixed	WM08A	\$78
	5/8 pocket Short Leg Piece (6'0" Long - Part B) removable	WM08B	\$78
	7/8 pocket long Leg Piece (6'0" Long - Part A) fixed	WM06A	\$78
	7/8 pocket Short Leg Piece (6'0" Long - Part B) removable	WM06B	\$78
	1-1/8 pocket Long Leg Piece (6'0" Long - Part A) fixed	WM07A	\$78
	1-1/8 pocket Short Leg Piece (6'0" Long - Part B) removable	WM07B	\$78
	UL Sub Channel Clip - Spec Door Thickness	WM04	\$7
Corner Clip	WM05	\$7	
TOP AND BOTTOM CAPS - 20 GAUGE STEEL			
	(Specify Width of Steel Door Cap & Door Thickness)		
	Galvanneal Cap, A60	TCO1*	\$25
	(Note on order if to be used for 727 or 857 doors)		
Length 8'0"		*Use Part No. for all widths as indicated	\$64
TOP AND BOTTOM CAPS - 24 GAUGE STEEL			
	Snap in type	Per 20	See Service Center parts inventory \$359
WINDOW CUT-OUT CHANNEL SURROUND REINFORCING			
	20 gauge, 7 foot lengths		DW0019 \$46
*Additional charges may apply for welding			

Frame Parts



Loose Parts

May, 2024

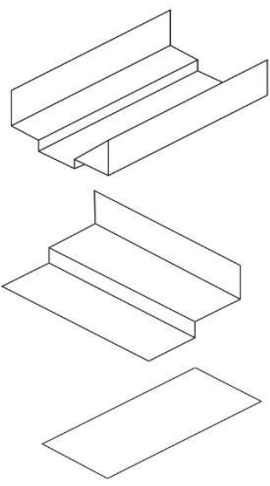
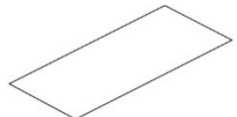
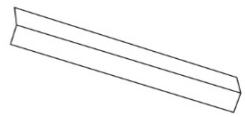
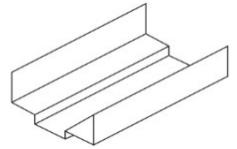
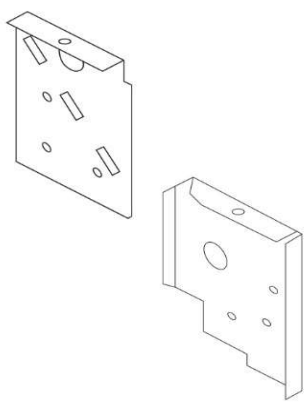

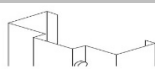
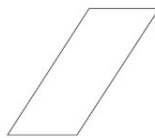
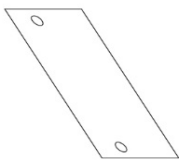
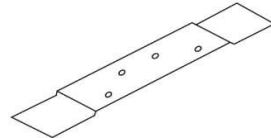
		PART NO.	LIST PRICE
CLOSER REINFORCEMENTS			
	Full Profile Slip-In (16" long x 12 gauge) (Specify Jamb Depth)	FL0009	\$43
	Half Profile Slip-In (16" Long x 12 gauge)		
	1-15/16" Rabbet x 3/4" Soffit Leg	FL0011	\$36
	1-15/16" Rabbet x 1-1/4" Soffit Leg	FL0010	\$36
	1-9/16" Rabbet x 3/4" Soffit Leg	FL0011	\$36
	1-9/16" x 1-1/4" Soffit Leg	FL0010	\$36
	Strip Type Reinforcement		
	10" x 1-3/4" Strip, 14 gauge (regular arm)	FL0857	\$12
	16" x 1-3/4" Strip, 14 gauge	FL0863	\$12
	24" x 1-3/4" Strip, 14 gauge	FL0861	\$15
	20" x 1-1/4" Strip (Parallel Arm), 14 gauge	FL0814	\$15
	5" x 5/8" Parallel Arm Block - 1-15/16" Rabbet	FL0028	\$15
	5" x 5/8" Parallel Arm Block - 1-9/16" Rabbet	FL0029	\$15
COORDINATOR REINFORCEMENT			
	1-3/8" x 15-1/2" x 12 gauge	G23CR	\$10
	1-3/8" x 10" x 12 gauge	G24CR	\$10
CONTINUOUS DRIP CAP			
	Installed per frame - welded frames only		\$53
	Drip cap 10'6-5/8" - painted 16 ga.	Per Foot	\$10
CONTINUOUS HEADER REINFORCEMENT			
	Refer to Flush Stick (CCW-92) Section of the Catalog for ordering and pricing information	See CCW-92	
CORNER CLIP REINFORCEMENTS			
	1" Face Masonry Jamb (per pair)	P0031	\$8
	1-1/4" Face Masonry Jamb (per pair)	P0032	\$8
	1-1/2" Face Masonry Jamb (per pair)	P0033	\$8
	1-3/4" Face Masonry Jamb (per pair)	P0034	\$8
	2" Face Masonry Jamb (per pair)	P0035	\$8
	4" Face Masonry Head (per pair)	P0037	\$8
	1-1/2" Face Drywall Jamb (per pair)	P0017	\$8
	1-3/4" Face Drywall Jamb (per pair)	P0016	\$8
	2" Face Drywall Jamb (per pair)	P0036	\$8
	2" Face Drywall Jamb, 14 gauge frame (per pair)	P0046	\$8
	4" Face Drywall Head, 16 gauge frame (per pair)	P0071	\$8
	4" Face Drywall Head, 14 gauge frame (per pair)	P0047	\$8
Corner Clip, break-off tool	MS004119	\$60	
*Additional charges may apply for welding			

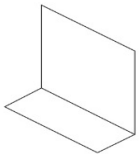
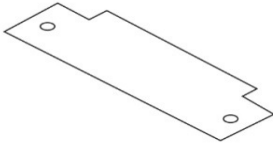
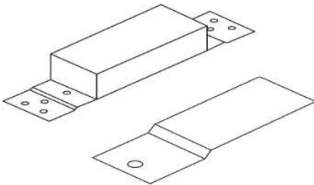
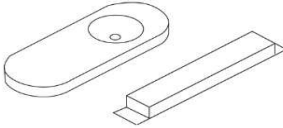
		PART NO.	LIST PRICE
CORNER RETURN FILLER			
	(Specify Frame Profile, Gauge, Face & Return Dimension)	P0084	\$8
	Corner Filler (per pair)		
DOOR SILENCER			
	3M Adhesive	Pkge of 1000	CF000187 \$219
	Push-In Type #650	Pkge of 1000	CF000267 \$588
	Push-In Type	Pkge of 50	CF018007 \$37
	Plastic Silencer Hole Plugs	List Each	CF000347 \$6
FLUSH BOLT REINFORCEMENT			
	H1 Reinforcement only, 1-1/4" x 8" x 12 gauge (No hole, No Mortise)		H1FBR \$13
	H3 Bolt Reinforcement, 1-3/8" x 10" x 12 gauge		H3ASBR \$13
	H2, H4 Tab, .031 Offset, 8-32 Tap		FL0033 \$8
	H5 Non-Handed Flush Bolt, 8-32 Tap		CF003727 \$16
HINGE FILLER PLATES / HINGE SHIMS			
	4-1/2" x 1-5/8" x .134 Filler		CF000677 \$16
	HINGE SHIMS		
	4-1/2" Hinge Shim (.0478 thick)		CF003157 \$10
	5" Hinge Shim (.0478 thick)		CF003237 \$10
HINGE REINFORCEMENTS			
			
	4" x .130 x 7 gauge x .065 Offset with Mud Cover		401SCND \$22
	4" x .130 x 7 gauge x .065 Offset		401SNCND \$14
	4-1/2" x .134 x 7 gauge x .075 Offset with Mud Cover		451SCND \$22
	4-1/2" x .134 x 7 gauge x .075 Offset		451SNCND \$14
	4-1/2" x .134 x 7 gauge x .060 Offset with Mud Cover		451SCND4 \$22
	4-1/2" x .134 x 7 gauge x .060 Offset		451SNCND4 \$14
	4-1/2" x .180 x 7 gauge x .113 Offset with Mud Cover		451HCND \$22
	4-1/2" x .180 x 7 gauge x .113 Offset		451HNCND \$14
	4-1/2" x .180 plus shim x 7 Ga. x .113 Offset with Mud Cover		U451HCND \$22
	4-1/2" x .180 plus shim x 7 gauge x .113 Offset		U451HNCND \$14
	5" x .146 x 7 gauge x .079 Offset with Mud Cover		501SCND \$22
	5" x .146 x 7 gauge x .079 Offset		501SNCND \$14
	5" x .190 x 7 gauge x .123 Offset with Mud Cover		501HCND \$22
	5" x .190 x 7 gauge x .123 Offset		501HNCND \$14
	Anchor Hinge — 7 gauge, 2 pieces (no drill or tap)		FH0030 \$34
*Additional charges may apply for welding			

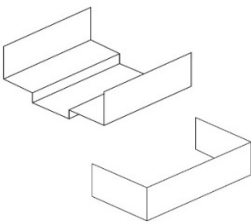
		PART NO.	LIST PRICE	
LEAD-LINED FRAMES				
	Lead-Lined Frame Clips	P0109	\$8	
LOCK STRIKE/FILLER PLATES				
	4-7/8" x 1-1/4" x .093 (ANSI 115.1 & 2)	CF000837	\$19	
	2-3/4" x 1-1/8" x .062 (ANSI 115.3)	CF000917	\$16	
	2-3/4" x 1-1/8" x .093 (Fed #161)	CF001097	\$16	
	2-1/4" x 15/16" x .062 (ANSI 115.4 Flush Bolt)	CF001177	\$16	
	H5 - Strike with Screws - 50 per package	CF001257	\$463	
	H5 - Filler with Screws - 50 per package	CF004637	\$264	
LOCK STRIKE REINFORCEMENTS				
	E1 Universal (ANSI 115.1 & 2), Box	E1NDCBUS	CF004307	\$14
	E1 Tab, .036 Offset, 12-24 Tap	E1SNDT	CF124436	\$8
	E2 Universal (ANSI 115.3), Box	E2NDCBUS	CF004067	\$14
	E3 Deadlock Tab, .060 Offset, 8-32 Tap (ANSI 115.5)	E3SNDT	CF006957	\$8
	E4 Tab (ANSI 115.3) - Same as E3		CF006957	\$8
	E4 Universal	E4NDSCBS	CF004067	\$14
MUD COVER FOR HINGE OR STRIKE REINFORCEMENT				
	E1 Universal without Tap Holes (ANSI 115.1 or 2)	E1NDCBUSNT	\$11	
	4-1/2" x 5" Hinges, 20 gauge	FH0005	\$8	
	Universal Cover Box 1-15/16" x 10-1/2" x 1" Deep	FS0003	\$42	
	Universal Cover Box 1-7/8" x 13" x 1-7/8" Deep with knockouts	FS0020	\$49	
PANIC EXIT DEVICE REINFORCEMENT				
	E5 Rim Vertical Rod — 1-3/4" x 10" x 12 gauge	E5VREDR	\$15	
	E8 Rim Exit — 1-1/4" x 8" x 12 gauge	E8REDR	\$15	
SPLICING REINFORCEMENTS				
	Standard Frame (8" x 12 gauge [Sleeve]) Specify Jamb Depth	P0155	\$43	
	Field Splice Bracket (3" x 12 gauge) Specify Jamb Depth	P0156	\$18	

*Additional charges may apply for welding

		PART NO.	LIST PRICE	
SPATS - STAINLESS STEEL				
	Hospital Type (Specify Jamb Depth)			
	Jamb Depth, 3" through 7" (6" High)	Each	P0157	\$197
	Jamb Depth, 7-1/8" through 12" (6" High)	Each		\$252
	Wrap-Around (Specify Jamb Depth)			
	Jamb Depth, 3" through 7" (6" High)	Each	P0158	\$264
	Jamb Depth 7-1/8" through 12" (6" High)	Each		\$331
SPREADER BAR REINFORCEMENT CHANNEL				
	Refer to Flush Stick (CCW 111) section of the catalog for ordering and pricing information.		See CCW 111	
THROAT FILLER				
	PVC Plastic/Self-Adhesive for Drywall Frames			
	50 pieces, 7'3" length	Per Carton	CF000427	\$1,025
STOP FILLER HEAD				
	D.E. G Profile		P0154	\$12
	(advise jamb depth)			

***Additional charges may apply for welding**

		PART NO.	LIST PRICE
"C" DRYWALL FRAMES			
CASED OPENING - COMPRESSION ANCHOR			
	Compression anchor, 2" Face Jambs	P0095	\$14
	"L" Type Stiffener - required with Compression Anchor on cased opening (Specify Jamb Depth)	P0093	\$7
DRYWALL FRAMES - COMPRESSION ANCHOR			
	Compression Anchor, 2" Face Jambs	P0026	\$14
	Compression Anchor, 1-1/2" - 1-3/4" Face Jambs	P0018	\$14
	Base Anchor, Weld-In Type (Specify Jamb Depth)	P0087	\$3
ADJUSTABLE MULTIPURPOSE ANCHOR			
	2" Face Flush or Drywall Profile Jamb Depths 4-3/8" to 6-3/4" (1/8" increments)	P0027	\$3
MULTIPURPOSE - SLIP-IN (SPECIFY JAMB DEPTH)			
	2" Face Flush or Drywall Profile Jamb Depth 4-3/4" through 9 3/4" (1/8" increments)	P0045	\$3
*Additional charges may apply for welding			

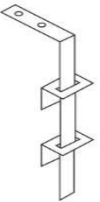
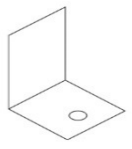
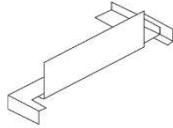
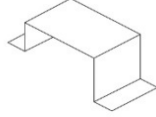
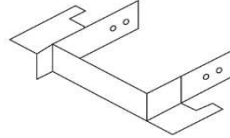
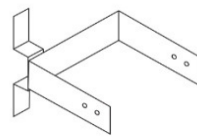
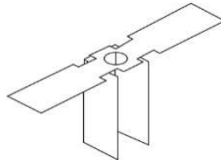
		PART NO.	LIST PRICE
"M" MASONRY FRAMES			
ADJUSTABLE CEILING STRUT			
	Adjustable Ceiling Strut, 1/4" x 1" x 36" Bar	Each	\$52
	Adjustable Ceiling Strut, Socket Reinforced	Each	\$9
	Adjustable Ceiling Strut, Wedges	Each	\$6
	Adjustable Ceiling Strut, Set (Set consists of 1 Bar, 2 Sockets, 2 Wedges)	Per Set	P0159
DOUBLE EGRESS (2) PIECES FOOT CLIP			
		P0081	\$5
DOUBLE EGRESS, STEEL STUD, CHANNEL TYPE, SLIP-IN			
	(Specify Jamb Depth and Face Dimension)	P0149	\$3
DOUBLE EGRESS, STEEL STUD, CHANNEL TYPE, WELD-IN			
	(Specify Jamb Depth and Face Dimension)	P0053	\$8
		Specify for jamb or head	
DOUBLE EGRESS, WOOD STUD, SLIP-IN			
	(Specify Jamb Depth, Face Dimension & Stud Size)	P0152	\$8
	(3-1/2" Stud)		
	(3-5/8" Stud)		
	(5-1/2" Stud)		
DOUBLE EGRESS, WOOD STUD, WELD-IN			
	(Specify Jamb Depth, Face Dimension & Stud Size)	P0148	\$8
	(3-1/2" Stud)	Specify for jamb or head	
	(3-5/8" Stud)		
	(5-1/2" Stud)		
EWA ANCHOR - SPECIFY SIZE			
	Jamb Depth up to 5-3/4" (P0070)	CF005476	\$3
	Jamb Depth up to 8-3/4" (P0070)	CF004896	\$3
	Bolts not included.		
*Additional charges may apply for welding			

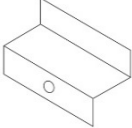
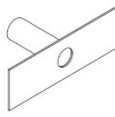
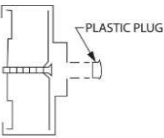
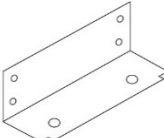
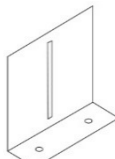
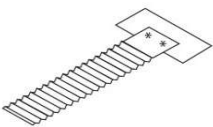
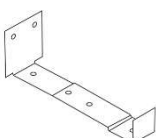
		PART NO.	LIST PRICE
EXISTING OPENING SPACING BRACKET ONLY			
	1/2" Diameter Hole	P0146	\$3
	(Specify Jamb Dimension)		
EXISTING OPENING 3/8" DIAMETER, PIPE SPACER ONLY			
	(Specify Jamb Dimension and Face Dimension)	P0044	\$9
	Bolts not included.		
EXISTING OPENING ANCHOR - CONCEALED WITH PLASTIC CAP			
	5-3/4" Jamb Depth 2" Face Only	Quantity 100	CF004557
	(Includes Caps, Bolt not included)		
	Plastic Cap Plug	Quantity 100	MS002600
FOOT CLIP, STANDARD			
	Standard	P0030	\$3
	Variable	P0171	\$3
	Mullion	P0261	\$3
	Double Egress	P0081	\$3
	(Specify Jamb Depth and Face Dimension)		
FOOT CLIP, ADJUSTABLE			
	(Specify Jamb Dimension)	P0078	\$11
MASONRY "T"			
	(Specify Jamb Depth and Face Dimension)	P0069	\$3
REMOVABLE MULLION BRACKET			
	(Specify Mullion Profile, Jamb Depth and Face)	P0090	\$21
*Additional charges may apply for welding			

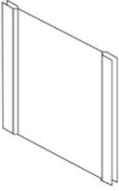
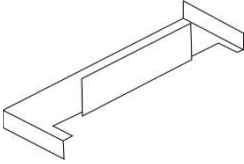
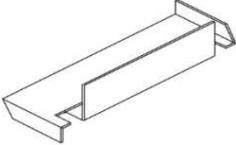
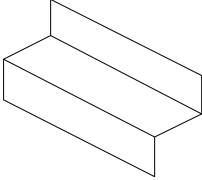
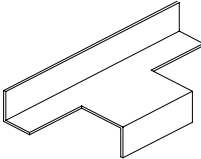
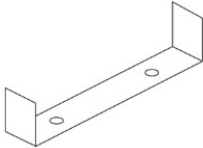
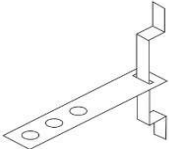
		PART NO.	LIST PRICE
SPLINE ANCHOR			
	(Specify Jamb Depth)	P0200	\$32
STEEL STUD, CHANNEL TYPE, SLIP-IN			
	(Specify Jamb Depth and Face Dimension)		
	1/2" Recess for Stud	P0149	\$3
STEEL STUD, CHANNEL TYPE, SLIP-IN, FLUSH TO RETURN			
	(Specify Jamb Depth and Face Dimension)		
	Flush to Frame Return	P92	\$3
STEEL STUD, CHANNEL TYPE, WELD-IN			
	1/2" recess for stud (specify jamb depth and face dimension)	P29	\$3
STEEL STUD, CHANNEL TYPE, WELD-IN, FLUSH TO RETURN			
	Flush to Frame Return (specify jamb depth and face dimension)	P405	\$3
STIRRUP ANCHORS MULLION			
	Mullion Stirrup	P0089	\$6
	(Specify Jamb Depth and Face Dimension)		
WELD-IN TYPE - MASONRY			
	Minimum stop width 1" for Stop Height 5/8" and less.	P0002	\$6
	Minimum stop width 2-1/8" for Stop Height greater than 5/8".		
*Additional charges may apply for welding			

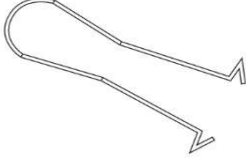
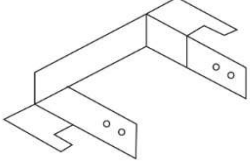
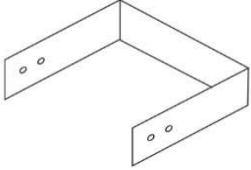
		PART NO.	LIST PRICE
WIRE MASONRY ANCHOR			
		P0098	\$3
WOOD STUD, SLIP-IN			
	(Specify Jamb Depth, Face Dimension & Stud Size)	P0152	\$3
	(3-1/2" Stud)		
	(3-5/8" Stud)		
	(5-1/2" Stud)		
	(5-5/8" Stud)		
WOOD STUD, WELD-IN			
	(Specify Jamb Depth, Face Dimension & Stud Size)	P0148	\$3
	(3-1/2")		
	(3-5/8")		
	(5-1/2")		
	(5-5/8")		
*Additional charges may apply for welding			

			PART NO.	LIST PRICE
ASPHALTIC BACK-COATING				
	Aerosol Spray Can	12 Cans Per Case	MS112409	\$833
	5 Gallon Can	Per Can	MS112565	\$353
DIES - FRAME CUTOUTS				
	Existing Wall Anchor Punch		MS000067	\$740
PRIMER (FIELD TOUCH-UPS)				
	Gray Aerosol Spray Primer (AirDry)	12 Per Case	MS002436	\$433
	Water Base Primer	Gallon	MS004127	\$151
	Standard Gray Primer (Air Dry)	Gallon Can	MS002444	\$151
	NOTE: Paint is shipped UPS or Federal Express only.			
PUNCH SETS FOR ROPER WHITNEY HAND PRESS				
	Hole and countersink 3/8" — E.W.A. bolt		MS004358	Contact Factory
	Hole and countersink #8 screw — Glass stop		MS004176	Contact Factory
	Roper Whitney Hand Press		MS000182	Contact Factory
*Additional charges may apply for welding				

		PART NO.	LIST PRICE
SCREWS AND BOLTS			
	No. 8 x 1/2" Pan Head	Per 100	MS002485 \$49
	No. 10 x 2-1/2" Pan Head	Per 100	MS002493 \$71
	No. 6 — 20 x 1-1/4" Oval Head Phillips "Tekes" Self-Drilling, Tapping Zinc-Plated (Door Window Kit #1-4, std. Screw)	Per 1000	MS002501 \$351
	No. 6 — 20 x 1-1/4" Oval Head Torx Security "Tekes Screw", Zinc-Plated (Door Window Kit #1-4, Security Screw)	Per 100	MS004291 \$198
	#8 x 1-1/2" type AB Pin-in-head Torx security screw, oval countersunk head, tapping screw, steel, zinc plated for Type 9 window kit (3/8", 9/16", and 13/16" pocket)	Each	MA0886 \$10
	#8 X 1-1/2" Oval Head Phillips "Tekes" Self-drilling, Tapping Zinc-Plated for Type 9 and 10 Window Kit (3/8", 9/16", 13/16" pockets)	Each	MA0784 \$10
	#8 x 1-3/4" type AB Pin-in-head Torx security screw, oval countersunk head, tapping screw, steel, zinc plated for Type 10 window kit (1-1/16" pocket)	Each	MA0887 \$10
	#8 X 1-3/4" Oval Head Phillips "Tekes" Self-Drilling, Tapping Zinc Plated for Type 10 Window Kit (1-1/16" pocket)	Each	MA0785 \$10
	No. 8 — 18 x 1-1/2" Oval Head Phillips "Tekes" Self-Drilling, Tapping Zinc-Plated (Frame Glass Stop Screw)	Per (1000)	MS002584 \$513
	No. 8 — 32 x 5/8" Machine Screw	Per (100)	MS002519 \$43
	No. 8 – 32 x 1-1/4" Oval Head Torx, self drilling Self Drilling Torx Driver (T-20 Bit)	Per (100) Each	MS006569 \$263 MS006627 \$48
	No. 10 — 24 x 1/2" Machine Screw	Per (100)	MS002527 \$43
	No. 12 — 24 Machine Screw	Per (100)	MS002535 \$43
	No. 1/4 Sex Bolts	Each	MS002550 \$11
	Flat-Head 3/8" x 6" Sleeved Wall Anchor Bolt (For UL Pipe Spacer Anchor)	Each	MS002568 \$11
	Flat-Head 3/8" x 4" Sleeved Wall Anchor Bolt	Each	MS002576 \$11
	Door Label Drive Screws	Per (1000)	MS000232 \$150
	1/4 - 20 x 3/4" Flathead Torx machine screws	Per (100)	MS004135 \$185
	1/4 - 20 x 1/2" Button head Torx machine screws	Per (100)	MS004184 \$161
	No. 6-20 x 3/4" button pin-in-head torx black oxide screw	Each	MS052548 \$8
TOUCH-UP PAINT (PRE-FINISH COLORS)			
(Air Dry) Specify Color Number (Door)	Per Gallon	MS004002 \$302	
(Frame)	Per Gallon	MS003004 \$302	
*Additional charges may apply for welding			

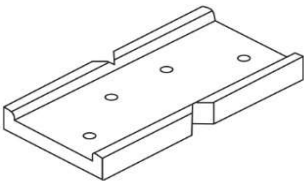
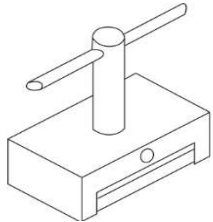
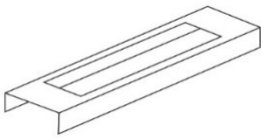
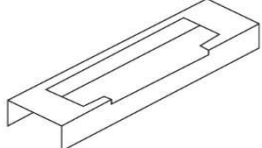
		PART NO.	LIST PRICE
DOOR HARDWARE CUT-OUT TEMPLATES			
HINGE DRILL FIXTURE			
	4-1/2" Hinge Drill Fixture — Replacement Door, TD 928 — 1/4" Backset	CD008932	\$555
	4-1/2" Hinge Drill Fixture — Replacement Door, TD 943 — 3/16" Backset	CD009192	\$555
	5" Hinge Drill Fixture — Replacement Door, TD 956 — 1/4" Backset	CD009272	\$555
LATCH BOLT			
	1-3/4 G2 - Latch Bolt Tab Weld Fixture	CD009012	\$772
LATCH FRONT			
	G2 - Gov't 161, Lock Front 1-3/4 Doors (2-1/4")	CD007372	\$81
	G3 - Mortise, Lock Front 1-3/4 Doors (8")	CD007452	\$81
	G1 - G2 Cylindrical Lock Face 1-3/4 (2-1/8" diameter)	CD008512	\$81
	H1 - Flush Bolt Lock Front 1-3/4 Doors (6-3/4")	CD007602	\$81
DEAD LOCK STRIKE			
	E3 - Dead Lock Strike (No Lip), 1-3/4 Doors (3-1/2")	CD007862	\$81
	E4 - Dead Lock Strike (No Lip), 1-3/4 Doors (2-3/4")	CD008022	\$81
MORTISE STRIKE			
	E1 - Mortise Strike, 1-3/4 Doors (4-7/8")	CD008102	\$81
	CYLINDER LOCK STRIKE		
	E2 - Cylinder Lock Strike, 1-3/4 Doors (2-3/4")	CD008362	\$81

*Additional charges may apply for welding

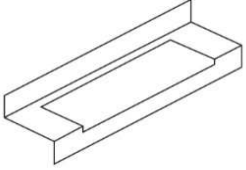
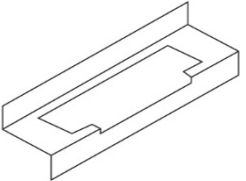
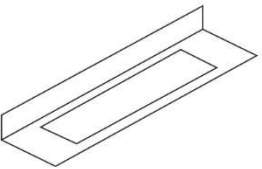
		PART NO.	LIST PRICE
FRAME HARDWARE CUT-OUT TEMPLATES			
HINGE			
	453 Hinge (4-1/2") 1 3/4" door frame	CF002997	\$81
	503 Hinge (5") 1 3/4" door frame	CF003077	\$81
MORTISE STRIKE			
	E1 — Mortise Strike, 1-3/4 Doors (4-7/8")	CF001907	\$81
	CYLINDER LOCK STRIKE		
	E2 — Cylinder Lock Strike, 1-3/4 Doors (2-3/4")	CF003987	\$81
STRIKE			
	E3 — Dead Lock Strike (No Lip), 1-3/4 Doors (3-1/2")	CF002327	\$81
	E4 — Dead Lock Strike (No Lip), 1-3/4 Doors (2-3/4")	CF002577	\$81
	H2 — Flush Bolt Strike, 1-3/4 Doors (2-1/4")	CF002737	\$81
	H5 — Reversible Flush Bolt, 1-3/4 Doors (3-7/8")	CF004717	\$81
*Additional charges may apply for welding			

DESCRIPTION	PAGE(S)
Bullet Resistant	
737S Series Doors	
Level 1-2 Doors	2-3
Level 3 Doors	4-5
Level 1-3 Frames	6-7
Level 4-8 Doors	8-9
Level 4-8 Frames	10-11
FRP - DISCONTINUED	
Lead Lined	
748 Series Doors	12-13
LLM Series Frames	
16 ga.	14-15
14 ga.	16-17
12 ga.	18-19
RF Shielding	
749 Series Doors	20
750 Series Doors	20
RM Series Frames	21
Stainless Steel	
707 Series Doors	22
747 Series Doors	22
SMM Series Frames	
16 ga.	23
14 ga.	23
12 ga.	23
Water Resistant	
780 Series Doors	24-25
787 Series Doors	26-27
WRM Series Frames	
16 ga.	28-29
14 ga.	30-31
12 ga.	32-33
Attack Resistant with Glass	
707 Series Doors	34-35
Attack Resistant Retrofit Kit and Glazing	36
Fire Rated	38-39
Forced Entry Bullet Resistant Opening	
859 Series Door	40
Frames	41
Flood Resistant Opening	
789 Series Door	42-43
14 ga.	44-45
12 ga.	46-47
Blast Resistant Opening	
867 Series Door	48
Blast Resistant Frame	49

2
737S Series Doors-Bullet Resistant Level 1-2

Bullet Resistant Door Prices

May, 2024



WIDTH	HEIGHT	16 ga	14 ga
20, 24, 26, 28, 210, 30	68	FACTORY QUOTE ONLY at specialtypricing.curries@assaabloy.com For faster quote turnaround, please use the QQF (Quick Quote Forms) located on Connect	
34, 36	68		
38, 310, 40	68		
20, 24, 26, 28, 210, 30	70		
34, 36	70		
38, 310, 40	70		
20, 24, 26, 28, 210, 30	72		
34, 36	72		
38, 310, 40	72		
30	80		
34, 36	80		
38, 310, 40	80		
30	90		
34, 36	90		
38, 310, 40	90		
30	100		
34, 36	100		
38, 310, 40	100		

STANDARD DESCRIPTION

Proprietary bullet resistant core with an "A" edge bevel and exposed seam "S" edge are standard.
 1 7/8" thickness for 1 15/16" frame rabbet
 U.L. 752 bullet resistant label level 1 and level 2 doors must be ordered as an assembly with factory welded M12 series frame.

EDGE BEVELS AVAILABLE

Factory Quoted

A standard (1/8" in 2" lock edge-square hinge edge)

"B" specify (square both edges)

"G" specify (1/8" in 2" bevel both edges)

Galvanneal Steel (A60)

Factory Quoted

- a) 68 HEIGHT
- b) 70 HEIGHT
- c) 72 HEIGHT
- d) 80 HEIGHT
- e) 90 HEIGHT
- f) 100 HEIGHT

Galvanized (G90) includes epoxy primer

Factory Quoted

- a) 68 HEIGHT
- b) 70 HEIGHT
- c) 72 HEIGHT
- d) 80 HEIGHT
- e) 90 HEIGHT
- f) 100 HEIGHT

OVERSIZED DOOR OPTIONS

Doors over 8' high are factory crated for protection in transit

NON STANDARD SIZE DOORS

Factory Quoted

NOTE: Doors over 4' 10" not available. Only bullet resistant hardware may be used.

Contact factory for complete list of approved hardware. Crating is included in the price of doors over 8' high.

Polyurethane slab core

Factory Quoted

"N" seamless edge filled

Factory Quoted

"T" Continuous wire welded

Factory Quoted

Visual ID tag

Factory Quoted

4
737 Series Doors - Bullet Resistant Level 3

Bullet Resistant Door Prices

May, 2024



WIDTH	HEIGHT	12 ga
20, 24, 26, 28, 210, 30	68	<p align="center">FACTORY QUOTE ONLY at specialtypricing.curries@assaabloy.com For faster quote turnaround, please use the QQF (Quick Quote Forms) located on Connect</p>
34, 36	68	
38, 310, 40	68	
20, 24, 26, 28, 210, 30	70	
34, 36	70	
38, 310, 40	70	
20, 24, 26, 28, 210, 30	72	
34, 36	72	
38, 310, 40	72	
30	80	
34, 36	80	
38, 310, 40	80	
30	90	
34, 36	90	
38, 310, 40	90	
30	100	
34, 36	100	
38, 310, 40	100	

NON STANDARD SIZE DOORS

Factory Quoted

NOTE: Only bullet resistant hardware may be used. Contact factory for complete list of approved hardware. Crating is included in the price of doors over 8' High.

**NOTE: This product is manufactured offsite and ships separately
 Call to verify lead-times, freight cost, and ship schedule**

STANDARD DESCRIPTION

Proprietary core with an "A" edge bevel and continuous welded "T" edge are standard

1 3/4" thickness for 1 15/16" frame rabbet

U.L. 752 bullet resistant doors must be ordered as an assembly with factory welded Level 3 series frame required.

EDGE BEVELS AVAILABLE

Factory Quoted

A standard (1/8" in 2" lock edge-square hinge edge)

"B" specify (square both edges)

"G" specify (1/8" in 2" bevel both edges)

NOTE: Refer to Engineered Door Section for other available edge bevels

Galvanneal Steel (A60)

Factory Quoted

- a) 68 HEIGHT
- b) 70 HEIGHT
- c) 72 HEIGHT
- d) 80 HEIGHT
- e) 90 HEIGHT
- f) 100 HEIGHT

Galvanized (G90) includes epoxy primer

Factory Quoted

- a) 68 HEIGHT
- b) 70 HEIGHT
- c) 72 HEIGHT
- d) 80 HEIGHT
- e) 90 HEIGHT
- f) 100 HEIGHT

LISTED FIRE LABEL DOORS

Factory Quoted

Label door restrictions per gauge and size can be determined in the current CURRIES product brochure.

Underwriters Laboratories B and C
 20 minute U.L.

Mortise lock or mortise exit device

Refer to the Tech data manual for limitations

737 Series Doors - Bullet Resistant Level 3 Bullet Resistant Door Prices

May, 2024

EXTRAS		EXTRAS	
CAPS — top or bottom	Factory Quoted	LOCK PREPARATIONS CONTINUED	Factory Quoted
Steel installed flush (with screws per cap)		Mortise lock 1 3/4" door escutcheon trim	G3
CLOSER	Factory Quoted	Mortise lock 1 3/4" door sectional trim	G3A*
Surface mounted, reinforcement only		Hotel and master ring cylinder functions	
HINGE PREPARATIONS	Factory Quoted	Mortise lock edge only preparation	G3AEO
4 1/2" standard or heavyweight		Mortise lock reinforce only	G3ARO
5" Hinge standard or heavyweight		Mortise panic exit	G12*
1 1/2 pair up to and including 7'6"		Rim panic reinforce only	G11
2 pair over 7'6" to 10'0"		Rim panic reinforce with function holes	G11*
Anchor hinge set		Rim vertical rod reinforce only	G11A
(e.g. McKinney TA792) No drill, no tap		Rim vertical rod with function holes	G11A*
(e.g. McKinney TA793)		LOUVERS	Not Available
Continuous hinge		STRIKES	Factory Quoted
FLUSH BOLTS OR SURFACE BOLTS	Factory Quoted	Electric Strike	E9*
Top and bottom flush bolt ANSI A115.4 H1		Electric raceway	
(when used without astragal or with flat bar astragal)		*Advise of manufacturer and function of hardware. Hardware function holes do not include trim mounting holes	
Top and bottom surface bolt reinforced only SB		UNDERCUTS	Factory Quoted
ASTRAGAL	Factory Quoted	1 3/4" doors-5/8" standard, 3/8", 3/4" available.	
Flat astragal		All other undercuts per door	
Alternate to astragal; removable mullion by frame manufacturer required-see frames		VISION KITS	Factory Quoted
LOCK PREPARATIONS	Factory Quoted	NON FIRE RATED	
Cylindrical lock 1-3/4" door 161 G2		FV	
Cylindrical lock 1-3/4" door lever trim G2B* (Universal lever trim prep.)		FNV	
Deadlock 1 3/4" door tubular 181 G16		HG	
Deadlock 1 3/4" door mortise 190 G17		FG	

BR3 level 1-3 12 Gauge Bullet Resistant Frames

Bullet Resistant Frame Prices

May, 2024

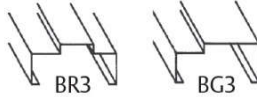

	WIDTH	HEIGHT	3 5/8 THRU 6	6-1/8 THRU 7-7/8	8 THRU 9-7/8	10 THRU 11-7/8	12 THRU 14	
SINGLES	1'6" THRU 3'0"	6'8"	FACTORY QUOTE ONLY at specialtypricing.curries@assaabloy.com For faster quote turnaround, please use the QQF (Quick Quote Forms) located on Connect					
		7'						
		7'2"						
		8'						
		9'						
	3' + THRU 4'0"	10'						
		6'8"						
		7'						
		7'2"						
		8'						
DOUBLES	4' + THRU 6'0"	9'						
		10'						
		6'8"						
		7'						
		7'2"						
	6' + THRU 8'0"	8'						
		9'						
		10'						
		6'8"						
		7'						

GENERAL INFORMATION

CURRIES BR3 series frames are available double rabbet (equal or unequal) or BG3 single rabbet profile. Prices will reflect hardware preparations are for 1 3/4" doors. Refer to CURRIES Architectural Technical Data Manual for standard details and limitations.

NOTE: 5-3/4" jamb depth frames have 1/2" minimum back bend. 7/16" N.A.

2" face frames are standard. 1", 1 1/4" and 1 1/2", & 1 3/4" face frames are priced the same as 2" face at no extra charge.

Jamb depth ranges are listed above each column. 1/8" increment jamb depths (all ranges 3 1/2" thru 14") are available.

ANCHORS - foot clips are welded in place 3 per jamb up to 7'6" and 4 per jamb over 7'6". Complete anchor information is listed in the Engineered Frame Section.

Welding charge only per anchor **Factory Quoted**
(Add for appropriate anchor)

EXTRAS
BUNDLING AND TAGGING FRAMES **Factory Quoted**

Frame Order Code 3F, 3FH, 3FV, 2F, SL, BL, and 4F
Welded Frames

BR3 Level 1-3 12 Gauge Bullet Resistant Frames

Bullet Resistant Frame Prices

May, 2024

EXTRAS		EXTRAS	
DUTCH DOOR FRAME	Factory Quoted	HARDWARE PREPARATIONS	
Four (4") INCH FACE HEADS (4-5/8" MIN) JAMB DEPTH	Factory Quoted	CLOSER PREPARATIONS	Factory Quoted
Single including 4'0"		Regular arm	E10
Pairs over 4'0"		Parallel arm	E11
		Half Sleeve	E18
		Full Sleeve	E17
GALVANNEAL (A60) FRAME ADDS	Factory Quoted	FLUSH BOLTS	Factory Quoted
Price per 3 sided frame		Standard ANSI 115.4	H2
		Reversible (strike plate included)	H5
		Reinforce only	H1
GALVANIZED (G-90)	Factory Quoted	HINGE PREPARATIONS	Factory Quoted
Price per 3 Sided frame		3 1/2" 1 pair or 1 1/2 pair	
		4 1/2" standard or heavyweight	
FIRE FRAME LABELS	Factory Quoted	1 1/2 pair up to and including 7'6"	
UNDERWRITERS LABORATORIES		2 pair over 7'6" to 8'0"	
Single Frame		5" standard or heavyweight	
Double frame		Full surface mounted continuous hinge reinforcement	
		High frequency reinforcement strap support	
		HOLDERS	Factory Quoted
		Overhead concealed	
		PIVOTS	Factory Quoted
		Top and bottom set single acting	
		Intermediate pivot single acting	
		PANIC EXIT REINFORCING	Factory Quoted
		Rim type	E8
		Rim vertical rod surface mounted strike	E5
		Vertical rod mortise strike in head - Each	G20
		REMOVABLE MULLION	Factory Quoted
		For pairs of doors; alternate to astragal on do	
		STRIKES	Factory Quoted
		4 7/8" ANSI lipped strike 1 3/4" door	E1
		2 3/4" ANSI lipped strike 1 3/4" door	E2
		3 1/2" ANSI deadlock strike 1 3/4" door	E3
		2 3/4" ANSI deadlock strike 1 3/4" door	E4
		Electric strike frame	E9
		(includes cover box with knockout)	
		SURFACE BOLTS	Factory Quoted
		Reinforcement only	

8
737 Series Doors-Bullet Resistant Level 4-8



Bullet Resistant Door Prices

May, 2024

WIDTH	HEIGHT	14 ga
20, 24, 26, 28, 210, 30	68	<p align="center">FACTORY QUOTE ONLY at specialtypricing.curries@assaabloy.com For faster quote turnaround, please use the QQF (Quick Quote Forms) located on Connect</p>
34, 36	68	
38, 310, 40	68	
20, 24, 26, 28, 210, 30	70	
34, 36	70	
38, 310, 40	70	
20, 24, 26, 28, 210, 30	72	
34, 36	72	
38, 310, 40	72	
30	80	
34, 36	80	
38, 310, 40	80	
30	90	
34, 36	90	
38, 310, 40	90	
30	100	
34, 36	100	
38, 310, 40	100	

NOTE: This product is manufactured offsite and ships separately
Call to verify lead-times, freight cost, and ship schedule

STANDARD DESCRIPTION

Proprietary core with an "A" edge bevel and continuous welded "T" edge are standard.
 1 3/4" thick door

EDGE BEVELS AVAILABLE

Factory Quoted

A standard (1/8" in 2" lock edge-square hinge edge)
 "B" specify (square both edges)
 "G" specify (1/8" in 2" bevel both edges)

Galvanneal Steel (A60)

Factory Quoted

- a) 68 HEIGHT
- b) 70 HEIGHT
- c) 72 HEIGHT
- d) 80 HEIGHT
- e) 90 HEIGHT
- f) 100 HEIGHT

Galvanized (G90) includes epoxy primer

Factory Quoted

- a) 68 HEIGHT
- b) 70 HEIGHT
- c) 72 HEIGHT
- d) 80 HEIGHT
- e) 90 HEIGHT
- f) 100 HEIGHT

NON STANDARD SIZE DOORS

Factory Quoted

LISTED FIRE LABEL DOORS

Call for availability

737 Series Doors - Bullet Resistant Level 4-8
Bullet Resistant Door Prices

May, 2024

	EXTRAS	Factory Quoted
CAPS - top or bottom		
Steel installed flush (with screws per cap)		
 CLOSER - FACTORY QUOTED		
Surface mounted, reinforcement only		
 FLUSH BOLTS OR SURFACE BOLTS		Factory Quoted
Top and bottom flush bolt ANSI A115.4		H1
(when used without astragal or with flat bar astragal)		
Top and bottom surface bolt reinforced only		SB
 HINGE PREPARATIONS - FACTORY QUOTED		
Continuous hinge preparation (mounting holes field drilled)		
Concealed mounting		
Surface mounting		
 ASTRAGAL		Not Available
Pair of doors requires removable mullion by frame manufacturer see frames		
 LOCK PREPARATIONS		Factory Quoted
Cylindrical lock 1-3/4" door 161		G2
Cylindrical lock 1-3/4" door lever trim (Universal lever trim prep)		G2B*
Deadlock 1 3/4" door tubular 181		G16
Deadlock 1 3/4" door mortise 190		G17
Interconnected lock		G25

	EXTRAS	Factory Quoted
LOCK PREPARATIONS CONTINUED		Factory Quoted
Mortise lock 1 3/4" door escutcheon trim		G3
Mortise lock 1 3/4" door sectional trim		G3A*
Hotel and master ring cylinder functions		
Mortise lock edge only preparation		G3AEO
Mortise lock reinforce only		G3ARO
Mortise panic exit		G12*
Rim panic reinforce only		G11
Rim panic reinforce with function holes		G11*
Rim vertical rod reinforce only		G11A
Rim vertical rod with function holes		G11A*
 STRIKES		Factory Quoted
4 7/8" ANSI lipped strike 1 3/4" door		E1
2 3/4" ANSI lipped strike 1 3/4"		E2
3 1/2" ANSI deadlock strike		E3
2 3/4" ANSI deadlock strike		E4
Electric strike		E9
Electric raceway		
Open back strike non label door		*
*Advise of manufacturer and function of hardware. Hardware function holes do not include trim mounting holes.		
 UNDERCUTS		Factory Quoted
1 3/4" doors-5/8" standard, 3/8", 3/4" available.		
All other undercuts per door		
 VISION KITS		Factory Quoted
Vision kits installed- glass included		
FV		
FNV		
HG		
FG		

10
BR4 level 4-8 14 Gauge Bullet Resistant Frames
Bullet Resistant Frame Prices



May, 2024

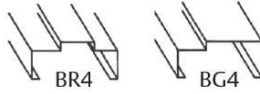

	WIDTH	HEIGHT	3 5/8 THRU 6	6-1/8 THRU 7-7/8	8 THRU 9-7/8	10 THRU 11-7/8	12 THRU 14
SINGLES	1'6" THRU 3'0"	6'8"	FACTORY QUOTE ONLY at specialtypricing.curries@assaabloy.com For faster quote turnaround, please use the QQF (Quick Quote Forms) located on Connect				
		7'					
		7'2"					
		8'					
		9'					
	3' + THRU 4'0"	10'					
		6'8"					
		7'					
		7'2"					
		8'					
DOUBLES	4' + THRU 6'0"	9'					
		10'					
		6'8"					
		7'					
		7'2"					
	6' + THRU 8'0"	8'					
		9'					
		10'					
		6'8"					
		7'					

GENERAL INFORMATION

CURRIES BR4 series frames are available double rabbet (equal or unequal) or BG4 single rabbet profile. Prices will reflect hardware preparations for 1 3/4" doors. Refer to CURRIES Architectural Technical Data Manual for standard details and limitations.

NOTE: 5-3/4" jamb depth frames have 1/2" minimum back bend. 7/16" N.A.

2" face frames are standard. 1", 1 1/4" and 1 1/2", & 1 3/4" face frames are priced the same as 2" face at no extra charge.

Jamb depth ranges are listed above each column. 1/8" increment jamb depths (all ranges 3 1/2" thru 14") are available.

ANCHORS - foot clips are welded in place 3 per jamb up to 7'6" and 4 per jamb over 7'6". Complete anchor information is listed in the Engineered Frame Section.

Welding charge only per anchor **Factory Quoted**
 (Add for appropriate anchor)

EXTRAS

BUNDLING AND TAGGING FRAMES **Factory Quoted**

Frame Order Code 3F, 3FH, 3FV, 2F, SL, BL, and 4F
 Welded Frames

**NOTE: This product is manufactured offsite and ships separately
 Call to verify lead-times, freight cost, and ship schedule**

BR4 Level 4-8 14 Gauge Bullet Resistant Frames

Bullet Resistant Frame Prices

May, 2024

EXTRAS		EXTRAS	
DUTCH DOOR FRAME	Factory Quoted	HARDWARE PREPARATIONS	
Four (4") INCH FACE HEADS (4-5/8" MIN) JAMB DEPTH	Factory Quoted	CLOSER PREPARATIONS	Factory Quoted
Single including 4'0"		Regular arm	E10
Pairs over 4'0"		Parallel arm	E11
		Half Sleeve	E18
		Full Sleeve	E17
GALVANNEAL (A60) FRAME ADDS	Factory Quoted	FLUSH BOLTS	Factory Quoted
Price per 3 sided frame		Standard ANSI 115.4	H2
		Reversible (strike plate included)	H5
		Reinforce only	H1
GALVANIZED (G-90)	Factory Quoted	HINGE PREPARATIONS	Factory Quoted
Price per 3 Sided frame		Full surface mounted continuous hinge reinforcement	
FIRE FRAME LABELS	Call for availability	HOLDERS	Factory Quoted
		Overhead concealed	
		PIVOTS	Factory Quoted
		Top and bottom set single acting	
		Intermediate pivot single acting	
		PANIC EXIT REINFORCING	Factory Quoted
		Rim type	E8
		Rim vertical rod surface mounted strike	E5
		Vertical rod mortise strike in head - Each	G20
		REMOVABLE MULLION	Factory Quoted
		For pairs of doors; alternate to astragal on doors	
		STRIKES	Factory Quoted
		4 7/8" ANSI lipped strike 1 3/4" door	E1
		2 3/4" ANSI lipped strike 1 3/4" door	E2
		3 1/2" ANSI deadlock strike 1 3/4" door	E3
		2 3/4" ANSI deadlock strike 1 3/4" door	E4
		Electric strike frame	E9
		(includes cover box with knockout)	
		SURFACE BOLTS	Factory Quoted
		Reinforcement only	

748 Series Doors-Lead Lined Lead Lined Door Prices

May, 2024



QUOTE WILL INCLUDE 1/32" LEAD

WIDTH	HEIGHT	18 GA	16 GA	14 GA	12 GA
20, 24, 26, 28, 210, 30	68	FACTORY QUOTE ONLY at specialtypricing.curries@assaabloy.com For faster quote turnaround, please use the QQF (Quick Quote Forms) located on Connect			
34, 36	68				
38, 310, 40	68				
20, 24, 26, 28, 210, 30	70				
34, 36	70				
38, 310, 40	70				
20, 24, 26, 28, 210, 30	72				
34, 36	72				
38, 310, 40	72				
30	80				
34, 36	80				
38, 310, 40	80				
30	90				
34, 36	90				
38, 310, 40	90				
30	100				
34, 36	100				
38, 310, 40	100				

NON STANDARD SIZE DOORS

Factory Quoted

LISTED FIRE LABEL DOORS

Label door restrictions per gauge and size can be determined in the current CURRIES product brochure.

**NOTE: This product is manufactured offsite and ships separately
Call to verify lead-times, freight cost, and ship schedule**

STANDARD DESCRIPTION

Vertically welded steel stiffened lead lined core with an "A" bevel and continuous welded "T" edge is standard
1 3/4" thick door
4'0" x 10'0" maximum size door leaf

EDGE BEVELS AVAILABLE

Factory Quoted

A standard (1/8" in 2" lock edge-square hinge edge)

"B" specify (square both edges)

"G" specify (1/8" in 2" bevel both edges)

Galvanneal Steel (A60)

Factory Quoted

- a) 68 HEIGHT
- b) 70 HEIGHT
- c) 72 HEIGHT
- d) 80 HEIGHT
- e) 90 HEIGHT
- f) 100 HEIGHT

Galvanized (G90) includes epoxy primer

Factory Quoted

- a) 68 HEIGHT
- b) 70 HEIGHT
- c) 72 HEIGHT
- d) 80 HEIGHT
- e) 90 HEIGHT
- f) 100 HEIGHT

Underwriters Laboratories
20 minute U.L.

B and C **Factory Quoted**
Factory Quoted

LEAD THICKNESS

Factory Quoted

1/16" Lead
1/8" Lead
3/16" Lead
1/4" Lead
For alternate thicknesses, contact manufacturer

748 Series Doors -Lead Lined Lead Lined Door Prices

May, 2024

	EXTRAS			EXTRAS	
ASTRAGALS		Factory Quoted	LOCK PREPARATIONS CONTINUED		Factory Quoted
Flat astragal shipped loose (pair only)			Mortise lock 1 3/4" door escutcheon trim	G3	
CAPS — top or bottom		Factory Quoted	Mortise lock 1 3/4" door sectional trim	G3A*	
Steel installed flush (with screws per cap)			Hotel and master ring cylinder functions		
CLOSER		Factory Quoted	Mortise lock edge only preparation	G3AEO	
Surface mounted, reinforcement only			Mortise lock reinforce only	G3ARO	
Concealed or semi-concealed			Mortise panic exit	G12*	
FLUSH BOLTS OR SURFACE BOLTS		Factory Quoted	Rim panic reinforce only	G11	
Top and bottom flush bolt ANSI A115.4	H1		Rim panic reinforce with function holes	G11*	
(when used without astragal or with flat bar astragal)			Rim vertical rod reinforce only	G11A	
Top and bottom surface bolt reinforced only	SB		Rim vertical rod with function holes	G11A*	
HINGE PREPARATIONS		Factory Quoted	Concealed vertical rods	G12A*	
4 1/2" standard or heavyweight			STRIKES		Factory Quoted
5" Hinge standard or heavyweight			4 7/8" ANSI lipped strike 1 3/4" door	E1	
1 1/2 pair up to and including 7'6"			2 3/4" ANSI lipped strike 1 3/4" door	E2	
2 pair over 7'6" to 10'0"			3 1/2" ANSI deadlock strike	E3	
Anchor hinge set			2 3/4" ANSI deadlock strike	E4	
(e.g. McKinney TA792) No drill, no tap			Electric strike	E9*	
(e.g. McKinney TA793)			Electric raceway		
Continuous hinge preparation (mounting holes field drilled)			Open back strike non label door	*	
Concealed mounting					
(e.g. McKinney - 11, 24)					
Surface mounting					
(e.g. McKinney-21, 53)					
LOCK PREPARATIONS		Factory Quoted	UNDERCUTS		Factory Quoted
Cylindrical lock 1-3/4" door 161	G2		1 3/4" doors-5/8" standard, 3/8", 3/4" available.		
Cylindrical lock 1-3/4" door lever trim	G2B*		All other undercuts per door		
(Universal lever trim prep)			VISION KITS		Factory Quoted
Deadlock 1 3/4" door tubular 181	G16		Vision kits installed- glass by others (specify glass thickness)		
Deadlock 1 3/4" door mortise 190	G17		1/4" thick glass standard		
Interconnected lock	G25		FV		
			FNV		
			HG		
			FG		
			Add for other glass thickness up to 1"		

*Advise of manufacturer and function of hardware.
Hardware function holes do not include trim mounting holes.

LLM Series Frames - 16 Ga. Lead Lined 1/32"

Lead Lined Frame Prices

May, 2024

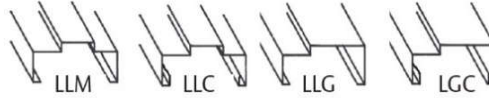

	WIDTH	HEIGHT	3 1/2 THRU 6	6-1/8 THRU 7-7/8	8 THRU 9-7/8	10 THRU 11-7/8	12 THRU 14	
SINGLES	1'6" THRU 3'0"	6'8"	FACTORY QUOTE ONLY at specialtypricing.curries@assaabloy.com For faster quote turnaround, please use the QQF (Quick Quote Forms) located on Connect					
		7'						
		7'2"						
		8'						
		9'						
	3' + THRU 4'0"	10'						
		6'8"						
		7'						
		7'2"						
		8'						
DOUBLES	4' + THRU 6'0"	9'						
		10'						
		6'8"						
		7'						
		7'2"						
	6' + THRU 8'0"	8'						
		9'						
		10'						
		6'8"						
		7'						

GENERAL INFORMATION

CURRIES LLM series frames are available double rabbet equal or unequal, or single rabbet profile. Prices will reflect hardware preparations for 1 3/4" doors. Refer to CURRIES Architectural Technical Data Manual for standard details and limitations.

NOTE: 5-3/4" jamb depth frames have 1/2" minimum back bend. 7/16" N.A.

2" face frames are standard. 1", 1 1/4", 1 1/2", & 1 3/4" face frames are priced the same as 2" face at no extra charge.

Jamb depth ranges are listed above each column. 1/8" increment jamb depths (all ranges 3 1/2" thru 14") are available.

ANCHORS - foot clips are welded in place
 Standard loose jamb anchors are included; 3 per jamb up to 7'6" and 4 per jamb over 7'6". Complete anchor information is listed in the Engineered Frame Section.

Welding charge only per anchor
 (Add for appropriate anchor)

Factory Quoted

**NOTE: This product is manufactured offsite and ships separately
 Call to verify lead-times, freight cost, and ship schedule**

EXTRAS

BUNDLING AND TAGGING FRAMES

Frame Order Code 3F, 3FH, 3FV, 2F, SL, BL, and 4F
 Welded Frames

Factory Quoted

LEAD THICKNESS

1/16" Lead
 1/8" Lead
 3/16" Lead
 1/4" Lead
 Alternate thicknesses may be available

Factory Quoted

LLM Series Frames-16 Ga Lead Lined 1/32" Lead Lined Frame Prices

May, 2024

EXTRAS		EXTRAS
DUTCH DOOR FRAME	Factory Quoted	HARDWARE PREPARATIONS
		CLOSER PREPARATIONS
		Concealed closer
Four (4") INCH FACE HEADS (4-5/8" MIN) JAMB DEPTH	Factory Quoted	Regular arm
Single including 4'0"		E10
Pairs over 4'0"		Parallel arm
		E11
		Half Sleeve
		E18
		Full Sleeve
		E17
GALVANNEAL (A60) FRAME ADDS	Factory Quoted	FLUSH BOLTS
Price per 3 sided frame		Factory Quoted
		Standard ANSI 115.4
		H2
		Reversible (strike plate included)
		H5
GALVANIZED (G-90)	Factory Quoted	Reinforce only
Price per 3 Sided frame		H1
		HINGE PREPARATIONS
		Factory Quoted
FIRE FRAME LABELS		3 1/2" 1 pair or 1 1/2 pair
UNDERWRITERS LABORATORIES	Factory Quoted	4 1/2" standard or heavyweight
Single Frame		1 1/2 pair up to and including 7'6"
Double frame		2 pair over 7'6" to 8'0"
		5" standard or heavyweight
		Full surface mounted continuous hinge reinforcement
		High frequency reinforcement strap support
		Per hinge
		HOLDERS
		Factory Quoted
		Overhead concealed
		Overhead stop and holder surface mounted 14 ga
		PIVOTS
		Factory Quoted
		Top and bottom set single acting
		Intermediate pivot single acting
		PANIC EXIT REINFORCING
		Factory Quoted
		Rim type
		E8
		Rim vertical rod surface mounted strike
		E5
		Vertical rod mortise strike in head - Each
		G20
		STRIKES
		Factory Quoted
		4 7/8" ANSI lipped strike 1 3/4" door
		E1
		2 3/4" ANSI lipped strike 1 3/8" or 1 3/4" door
		E2
		3 1/2" ANSI deadlock strike 1 3/8" or 1 3/4" c
		E3
		2 3/4" ANSI deadlock strike 1 3/8" or 1 3/4" c
		E4
		Electric strike frame
		E9
		(includes cover box with knockout)
		SURFACE BOLTS
		Factory Quoted
		Reinforcement only

LLM Series Frames - 14 Ga. Lead Lined 1/32"

Lead Lined Frame Prices

May, 2024

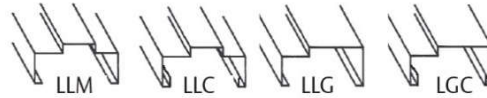

	WIDTH	HEIGHT	3 1/2 THRU 6	6-1/8 THRU 7-7/8	8 THRU 9-7/8	10 THRU 11-7/8	12 THRU 14
SINGLES	1'6" THRU 3'0"	6'8"	FACTORY QUOTE ONLY at specialtypricing.curries@assaabloy.com For faster quote turnaround, please use the QQF (Quick Quote Forms) located on Connect				
		7'					
		7'2"					
		8'					
		9'					
	3' + THRU 4'0"	10'					
		6'8"					
		7'					
		7'2"					
		8'					
DOUBLES	4' + THRU 6'0"	9'					
		10'					
		6'8"					
		7'					
		7'2"					
	6' + THRU 8'0"	8'					
		9'					
		10'					
		6'8"					
		7'					

GENERAL INFORMATION

CURRIES LLM series frames are available double rabbet equal or unequal, or single rabbet profile. Prices will reflect hardware preparations for 1 3/4" doors. Refer to CURRIES Architectural Technical Data Manual for standard details and limitations.

NOTE: 5-3/4" jamb depth frames have 1/2" minimum back bend. 7/16" N.A.

2" face frames are standard. 1", 1 1/4", 1 1/2", & 1 3/4" face frames are available.

Jamb depth ranges are listed above each column. 1/8" increment jamb depths (all ranges 3 1/2" thru 14") are available.

ANCHORS - foot clips are welded in place
 Standard loose jamb anchors are included; 3 per jamb up to 7'6" and 4 per jamb over 7'6". Complete anchor information is listed in the Engineered Frame Section.

Welding charge only per anchor
 (Add for appropriate anchor)

Factory Quoted

NOTE: This product is manufactured offsite and ships separately
 Call to verify lead-times, freight cost, and ship schedule

EXTRAS

BUNDLING AND TAGGING FRAMES

Frame Order Code 3F, 3FH, 3FV, 2F, SL, BL, and 4F
 Welded Frames

Factory Quoted

LEAD THICKNESS

- 1/16" Lead
- 1/8" Lead
- 3/16" Lead
- 1/4" Lead

Alternate thicknesses may be available

Factory Quoted

LLM Series Frames-14 Ga Lead Lined 1/32" Lead Lined Frame Prices

May, 2024

EXTRAS		EXTRAS	
DUTCH DOOR FRAME	Factory Quoted	HARDWARE PREPARATIONS	
		CLOSER PREPARATIONS	Factory Quoted
Four (4") INCH FACE HEADS (4-5/8" MIN) JAME	Factory Quoted	Concealed closer	
Single including 4'0"		Regular arm	E10
Pairs over 4'0"		Parallel arm	E11
		Half Sleeve	E18
		Full Sleeve	E17
GALVANNEAL (A60) FRAME ADDS	Factory Quoted	FLUSH BOLTS	Factory Quoted
Price per 3 sided frame		Standard ANSI 115.4	H2
		Reversible (strike plate included)	H5
GALVANIZED (G-90)	Factory Quoted	Reinforce only	H1
Price per 3 Sided frame			Factory Quoted
FIRE FRAME LABELS		HINGE PREPARATIONS	
UNDERWRITERS LABORATORIES	Factory Quoted	3 1/2" 1 pair or 1 1/2 pair	
Single Frame		4 1/2" standard or heavyweight	
Double frame		1 1/2 pair up to and including 7'6"	
		2 pair over 7'6" to 8'0"	
		5" standard or heavyweight	
		Full surface mounted continuous hinge reinforcement	
		High frequency reinforcement strap support	
		Per hinge	
		HOLDERS	Factory Quoted
		Overhead concealed	
		Overhead stop and holder surface mounted 14 ga	
		PIVOTS	Factory Quoted
		Top and bottom set single acting	
		Intermediate pivot single acting	
		PANIC EXIT REINFORCING	Factory Quoted
		Rim type	E8
		Rim vertical rod surface mounted strike	E5
		Vertical rod mortise strike in head - Each	G20
		STRIKES	Factory Quoted
		4 7/8" ANSI lipped strike 1 3/4" door	E1
		2 3/4" ANSI lipped strike 1 3/4" door	E2
		3 1/2" ANSI deadlock strike 1 3/4" door	E3
		2 3/4" ANSI deadlock strike 1 3/4" door	E4
		Electric strike frame	E9
		(includes cover box with knockout)	
		SURFACE BOLTS	Factory Quoted
		Reinforcement only	

LLM Series Frames - 12 Ga. Lead Lined 1/32"

Lead Lined Frame Prices

May, 2024

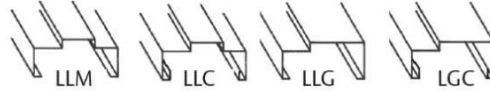

	WIDTH	HEIGHT	3 1/2 THRU 6	6-1/8 THRU 7-7/8	8 THRU 9-7/8	10 THRU 11-7/8	12 THRU 14
SINGLES	1'6" THRU 3'0"	6'8"	<p>FACTORY QUOTE ONLY at specialtypricing.curries@assaabloy.com For faster quote turnaround, please use the QQF (Quick Quote Forms) located on Connect</p>				
		7'					
		7'2"					
		8'					
		9'					
	3' + THRU 4'0"	6'8"					
		7'					
		7'2"					
		8'					
		9'					
DOUBLES	4' + THRU 6'0"	6'8"					
		7'					
		7'2"					
		8'					
		9'					
	6' + THRU 8'0"	6'8"					
		7'					
		7'2"					
		8'					
		9'					
		10'					

GENERAL INFORMATION

CURRIES LLM series frames are available double rabbet equal or unequal, or single rabbet profile. Prices will reflect hardware preparations for 1 3/4" doors. Refer to CURRIES Architectural Technical Data Manual for standard details and limitations.

NOTE: 5-3/4" jamb depth frames have 1/2" minimum back bend. 7/16" N.A.

2" face frames are standard. 1", 1 1/4", 1 1/2", & 1 3/4" face frames are available.

Jamb depth ranges are listed above each column. 1/8" increment jamb depths (all ranges 3 1/2" thru 14") are available.

ANCHORS - foot clips are welded in place

Standard loose jamb anchors are included; 3 per jamb up to 7'6" and 4 per jamb over 7'6". Complete anchor information is listed in the Engineered Frame Section.

Welding charge only per anchor
(Add for appropriate anchor)

Factory Quoted

NOTE: This product is manufactured offsite and ships separately
Call to verify lead-times, freight cost, and ship schedule

EXTRAS

BUNDLING AND TAGGING FRAMES

Factory Quoted

Frame Order Code 3F, 3FH, 3FV, 2F, SL, BL, and 4F
Welded Frames

LEAD THICKNESS

Factory Quoted

- 1/16" Lead
- 1/8" Lead
- 3/16" Lead
- 1/4" Lead

Alternate thicknesses may be available

LLM Series Frames - 12 Ga Lead Lined 1/32" Lead Lined Frame Prices

May, 2024

EXTRAS		EXTRAS	
DUTCH DOOR FRAME	Factory Quoted	HARDWARE PREPARATIONS	
		CLOSER PREPARATIONS	Factory Quoted
Four (4") INCH FACE HEADS (4-5/8" MIN)	Factory Quoted	Concealed closer	
Single including 4'0"		Regular arm	E10
Pairs over 4'0"		Parallel arm	E11
		Half Sleeve	E18
GALVANNEAL (A60) FRAME ADDS	Factory Quoted	Full Sleeve	E17
Price per 3 sided frame		FLUSH BOLTS	Factory Quoted
GALVANIZED (G-90)	Factory Quoted	Standard ANSI 115.4	H2
Price per 3 Sided frame		Reversible (strike plate included)	H5
FIRE FRAME LABELS		Reinforce only	H1
UNDERWRITERS LABORATORIES	Factory Quoted	HINGE PREPARATIONS	Factory Quoted
Single Frame		3 1/2" 1 pair or 1 1/2 pair	
Double frame		4 1/2" standard or heavyweight	
		1 1/2 pair up to and including 7'6"	
		2 pair over 7'6" to 8'0"	
		5" standard or heavyweight	
		Full surface mounted continuous hinge reinforcement	
		High frequency reinforcement strap support	
		Per hinge	
		HOLDERS	Factory Quoted
		Overhead concealed	
		Overhead stop and holder surface mounted 14 ga	
		PIVOTS	Factory Quoted
		Top and bottom set single acting	
		Intermediate pivot single acting	
		PANIC EXIT REINFORCING	Factory Quoted
		Rim type	E8
		Rim vertical rod surface mounted strike	E5
		Vertical rod mortise strike in head - Each	G20
		STRIKES	Factory Quoted
		4 7/8" ANSI lipped strike 1 3/4" door	E1
		2 3/4" ANSI lipped strike 1 3/8" or 1 3/4" door	E2
		3 1/2" ANSI deadlock strike 1 3/8" or 1 3/4" door	E3
		2 3/4" ANSI deadlock strike 1 3/8" or 1 3/4" door	E4
		Electric strike frame	E9
		(includes cover box with knockout)	
		SURFACE BOLTS	Factory Quoted
		Reinforcement only	

EMI-RFI Shielding Flush Door Prices

749 Series and 750 Series



May, 2024

WIDTH	HEIGHT	16 GA	14 GA	12 GA
20, 24, 26, 28, 210, 30	68	FACTORY QUOTE ONLY at specialtypricing.curries@assaabloy.com For faster quote turnaround, please use the QQF (Quick Quote Forms) located on Connect		
34, 36	68			
38, 310, 40	68			
20, 24, 26, 28, 210, 30	70			
34, 36	70			
38, 310, 40	70			
20, 24, 26, 28, 210, 30	72			
34, 36	72			
38, 310, 40	72			
30	80			
34, 36	80			
38, 310, 40	80			
30	90			
34, 36	90			
38, 310, 40	90			
30	100			
34, 36	100			
38, 310, 40	100			

STANDARD DESCRIPTION

1 3/4" Door with EMI-RFI Shielding Effectiveness up to 103 db from 9kHz to 18 GHz per IEEE 299-2006 standard. May be used in specific TEMPEST applications dependent on customer requirements.

Up to STC 50 construction with SCIF compliance

EMI-RFI Door and Frame, conductive perimeter seals, shielding materials and Pemko threshold included.

EDGE BEVELS AVAILABLE

Factory Quoted

A standard (1/8" in 2" lock edge-square hinge edge)

"B" specify (square both edges)

"G" specify (1/8" in 2" bevel both edges)

OPTIONS

304 and 316 Stainless Steel

Factory Quoted

All finishes available

NON STANDARD SIZE DOORS

Factory Quoted

CORES - Varies

Factory Quoted

OPENING	LOCK	AVERAGE SHIELDING EFFECTIVENESS (IEE-299-2006)	SHIELDING PROTECTION UP TO	STC CONSTRUCTION
Singles	Mortise or Cylindrical	68.72 (9 kHz - 18 GHz)	87 dB	STC 45-50
Singles	Lockmaster (SCIF)	68.84 (9 kHz - 18 GHz)	103 dB	STC 45-50
Pairs	Exit Device	64.10 (9 kHz - 18 GHz)	93 dB	STC 45-50

NOTE: This product is manufactured offsite and ships separately
Call to verify lead-times, freight cost, and ship schedule

**EMI-RFI Shielded Frame Prices
RM Series 16, 14, and 12 Gauge**

May, 2024

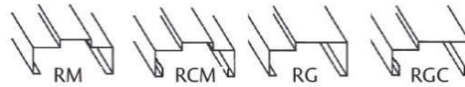

	WIDTH	HEIGHT	3 1/2 THRU 6	6-1/8 THRU 7-7/8	8 THRU 9-7/8	10 THRU 11-7/8	12 THRU 14
SINGLES	1'6" THRU 3'0"	6'8"	FACTORY QUOTE ONLY at specialtypricing.curries@assaabloy.com For faster quote turnaround, please use the QQF (Quick Quote Forms) located on Connect				
		7'					
		7'2"					
		8'					
		9'					
	3' + THRU 4'0"	10'					
		6'8"					
		7'					
		7'2"					
		8'					
DOUBLES	4' + THRU 6'0"	9'					
		10'					
		6'8"					
		7'					
		7'2"					
	6' + THRU 8'0"	8'					
		9'					
		10'					
		6'8"					
		7'					

GENERAL INFORMATION

CURRIES RM series frames are available double rafter equal or unequal, or single rafter profile. Prices will reflect hardware preparations for 1 3/4" doors. Refer to CURRIES Architectural Technical Data Manual for standard details and limitations.

NOTE: 5-3/4" jamb depth frames have 1/2" minimum back bend. 7/16" N.A.

2" face frames are standard. 1", 1 1/4", 1 1/2", & 1 3/4" face frames are available.

Jamb depth ranges are listed above each column. 1/8" increment jamb depths (all ranges 3 1/2" thru 14") are available at no extra charge.

ANCHORS - foot clips are welded in place. Standard loose jamb anchors are included; 3 per jamb up to 7'6" and 4 per jamb over 7'6". Complete anchor information is listed in the Engineered Frame Section.

304 or 316 Stainless Steel construction with all finish options available.

Welding charge only per anchor
(Add for appropriate anchor)

Factory Quoted

NOTE: This product is manufactured offsite and ships separately. Call to verify lead-times, freight cost, and ship schedule.

EXTRAS

BUNDLING AND TAGGING FRAMES

Frame Order Code 3F, 3FH, 3FV, 2F, SL, BL, and 4F
Welded Frames

Factory Quoted

Stainless Steel Flush Door Prices

707 Series and 747 Series

May, 2024



WIDTH	HEIGHT	18 GA	16 GA	14 GA	12 GA
20, 24, 26, 28, 210, 30	68	FACTORY QUOTE ONLY at specialtypricing.curries@assaabloy.com For faster quote turnaround, please use the QQF (Quick Quote Forms) located on Connect			
34, 36	68				
38, 310, 40	68				
20, 24, 26, 28, 210, 30	70				
34, 36	70				
38, 310, 40	70				
20, 24, 26, 28, 210, 30	72				
34, 36	72				
38, 310, 40	72				
30	80				
34, 36	80				
38, 310, 40	80				
30	90				
34, 36	90				
38, 310, 40	90				
30	100				
34, 36	100				
38, 310, 40	100				

NOTE: This product is manufactured offsite and ships separately
Call to verify lead-times, freight cost, and ship schedule

STANDARD DESCRIPTION

Polystyrene core with an "A" bevel
 Exposed seam "S" edge is standard on 18 ga. doors up to 9'0"
 "T" edge standard on 10'0"
 Welded "T" edge is standard on 16, 14, 12 ga. Doors

EDGE BEVELS AVAILABLE

Factory Quoted

A standard (1/8" in 2" lock edge-square hinge edge)
 "B" specify (square both edges)
 "G" specify (1/8" in 2" bevel both edges)
 Bull nose-one edge

OPTIONS

Factory Quoted

"T" continuous wire welded option-18 ga only up to 9'0"

FINISH

Factory Quoted

		<u>Code</u>	
304-4	Brush finish	SS	STD
304-6	Satin finish	46	
304-8	Mirror finish	48	
304-2B	Paint grade finish	4M	
304-XLB	XL blend	4X	
316-4	Brush finish	64	
316-6	Satin finish	66	
316-8	Mirror finish	68	
316-2B	Paint grade	6M	
316-XLB	XL blend	6X	

NON STANDARD SIZE DOORS

Factory Quoted

LISTED FIRE LABEL DOORS

Factory Quoted

Label door restrictions per gauge and size can be determined in the current CURRIES product brochure.
 Underwriters Laboratories B and C
 20 minute U.L.

CORES

Factory Quoted

Honeycomb
 Polyurethane

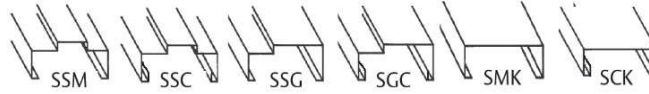

	WIDTH	HEIGHT	3 1/2 THRU 6	6-1/8 THRU 7-7/8	8 THRU 9-7/8	10 THRU 11-7/8	12 THRU 14	
SINGLES	1'6" THRU 3'0"	6'8"	FACTORY QUOTE ONLY at specialtypricing.curries@assaabloy.com For faster quote turnaround, please use the QQF (Quick Quote Forms) located on Connect					
		7'						
		7'2"						
		8'						
		9'						
		10'						
	3' + THRU 4'0"	6'8"						
		7'						
		7'2"						
		8'						
		9'						
		10'						
DOUBLES	4' + THRU 6'0"	6'8"						
		7'						
		7'2"						
		8'						
		9'						
		10'						
	6' + THRU 8'0"	6'8"						
		7'						
		7'2"						
		8'						
		9'						
		10'						

GENERAL INFORMATION

CURRIES SSM series frame available in double rabbet in single rabbet or cased opening. Prices will reflect hardware preparations for 1 3/4" doors. Refer to CURRIES Architectural Technical Data Manual for standard details and limitations.

NOTE: 5-3/4" jamb depth frames have 1/2" minimum back bend. 7/16" N.A.

2" face frames are standard. 1", 1 1/4", 1 1/2", & 1 3/4" face frames are available.

Jamb depth ranges are listed above each column. 1/8" increment jamb depths (all ranges 3 1/2" thru 14") are available.

Stainless finishes available in either 304 or 316 type stainless:

		Code	
304-4	Brush finish	SS	STD
304-6	Satin finish	46	
304-8	Mirror finish	48	
304-2B	Paint grade finish	4M	
304-XLB	XL blend	4X	
316-4	Brush finish	64	
316-6	Satin finish	66	
316-8	Mirror finish	68	
316-2B	Paint grade	6M	
316-XLB	XL blend	6X	

NOTE: This product is manufactured offsite and ships separately
 Call to verify lead-times, freight cost, and ship schedule

ANCHORS - foot clips are welded in place

Standard loose jamb anchors are included.

3 per jamb up to 7'6" and 4 per jamb over 7'6". Complete anchor information is listed in the Engineered Frame Section

EXTRAS

BUNDLING AND TAGGING FRAMES

Factory Quoted

Frame Order Code 3F, 3FH, 3FV, 2F, SL, BL, and 4F
 Welded Frames

LISTED FIRE LABELS

Factory Quoted

3-sided frames only (consult factory for details)
 UL label (does not include closer reinforcement)
 Single frame
 Double frame

NON STANDARD SIZE FRAMES

Factory Quoted

WIDTH	HEIGHT	16 GA	14 GA	12 GA
20, 24, 26, 28, 210, 30	68	<p align="center">FACTORY QUOTE ONLY at specialtypricing.curries@assaabloy.com For faster quote turnaround, please use the QQF (Quick Quote Forms) located on Connect</p>		
34, 36	68			
38, 310, 40	68			
20, 24, 26, 28, 210, 30	70			
34, 36	70			
38, 310, 40	70			
20, 24, 26, 28, 210, 30	72			
34, 36	72			
38, 310, 40	72			
30	80			
34, 36	80			
38, 310, 40	80			
30	90			
34, 36	90			
38, 310, 40	90			
30	100			
34, 36	100			
38, 310, 40	100			

STANDARD DESCRIPTION

Polystyrene core with an "A" bevel and continuous welded "T" edge is standard

1-3/4" Thick Door. A60 steel is standard

EDGE BEVELS AVAILABLE

Factory Quoted

A standard (1/8" in 2" lock edge-square hinge edge)

"B" specify (square both edges)

"G" specify (1/8" in 2" bevel both edges)

Galvanized (G90)

Factory Quoted

- a) 68 HEIGHT
- b) 70 HEIGHT
- c) 72 HEIGHT
- d) 80 HEIGHT
- e) 90 HEIGHT
- f) 100 HEIGHT

NON STANDARD SIZE DOORS

Factory Quoted

LISTED FIRE LABEL DOORS

Not Available

FITTED SEALS AND O-RINGS-BY OTHERS

CORES

Polyurethane

Factory Quoted

NOTE: This product is manufactured offsite and ships separately
Call to verify lead-times, freight cost, and ship schedule

780 Series Doors - Water Resistant Water Resistant Flush Door Prices

May, 2024

EXTRAS	Factory Quoted	EXTRAS	Factory Quoted
ASTRAGALS		LOCK PREPARATIONS CONTINUED	
Flat astragal shipped loose (pair only)		Mortise lock 1 3/4" door escutcheon trim	G3
		Mortise lock 1 3/4" door sectional trim	G3A*
CAPS — top or bottom	Factory Quoted	Hotel and master ring cylinder functions	
Steel installed flush (sealed)		Mortise lock edge only preparation	G3AEO
Top or bottom cap welded		Mortise lock reinforce only	G3ARO
		Mortise panic exit	G12*
CLOSER	Factory Quoted	Rim panic reinforce only	G11
Surface mounted, reinforcement only		Rim panic reinforce with function holes	G11*
		Rim vertical rod reinforce only	G11A
FLUSH BOLTS OR SURFACE BOLTS	Factory Quoted	Rim vertical rod with function holes	G11A*
Top and bottom flush bolt ANSI A115.4	H1	Concealed vertical rods	G12A*
(when used without astragal or with flat bar astragal)			
Top and bottom surface bolt reinforced only	SB	STRIKES	Factory Quoted
		4 7/8" ANSI lipped strike 1 3/4" door	E1
HINGE PREPARATIONS	Factory Quoted	2 3/4" ANSI lipped strike 1 3/4" door	E2
4 1/2" standard or heavyweight		3 1/2" ANSI deadlock strike	E3
5" Hinge standard or heavyweight		2 3/4" ANSI deadlock strike	E4
1 1/2 pair up to and including 7'6"		Electric strike	E9*
2 pair over 7'6" to 10'0"		Electric raceway	
Anchor hinge set		Open back strike non label door	*
(e.g. McKinney TA792) No drill, no tap			
(e.g. McKinney TA793)		*Advise of manufacturer and function of hardware.	
Continuous hinge preparation (mounting holes field drilled)		Hardware function holes do not include trim mounting holes	
Concealed mounting		UNDERCUTS	Factory Quoted
(e.g. McKinney - 11, 24)		1 3/4" doors-5/8" standard, 3/8", 3/4" available.	
12 gauge hinge rail available (Specify)		All other undercuts per door	
Surface mounting			
(e.g. McKinney-21, 53)		VISION KITS	Factory Quoted
LOCK PREPARATIONS	Factory Quoted	Vision kits installed- glass by others (specify glass thickness)	
Cylindrical lock 1-3/4" door 161	G2	1/4" thick glass standard	
Cylindrical lock 1-3/4" door lever trim	G2B*	FV	
(Universal lever trim prep)		FNV	
Deadlock 1 3/4" door tubular 181	G16	HG	
Deadlock 1 3/4" door mortise 190	G17	FG	
Interconnected lock	G25		

26
787 Series Doors - Steel Stiffened Water Resistant
Water Resistant Flush Door Prices



May, 2024

WIDTH	HEIGHT	16 GA	14 GA	12 GA
20, 24, 26, 28, 210, 30	68	FACTORY QUOTE ONLY at specialtypricing.curries@assaabloy.com For faster quote turnaround, please use the QQF (Quick Quote Forms) located on Connect		
34, 36	68			
38, 310, 40	68			
20, 24, 26, 28, 210, 30	70			
34, 36	70			
38, 310, 40	70			
20, 24, 26, 28, 210, 30	72			
34, 36	72			
38, 310, 40	72			
30	80			
34, 36	80			
38, 310, 40	80			
30	90			
34, 36	90			
38, 310, 40	90			
30	100			
34, 36	100			
38, 310, 40	100			

STANDARD DESCRIPTION

Steel Stiffened core with an "A" bevel and continuous welded "T" edge is standard

A60 steel is standard

1-3/4" Thick Door

EDGE BEVELS AVAILABLE

Factory Quoted

"A" standard (1/8" in 2" lock edge-square hinge edge)

"B" specify (square both edges)

"G" specify (1/8" in 2" bevel both edges)

OPTIONS

Galvanized (G90)

Factory Quoted

a) 68 HEIGHT

b) 70 HEIGHT

c) 72 HEIGHT

d) 80 HEIGHT

e) 90 HEIGHT

f) 100 HEIGHT

NOTE: This product is manufactured offsite and ships separately
Call to verify lead-times, freight cost, and ship schedule

NON STANDARD SIZE DOORS

Factory Quoted

LISTED FIRE LABEL DOORS

Not Available

FITTED SEALS AND O-RINGS-BY OTHERS

787 Series Doors - Steel Stiffened Water Resistant Water Resistant Flush Door Prices

May, 2024

	EXTRAS			EXTRAS	
ASTRAGALS			Factory Quoted	LOCK PREPARATIONS CONTINUED	Factory Quoted
Flat astragal shipped loose (pair only)				Mortise lock 1 3/4" door escutcheon trim	G3
CAPS — top or bottom			Factory Quoted	Mortise lock 1 3/4" door sectional trim	G3A*
Steel installed flush (sealed)				Hotel and master ring cylinder functions	
Top or bottom cap welded				Mortise lock edge only preparation	G3AEO
CLOSER			Factory Quoted	Mortise lock reinforce only	G3ARO
Surface mounted, reinforcement only				Mortise panic exit	G12*
FLUSH BOLTS OR SURFACE BOLTS			Factory Quoted	Rim panic reinforce only	G11
Top and bottom flush bolt ANSI A115.4		H1		Rim panic reinforce with function holes	G11*
(when used without astragal or with flat bar astragal)				Rim vertical rod reinforce only	G11A
Top and bottom surface bolt reinforced only		SB		Rim vertical rod with function holes	G11A*
HINGE PREPARATIONS			Factory Quoted	Concealed vertical rods	G12A*
4 1/2" standard or heavyweight				STRIKES	Factory Quoted
5" Hinge standard or heavyweight				4 7/8" ANSI lipped strike 1 3/4" door	E1
1 1/2 pair up to and including 7'6"				2 3/4" ANSI lipped strike 1 3/4" door	E2
2 pair over 7'6" to 10'0"				3 1/2" ANSI deadlock strike	E3
Anchor hinge set				2 3/4" ANSI deadlock strike	E4
(e.g. McKinney TA792) No drill, no tap				Electric strike	E9*
(e.g. McKinney TA793)				Electric raceway	
Continuous hinge preparation (mounting holes field drilled)				Open back strike non label door	*
Concealed mounting				*Advise of manufacturer and function of hardware.	
(e.g. McKinney - 11, 24)				Hardware function holes do not include trim mounting holes	
12 gauge hinge rail available (Specify)				UNDERCUTS	Factory Quoted
Surface mounting				1 3/4" doors-5/8" standard, 3/8", 3/4" available.	
(e.g. McKinney-21, 53)				All other undercuts per door	
LOCK PREPARATIONS			Factory Quoted	VISION KITS	Factory Quoted
Cylindrical lock 1-3/4" door 161		G2		Vision kits installed- glass by others (specify glass thickness)	
Cylindrical lock 1-3/4" door lever trim		G2B*		1/4" thick glass standard	
(Universal lever trim prep)				FV	
Deadlock 1 3/4" door tubular 181		G16		FNV	
Deadlock 1 3/4" door mortise 190		G17		HG	
Interconnected lock		G25		FG	

WRM Series Frames - 16 Ga. Water Resistant Water Resistant Frame Prices

May, 2024

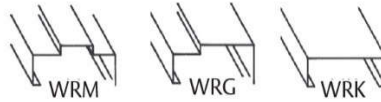

	WIDTH	HEIGHT	3 1/2 THRU 6	6-1/8 THRU 7-7/8	8 THRU 9-7/8	10 THRU 11-7/8	12 THRU 14
SINGLES	1'6" THRU 3'0"	6'8"	FACTORY QUOTE ONLY at specialtypricing.curries@assaabloy.com For faster quote turnaround, please use the QQF (Quick Quote Forms) located on Connect				
		7'					
		7'2"					
		8'					
		9'					
	3' + THRU 4'0"	6'8"					
		7'					
		7'2"					
		8'					
		9'					
DOUBLES	4' + THRU 6'0"	6'8"					
		7'					
		7'2"					
		8'					
		9'					
	6' + THRU 8'0"	6'8"					
		7'					
		7'2'					
		8'					
		9'					
		10'					

GENERAL INFORMATION

CURRIES WRM series frames are available double rabbet, equal or unequal, single rabbet profile or cased opening. Prices will reflect hardware preparations for 1 3/4" doors. Refer to CURRIES Architectural Technical Data Manual for standard details and limitations.

NOTE: 5-3/4" jamb depth frames have 1/2" minimum back bend. 7/16" N.A.

2" face frames are standard. 1", 1 1/4", 1 1/2", & 1 3/4" face frames are available.

Jamb depth ranges are listed above each column. 1/8" increment jamb depths (all ranges 3 1/2" thru 14") are available.

ANCHORS - foot clips are welded in place

Standard loose jamb anchors are included.

3 per jamb up to 7'6" and 4 per jamb over 7'6". Complete anchor information is listed in the Engineered Frame Section

Welding charge only per anchor
(Add for appropriate anchor)

Factory Quoted

EXTRAS

BUNDLING AND TAGGING FRAMES

Frame Order Code 3F, 3FH, 3FV, 2F, SL, BL, and 4F
Welded Frames

Factory Quoted

NOTE: This product is manufactured offsite and ships separately
Call to verify lead-times, freight cost, and ship schedule

WRM Series Frames - 16 Ga Water Resistant Water Resistant Frame Prices

May, 2024

EXTRAS		EXTRAS	
DUTCH DOOR FRAME	Factory Quoted	HARDWARE PREPARATIONS	
		CLOSER PREPARATIONS	Factory Quoted
Four (4") INCH FACE HEADS (4-5/8" MIN) JAMB DEPTH	Factory Quoted	Regular arm	E10
Single including 4'0"		Parallel arm	E11
Pairs over 4'0"		Half Sleeve	E18
		Full Sleeve	E17
GALVANNEAL (A60) NO ADD	Factory Quoted	FLUSH BOLTS	Factory Quoted
		Standard ANSI 115.4	H2
GALVANIZED (G-90)	Factory Quoted	Reversible (strike plate included)	H5
Price per 3 Sided frame		Reinforce only	H1
CASED OPENING FRAMES	Factory Quoted	HINGE PREPARATIONS	Factory Quoted
Price per frame		3 1/2" 1 pair or 1 1/2 pair	
		4 1/2" standard or heavyweight	
		1 1/2 pair up to and including 7'6"	
		2 pair over 7'6" to 8'0"	
		5" standard or heavyweight	
		Full surface mounted continuous hinge reinforcement	
		High frequency reinforcement strap support	
		Per hinge	
		HOLDERS	Factory Quoted
		Overhead stop and holder surface mounted 14 ga	
		PIVOTS	Factory Quoted
		Top and bottom set single acting	
		Intermediate pivot single acting	
		PANIC EXIT REINFORCING	Factory Quoted
		Rim type	E8
		Rim vertical rod surface mounted strike	E5
		Vertical rod mortise strike in head - Each	G20
		STRIKES	Factory Quoted
		4 7/8" ANSI lipped strike 1 3/4" door	E1
		2 3/4" ANSI lipped strike 1 3/8" or 1 3/4" door	E2
		3 1/2" ANSI deadlock strike 1 3/8" or 1 3/4"	E3
		2 3/4" ANSI deadlock strike 1 3/8" or 1 3/4"	E4
		Electric strike frame	E9
		(includes cover box with knockout)	
		SURFACE BOLTS	Factory Quoted
		Reinforcement only	

WRM Series Frames - 14 Ga. Water Resistant Water Resistant Frame Prices

May, 2024



	WIDTH	HEIGHT	3 1/2 THRU 6	6-1/8 THRU 7-7/8	8 THRU 9-7/8	10 THRU 11-7/8	12 THRU 14
SINGLES	1'6" THRU 3'0"	6'8"	FACTORY QUOTE ONLY at specialtypricing.curries@assaabloy.com For faster quote turnaround, please use the QQF (Quick Quote Forms) located on Connect				
		7'					
		7'2"					
		8'					
		9'					
	3' + THRU 4'0"	10'					
		6'8"					
		7'					
		7'2"					
		8'					
DOUBLES	4' + THRU 6'0"	9'					
		10'					
		6'8"					
		7'					
		7'2"					
	6' + THRU 8'0"	8'					
		9'					
		10'					
		6'8"					
		7'					

GENERAL INFORMATION

CURRIES WRM series frames are available double rabbet, equal or unequal, single rabbet profile or cased opening. Prices will reflect hardware preparations for 1 3/4" doors. Refer to CURRIES Architectural Technical Data Manual for standard details and limitations.

NOTE: 5-3/4" jamb depth frames have 1/2" minimum back bend. 7/16" N.A.

2" face frames are standard. 1", 1 1/4", 1 1/2", & 1 3/4" face frames are available.

Jamb depth ranges are listed above each column. 1/8" increment jamb depths (all ranges 3 1/2" thru 14") are available.

ANCHORS - foot clips are welded in place
 Standard loose jamb anchors are included.
 3 per jamb up to 7'6" and 4 per jamb over 7'6". Complete anchor information is listed in the Engineered Frame Section

Welding charge only per anchor **Factory Quoted**
 (Add for appropriate anchor)

EXTRAS

BUNDLING AND TAGGING FRAMES **Factory Quoted**
 Frame Order Code 3F, 3FH, 3FV, 2F, SL, BL, and 4F
 Welded Frames

NOTE:This product is manufactured offsite and ships separately
 Call to verify lead-times, freight cost, and ship schedule

WRM Series Frames - 14 Ga Water Resistant Water Resistant Frame Prices

May, 2024

EXTRAS	Factory Quoted	EXTRAS	Factory Quoted
DUTCH DOOR FRAME	Factory Quoted	HARDWARE PREPARATIONS	
		CLOSER PREPARATIONS	Factory Quoted
Four (4") INCH FACE HEADS (4-5/8" MIN) JAMB DEPTH	Factory Quoted	Regular arm	E10
Single including 4'0"		Parallel arm	E11
Pairs over 4'0"		Half Sleeve	E18
		Full Sleeve	E17
GALVANNEAL (A60) NO ADD	Factory Quoted	FLUSH BOLTS	Factory Quoted
		Standard ANSI 115.4	H2
GALVANIZED (G-90)	Factory Quoted	Reversible (strike plate included)	H5
Price per 3 Sided frame		Reinforce only	H1
CASED OPENING FRAMES	Factory Quoted	HINGE PREPARATIONS	Factory Quoted
Price per frame		3 1/2" 1 pair or 1 1/2 pair	
		4 1/2" standard or heavyweight	
		1 1/2 pair up to and including 7'6"	
		2 pair over 7'6" to 8'0"	
		5" standard or heavyweight	
		Full surface mounted continuous hinge reinforcement	
		High frequency reinforcement strap support	
		Per hinge	
		HOLDERS	Factory Quoted
		Overhead stop and holder surface mounted 14 ga	
		PIVOTS	Factory Quoted
		Top and bottom set single acting	
		Intermediate pivot single acting	
		PANIC EXIT REINFORCING	Factory Quoted
		Rim type	E8
		Rim vertical rod surface mounted strike	E5
		Vertical rod mortise strike in head - Each	G20
		STRIKES	Factory Quoted
		4 7/8" ANSI lipped strike 1 3/4" door	E1
		2 3/4" ANSI lipped strike 1 3/8" or 1 3/4" door	E2
		3 1/2" ANSI deadlock strike 1 3/8" or 1 3/4" door	E3
		2 3/4" ANSI deadlock strike 1 3/8" or 1 3/4" door	E4
		Electric strike frame	E9
		(includes cover box with knockout)	
		SURFACE BOLTS	Factory Quoted
		Reinforcement only	

WRM Series Frames - 12 Ga. Water Resistant

Water Resistant Frame Prices

May, 2024



	WIDTH	HEIGHT	3 1/2 THRU 6	6-1/8 THRU 7-7/8	8 THRU 9-7/8	10 THRU 11-7/8	12 THRU 14
SINGLES	1'6" THRU 3'0"	6'8"	FACTORY QUOTE ONLY at specialtypricing.curries@assaabloy.com For faster quote turnaround, please use the QQF (Quick Quote Forms) located on Connect				
		7'					
		7'2"					
		8'					
		9'					
	3' + THRU 4'0"	6'8"					
		7'					
		7'2"					
		8'					
		9'					
DOUBLES	4' + THRU 6'0"	6'8"					
		7'					
		7'2"					
		8'					
		9'					
	6' + THRU 8'0"	6'8"					
		7'					
		7'2'					
		8'					
		9'					
		10'					

GENERAL INFORMATION

CURRIES WRM series frames are available double rabbet, equal or unequal, single rabbet profile or cased opening. Prices will reflect hardware preparations for 1 3/4" doors. Refer to CURRIES Architectural Technical Data Manual for standard details and limitations.

NOTE: 5-3/4" jamb depth frames have 1/2" minimum back bend. 7/16" N.A.

2" face frames are standard. 1", 1 1/4", 1 1/2", & 1 3/4" face frames are available.

Jamb depth ranges are listed above each column. 1/8" increment jamb depths (all ranges 3 1/2" thru 14") are available.

ANCHORS - foot clips are welded in place
 Standard loose jamb anchors are included.
 3 per jamb up to 7'6" and 4 per jamb over 7'6". Complete anchor information is listed in the Engineered Frame Section

Welding charge only per anchor **Factory Quoted**
 (Add for appropriate anchor)

EXTRAS
BUNDLING AND TAGGING FRAMES **Factory Quoted**
 Frame Order Code 3F, 3FH, 3FV, 2F, SL, BL, and 4F
 Welded Frames

NOTE: This product is manufactured offsite and ships separately
 Call to verify lead-times, freight cost, and ship schedule

WRM Series Frames - 12 Ga Water Resistant Water Resistant Frame Prices

May, 2024

	EXTRAS		EXTRAS	
DUTCH DOOR FRAME		Factory Quoted	HARDWARE PREPARATIONS	
			CLOSER PREPARATIONS	Factory Quoted
Four (4") INCH FACE HEADS (4-5/8" MIN) JAMB DEPTH		Factory Quoted	Regular arm	E10
Single including 4'0"			Parallel arm	E11
Pairs over 4'0"			Half Sleeve	E18
			Full Sleeve	E17
GALVANNEAL (A60) NO ADD		Factory Quoted	FLUSH BOLTS	Factory Quoted
			Standard ANSI 115.4	H2
GALVANIZED (G-90)		Factory Quoted	Reversible (strike plate included)	H5
Price per 3 Sided frame			Reinforce only	H1
CASED OPENING FRAMES		Factory Quoted	HINGE PREPARATIONS	Factory Quoted
Price per frame			3 1/2" 1 pair or 1 1/2 pair	
			4 1/2" standard or heavyweight	
			1 1/2 pair up to and including 7'6"	
			2 pair over 7'6" to 8'0"	
			5" standard or heavyweight	
			Full surface mounted continuous hinge reinforcement	
			High frequency reinforcement strap support	
			Per hinge	
			HOLDERS	Factory Quoted
			Overhead stop and holder surface mounted 14 ga	
			PIVOTS	Factory Quoted
			Top and bottom set single acting	
			Intermediate pivot single acting	
			PANIC EXIT REINFORCING	Factory Quoted
			Rim type	E8
			Rim vertical rod surface mounted strike	E5
			Vertical rod mortise strike in head - Each	G20
			STRIKES	Factory Quoted
			4 7/8" ANSI lipped strike 1 3/4" door	E1
			2 3/4" ANSI lipped strike 1 3/8" or 1 3/4" door	E2
			3 1/2" ANSI deadlock strike 1 3/8" or 1 3/4" door	E3
			2 3/4" ANSI deadlock strike 1 3/8" or 1 3/4" door	E4
			Electric strike frame	E9
			(includes cover box with knockout)	
			SURFACE BOLTS	Factory Quoted
			Reinforcement only	

707 Series Doors-Attack Resistant Door with Glass - Non Rated Attack Resistant Door Prices

May, 2024



WIDTH	HEIGHT	16 GA	14 GA
28, 210, 30	68	FACTORY QUOTE ONLY at specialtypricing.curries@assaabloy.com For faster quote turnaround, please use the QQF (Quick Quote Forms) located on Connect	
34, 36	68		
38, 310, 40	68		
28, 210, 30	70		
34, 36	70		
38, 310, 40	70		
28, 210, 30	72		
34, 36	72		
38, 310, 40	72		
30	80		
34, 36	80		
38, 310, 40	80		

NOTE:

Door tested to 5aa 10 test method. Single doors only.
 Lock type (lock by others): Equivilant hardware not test.
 Sargent 8200 mortise lock with latch bolt, dead bolt function and LS escutcheon
 Corbin Russwin ML2000 series mortise lock with deadbolt, VR escutcheon
 and lever trim
 ASSA ABLOY ACCENTRA SL8800 series mortise lock with deadbolt, SL escutcheon and lever

Door glass size (visible): width 3" minimum; 35-13/16" maximum -
 height 10" minimum; 44" maximum.

Sidelight glass size (visible): 12" x 12" - 47" x 92-3/4"

Borrowed light glass size (visible): 12" x 12" - 95" x 47" horizontal oriented or
 12" x 12" - 95" x 47" vertical oriented.

For 3F frames: Refer to the M or CM sesries frame section - KD or welded
 Jambs 2" face, Head 2" - 4" face.

For sidelite/borrowed lite frame: Refer to the CCW section for
 elevations. Jambs 2" face, mullion 2" face, sill 2" - 10" face

NON STANDARD SIZE DOORS

Factory Quoted

LISTED FIRE LABEL DOORS - Not Available

STANDARD DESCRIPTION

Polystyrene core core with an "A" edge bevel and exposed seam
 "S" edge are standard
 1-3/4" Thick Door

EDGE BEVELS AVAILABLE

Factory Quoted

"A" standard (1/8" in 2" lock edge-square hinge ed

Galvanneal Steel (A60)

Factory Quoted

- a) 68 HEIGHT
- b) 70 HEIGHT
- c) 72 HEIGHT
- d) 80 HEIGHT

Galvanized (G90) includes epoxy primer

Factory Quoted

- a) 68 HEIGHT
- b) 70 HEIGHT
- c) 72 HEIGHT
- d) 80 HEIGHT

"N" Seamless edge filled

Factory Quoted

"T" Continuous Wire Welded

Factory Quoted

12 Gauge Hinge Rail

Factory Quoted

Visual ID tag

Factory Quoted

Honeycomb core

Factory Quoted

Polyurethane core

Factory Quoted

VISION KITS-Type 2 standard w/surround char **Factory Quoted**

FV

FNV

HG

Attack resistant glass must be factory installed

VISION KITS-Type 10 w/surround channel **Factory Quoted**

Factory Quoted

FV

FNV

HG

Attack resistant glass must be factory installed

GLASS - Factory Installed in Doors

Factory Quoted

FV

ARG

FNV

ARG

HG

ARG

Attack resistant glass

Min. visible glass width 3"; Max. width 35--13/16"

Min. visible glass height 10"; Max. height 44"

FRAMES - Glass Attack Resistant

Factory Quoted

Attack resistant glass for sidelight/borrowed lights (minimum 3 sq. ft)
 ships loose

Sidelight and borrowed light glass is included but shipped loose for
 field installation by others per installation instructions provided with
 the SG5™ glass

Attack Resistant Retro-Fit Kits**Attack Resistant Prices**

May, 2024



Retro-Fit Kit includes: Attack Resistant glass kit, SG5 glass, tape and glazing compound for installation into existing metal or wood doors. Kit and glass shipped loose and installed by others.

TYPE 2 HM Door	Visible Glass Size	Cutout Size	Part Number	Unit List
ARKMV	10 X 10	11-3/4 x 11-3/4	CD149692	Factory Quoted
ARKMV1212	12 X 12	13-3/4 x 13-3/4	CD150402	Factory Quoted
ARKMNV616	6 X 16	7-3/4 x 17-3/4	CD151232	Factory Quoted
ARKMNV636	6 X 36	7-3/4 x 37-3/4	CD152062	Factory Quoted
ARKMNV333	3 X 33	4-3/4 x 34-3/4	CD154462	Factory Quoted
ARKMNV424	4 X 24	5-3/4 x 25-3/4	CD155292	Factory Quoted
ARKMNV520	5 X 20	6-3/4 x 21-3/4	CD156022	Factory Quoted
ARKMNV624	6 X 24	7-3/4 x 25-3/4	CD156852	Factory Quoted
ARKMNV630	6 X 30	7-3/4 x 31-3/4	CD157682	Factory Quoted
ARKMNV425	4 X 25	5-3/4 x 26-3/4	CD158422	Factory Quoted
ARKMHG (3068)	23-13/16 X 28	25-9/16 x 29-3/4	CD159252	Factory Quoted
ARKMHG (3070)	23-13/16 X 32	25-9/16 X 33-3/4	CD160062	Factory Quoted
ARKMHG (3072)	23-13/16 X 34	25-9/16 X 35-3/4	CD160892	Factory Quoted
ARKMC	Custom Size Retro-Fit kits are priced per Sq. Ft. of visible glass (3 sq ft min.)			Factory Quoted

TYPE 10 Wood Door	Visible Glass Size	Cutout Size	Part Number	Unit List
ARKWV	10 X 10	12-1/8 x 12-1/8	CD137632	Factory Quoted
ARKWV1212	12 X 12	14-1/8 x 14-1/8	CD138472	Factory Quoted
ARKWNV616	6 X 16	8-1/8 x 18-1/8	CD139202	Factory Quoted
ARKWNV636	6 X 36	8-1/8 x 38-1/8	CD140012	Factory Quoted
ARKWNV333	3 X 33	5-1/8 x 35-1/8	CD142412	Factory Quoted
ARKWNV424	4 X 24	6-1/8 x 26-1/8	CD143242	Factory Quoted
ARKWNV520	5 X 20	7-1/8 x 22-1/8	CD144072	Factory Quoted
ARKWNV624	6 X 24	8-1/8 x 26-1/8	CD144802	Factory Quoted
ARKWNV630	6 X 30	8-1/8 x 32-1/8	CD145632	Factory Quoted
ARKWNV425	4 X 25	6-1/8 x 27-1/8	CD146472	Factory Quoted
ARKWHG (3068)	23-5/16 X 27-1/4	25-7/16 x 29-3/8	CD147202	Factory Quoted
ARKWHG (3070)	23-5/16 X 31-1/4	25-7/16 x 33-3/8	CD148032	Factory Quoted
ARKWHG (3072)	23-5/16 X 33-1/4	25-7/16 x 35-3/8	CD148862	Factory Quoted
ARKWC	Custom Size Retro-Fit kits are priced per Sq. Ft. of visible glass (3 sq ft min.)			Factory Quoted

Attack Resistant Retro-fit Kits must be used with the Attack Resistant component materials as supplied: AADG Kits, SGG5 Glass, approved and tested installation components only - NO SUBSTITUTIONS.

Curries and School Guard Glass are committed to providing the safest and most robust means and methods for attachment into complete factory installed OEM Attack Resistant assemblies as well as the repair, partial replacement or enhancement of existing doors and frames. We have independent testing parties regularly test our installation procedures and products as well as the frames and glass it is installed into. However, please be advised that it is possible that not all existing doors, frames, or hardware on your project have been tested to our standards. Furthermore, if doors, windows or hardware are old, of inferior quality, broken or partially broken, then they may not meet the testing outcomes that new materials meet. Our products will not cause your existing products to be less secure, but existing products that are defective may reduce the ability of our products to meet their full potential.

WIDTH	HEIGHT	16 GA	14 GA
28, 210, 30	68	FACTORY QUOTE ONLY at specialtypricing.curries@assaabloy.com For faster quote turnaround, please use the QQF (Quick Quote Forms) located on Connect	
34, 36	68		
38, 310, 40	68		
28, 210, 30	70		
34, 36	70		
38, 310, 40	70		
28, 210, 30	72		
34, 36	72		
38, 310, 40	72		
30	80		
34, 36	80		
38, 310, 40	80		

NOTE:

Door tested to 5aa 10 test method. Single doors only.
 Lock type (lock by others): Equilant hardware not test.
 Sargent 8200 mortise lock with latch bolt, dead bolt function and LS escutcheon
 Corbin Russwin ML2000 series mortise lock with deadbolt, VR escutcheon
 and lever trim
 ASSA ABLOY ACCENTRA SL8800 series mortise lock with deadbolt, SL escutcheon and lever

Door glass size (visible): width 3" - 35-13/16" x height 10" - 44"

Multiple sidelight and borrowed light sizes available.

For 3F frames: Refer to the M or CM series frame section - KD or welded
 Jambs 2" face, Head 2" - 4" face.

For sidelite/borrowed lite frame: Refer to the CCW section for
 elevations. Jambs 2" face, mullion 2" face, sill 2" - 10" face

NON STANDARD SIZE DOORS

Factory Quoted

FRAMES - GLASS ATTACK RESISTANT

Factory Quoted

Attack resistant glass for sidelight/borrowed lights (minimum 3 sq. ft)	
ships loose	20
	45
	60
	90

Sidelight and borrowed light glass is included but shipped loose for
 field installed by others per installation instructions provided with
 the SG5™ glass.

STANDARD DESCRIPTION

Polystyrene core with an "A" edge bevel and exposed seam "S"
 edge are standard
 1-3/4" Thick Door

EDGE BEVELS AVAILABLE

Factory Quoted

"A" standard (1/8" in 2" lock edge-square hinge edge)

Galvanized (A60)

Factory Quoted

a) 68 HEIGHT

b) 70 HEIGHT

c) 72 HEIGHT

d) 80 HEIGHT

Galvanized (G90) includes epoxy primer

Factory Quoted

a) 68 HEIGHT

b) 70 HEIGHT

c) 72 HEIGHT

d) 80 HEIGHT

"N" Seamless edge filled

Factory Quoted

"T" Continuous Wire Welded

Factory Quoted

12 Gauge Hinge Rail

Factory Quoted

Visual ID tag

Factory Quoted

Honeycomb core

Factory Quoted

Polyurethane core

Factory Quoted

Warnock Hersey

B, C, 20 min

Factory Quoted

VISION KIT-TYPE 8

Factory Quoted

FV

FNV

HG

Attack resistant glass must be factory installed, see options

Glass Attack Resistant - installed 20 min rating

Factory Quoted

FV ARG20

FNV ARG20

HG ARG20

Glass Attack Resistant - installed 45 min rating

Factory Quoted

FV ARG45

FNV ARG45

HG ARG45

Glass Attack Resistant - installed 60 min rating

Factory Quoted

FV ARG60

FNV ARG60

HG ARG60

Glass Attack Resistant - installed 90 min rating

Factory Quoted

FV ARG90

FNV ARG90

HG ARG90

707 Series Doors - Attack Resistant Door with Glass
Fire Rated Attack Resistant Door Prices

May, 2024

EXTRAS	EXTRAS			
<p>CAPS — top or bottom Steel installed flush (with screws per cap)</p> <p>CLOSER Surface mounted, reinforcement only Concealed or semi-concealed</p> <p>HINGE PREPARATIONS 4 1/2" standard or heavyweight Continuous hinge preparation (mounting holes field drilled) Concealed mounting</p>	<table border="0" style="width: 100%;"> <tr> <td style="width: 50%; vertical-align: top;"> <p>Factory Quoted</p> <p>Factory Quoted</p> <p>Factory Quoted</p> </td> <td style="width: 50%; vertical-align: top;"> <p>LOCK PREPARATIONS CONTINUED Mortise lock 1 3/4" door sectional trim</p> <p>UNDERCUTS 1 3/4" doors-5/8" standard, 3/8", 3/4" available. All other undercuts up to 3/4"</p> </td> <td style="width: 50%; vertical-align: top;"> <p>Factory Quoted</p> <p>Factory Quoted</p> </td> </tr> </table>	<p>Factory Quoted</p> <p>Factory Quoted</p> <p>Factory Quoted</p>	<p>LOCK PREPARATIONS CONTINUED Mortise lock 1 3/4" door sectional trim</p> <p>UNDERCUTS 1 3/4" doors-5/8" standard, 3/8", 3/4" available. All other undercuts up to 3/4"</p>	<p>Factory Quoted</p> <p>Factory Quoted</p>
<p>Factory Quoted</p> <p>Factory Quoted</p> <p>Factory Quoted</p>	<p>LOCK PREPARATIONS CONTINUED Mortise lock 1 3/4" door sectional trim</p> <p>UNDERCUTS 1 3/4" doors-5/8" standard, 3/8", 3/4" available. All other undercuts up to 3/4"</p>	<p>Factory Quoted</p> <p>Factory Quoted</p>		

40
859 Series Doors-Forced Entry Level 8 Bullet Resistant Door
Forced Entry Door Prices



May, 2024

WIDTH	HEIGHT	12 GA
30	70	Factory Quoted

**Submit quote to -
SpecialtyPricing.Curries@assaabloy.com**

For faster quote turnaround, please use the QQF (Quick Quote Forms) located on Connect.

Door tested per DoS ST-STD.01.01

Single and pairs available.

Available in 5 minute, 15 minute and 60 minute assemblies.

NOTE: This product is manufactured offsite and ships separately
Call to verify lead-times, freight cost, and ship schedule

STANDARD DESCRIPTION

Proprietary core construction. Continuous welded "T" edge is standard 1-3/4" Thick Doors

EDGE BEVELS AVAILABLE

Factory Quoted

"A" standard (1/8" in 2" lock edge-square hinge edge)

OPTIONS

Factory Quoted

Galvanneal steel (A60)

Galvanized (G90) includes epoxy primer

LISTED FIRE LABEL DOORS

Not Available

VISION KITS

Not Available

EXTRAS

CAPS - top and bottom

Factory Quoted

CLOSER

Factory Quoted

Surface mounted, reinforcement only

UNDERCUTS

Factory Quoted

1 3/4" doors-3/4" standard

**FEM Series 12 ga - Forced Entry Level 8 Bullet Resistant Frame
 Forced Entry Frame Prices**

May, 2024

	WIDTH	HEIGHT	5 3/4 THRU 6	6-1/8 THRU 7-7/8	8 THRU 9-7/8	10 THRU 11-7/8	12 THRU 14	
SINGLES	30	7'	Factory Quoted					

GENERAL INFORMATION

CURRIES FEM series frames are available double rabbet, equal or unequal. Refer to CURRIES Architectural Technical Data Manual for standard details and limitations.

NOTE: 5-3/4" jamb depth frames have 1/2" minimum back bend. 7/16" N.A.

2" face frames are standard.

1" stop height standard

Jamb depth ranges are listed above each column.

1/8" increment jamb depths (all ranges 5 3/4" thru 14") are available.

Submit Quote to: SpecialtyPricing.Curries@assaabloy.com

For faster quote turnaround, please use the QQF (Quick Quote Forms) located on Connect.

NOTE: This product is manufactured offsite and ships separately
 Call to verify lead-times, freight cost, and ship schedule

ANCHORS - existing opening

OPTIONS

Galvanneal steel (A60) per 3 sided frame

Galvanized (G90) per 3 sided frame

Factory Quoted

EXTRAS

BUNDLING AND TAGGING FRAMES

Frame Order Code 3F, 3FH, 3FV, 2F, SL, BL, and 4F
 Welded Frames

Factory Quoted

CLOSER REINFORCEMENT

FOUR (4") INCH FACE HEAD

FIRE RATING

Not Available

Not Available

Not Available

789 Series Doors - Steel Stiffened Flood Resistant Flood Resistant Flush Door Prices



May, 2024

WIDTH	HEIGHT	16 GA	14 GA	12 GA
20, 24, 26, 28, 210, 30	68	FACTORY QUOTE ONLY at specialtypricing.curries@assaabloy.com For faster quote turnaround, please use the QQF (Quick Quote Forms) located on Connect		
20, 24, 26, 28, 210, 30	70			

STANDARD DESCRIPTION

Steel stiffened core core with an "A" bevel and continuous "T" edge is standard. A60 steel is standard
1-3/4" Thick Door

Available in seated position only (water pressure on pull side of door).

EDGE BEVELS AVAILABLE

Factory Quoted

"A" standard (1/8" in 2" lock edge-square hinge

"B" specify (square both edges)

"G" specify (1/8" in 2" bevel both edges)

**NOTE: This product is manufactured offsite and ships separately
Call to verify lead-times, freight cost, and ship schedule**

OPTIONS

Factory Quoted

Galvanized (G90)

a) 68 HEIGHT

b) 70 HEIGHT

NON STANDARD SIZE DOORS

Factory Quoted

LISTED FIRE LABEL DOORS

Not Available

**789 Series Doors - Steel Stiffened Flood Resistant
Flood Resistant Flush Door Prices**

May, 2024

<p>EXTRAS</p> <p>CAPS — top or bottom Top and bottom cap welded</p> <p>CLOSER Surface mounted, reinforcement only</p> <p>HINGE PREPARATIONS 4 1/2" standard or heavyweight 5" Hinge standard or heavyweight 1 1/2 pair up to and including 7'6" Anchor hinge set (e.g. McKinney TA792) No drill, no tap (e.g. McKinney TA793) Continuous hinge preparation (mounting holes field drilled) Concealed mounting (e.g. McKinney - 11, 24) 12 gauge hinge rail available (Specify) Surface mounting (e.g. McKinney-21, 53)</p> <p>LOCK PREPARATIONS Cylindrical lock 1-3/4" door 161 Cylindrical lock 1-3/4" door lever trim (Universal lever trim prep) Deadlock 1 3/4" door tubular 181 Deadlock 1 3/4" door mortise 190 Interconnected lock</p>	<p>Factory Quoted</p> <p>Factory Quoted</p> <p>Factory Quoted</p> <p>Factory Quoted</p> <p>Factory Quoted</p>	<p>EXTRAS</p> <p>LOCK PREPARATIONS CONTINUED Mortise lock 1 3/4" door escutcheon trim Mortise lock 1 3/4" door sectional trim</p> <p>Hotel and master ring cylinder functions</p> <p>Mortise lock edge only preparation Mortise lock reinforce only Mortise panic exit Rim panic reinforce only Rim panic reinforce with function holes Rim vertical rod reinforce only Rim vertical rod with function holes Concealed vertical rods</p> <p>UNDERCUTS 1 3/4" doors-1/8" standard</p> <p>VISION KITS Vision kits installed- glass by others (specify glass thickness) 1/4" thick glass standard FV</p>	<p>Factory Quoted</p> <p>G3 G3A*</p> <p>G3AEO G3ARO G12* G11 G11* G11A G11A* G12A*</p> <p>Factory Quoted</p> <p>Factory Quoted</p>
---	--	--	---

FRM Series Frames - 14 Ga. Flood Resistant Flood Resistant Frame Prices

May, 2024



	WIDTH	HEIGHT	5 7/8 THRU 6	6-1/8 THRU 7-7/8	8 THRU 9-7/8	10 THRU 11-7/8	12 THRU 14	
SINGLES	2'0" THRU 3'0"	6'8"	FACTORY QUOTE ONLY at specialtypricing.curries@assaabloy.com For faster quote turnaround, please use the QQF (Quick Quote Forms) located on Connect					
		7'						

NOTE: This product is manufactured offsite and ships separately
Call to verify lead-times, freight cost, and ship schedule

GENERAL INFORMATION

CURRIES FRM series frames are available double rabbet. Prices will reflect hardware preparations for 1 3/4" doors. Refer to CURRIES Architectural Technical Data Manual for standard details and limitations.

2" face frames are standard. 1", 1 1/4", 1 1/2", & 1 3/4" face frames are available.

Jamb depth ranges are listed above each column. 1/8" increment jamb depths (all ranges 5 7/8" thru 14") are available.

ANCHORS - foot clips are welded in place
 Standard loose jamb anchors are included.
 3 per jamb up to 7'6". Complete anchor information is listed in the Engineered Frame Section

Welding charge only per anchor **Factory Quoted**
 (Add for appropriate anchor)

EXTRAS
BUNDLING AND TAGGING FRAMES **Factory Quoted**
 Frame Order Code 4F
 Welded Frames

FRM Series Frames - 14 Ga Flood Resistant Flood Resistant Frame Prices

May, 2024

<p style="text-align: center;">EXTRAS</p> <p>FOUR (4") INCH FACE HEADS JAMB DEPTH Factory Quoted Single including 4'0"</p> <p>GALVANNEAL (A60) NO ADD Factory Quoted</p> <p>GALVANIZED (G-90) Factory Quoted Price per 4 Sided frame Per member</p>	<p style="text-align: center;">EXTRAS</p> <p>CLOSER PREPARATIONS Factory Quoted Regular arm E10 Parallel arm E11</p> <p>HINGE PREPARATIONS Factory Quoted 3 1/2" 1 pair or 1 1/2 pair 4 1/2" standard or heavyweight 1 1/2 pair up to and including 7'6" 5" standard or heavyweight Full surface mounted continuous hinge reinforcement High frequency reinforcement strap support Per hinge</p> <p>HOLDERS Factory Quoted Overhead stop and holder surface mounted 14 ga</p> <p>PIVOTS Factory Quoted Top and bottom set single acting Per frame Per jamb Per head Intermediate pivot single acting Each</p> <p>PANIC EXIT REINFORCING Factory Quoted Rim type E8 Rim vertical rod surface mounted strike E5 Vertical rod mortise strike in head - Each G20</p> <p>STRIKES Factory Quoted 4 7/8" ANSI lipped strike 1 3/4" door E1 2 3/4" ANSI lipped strike 1 3/4" door E2 3 1/2" ANSI deadlock strike 1 3/4" door E3 2 3/4" ANSI deadlock strike 1 3/4" door E4 Electric strike frame E9 (includes cover box with knockout)</p>
---	---

FRM Series Frames - 12 Ga. Flood Resistant Flood Resistant Frame Prices

May, 2024



	WIDTH	HEIGHT	5 7/8 THRU 6	6-1/8 THRU 7 7/8	8 THRU 9 7/8	10 THRU 11-7/8	12 THRU 14	
SINGLES	2'0" THRU 3'0"	6'8"	FACTORY QUOTE ONLY at specialtypricing.curries@assaabloy.com For faster quote turnaround, please use the QQF (Quick Quote Forms) located on Connect					
		7'						

NOTE: This product is manufactured offsite and ships separately
Call to verify lead-times, freight cost, and ship schedule

GENERAL INFORMATION

CURRIES FRM series frames are available double rabbet. Prices will reflect hardware preparations for 1 3/4" doors. Refer to CURRIES Architectural Technical Data Manual for standard details and limitations.

2" face frames are standard. 1", 1 1/4", 1 1/2", & 1 3/4" face frames are available.

Jamb depth ranges are listed above each column. 1/8" increment jamb depths (all ranges 5 7/8" thru 14") are available.

ANCHORS - foot clips are welded in place

Standard loose jamb anchors are included in these prices. 3 per jamb up to 7'6". Complete anchor information is listed in the Engineered Frame Section

Welding charge only per anchor
 (Add for appropriate anchor)

Factory Quoted

EXTRAS

BUNDLING AND TAGGING FRAMES

Frame Order Code 4F
 Welded Frames

Factory Quoted

3F, 3FH, 3FV, 2F, 4

FRM Series Frames - 12 Ga Flood Resistant Flood Resistant Frame Prices

May, 2024

<p style="text-align: center;">EXTRAS</p> <p>Four (4") INCH FACE HEADS JAMB DEPTH Single including 4'0" Factory Quoted</p> <p>GALVANNEAL (A60) NO ADD Factory Quoted</p> <p>GALVANIZED (G-90) Factory Quoted</p>	<p style="text-align: center;">EXTRAS</p> <p>CLOSER PREPARATIONS Factory Quoted</p> <p>Regular arm E10</p> <p>Parallel arm E11</p> <p>HINGE PREPARATIONS Factory Quoted</p> <p>3 1/2" 1 pair or 1 1/2 pair</p> <p>4 1/2" standard or heavyweight</p> <p>1 1/2 pair up to and including 7'6"</p> <p>5" standard or heavyweight</p> <p>Full surface mounted continuous hinge reinforcement</p> <p>High frequency reinforcement strap support</p> <p>Per hinge</p> <p>HOLDERS Factory Quoted</p> <p>Overhead stop and holder surface mounted 14 ga</p> <p>PIVOTS Factory Quoted</p> <p>Top and bottom set single acting</p> <p>Intermediate pivot single acting</p> <p>PANIC EXIT REINFORCING Factory Quoted</p> <p>Rim type E8</p> <p>Rim vertical rod surface mounted strike E5</p> <p>Vertical rod mortise strike in head - Each G20</p> <p>STRIKES Factory Quoted</p> <p>4 7/8" ANSI lipped strike 1 3/4" door E1</p> <p>2 3/4" ANSI lipped strike 1 3/4" door E2</p> <p>3 1/2" ANSI deadlock strike 1 3/4" door E3</p> <p>2 3/4" ANSI deadlock strike 1 3/4" door E4</p> <p>Electric strike frame E9</p> <p>(includes cover box with knockout)</p>
---	---

867 Series Doors - Blast Resistant

May, 2024



WIDTH	HEIGHT	12 GA
		Factory Quoted

Submit quote to - SpecialtyPricing.Curries@assaabloy.com

For faster quote turnaround, please use the QQF (Quick Quote Forms) located on Connect.

Door tested per DoD UFC 4-010.01

Door tested per PIPSTC01018

Door tested per VA Life Safety and Mission Critical

Single and pairs available.

Available up to 100 psi +

**NOTE: This product is manufactured offsite and ships separately
Call to verify lead-times, freight cost, and ship schedule**

STANDARD DESCRIPTION

Proprietary core construction. Continuous welded "T" edge is standard
1-3/4" Thick Doors

EDGE BEVELS AVAILABLE

Factory Quoted

"A" standard (1/8" in 2" lock edge-square hinge edge)

OPTIONS

Factory Quoted

Galvanneal steel (A60)

Galvanized (G90) includes epoxy primer

LISTED FIRE LABEL DOORS - Available

VISION KITS - Available

Factory Quoted

Factory Installed Glass

EXTRAS

CAPS - top and bottom

Factory Quoted

CLOSER

Factory Quoted

Surface mounted, reinforcement only

UNDERCUTS

Factory Quoted

1 3/4" doors-3/4" standard

	WIDTH	HEIGHT	5 3/4 THRU 6	6-1/8 THRU 7-7/8	8 THRU 9-7/8	10 THRU 11-7/8	12 THRU 14
SINGLES	Factory Quoted Only						

Submit quote to -

SpecialtyPricing.Curries@assaabloy.com

For faster quote turnaround, please use the QQF (Quick Quote Forms) located on Connect.

GENERAL INFORMATION

CURRIES series frames are available double rabbet, equal or unequal, Prices will reflect hardware preparations for Blast Resistant door and frame assembly. Refer to CURRIES Architectural Technical Data Manual for standard details and limitations.

NOTE: 5-3/4" jamb depth frames have 1/2" minimum back bend. 7/16" N.A.

2" face frames are standard.

Jamb depth ranges are listed above each column.

1/8" increment jamb depths (all ranges 5 3/4" thru 14") are available.

Frame tested per DoD UFC 4-010.01

Frame tested per PIPSTC01018

Frame tested per VA Life Safety and Mission Critical

Single and pairs available.

Available up to 100 psi +

ANCHORS - existing opening

OPTIONS

Factory Quoted

Galvanneal steel (A60) per 3 sided frame

Galvanized (G90) per 3 sided frame

EXTRAS

BUNDLING AND TAGGING FRAMES

Factory Quoted

Frame Order Code 3F, 3FH, 3FV, 2F, SL, BL, and 4F

**NOTE: This product is manufactured offsite and ships separately
 Call to verify lead-times, freight cost, and ship schedule**

CLOSER REINFORCEMENT

Factory Quoted

FOUR (4") INCH FACE HEAD

Factory Quoted

FIRE RATING

Factory Quoted

DESCRIPTION	GAUGE	PAGE
Windstorm Doors and Frames		
Hurricane-Resistant General Notes		WS-1
Door Construction Adds		WS-2-3
Doors		
607S Series — Polystyrene Core	18	WS-4-5
707S Embossed Panel	18, 16	WS-6-7
707S Series — Polystyrene Core	18, 16, 14	WS-8-9
727S Series — Temperature Rise 250°F & 450°F	16	WS-10-11
747S Series — Steel Stiffened	18, 16, 14	WS-12-13
777SE Series — Trio-E Steel Stiffened Polyurethane Filled	18, 16	WS-14-15
Frames		
KD 16, 14, and 12 — Masonry Flush Frames and Components		WS-16-17
CCW		
Estimating CCW per Foot — M-16 gauge	16	
Borrowed Light		WS-19
Borrowed Light with Fire Rated Impact Glass		WS-19
Transom or Sidelight		WS-20
Estimating CCW per Foot — M-14 gauge	14	
Borrowed Light		WS-21
Transom or Sidelight		WS-22
707S CURRIStain Six Panel Door	18	WS-23
Hurricane -Resistant 150 PSF Door		
M-14 KD Frame		WS-24
Hurricane Glazing		
StormPro 361® Multi-Point Lock Assembly - Door	14	WS-27
M-14 KD Frame		
StormPro 361® Multi-Point Lock Assembly - Door	12	WS-28
M-12 KD Frame		
StormPro 320 Assembly - 747 Series Doors - Steel Stiffened	14	WS-29
M-14 KD Frame		
StormPro Assembly Doors	14	WS-30
M-14 KD Frame		
StormPro Assembly Doors	12	WS-31
M-12 KD Frame		
StormPro Shutter Door and Frame	14	WS-32
StormPro Shutter Door and Frame	12	WS-33



WS-1
Hurricane Resistant - General Notes
Windstorm Prices

May, 2024

Borrowed Lights - max glass size or 1-3/4 panel size 36"x94" per light opening.

Panels needs to be 16 gauge 707 (polystyrene or urethane) or 747. 747 require 20 ga. stiffeners. Panels priced from Engineered Section.

All borrowed lights, transoms or sidelights must be factory or regional service center welded unless 2nd location approval.

Storefront maximum, three foot maximum between vertical members. Overall width of the frame is indefinite if not fire rated.

WS-2
Hurricane-Resistant Door Construction Adds
Windstorm Prices

May, 2024



CURRIES Hurricane-Resistant Doors Construction Adds
This page is for Construction Adds only.
You will find your base price and additional hardware adds on page 6-19.

					LIST PRICE ADD	
DESIGN PRESSURE	ACCEPTANCE/ APPROVAL #	MAXIMUM SIZE SINGLE/PAIR	DOOR SERIES	HARDWARE TYPE	SINGLE/ACTIVE LEAF OF PAIRS	INACTIVE LEAF OF PAIRS
57.2**	FL8394.7-UL	4070 Single	747 Flush only	SA HC8800 Rim Exit Device	No Add	N/A
60	FL11537-UL FL16353	3070 Single	607, 707, 727, 747, CURRIStain	Cyl Lock, Mortise Lock, Mortise Exit, Rim Exit	No Add	N/A
60	FL11537-UL FL16353	3080 Single 6080 Pairs	707, 727, 747, CURRIStain	Exit Devices or Mortise Locks w/ Latchbolt and Deadbolt (Inactive Leaf requires Surface Bolt)	\$341	\$341
60	FL8394.1-UL	6070 Pairs	707, Embossed, CURRIStain, Flush only	SA 8200 Mortise w/ Deadbolt function	\$42	\$287
60***	FL16353	4080 Single 8080 Pair	707, 727, 747	Exit Devices	\$607	\$620
60***	FL16353	4080 Single 8080 Pair	707, 727, 747	Mortise Locks w/Latchbolt and Deadbolt (Inactive Leaf requires Surface Bolt)	\$717	\$737
62**	FL8394.8-UL	8080 Pair	747 Flush only	SA HC8700 SVR Exit Device	No Add	No Add
70	FL8768-WH FL11537-UL	4080 Single 8080 Pair	707, 727, 747	Exit Devices	\$607	\$620
70	FL8768-WH FL11537-UL FL16353	4080 Single 8080 Pair	707, 727, 747	Mortise Locks w/ Latchbolt and Deadbolt (Inactive Leaf requires Surface Bolt)	\$717	\$737
70	FL8768-WH FL11537-UL FL16353	3070 Single	607, 707, 727, 747, CURRIStain	Cyl Lock, Cyl dead bolt, Mortise lock with Latchbolt and Deadbolt, Interconnected locks	No Add	N/A
70	FL11537-UL FL16353	6070 Pairs	707, 727, 747, 777, Note: Flush only	Mortise locks w/ latchbolt and Deadbolt (Inactive requires Flush Bolt)	\$382	\$680
70	FL8770.1-WH FL8770.3-WH	4080 Single	707, 727, 747	Positive Lock hardware, ASSA ABLOY LV-WS Louver (previously Markar WLV60)	\$341	N/A
70	FL8770.2-WH FL8770.4-WH	3070 Single	707, 747, CURRIStain	Positive Lock hardware, ASSA ABLOY LV-WS Louver (previously Markar WLV60)	No Add	N/A
72	FL8394.6-UL	3070 Single	707, Embossed, CURRIStain	Schlage D Series Cyl lock or SA 8200 Mortise Lock	\$44	N/A
80**	FL8394.3-UL	3070 Single	707, Embossed, CURRIStain, Flush only	Sargent 8900 Mortise Exit Device	\$44	N/A

CURRIES Hurricane-Resistant Doors Construction Adds
This page is for Construction Adds only.
You will find your base price and additional hardware adds on page 6-19.

					LIST PRICE ADD	
DESIGN PRESSURE	ACCEPTANCE/ APPROVAL #	MAXIMUM SIZE SINGLE/PAIR	DOOR SERIES	HARDWARE TYPE	SINGLE/ACTIVE LEAF OF PAIRS	INACTIVE LEAF OF PAIRS
85**	FL8394.4-UL	3070 Single	707, Embossed, CURRIStain, Flush only	Sargent 6500 Cyl Lock	\$44	N/A
100	FL11537-UL FL16353	3070 Single	707, 727, 747, 777, 777E, Embossed, CURRIStain, Flush only	Cyl Lock, Mortise Lock with Latchbolt and Deadbolt, Rim Exit	\$44	N/A
100**	FL8394.5-UL	3070 Single	707, Embossed, CURRIStain, Flush only	SA 8200 Mortise w/ Deadbolt function	\$44	N/A
115	FL11537-UL FL8768-WH FL16353	3070	707, 727, 747, Embossed, CURRIStain, 757 (STC 46 only)	Mortise Locks w/ Latchbolt and Deadbolt, Exit Devices	\$44	N/A
150 50 FPS	FL11537-UL FL16353	4080 Single 8080 Pair	707, 747	SA HC48700	\$364	\$547
150	FL11537-UL FL16353	4080 Single 8080 Pair	707	Corbin Russwin FE6600, Sargent FM7300	\$4,442	\$4,536
150 80 FPS	FL32087	4080 Single 8080 Pair	707, 747	Sargent HC4-8700 SVR active, Sargent HC4-8700 x Sargent 988	\$1,003	\$1,003
NOTES		<p>1) Approved hardware available on partner area of www.curries.com. Click on "Hurricane-Resistant Guide" in Hurricane-Resistant section.</p> <p>2) Doors over 3070 and pairs available in 16 and 14 ga. only (Use 16 and 14 ga base door price).</p> <p>3) List price add includes construction upgrades only for windstorm resistance.</p> <p>4) Doors, frame, and hardware certified to: TAS 201, 202, 203, ASTM E330, E1886, E1996, ANSI A250.13 except where noted.</p> <p>5) Door with Multi-Lock prep - Corbin Russwin FE6600 or Sargent FM7300 Vertical rods, top and bottom bolts, and mortise lock body cassette factory installed.</p> <p>** Not Certified to ANSI A250.13</p>				

WS-4 607S Series Doors - Polystyrene Core Hurricane-Resistant Door Prices

May, 2024



WIDTH	HEIGHT	18 GAUGE			
20,24 26,28 210, 30	68	\$667			
20,24 26,28 210, 30	70	\$708			

CONSTRUCTION ADDS

See preface (page WS-2 & WS-3)

607 doors exclude electrified hardware and interconnected locks.

See Hurricane-Resistant Guide in partner area of www.curries.com for available hardware.

STANDARD DESCRIPTION

Cold rolled steel 18 gauge
Polystyrene core, exposed seam "S" edge only.
1 3/4" thick doors.
Limited hardware preparations.

EDGE BEVELS AVAILABLE

"B" square both edges/non handed — No Charge

OPTIONS

Galvaneal steel (A60) – Not available

Visual ID tag Add \$6

LISTED FIRE LABEL DOORS

Label door restrictions per gauge and size can be determined in the current CURRIES product brochure. Prices are without closers (CL)

		Less CL
Underwriters Laboratories	ABCG	Add \$65
Warnock Hersey	ABCG	Add \$17
20 minute U.L. or W.H.I.		Add \$17
Label construction		Add \$24

PAIRS: Not Available

HURRICANE CODE LABEL

Warnock Hersey H (component) Add \$15

Underwriters Laboratory H (component) Add \$15

NON STANDARD SIZE DOORS – NOT AVAILABLE

(Standard sizes are published on this page)

**607S Series Doors - Polystyrene Core
Hurricane-Resistant Door Prices**

May, 2024

EXTRAS

CAPS — top or bottom

Steel installed flush (with screws per cap)

Add \$26

CLOSER

Surface mounted, reinforcement only

Add \$36

HINGE PREPARATIONS

4 1/2" (non handed)

Standard

LOCK PREPARATIONS

Cylindrical lock 1 3/4" door 161

G2 Standard

Cylindrical lock 1 3/4" door lever trim

G2B Standard

(Universal lever trim prep)

EXTRAS

LOCK PREPARATIONS CONTINUED

Mortise lock 1 3/4" door escutcheon trim

G3 Standard

Mortise lock edge only preparation

G3AEO Standard

Rim panic reinforce only

G11 Add \$46

LOUVERS

Preparation or installation is not available in the 607 series.

UNDERCUTS

1 3/4" doors — 3/8" and 5/8" only

No Add

VISION KITS

Preparation or installation is not available in the 607 series.

WS-6
707S Embossed Panel 18-16
Hurricane-Resistant Door Prices

May, 2024



WIDTH	HEIGHT	E6 18 CRS
28	68	\$989
210		
30		
28	70	\$1,014
210		
30		

WIDTH	HEIGHT	E6 18 GALV	E6 16 GALV
28	68	\$1,086	\$1,209
210			
30			
28	70	\$1,117	\$1,249
210			
30			

3070 is maximum for E6 doors.

STANDARD DESCRIPTION

Cold Rolled Steel (CRS) 18 gauge steel
 Galvanneal (A60) steel 18 or 16 gauge steel.

Polystyrene core
 "S" exposed edge seam 1 3/4" thick doors only.

EDGE BEVELS AVAILABLE

"A" Specify (required for some hardware)
 1/8" in 2" lock edge-square hinge edge No Add
 "G" Specify (1/8" in 2" bevel both edges) Add \$18

EDGE OPTIONS

"N" Seamless edge filled Add \$89
 "T" - not available
 Visual ID tag Add \$6

LISTED FIRE LABEL DOORS

Label door restrictions per gauge and size can be determined in the General Information Section. Prices are without closers (CL).

			Less CL
Underwriters Laboratories	ABCG	Add	\$65
Warnock Hersey	ABCG	Add	\$17
20 minute U.L. or W.H.I.		Add	\$17
Label construction		Add	\$24

HURRICANE CODE LABEL

Warnock Hersey H Component Add \$15
 Underwriters Laboratory X Assembly Add \$15
 Underwriters Laboratory H Component Add \$15

**NON STANDARD SIZE DOORS- CONTACT FACTORY OVERSIZED DOOR
 OPTIONS-NOT AVAILABLE**

CONSTRUCTION ADDS

See preface (page WS-2 & WS-3)
 See Hurricane-Resistant Guide in partner area of www.curries.com for available hardware.



ASSA ABLOY

WS-7

**707S Embossed Panel
Hurricane-Resistant Door Prices**

May, 2024

EXTRAS

CAPS—top or bottom

Steel installed flush (with screws per cap) Add \$26

CLOSER

Surface mounted reinforcement only Add \$36

HINGE PREPARATIONS

4 1/2" standard, heavyweight, or Ultima Standard

Standard 5" Hinge standard or heavyweight Add Ea. \$9

Continuous hinge preparation(mounting holes field drilled)

Concealed mounting + (e.g. McKinney - 11, 24)

12 gauge hinge rail standard (Specify) No Add

+ non standard door size charge applied to less than

13 special size doors per order; 13 or more no add.

LOCK PREPARATIONS

Cylindrical 161 G2 Standard

Cylindrical lock - Lever trim holes G2B Standard

(Universal lever trim prep)

*Deadlock - Tubular 181 G16 Standard

Interconnected lock G25 Add \$58

* Approved deadlock must be used with qualified cylindrical lockon +/-70 single opening

EXTRAS

LOCK PREPARATIONS CONTINUED

Mortise lock 1 3/4" door escutcheon trim G3A Standard

Mortise lock 1 3/4" door sectional trim G3A Standard

Hotel and master ring cylinder functions Standard

Mortise lock edge only preparation G3AEO Standard

Rim panic reinforce only G11 Add \$46

Rim panic reinforce with function holes G11 Add \$46

UNDERCUTS

1 3/4" doors – 5/8" standard

3/8" and 3/4" available

3/8" required for concealed or surface vertical rods No Add

All other undercuts per door Add \$24

WS-8
707S Series Doors - Polystyrene Core
Hurricane-Resistant Door Prices

May, 2024



WIDTH	HEIGHT	18 GAUGE	16 GAUGE	14 GAUGE
20, 24				
26,28				
210, 30	68	\$757	\$880	\$1,156
34,36	68	\$953	\$1,078	\$1,355
38, 310				
40	68	\$1,062	\$1,186	\$1,461
20, 24				
26,28				
210	70	\$782	\$914	\$1,210
30				
34,36	70	NA	\$1,111	\$1,398
38, 310				
40	70	NA	\$1,232	\$1,519
20, 24				
26,28				
210	72	NA	\$1,016	\$1,333
30				
34,36	72	NA	\$1,196	\$1,514
38, 310				
40	72	NA	\$1,308	\$1,624
30	80	NA	\$1,185	\$1,505
34, 36	80	NA	\$1,346	\$1,673
38, 310, 40	80	NA	\$1,445	\$1,770

NON STANDARD SIZE DOORS

Price as the next largest standard size door

CONSTRUCTION ADDS

See preface (page WS-2 & WS-3)

CURRIStain flush door prices (see page 10 & 11 of door section)

See Hurricane-Resistant Guide in partner area of www.curries.com for available hardware.

STANDARD DESCRIPTION

Polystyrene core with an "A" edge bevel and exposed seam "S" edge are standard

1-3/4" thick doors.

EDGE BEVELS AVAILABLE

"A" standard(1/8" in 2" lock edge - square hinge edge) No Add
 "G" Specify (1/8" in 2" bevel both edges) Add \$18

Galvanneal Steel (A40 & A60)

	A40	A60
a) 68 HEIGHT	Add \$48	\$97
b) 70 HEIGHT	Add \$48	\$103
c) 72 HEIGHT	Add \$48	\$111
d) 80 HEIGHT	Add \$48	\$118

Galvanize (G90)

a) 68 HEIGHT	Add	\$354
b) 70 HEIGHT	Add	\$361
c) 72 HEIGHT	Add	\$367
d) 80 HEIGHT	Add	\$373

"N" Seamless edge filled Add \$89

"T" Continuous wire welded Add \$143

MAX thermally enhanced core (UL label only) Add \$148

Visual ID tag Add \$6

LISTED FIRE LABEL DOORS

Label door restrictions per gauge and size can be determined in the General Information Section. Prices are without closers (CL).

Underwriters Laboratories	ABCG	Add	\$65
Warnock Hersey	ABCG	Add	\$17
20 minute U.L. or W.H.I.		Add	\$17
Label construction		Add	\$24

HURRICANE CODE LABEL Warnock Hersey H Component

Warnock Hersey H Component	Add	\$15
Dade County D	Add	\$15
Underwriters Laboratory X Assembly	Add	\$15
Underwriters Laboratory H Component	Add	\$15

EXTRAS

CAPS — top or bottom			
Steel installed flush (with screws per cap)	Add	\$26	
CLOSER			
Surface mounted, reinforcement only	Add	\$36	
HINGE PREPARATIONS			
4 1/2" standard, heavyweight, or Ultima	Standard		
1 1/2 pair up to and including 7'6"	Standard		
2 pair over 7'6" to 8'0"	Standard		
5" Hinge standard or heavyweight	Add Each	\$9	
Continuous hinge preparation(mounting holes field drilled)			
Concealed mounting *			
(e.g. McKinney - 11, 24)			
12 gauge hinge rail standard (Specify)	No Add		

* Non standard door size charge applied to less than 13 special size doors per order; 13 or more no add.

LOCK PREPARATIONS

Cylindrical lock 1 3/4" door 161	G2B*	Standard	
Cylindrical lock 1 3/4" door lever trim (Universal lever trim prep.)	G2B*	Standard	
Deadlock 1 3/4" door tubular 181	G16	Standard	
Interconnected lock	G25	Add	\$58

*** APPROVED DEADLOCK MUST BE USED WITH QUALIFIED CYLINDRICAL LOCK ON +/-70 SINGLE OPENING**

Mortise lock 1 3/4" door escutcheon trim	G3	Standard	
Mortise lock 1 3/4" door sectional trim	G3A	Standard	
Hotel and master ring cylinder functions		Standard	
Mortise lock edge only preparation	G3AEO	Standard	
Mortise panic exit	G12	Add	\$87
Rim panic reinforce only	G11	Add	\$46
Rim panic reinforce with function holes	G11	Add	\$46
Rim vertical rod reinforce only	G11A	Add	\$87
Rim vertical rod with function holes	G11A	Add	\$87
Concealed vertical rods	G12A	Add	\$578

EXTRAS
LOUVERS-NOT AVAILABLE FIRE LABEL

12" x 12"	Add	\$605
12" x 24"	Add	\$776
18" x 18"	Add	\$776
24" x 24"	Add	\$924
22" x 60"	Add	\$1,980
20" x 64"	Add	\$2,020
24" x 60"	Add	\$2,020
24" x 64"	Add	\$2,110
Louver cutout only with surround channel*	Add	\$236

* Louvers must be factory installed or by a UL or Warnock Windstorm second location.

SURFACE BOLTS

SB Add \$61

STRIKES

4 7/8" ANSI lipped strike 1 3/4" door	E1	Add	\$63
2 3/4" ANSI lipped strike 1 3/4" door	E2	Add	\$63
* 3 1/2" ANSI deadlock strike	E3	Add	\$63
*2 3/4" ANSI deadlock strike	E4	Add	\$63
Electronic raceway		Add	\$166

UNDERCUTS

1 3/4" doors - 5/8" standard		
3/8" and 3/4" available	No Add	
3/8" required for concealed or surface vertical rods		
3/8" required for Dade county		
All other undercuts per door	Add	\$24

VISION KITS - Type 1 - Not Fire Rated

Vision kits installed - (3/8" pocket) Glass by others		
Includes 14 ga. Surround channel		
FV	Add	\$396
FNV	Add	\$423
HG +/-70	Add	\$466
FG +/-60 (24x66) Type 2	Add	\$707
3/8" pocket for polycarbonate - use type 1 or 3.		
5/8" pocket for glasslam - use type 2.		

WIDTH	HEIGHT	16 GAUGE
20, 24 26,28 210 30	68	\$1,626
34,36	68	\$1,829
38, 310 40	68	\$1,920
20, 24 26,28 210 30	70	\$1,660
34,36	70	\$1,866
38, 310 40	70	\$1,962
20, 24 26,28 210 30	72	\$1,728
34,36	72	\$1,910
38, 310 40	72	\$2,000
30	80	\$2,110
34, 36	80	\$2,257
38, 310, 40	80	\$2,360

STANDARD DESCRIPTION

Composite core with an "A" edge bevel and exposed seam "S" edge are standard.
 1 3/4" thick doors.
 250° or 450° rating available. Price is the same, specify rating when ordering.

EDGE BEVELS AVAILABLE

"A" standard(1/8" in 2" lock edge - square hinge edge) No Add
 "G" Specify (1/8" in 2" bevel both edges) Add \$18

OPTIONS

Galvanneal Steel (A40 & A60)

	A40	A60
a) 68 HEIGHT	Add \$48	\$97
b) 70 HEIGHT	Add \$48	\$103
c) 72 HEIGHT	Add \$48	\$111
d) 80 HEIGHT	Add \$48	\$118

Galvanize (G90)

a) 68 HEIGHT	Add \$354
b) 70 HEIGHT	Add \$361
c) 72 HEIGHT	Add \$367
d) 80 HEIGHT	Add \$373

"N" Seamless edge filled Add \$89
 "T" Continuous wire welded Add \$143
 Visual ID tag Add \$6

LISTED FIRE LABEL DOORS

Label door restrictions per gauge and size can be determined in the General Information Section.
 Prices are without closers (CL).

NON STANDARD SIZE DOORS

Price as the next largest standard size door

CONSTRUCTION ADDS

See preface (page WS-2 & WS-3)
 CURRIStain flush door prices (see page 12 & 13 of door section)
 See Hurricane-Resistant Guide in partner area of www.curries.com
 for available hardware.

Underwriters Laboratories	ABC	Add	Less CL \$65
Warnock Hersey	ABC	Add	\$17
Label construction		Add	\$24

HURRICANE CODE LABEL

Warnock Hersey H Component	Add	\$15
Underwriters Laboratory X Assembly	Add	\$15
Underwriters Laboratory H Component	Add	\$15

EXTRAS
CAPS — top or bottom

Steel installed flush (with screws per cap) Add \$26

CLOSER

Surface mounted, reinforcement only Add \$36

HINGE PREPARATIONS

4 1/2" standard, heavyweight, or Ultima Standard

1 1/2 pair up to and including 7'6" Standard

2 pair over 7'6" to 8'0" Standard

 5" Hinge standard or heavyweight 1-1/2 pr. Add \$9
Each

Continuous hinge preparation(mounting holes field drilled)

 Concealed mounting +
(e.g. McKinney - 11, 24)

12 gauge hinge rail standard (Specify) No Add

 + non standard door size charge applied to less than
13 special size doors per order; 13 or more no add.

LOCK PREPARATIONS

Cylindrical lock 1 3/4" door 161 G2 Standard

 Cylindrical lock 1 3/4" door lever trim G2B* Standard
(Universal lever trim prep.)

*Deadlock 1 3/4" door tubular 181 G16 Standard

Interconnected lock G25 Add \$58

*** APPROVED DEADLOCK MUST BE USED WITH QUALIFIED
CYLINDRICAL LOCK ON +/-70 SINGLE OPENING**
EXTRA
LOCK PREPARATIONS CONTINUED

Mortise lock 1 3/4" door escutcheon trim G3 Standard

Mortise lock 1 3/4" door sectional trim G3A Standard

Hotel and master ring cylinder functions Standard

Mortise lock edge only preparation G3AEO Standard

Mortise panic exit G12 Add \$87

Rim panic reinforce only G11 Add \$46

Rim panic reinforce with function holes G11 Add \$46

Rim vertical rod reinforce only G11A Add \$87

Rim vertical rod with function holes G11A Add \$87

Concealed vertical rods G12A Add \$578

SURFACE BOLTS

SB Add \$61

STRIKES

4 7/8" ANSI lipped strike 1 3/4" door E1 Add \$63

2 3/4" ANSI lipped strike 1 3/4" E2 Add \$63

*3 1/2" ANSI deadlock strike E3 Add \$63

*2 3/4" ANSI deadlock strike E4 Add \$63

Electric raceway Add \$166

UNDERCUTS

1 3/4" doors – 5/8" standard

3/8" and 3/4" available No Add

3/8" required for concealed or surface vertical rods

3/8" required for Dade county

All other undercuts per door Add \$24

WS-12
747S Series Doors - Steel Stiffened
Hurricane-Resistant Door Prices

May, 2024



WIDTH	HEIGHT	18 GAUGE	16 GAUGE	14 GAUGE
20, 24 26,28 210 30	68	\$937	\$1,080	\$1,389
34,36	68	\$1,151	\$1,296	\$1,606
38, 310 40	68	\$1,278	\$1,424	\$1,734
20, 24 26,28 210 30	70	\$953	\$1,107	\$1,438
34,36	70	NA	\$1,340	\$1,672
38, 310 40	70	NA	\$1,480	\$1,812
20, 24 26,28 210 30	72	NA	\$1,194	\$1,547
34,36	72	NA	\$1,396	\$1,752
38, 310 40	72	NA	\$1,528	\$1,886
30	80	NA	\$1,467	\$1,843
34, 36	80	NA	\$1,657	\$2,036
38, 310, 40	80	NA	\$1,782	\$2,161

NON STANDARD SIZE DOORS

Price as the next largest standard size door

CONSTRUCTION ADDS

See preface (page WS-2 & WS-3)

See Hurricane-Resistant Guide in partner area of www.curries.com for available hardware.

STANDARD DESCRIPTION

Steel stiffened core with an "A" edge bevel and exposed seam "S" edge are standard.

1 3/4" thick doors with 22 gauge stiffeners.

EDGE BEVELS AVAILABLE

"A" standard(1/8" in 2" lock edge - square hinge edge) No Add
 "G" Specify (1/8" in 2" bevel both edges) Add \$18

OPTIONS

Galvanneal Steel (A40 & A60)

		<u>A40</u>	<u>A60</u>
a) 68 HEIGHT	Add	\$48	\$97
b) 70 HEIGHT	Add	\$48	\$103
c) 72 HEIGHT	Add	\$48	\$111
d) 80 HEIGHT	Add	\$48	\$118

Galvanize (G90)

a) 68 HEIGHT	Add	\$354
b) 70 HEIGHT	Add	\$361
c) 72 HEIGHT	Add	\$367
d) 80 HEIGHT	Add	\$373

"N" Seamless edge filled Add \$89

"T" Continuous wire welded Add \$143

Visual ID tag Add \$6

LISTED FIRE LABEL DOORS

Label door restrictions per gauge and size can be determined in the General Information Section. Prices are without closers (CL).

			<u>Less CL</u>
Underwriters Laboratories	ABCG	Add	\$65
Warnock Hersey	ABCG	Add	\$17
20 minute U.L. or W.H.I.		Add	\$17
Label construction		Add	\$24

HURRICANE CODE LABEL

Warnock Hersey H Component	Add	\$15
Dade County D	Add	\$15
Underwriters Laboratory X Assembly	Add	\$15
Underwriters Laboratory H Component	Add	\$15

EXTRAS

CAPS — top or bottom			
Steel installed flush (with screws per cap)		Add	\$26
CLOSER			
Surface mounted, reinforcement only		Add	\$36
HINGE PREPARATIONS			
4 1/2" standard, heavyweight, or Ultima		Standard	
1 1/2 pair up to and including 7'6"		Standard	
2 pair over 7'6" to 8'0"		Standard	
5" Hinge standard or heavyweight		Add Ea	\$9
Continuous hinge preparation(mounting holes field drilled)			
Concealed mounting +			
12 gauge hinge rail standard (Specify)		No Add	

+ non standard door size charge applied to less than 13 special size doors per order; 13 or more no add.

LOCK PREPARATIONS

Cylindrical lock 1 3/4" door 161	G2	Standard	
Cylindrical lock 1 3/4" door lever trim (Universal lever trim prep.)	G2B*	Standard	
*Deadlock 1 3/4" door tubular 181	G16	Standard	
Interconnected lock	G25	Add	\$58

*** APPROVED DEADLOCK MUST BE USED WITH QUALIFIED CYLINDRICAL LOCK ON +/-70 SINGLE OPENING**

Mortise lock 1 3/4" door escutcheon trim	G3	Standard	
Mortise lock 1 3/4" door sectional trim	G3A	Standard	
Hotel and master ring cylinder functions		Standard	
Mortise lock edge only preparation	G3AEO	Standard	
Mortise panic exit	G12	Add	\$87
Rim panic reinforce only	G11	Add	\$46
Rim panic reinforce with function holes	G11	Add	\$46
Rim vertical rod reinforce only	G11A	Add	\$87
Rim vertical rod with function holes	G11A	Add	\$87
Concealed vertical rods	G12A	Add	\$578

EXTRAS

LOUVERS - Not available fire label			
12" x 12"		Add	\$605
12" x 24"		Add	\$776
18" x 18"		Add	\$776
18" x 24"		Add	\$691
24" x 24"		Add	\$924
22" x 60"		Add	\$1,980
20" x 64"		Add	\$2,020
24" x 60"		Add	\$2,020
24" x 64"		Add	\$2,110
Louver cutout only with surround channel*		Add	\$236

* Louvers must be factory installed or by a UL or Warnock Windstorm second location.

SURFACE BOLTS	SB	Add	\$61
----------------------	----	-----	------

STRIKES

4 7/8" ANSI lipped strike 1 3/4" door	E1	Add	\$63
2 3/4" ANSI lipped strike 1 3/4"	E2	Add	\$63
*3 1/2" ANSI deadlock strike	E3	Add	\$63
*2 3/4" ANSI deadlock strike	E4	Add	\$63
Electric raceway		Add	\$166

UNDERCUTS

1 3/4" doors – 5/8" standard	No Add		
3/8" and 3/4" available			
All other undercuts per door	Add	\$24	

VISION KITS — Type 1 - Not Fire Rated

Vision kits installed . Glass by others.			
Includes 14 ga. surround channel.			
FV		Add	\$396
FNV		Add	\$423
HG +/-70		Add	\$466
FG +/-60 (24 x 66) Type 2		Add	\$707

3/8" pocket for polycarbonate - use type 1 or 3.

5/8" pocket for glasslam - use type 2 or 3.

WIDTH	HEIGHT		18 GAUGE	16 GAUGE
20, 24 26,28 210 30	68		\$1,153	\$1,283
34,36	68		\$1,338	\$1,467
38, 310 40	68		\$1,451	\$1,580
20, 24 26,28 210 30	70		\$1,175	\$1,312
34,36	70		\$1,370	\$1,506
38, 310 40	70		\$1,489	\$1,627
20, 24 26,28 210 30	72		\$1,257	\$1,402
34,36	72		\$1,409	\$1,554
38, 310 40	72		\$1,520	\$1,666
20, 24 26,28 30	80		\$1,510	\$1,665
34, 36	80		\$1,657	\$1,811
38, 310, 40	80		\$1,770	\$1,924

STANDARD DESCRIPTION

Steel stiffened core filled with Polyurethane foam with an "A" edge bevel and exposed seam "S" edge are standard.
1 3/4" thick doors with 22 gauge stiffeners welded to core plate.

EDGE BEVELS AVAILABLE

"A" standard(1/8" in 2" lock edge - square hinge edge) No Add

OPTIONS

Galvanneal Steel (A40 & A60)

		<u>A40</u>	<u>A60</u>
a) 68 HEIGHT	Add	\$48	\$97
b) 70 HEIGHT	Add	\$48	\$103
c) 72 HEIGHT	Add	\$48	\$111
d) 80 HEIGHT	Add	\$48	\$118

Galvanize (G90)

a) 68 HEIGHT	Add	\$354
b) 70 HEIGHT	Add	\$361
c) 72 HEIGHT	Add	\$367
d) 80 HEIGHT	Add	\$373

"N" Seamless edge filled	Add	\$89
"T" Continuous wire welded	Add	\$143
Visual ID tag	Add	\$6

LISTED FIRE LABEL DOORS

Label door restrictions per gauge and size can be determined in the General Information Section. Prices are without closers (CL).

			Less CL
Underwriters Laboratories	ABCG	Add	\$65
Warnock Hersey	ABCG	Add	\$17
20 minute U.L. or W.H.I.		Add	\$17
Label construction		Add	\$24

HURRICANE CODE LABEL

Warnock Hersey H Component	Add	\$15
Underwriters Laboratory H Component	Add	\$15

NON STANDARD SIZE DOORS

Price as the next largest standard size door

CONSTRUCTION ADDS

See preface (page WS-2 & WS-3)

See Hurricane-Resistant Guide in partner area of www.curries.com for available hardware.



ASSA ABLOY

WS-15

777SE Series Doors

Hurricane-Resistant Door Prices

May, 2024

EXTRAS

CAPS — top or bottom
Steel installed flush (with screws per cap)

CLOSER

Surface mounted, reinforcement only Add \$36

HINGE PREPARATIONS

- 4 1/2" standard, heavyweight, or Ultima Standard
- 1 1/2 pair up to and including 7'6" Standard
- 2 pair over 7'6" to 8'0" Standard
- 5" Hinge standard or heavyweight Add Ea. \$9
- Continuous hinge preparation (mounting holes field drilled)
- Concealed mounting +
(e.g. McKinney - 11, 24)

+ non standard door size charge applied to less than 13 special size doors per order; 13 or more no add.

LOCK PREPARATIONS

- Cylindrical lock 1 3/4" door 161 G2 Standard
- Cylindrical lock 1 3/4" door lever trim (Universal lever trim prep.) G2B* Standard
- *Deadlock 1 3/4" door tubular 181 G16 Standard

*** APPROVED DEADLOCK MUST BE USED WITH QUALIFIED CYLINDRICAL LOCK ON SINGLE OPENING**

- Mortise lock 1 3/4" door escutcheon trim G3 Standard
- Mortise lock 1 3/4" door sectional trim G3AEO Standard
- Hotel and master ring cylinder functions Standard
- Mortise lock edge only preparation G3AEO Standard
- Rim panic reinforce only G11 Add \$46
- Rim panic reinforce with function holes G11 Add \$46
- Vertical rod exit (surface) edge prep G14B Add \$195

EXTRAS

UNDERCUTS

- 1 3/4" doors – 5/8" standard
- 3/8" and 3/4" available No Add
- All other undercuts per door Add \$24

VISION KITS - TYPE 2 - NOT FIRE-RATED

- Vision kits installed glass by others.
- Price includes 14 ga. channel surround.
- FV +/-70 psf Add \$515
- FNV +/-70 psf Add \$542
- HG +/-70 psf Add \$585

WS-16
KD Frames

Hurricane-Resistant Frame Prices

May, 2024



M-16 KD FRAMES

	WIDTH	HEIGHT	5-3/4 THRU 6	6-1/8 THRU 7-7/8	8 THRU 9-7/8	10 THRU 11-7/8	12 THRU 14
SINGLES	1'6" THRU 3'0"	6'8"	294	330	377	432	488
		7'	297	334	381	435	492
		7'2"	317	353	399	453	508
		8'	355	391	438	494	548
	3' + THRU 4'0"	6'8"	307	340	390	445	498
		7'	310	344	394	448	502
		7'2"	330	363	412	466	518
DOUBLES	4' + THRU 6'0"	6'8"	371	408	467	549	613
		7'	375	412	473	553	617
		7'2"	393	424	489	569	629
		8'	443	478	539	623	683
	6' + THRU 8'0"	6'8"	393	430	489	573	636
		7'	397	434	495	577	640
		7'2"	415	446	511	593	652
		8'	465	500	561	647	706

M-14 KD FRAMES

	WIDTH	HEIGHT	5-3/4 THRU 6	6-1/8 THRU 7-7/8	8 THRU 9-7/8	10 THRU 11-7/8	12 THRU 14
SINGLES	1'6" THRU 3'0"	6'8"	355	389	437	492	545
		7'	366	400	449	505	558
		7'2"	382	417	462	520	572
		8'	429	462	513	568	620
	3' + THRU 4'0"	6'8"	369	403	451	505	560
		7'	380	414	463	518	573
		7'2"	396	431	476	533	587
DOUBLES	4' + THRU 6'0"	6'8"	446	483	544	626	687
		7'	458	495	556	636	701
		7'2"	472	507	566	652	713
		8'	538	573	636	718	781
	6' + THRU 8'0"	6'8"	468	504	566	648	708
		7'	480	516	578	658	722
		7'2"	494	528	588	674	734
		8'	560	594	658	740	802

M-12 SMO FRAMES - FACTORY WELD ONLY

NOTE: Price with 12 ga. CCW

GENERAL INFORMATION

CURRIES M series frames are available double rabbet (equal or unequal). Prices reflect hardware preparations for 1 3/4" doors. Refer to CURRIES Architectural Technical Data Manual for standard details and limitations. Windstorm product frame label included.

2" face unequal rabbet profile frames are standard.

Jamb depth ranges are listed above each column. 1/8" increment jamb depths (all ranges 5-3/4" thru 14") are available at no extra charge.

EXTRAS

BUNDLING AND TAGGING FRAMES

Frame Order Code 3F, 3FH, 3FV, and SL
welded frames

Add \$6

M-12 FRAMES ONLY

Note: 5-3/4" jamb depth frames have 1/2" back bend. 7/16" N.A.

FRAME OPTIONS AVAILABLE ON PAGE 17



EXTRAS

Four (4") inch face heads (5 3/4" - 14") jamb depth

Available for 1 3/4" doors

Single including 4'0" Add \$57

Pairs over 4'0" Add \$80

GALVANEAL (A40 & A60) FRAME ADDS

A40 A60

Price per frame piece Add \$10 \$18

Price per 3-sided frame Add \$30 \$54

GALVANIZED (G-90)

Price per frame piece Add \$31

Price per 3-sided frame Add \$93

FIRE LABEL FRAMES (WITOUT E10 CLOSERS)

Warnock Hersey — Specify

Embossment; no hourly rating or 1 1/2 hour rating Standard

Metal label with hourly rating

Per hinge jamb Add \$29

Underwriters Laboratories

Single frame Add \$29

Double frame Add \$58

EXTRA

HARDWARE PREPARATIONS

CLOSER PREPARATIONS

Regular arm Add \$30

Parallel arm Add \$30

Half sleeve Add \$38

Full sleeve Add \$46

SURFACE BOLTS

Reinforce only Add \$30

HINGE PREPARATIONS

4 1/2" standard, heavyweight or Ultima Standard

1 1/2 pair up to and including 7'6" Standard

2 pair over 7'6" to 8'0" Standard

5" standard or heavyweight Add \$9

Full surface mounted continuous hinge reinforcement Add \$80

High frequency reinforcement strap support

Per hinge Add \$24

PANIC EXIT REINFORCING

Rim type Add \$30

Rim vertical rod surface mounted strike Add \$30

Vertical rod mortise strike in head Each Add \$65

STRIKES

4 7/8" Standard

2 3/4" ANSI lipped strike 1 3/4" door Standard

3 1/2" Standard

2 3/4" Standard

Removable Hardware Mullion Prep Add \$59

Electric Strike (E9) Add \$111

ANCHORS

SINGLE (ADD PER FRAME BY ANCHOR TYPE)				
SIZE	DESIGN PRESSURE	T	WPS	WMP WWS
Up to 3070	60/72/80/85/100	\$18	\$180	\$36
Up to 4070	57/85	\$18	\$180	\$36
Up to 4080		\$24	\$240	\$48
Up to 3080	60	\$24	\$240	\$48
Up to 4080	70	\$24	\$240	\$48
Up to 4080	50	\$24	\$240	\$48

DOUBLES (ADD PER FRAME BY ANCHOR TYPE)				
SIZE	DESIGN PRESSURE	T	WPS	WMP WWS
Up to 6070	60/75	\$24	\$240	\$48
Up to 8080 +	50/70	\$30	\$300	\$60
Up to 8080	62/70/75	\$30	\$300	\$60
Up to 6080	60	\$30	\$300	\$60
Up to 8080	70	\$30	\$300	\$60
+ Component Price				
Includes 2 anchors in head				

NOTE: Anchor type and quantity dictated by certification agency listing.

**Hurricane-Resistant Borrowed Light - Transom/Sidelight
w/Fire Rated Glass
Windstorm Prices**

DESIGN PRESSURE +/-70 WARNOCK ONLY

May, 2024

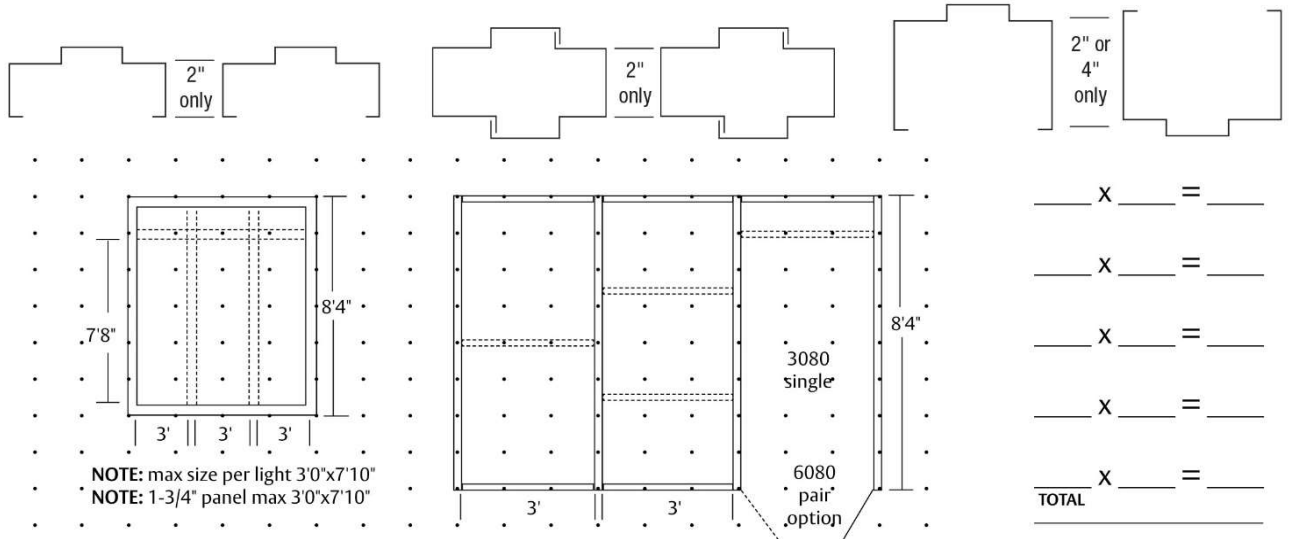

PRICE PER FOOT ESTIMATED

M-16	JAMB DEPTH RANGE	3 THRU 6	6-1/8 THRU 7-7/8	8 THRU 9-7/8	10 THRU 11-7/8	12 THRU 14
	STEEL TYPE	CRS	CRS	CRS	CRS	CRS
	Open Section 2" Face	\$14.06	\$16.24	\$19.00	\$22.18	\$25.53
	Open Section 4" Face	\$17.41	\$19.59	\$22.35	\$25.53	\$28.88
*	Mullion 2" Face	\$31.60	\$36.50	\$42.71	\$49.85	\$57.39
	Mullion 4" Face	\$38.87	\$44.89	\$52.54	\$61.32	\$70.59
	Glass Stop 5/8 x 5/8	\$6.00				
	Glass Stop 5/8 x 1	\$6.19				

GALVANNEAL (A40 & A60)		A40	A60
Open Sections	Add	\$1.76	\$3.18
Closed Sections	Add	\$3.52	\$6.36
GALVANIZED (G-90)			
Open Sections	Add		\$6.18
Closed Sections	Add		\$12.36

This per foot estimating formula includes foot clips and mullion stirrup anchors. All other anchor types are extra. Anchors must be ordered separately and will be invoiced accordingly. Factory weld charges do not include the cut charges.

Single door opening (4-1/2" hinge)	1 1/2 pair hinge preparations and strike	Add	\$72
Double Door Opening (4-1/2" hinge)	2 pair hinge preparations and strike	Add	\$90
Additional hinge or strike preparations (Per Preparation)	3 pair hinge preparations	Add	\$108
	4 pair hinge preparations	Add	\$144
Saw miter (SMO)		Add	\$18
Butt end notch (SBE) per notch		Add	\$17
Welded miter corner		Add	\$96
Welded butt end corner less than 3" face		Add	\$76
Welded butt end corner 3" face or larger		Add	\$108
Butt End - Face weld seam - mullion		Add	\$125
Windstorm Construction (Windstorm label included)			
		Single	Pair
		Add \$40	\$50

ANCHORS

T Anchors - Up to 5' jamb 8 anchors	Add	\$24	per frame
Over 5' jamb 16 anchors	Add	\$48	per frame
NOTE: Require WPS at head and sill 1 per lineal foot	Add	\$30	each
WPS Anchors - Require 1 each per every 16" of width and height	Add	\$30	each
* Mullions over 3 feet in length require 10 gauge channels	Add	\$304	per mullion

NOTE: Must be factory, Service Center, or authorized 2nd location welded.

WS-20

Hurricane-Resistant Transom or Sidelight Frame-Store Front
 Estimating CCW Per Foot M-16 Gauge



Windstorm Prices

May, 2024

DESIGN PRESSURE +/-60 UL ONLY

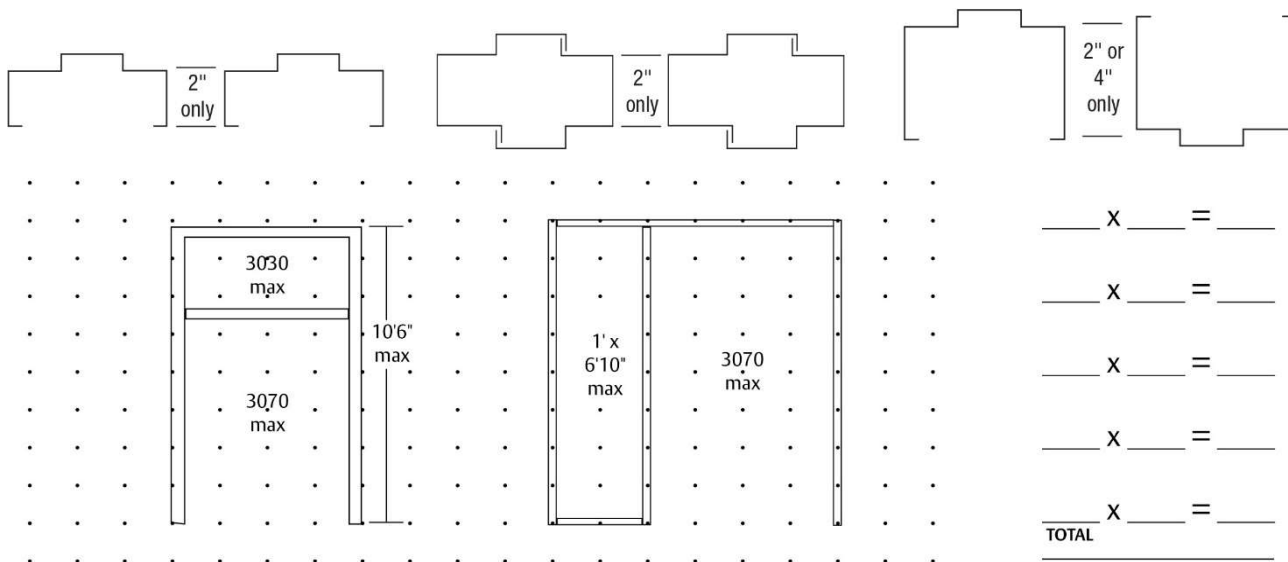

PRICE PER FOOT ESTIMATED

	JAMB DEPTH RANGE	3 THRU 6	6-1/8 THRU 7-7/8	8 THRU 9-7/8	10 THRU 11-7/8	12 THRU 14
	STEEL TYPE	CRS	CRS	CRS	CRS	CRS
	Open Section 2" Face	\$14.06	\$16.24	\$19.00	\$22.18	\$25.53
	Open Section 4" Face	\$17.41	\$19.59	\$22.35	\$25.53	\$28.88
*	Mullion 2" Face	\$31.60	\$36.50	\$42.71	\$49.85	\$57.39
	Mullion 4" Face	\$38.87	\$44.89	\$52.54	\$61.32	\$70.59
	Glass Stop 5/8 x 5/8	\$6.00				
	Glass Stop 5/8 x 1	\$6.19				

GALVANNEAL (A40 & A60)		A40	A60
Open Sections	Add	\$1.76	\$3.18
Closed Sections	Add	\$3.52	\$6.36
GALVANIZED (G-90)			
Open Sections	Add		\$6.18
Closed Sections	Add		\$12.36

This per foot estimating formula includes foot clips and mullion stirrup anchors. All other anchor types are extra. Anchors must be ordered separately and will be invoiced accordingly. Factory weld charges do not include the cut charges

Single door opening (4-1/2" hinge)	1 1/2 pair hinge preparations and strike	Add	\$72
Additional hinge or strike preparations (Per Preparation)	2 pair hinge preparations and strike	Add	\$90
Saw miter (SMO)		Add	\$18
Butt end notch (SBE) per notch		Add	\$17
Welded miter corner		Add	\$17
Welded butt end corner less than 3" face		Add	\$96
Welded butt end corner 3" face or larger		Add	\$76
Butt End - Face weld seam - mullion		Add	\$108
Windstorm Construction (Windstorm label included)		Add	\$125
		Single	Pair
		Add \$40	\$50

ANCHORS

T or Wire Anchors - Transom Frame	Add	\$30	per frame
Sidelight Frame	Add	\$24	per frame
WPS Transom (less bolts)	Add	\$200	(qty of 10)
Sidelight	Add	\$216	(qty of 8)

* Mullions over 3 feet in length require 10 gauge channels

Add per mullion \$304

NOTE: Must be factory, Service Center, or authorized 2nd location welded.

Hurricane-Resistant Borrowed Light - Store Front
Estimating CCW Per Foot M-14 Gauge
Windstorm Prices

May, 2024

DESIGN PRESSURE +/-60 UL ONLY

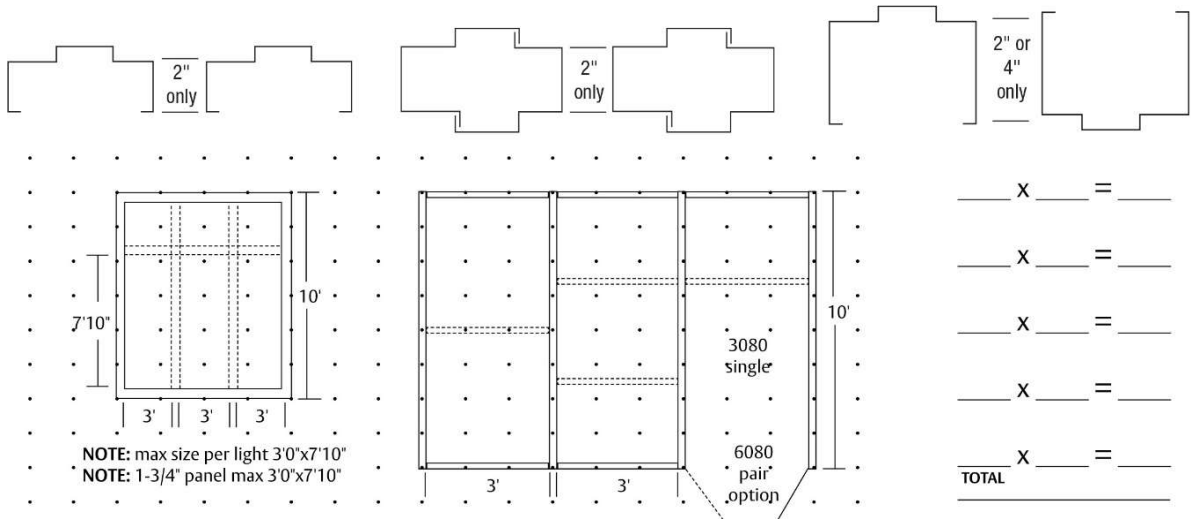

PRICE PER FOOT ESTIMATED

	JAMB DEPTH RANGE	3 THRU 6	6-1/8 THRU 7-7/8	8 THRU 9-7/8	10 THRU 11-7/8	12 THRU 14
	STEEL TYPE	CRS	CRS	CRS	CRS	CRS
	Open Section 2" Face	\$18.12	\$20.12	\$23.00	\$26.29	\$29.41
	Open Section 4" Face	\$21.47	\$23.47	\$26.35	\$29.65	\$32.76
*	Mullion 2" Face	\$38.28	\$42.51	\$48.60	\$55.56	\$62.15
	Mullion 4" Face	\$45.94	\$51.01	\$58.32	\$66.67	\$74.58
	Glass Stop 5/8 x 5/8	\$6.00				
	Glass Stop 5/8 x 1	\$6.19				

GALVANNEAL (A40 & A60)		A40	A60
Open Section	Add	\$1.76	\$3.18
Closed Sectic	Add	\$3.52	\$6.36
GALVANIZED (G-90)			
Open Section	Add		\$6.18
Closed Sectic	Add		\$12.36

This per foot estimating formula includes foot clips and mullion stirrup anchors. All other anchor types are extra. Anchors must be ordered separately and will be invoiced accordingly. Factory weld charges do not include the cut charges

Single door opening (4-1/2" hinge)	1 1/2 pair hinge preparations and strike	Add	\$72
Double Door Opening (4-1/2" hinge)	2 pair hinge preparations and strike	Add	\$90
Additional hinge or strike preparations (Per Preparation)	3 pair hinge preparations	Add	\$108
Saw miter (SMO)	4 pair hinge preparations	Add	\$144
Butt end notch (SBE) per notch		Add	\$18
Welded miter corner		Add	\$17
Welded butt end corner less than 3" face		Add	\$17
Welded butt end corner 3" face or larger		Add	\$96
Butt End - Face weld seam - mullion		Add	\$76
Windstorm Construction (Windstorm label included)		Add	\$108
			Add \$125
			Single
			Pair
		Add	\$40 \$50

ANCHORS

T Anchors - Up to 5' jamb 8 anchors	Add	\$24	per frame
Over 5' jamb 16 anchors	Add	\$48	per frame
NOTE: Require WPS at head and sill 1 per lineal foot	Add	\$30	each
WPS Anchors - Require 1 each per every 16" of width and height	Add	\$30	each
* Mullions over 3 feet in length require 10 gauge channels	Add	\$304	per mullion

NOTE: Must be factory, Service Center, or authorized 2nd location welded.

Hurricane-Resistant Transom or Sidelight Frame-Store Front
 Estimating CCW Per Foot M-14 Gauge

Windstorm Prices

May, 2024

DESIGN PRESSURE +/-60 UL ONLY

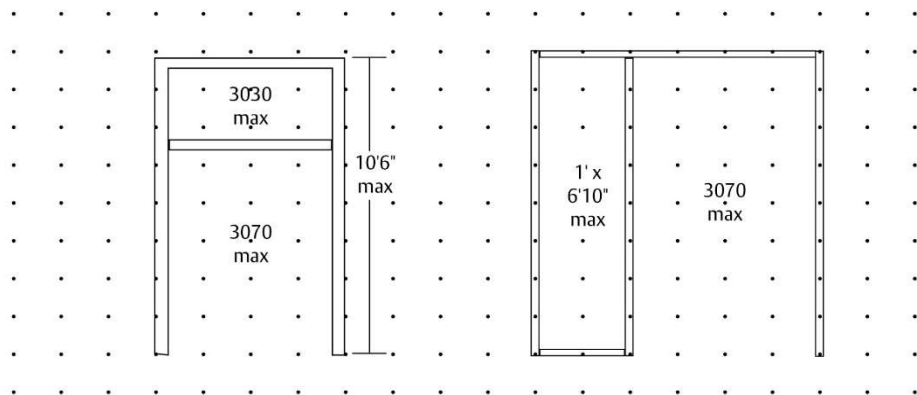
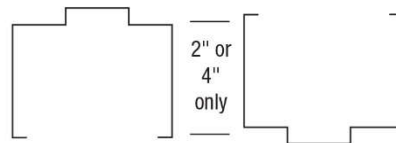
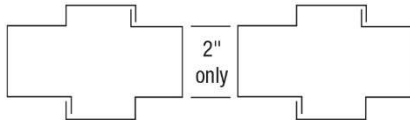
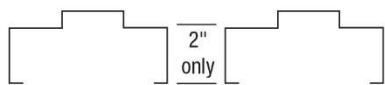

_____	X	_____	=	_____
_____	X	_____	=	_____
_____	X	_____	=	_____
_____	X	_____	=	_____
_____	X	_____	=	_____
TOTAL	X	_____	=	_____

PRICE PER FOOT ESTIMATED

	JAMB DEPTH RANGE	3 THRU	6-1/8	8 THRU	10	12
		6	THRU 7-7/8	9-7/8	THRU 11-7/8	THRU 14
	STEEL TYPE	CRS	CRS	CRS	CRS	CRS
	Open Section 2" Face	\$18.12	\$20.12	\$23.00	\$26.29	\$29.41
	Open Section 4" Face	\$21.47	\$23.47	\$26.35	\$29.65	\$32.76
*	Mullion 2" Face	\$38.28	\$42.51	\$48.60	\$55.56	\$62.15
	Mullion 4" Face	\$45.94	\$51.01	\$58.32	\$66.67	\$74.58
	Glass Stop 5/8 x 5/8	\$6.00				
	Glass Stop 5/8 x 1	\$6.19				

GALVANNEAL (A40 & A60)		A40	A60
Open Sections	Add	\$1.76	\$3.18
Closed Sections	Add	\$3.52	\$6.36
GALVANIZED (G-90)			
Open Sections	Add		\$6.18
Closed Sections	Add		\$12.36

This per foot estimating formula includes foot clips and mullion stirrup anchors. All other anchor types are extra. Anchors must be ordered separately and will be invoiced accordingly. Factory weld charges do not include the cut charges.

Single door opening (4-1/2" hinge)	1 1/2 pair hinge preparations and strike	Add	\$72
Additional hinge or strike preparations (Per Preparation)	2 pair hinge preparations and strike	Add	\$90
Saw miter (SMO)		Add	\$108
Butt end notch (SBE) per notch		Add	\$144
Welded miter corner		Add	\$18
Welded butt end corner less than 3" face		Add	\$17
Welded butt end corner 3" face or larger		Add	\$17
Butt End - Face weld seam - mullion		Add	\$96
Windstorm Construction (Windstorm label included)		Add	\$76
			Single
			Pair
		Add	\$40 \$50

ANCHORS

T or Wire Anchors - Transom Frame	Add	\$30	per frame
Sidelight Frame	Add	\$24	per frame
WPS Transom (less bolts)	Add	\$200	(qty of 10)
Sidelight	Add	\$216	(qty of 8)
	Add per mullion	\$304	

* Mullions over 3 feet in length require 10 gauge channels

NOTE: Must be factory, Service Center, or authorized 2nd location welded.

707S CURRISTain Six Panel Door 18 ga. Hurricane-Resistant Door Prices

May, 2024



WIDTH	HEIGHT	E6 18 GALV.	E6HGS* 18 GALV.
28 210 30	68	\$2,883	\$3,403
28 210 30	70	\$2,994	\$3,514

LISTED FIRE LABEL DOORS

Label door restrictions per gauge and size can be determined in the General Information Section. Prices are without closers (CL).

		Less CL
Underwriters Laboratories	ABCG	Add \$65
Warnock Hersey	ABCG	Add \$17
20 minute U.L. or W.H.I.		Add \$17
Label construction		Add \$24
Verify label door limitations		

HURRICANE CODE LABEL

Warnock Hersey H Component	Add \$15
Underwriters Laboratory X Assembly	Add \$15
Underwriters Laboratory H Component	Add \$15

NON STANDARD SIZE DOORS - CONTACT FACTORY

OVERSIZED DOOR OPTIONS - NOT AVAILABLE

CAPS - Top or bottom

Steel installed flush (with screws per cap)	Add \$26
---	----------

CLOSER

Surface mounted reinforcement only	Add \$36
------------------------------------	----------

HINGE PREPARATIONS

4 1/2" standard, heavyweight, or Ultima	Standard
Continuous hinge preparation (mounting holes field drilled)	
Concealed mounting + (e.g. McKinney - 11, 24)	
12 gauge hinge rail standard (Specify)	No Add

+ non standard door size charge applied to less than 13 special size doors per order; 13 or more no add.

CURRISTAIN COLOR OPTIONS

Wheat, Natural, Cashew, Cocoa, Cabernet, Java

STANDARD DESCRIPTION

Galvanneal (A40) steel 18 gauge steel.
Polystyrene core
"S" exposed edge seam
1-3/4" thick doors only

EDGE BEVELS AVAILABLE

"A" standard (1/8" in 2" lock edge - square hinge edge)	No Add
"G" Specify (1/8" in 2" bevel both edges)	Add \$18

LOCK PREPARATIONS

Cylindrical lock 161	G2	Standard
Cylindrical lock - Lever trim holes (Universal lever trim prep.)	G2B	Standard
**Deadlock - tubular 181	G16	Standard
Interconnected lock	G25	Add \$58
Mortise lock 1-3/4" door escutcheon trim	G3	Standard
Hotel and master ring cylinder functions	**G3A	Add \$77
Mortise lock edge only preparation	G3AEO	Standard
*Mortise panic exit	G12	Add \$87
*Rim panic reinforce only	G11	Add \$46
*Rim panic reinforce with function holes	G11	Add \$46
*Rim vertical rod reinforce only	G11A	Add \$87
*Rim vertical rod with function holes	G11A	Add \$87

** Approved deadlock must be used with qualified cylindrical lock on +/-70 single opening

* Not available 70 PSF doors

LOUVERS - preparation or installation is not available from the factory

UNDERCUTS

1 3/4" doors - 3/4" min. standard	No Add
All other undercuts per door	Add \$24

NOTE: Charges waived when quantities exceed 24 doors with any combination of non-standard undercuts.

CONSTRUCTION ADDS

See preface (page WS-3)

See Hurricane-Resistant Guide in partner area of www.curries.com for available hardware.

WS-24
M-14 KD 150 psf Frames
Hurricane-Resistant Frame Prices

May, 2024



	WIDTH	HEIGHT	4 THRU 6	6-1/8 THRU 7-7/8	8 THRU 9-7/8	10 THRU 11-7/8	12 THRU 14
SINGLES	1'6"	7'	\$973	\$1,007	\$1,056	\$1,112	\$1,165
	THRU 3'0"	7'2"	\$989	\$1,024	\$1,069	\$1,127	\$1,179
	3' +	8'	\$1,036	\$1,069	\$1,120	\$1,175	\$1,227
	THRU 4'0"	7'	\$987	\$1,021	\$1,070	\$1,125	\$1,180
		7'2"	\$1,003	\$1,038	\$1,083	\$1,140	\$1,194
		8'	\$1,050	\$1,083	\$1,134	\$1,188	\$1,242
DOUBLES	4' +	7'	\$1,055	\$1,092	\$1,153	\$1,233	\$1,298
	THRU 6'0"	7'2"	\$1,069	\$1,104	\$1,163	\$1,249	\$1,310
		8'	\$1,135	\$1,170	\$1,233	\$1,315	\$1,378
	6' +	7'	\$1,077	\$1,113	\$1,175	\$1,255	\$1,319
	THRU 8'0"	7'2"	\$1,091	\$1,125	\$1,185	\$1,271	\$1,331
		8'	\$1,157	\$1,191	\$1,255	\$1,337	\$1,399

GENERAL INFORMATION

CURRIES M series frames are available double rabbet (equal or unequal), rabbet. Prices reflect hardware preparations for 1-3/4" doors. Refer to CURRIES Architectural Technical Data Manual for standard details and limitations. Storm- Pro product frame label included.

Windstorm label included.

2" face unequal rabbet profile frames are standard. CRS is standard.

12 ga. lintel channel reinforcement included in price.

EXTRAS

BUNDLING AND TAGGING FRAMES

- Frame Order Code 3F welded frames Add \$6
- Four (4") inch face heads (5-3/4" - 14") jamb depth Available for 1-3/4" doors Single including 4'0" Add \$57
- Pairs over 4'0" Add \$80

FIRE LABEL FRAMES (WITHOUT E10 CLOSER)

- Underwriters Laboratories Single frame Add \$29
- Double frame Add \$57

ANCHORS

- T-Anchors Standard
- WPS Anchors
- 7'0" Add \$240
- 8'0" Add \$300

HARDWARE PREPARATIONS

- Multi-point Lock Preps Standard

SURFACE BOLTS

- Reinforce only Standard

HINGE PREPARATIONS

- 4 1/2" standard, heavyweight Standard
- 1 1/2 pair up to and including 7'6" Standard
- 2 pair over 7'6" to 8'0" Standard
- Continuous Hinges Add \$80

CLOSER PREPARATION

- Regular arm E10 Add \$30

GALVANNEAL (A40 or A60) FRAME ADDS

- Price per 3-Sided frame Add A40 A60
\$30 \$54

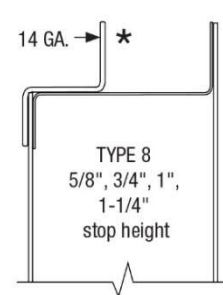
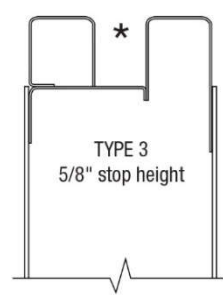
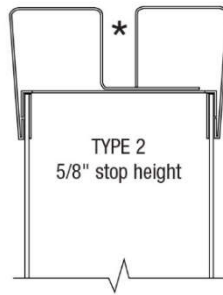
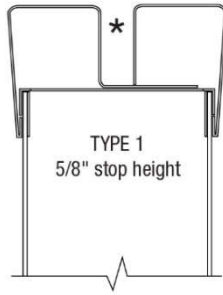

STANDARD KIT AND 14 GA. SURROUND CHANNEL

* POCKET SIZE 3/8" ONLY FOR 1-3/4" DOORS		* POCKET SIZE 5/8", 7/8" AND 1-1/8" FOR 1-3/4" DOORS ONLY		* POCKET SIZE 3/8", 1/2" AND 5/8" FOR 1-3/4", 2" OR 2-1/4" DOORS		* POCKET SIZE 3/8" THRU 1-5/8" FOR 1-3/4" OR 2" DOORS	
FV	\$396	FV	\$515	FV	\$311	FV	\$512
FNV	\$423	FNV	\$542	FNV	\$354	FNV	\$594
HG	\$466	HG	\$585	HG	\$419	HG	\$726
FG	\$588	FG	\$707	FG	\$683	FG	\$1,151
FG2	\$764	FG2	\$883	FG2	\$838	FG2	\$1,573
FG3	\$950	FG3	\$1,069	FG3	\$1,257	FG3	\$2,360
FG4	\$1,136	FG4	\$1,255	FG4	\$1,676	FG4	\$3,146
#6 SCREW		#6 SCREW		#6 SCREW		#6 x 3/4 SCREW	

* Price includes required surround channel

Windstorm WLV60 Louver Pricing Chart
Pricing includes Galvanizing, Cutout and Surround Channel.
Louvers must be factory installed or by a UL or Warnock Windstorm second location.

	WIDTH						
	12	14	16	18	20	22	24
12	\$605	\$685	\$697	\$645	\$736	\$745	\$699
14	\$685	\$697	\$704	\$736	\$745	\$776	\$792
16	\$697	\$704	\$736	\$745	\$776	\$792	\$802
18	\$704	\$736	\$745	\$776	\$792	\$802	\$691
20	\$736	\$745	\$776	\$792	\$802	\$837	\$866
22	\$745	\$776	\$792	\$802	\$837	\$871	\$913
24	\$776	\$792	\$802	\$837	\$871	\$913	\$924
36	\$961	\$990	\$1,056	\$1,088	\$1,143	\$1,176	\$1,259
42	\$1,250	\$1,297	\$1,337	\$1,402	\$1,464	\$1,524	\$1,590
48	\$1,402	\$1,464	\$1,524	\$1,590	\$1,631	\$1,693	\$1,758
54	\$1,590	\$1,631	\$1,693	\$1,758	\$1,804	\$1,848	\$1,901
60	\$1,758	\$1,804	\$1,848	\$1,901	\$1,928	\$1,980	\$2,020
64	\$1,904	\$1,901	\$1,928	\$1,980	\$2,020	\$2,071	\$2,110

- * Custom size, use next size up on chart and add 10%
- * Pricing does not include freight from supplier.
- * Zinc plated-call for quote
- * Louver with bug screen - per perimeter add:
0"-96" \$81
97"-120" \$156
121"-228" \$304

WS-26

Notes

Tornado-Resistant Prices

 CURRIES®

ASSA ABLOY

StormPro™ 361 Assembly with Multi-Point Lock
Tornado-Resistant Prices

May, 2024

FOR USE WITH CORBIN RUSSWIN FE6600 OR SARGENT FM7300

Storm Pro 361 assemblies are door and frame assemblies which have been tested and comply with the FEMA P-361 (2021), FEMA P-320 (2021) and ICC 500 (2014/2020) guideline to provide inhabitants protection from tornados, hurricanes, and straight line winds. Up to 3 hr. UL fire label available. Size and hardware restrictions apply to products published below at this time. All hardware "by others".

Corbin Russwin FE6600 and SARGENT FM7300 concealed vertical rods, top and bottom bolts, and mortise lock body cassette must be factory installed in a CURRIES StormPro door. All other hardware components are shipped directly from SARGENT or Corbin Russwin and must be installed by a factory trained installer.

IMPORTANT: Do not remove any hardware blocking or filler plates in the door or the frame until the mortise lock is ready to be installed.

14 GA. DOORS

WIDTH	HEIGHT	14 GA
28, 210, 30	68 - 70	\$5,943
34, 36	68 - 70	\$6,200
38, 310, 40	68 - 70	\$6,314
28, 210, 30	72	\$6,158
34, 36	72	\$6,321
38, 310, 40	72	\$6,440
28, 210, 30	80	\$6,386
34, 36	80	\$6,556
38, 310, 40	80	\$6,665

Seamless T edge	Standard	
Flush top cap	Standard	
3/8" standard undercut	Standard	
Handed "A" bevel doors		
UL fire label A, B, C, G (excludes closer	Add	\$65
20 minute label	Add	\$17
Astragal (if required to meet BAA)	Add	\$94
Closer reinforcement	Add	\$36
StormPro Hurricane & Tornado Resistant Impact Protective Systems - FLUSH ONLY		
FBC approval FL# 40296		
Design pressure is +/- 227 psf		
Combined Hurricane and Tornado Label	Add	\$154

A40 or A60 Galvaneal		A40	A60
a. 68 HEIGHT	Add	\$48	\$97
b. 70 HEIGHT	Add	\$48	\$103
c. 72 HEIGHT	Add	\$48	\$111
d. 80 HEIGHT	Add	\$48	\$118
G90 Galvanized			
a. 68 HEIGHT	Add	\$354	
b. 70 HEIGHT	Add	\$361	
c. 72 HEIGHT	Add	\$367	
d. 80 HEIGHT	Add	\$373	
Glass Lites - Factory Installed (prices include kit) & Replaceable Module - Field Installed			
Non-fire rated 10"x10"	Add	\$4,544	
Fire Rated 10"x10"	Add	\$8,947	
Non-fire rated 4"x25"	Add	\$5,512	
Fire Rated 4"x25"	Add	\$10,473	

OVERSIZED DOOR OPTIONS – Not available

M-14 KD FRAMES

	WIDTH	HEIGHT	4 THRU 6	6-1/8 THRU 7-7/8	8 THRU 9-7/8	10 THRU 11-7/8	12 THRU 14
SINGLE	28 - 30	70	\$1,074	\$1,103	\$1,146	\$1,228	\$1,285
		72	\$1,100	\$1,119	\$1,164	\$1,247	\$1,302
		80	\$1,155	\$1,179	\$1,215	\$1,277	\$1,329
	31 - 40	70	\$1,085	\$1,108	\$1,153	\$1,234	\$1,293
		72	\$1,111	\$1,124	\$1,171	\$1,253	\$1,310
		80	\$1,166	\$1,184	\$1,222	\$1,283	\$1,337
DOUBLE	60	70	\$1,150	\$1,171	\$1,217	\$1,285	\$1,340
		72	\$1,170	\$1,187	\$1,237	\$1,305	\$1,360
		80	\$1,244	\$1,265	\$1,305	\$1,349	\$1,404
	61 - 80	70	\$1,166	\$1,186	\$1,240	\$1,306	\$1,359
		72	\$1,186	\$1,202	\$1,260	\$1,326	\$1,379
		80	\$1,260	\$1,280	\$1,328	\$1,370	\$1,423

GENERAL INFORMATION

CURRIES M series frames are available double rabbet (equal or unequal), rabbet. Prices include hardware preparations for 1-3/4" doors. Refer to CURRIES Architectural Technical Data Manual for standard details and limitations. StormPro product frame label included. Communicating frame available.

2" face unequal rabbet profile frames are standard.
12 ga. lintel channel reinforcement included in price.

M-14 KD CRS FRAMES

2" face only, 4" head available. 8080 max.		
Tagging and bundling	Add	\$6
10 T anchors - included with WPS in head.		
4" face head single - 4-5/8" min. depth	Add	\$57
4" face head double - 4-5/8" min. Depth	Add	\$80
12 WEWA Anchors	Add	\$382
Head anchors included in base price	A40	A40
A40 or A60 Galvaneal	Add	\$30
G90 Galvanized	Add	\$93
Optional 4-sided frame	Add	\$355

Note: 4-sided frame must be welded.

See welded assemblies for corner welding prices.

UNDERWRITERS LABORATORIES

Single frame	Add	\$29
Double frame	Add	\$58

WELDED ASSEMBLIES

Seam Weld	3-Sided Frame	Add	\$86
Full Weld	3-Sided Frame	Add	\$154
Seam Weld	4-Sided Frame	Add	\$172
Full Weld	4-Sided Frame	Add	\$308

NOTE: This product is manufactured offsite and ships separately. Call to verify lead-times and ship schedule.

StormPro™ 361 Assembly with Multi-Point Lock

Tornado-Resistant Prices

May, 2024



FOR USE WITH CORBIN RUSSWIN FE6600 OR SARGENT FM7300

Storm Pro 361 assemblies are door and frame assemblies which have been tested and comply with the FEMA P-361 (2021), FEMA P-320 (2021) and ICC 500 (2014/2020) guideline to provide inhabitants protection from tornados, hurricanes, and straight line winds. Up to 3 hr. UL fire label available. Size and hardware restrictions apply to products published below at this time. All hardware "by others".

Corbin Russwin FE6600 and SARGENT FM7300 concealed vertical rods, top and bottom bolts, and mortise lock body cassette must be factory installed in a CURRIES StormPro door. All other hardware components are shipped directly from SARGENT or Corbin Russwin and must be installed by a factory trained installer.

IMPORTANT: Do not remove any hardware blocking or filler plates in the door or the frame until the mortise lock is ready to be installed.

12 GA. DOORS

WIDTH	HEIGHT	12 GA
28, 210, 30	68 - 70	\$7,381
34, 36	68 - 70	\$7,500
38, 310, 40	68 - 70	\$7,541
28, 210, 30	72	\$7,661
34, 36	72	\$7,689
38, 310, 40	72	\$7,734
28, 210, 30	80	\$7,787
34, 36	80	\$7,863
38, 310, 40	80	\$7,921

Seamless T edge	Standard	
Flush top cap	Standard	
Closer reinforcement	Add	\$36
Handed "A" bevel doors		
UL fire label A, B, C, G (excludes closer)	Add	\$65
20 minute label	Add	\$17
Astragal (if required to meet BAA)	Add	\$94
3/8" standard undercut	No Add	
StormPro Hurricane & Tornado Resistant Impact Protective Systems - FLUSH ONLY		
FBC approval FL# 40296		
Design pressure is +/- 227 psf		
Combined Hurricane and Tornado Label	Add	\$154

A40 or A60 Galvaneal		A40	A60
a. 68 HEIGHT	Add	\$48	\$97
b. 70 HEIGHT	Add	\$48	\$103
c. 72 HEIGHT	Add	\$48	\$111
d. 80 HEIGHT	Add	\$48	\$118
G90 Galvanized			
a. 68 HEIGHT	Add	\$354	
b. 70 HEIGHT	Add	\$361	
c. 72 HEIGHT	Add	\$367	
d. 80 HEIGHT	Add	\$373	
Glass Lites - Factory Installed (prices include kit) & Replaceable Module - Field Installed			
Non-fire rated 10"x10"	Add	\$4,544	
Fire rated 10"x10"	Add	\$8,947	
Non-fire rated 4"x25"	Add	\$5,512	
Fire Rated 4"x25"	Add	\$10,473	

OVERSIZED DOOR OPTIONS – Not available

M-12 KD FRAMES

	WIDTH	HEIGHT	4 THRU 6	6-1/8 THRU 7-7/8	8 THRU 9-7/8	10 THRU 11-7/8	12 THRU 14
SINGLE	28 - 30	70	\$1,429	\$1,459	\$1,503	\$1,584	\$1,646
		72	\$1,464	\$1,485	\$1,528	\$1,614	\$1,671
		80	\$1,535	\$1,557	\$1,594	\$1,658	\$1,712
	31 - 40	70	\$1,447	\$1,471	\$1,517	\$1,596	\$1,658
		72	\$1,482	\$1,497	\$1,542	\$1,626	\$1,683
		80	\$1,553	\$1,569	\$1,608	\$1,670	\$1,724
DOUBLE	60	70	\$1,535	\$1,558	\$1,605	\$1,670	\$1,730
		72	\$1,561	\$1,578	\$1,625	\$1,690	\$1,748
		80	\$1,651	\$1,674	\$1,711	\$1,754	\$1,812
	61 - 80	70	\$1,563	\$1,586	\$1,641	\$1,705	\$1,762
		72	\$1,589	\$1,606	\$1,661	\$1,725	\$1,780
		80	\$1,679	\$1,702	\$1,747	\$1,789	\$1,844

GENERAL INFORMATION

CURRIES M series frames are available double rabbet (equal or unequal), rabbet. Prices include hardware preparations for 1-3/4" doors. Refer to CURRIES Architectural Technical Data Manual for standard details and limitations. StormPro product frame label included. Communicating frame available.

2" face unequal rabbet profile frames are standard.
12 ga. lintel channel reinforcement included in price.

M-14 KD CRS FRAMES

2" face only, 4" head available. 8080 max.

Tagging and bundling	Add	\$6
10 T anchors - included with WPS in head.		
4" face head single - 4-5/8" min. depth	Add	\$57
4" face head double - 4-5/8" min. Depth	Add	\$80
12 WEWA Anchors	Add	\$382
Head anchors included in base price	A40	A40

UNDERWRITERS LABORATORIES

Single frame	Add	\$29
Double frame	Add	\$58

WELDED ASSEMBLIES

Seam Weld	3-Sided Frame	Add	\$86
Full Weld	3-Sided Frame	Add	\$154
Seam Weld	4-Sided Frame	Add	\$172
Full Weld	4-Sided Frame	Add	\$308

A40 or A60 Galvaneal	Add	\$30	\$54
G90 Galvanized	Add	\$93	
Optional 4-sided frame	Add	\$355	
Note: 4-sided frame must be welded.			

NOTE: This product is manufactured offsite and ships separately. Call to verify lead-times and ship See welded assemblies for corner welding prices.

Storm-Pro™ 320 Assembly with Cylindrical Lock and Deadbolts Tornado-Resistant Prices

May, 2024

FOR USE WITH SARGENT 10 LINE SERIES AND MEDECO MAXUM DEADBOLTS

Storm Pro 320 assemblies are door and frame assemblies which have been tested and comply with the FEMA P-320 (2021) and ICC 500 (2014/2020) for the design and construction of storm shelters) for safe rooms to provide inhabitants protection from tornados, hurricanes, and straight line winds. Size and hardware restrictions apply to products published below at this time.

14 GA. DOORS

WIDTH	HEIGHT	14 GAUGE
28-30	68	\$2,161
28-30	70	\$2,186

OVERSIZED DOOR OPTIONS – Not available

A40 or A60 Galvaneal		A40	A40
a. 68 HEIGHT	Add	\$48	\$97
b. 70 HEIGHT	Add	\$48	\$103
G90 Galvanized			
a. 68 HEIGHT	Add	\$354	
b. 70 HEIGHT	Add	\$361	

3070 max.		
Seamless T edge		
Flush top and bottom caps		
Closer reinforce		\$36
Cylindrical lock and three (3) deadlock preparations		
320 certified label (T2 Code)		
Handed "A" bevel doors		
5/8" Standard undercut		
3/8" and 3/4" undercut available		
All other undercuts per door		
Factory installed 10" x 10" light (price includes FV kit)		\$4,544

HARDWARE – Hardware package required for FEMA 320 door and frame assembly. Shipped loose - SP320HDWE \$2,257

- (3) McKinney SP3786 26D (4-1/2" x 4-1/2" x .180")
- (1) Sargent 10 line grade 1 passage set 28-10U15XLLX26DLHR
- (3) Medeco Maxum commercial high security deadbolts 11C602T-26-DL-T-N A, KA3

LISTED FIRE LABELS – Not Available

M-16 KD FRAMES - STORMPRO 320

WIDTH	HEIGHT	4 THRU 6	6-1/8 THRU 7-7/8	8 THRU 9-7/8	10 THRU 11-7/8	12 THRU 14
28-30	68	\$996	\$1,019	\$1,063	\$1,168	\$1,228
	70	\$1,002	\$1,029	\$1,078	\$1,181	\$1,241

GENERAL INFORMATION

CURRIES M series frames are available double or single rabbit. Prices include hardware preparations for 1-3/4" doors. Refer to CURRIES Architectural Technical Data Manual for standard details and limitations. StormPro product frame label included.

M-16 KD CRS FRAMES

2" face only, 4" head available.		
Tagging and bundling	Add	\$6
12 ga. lintel channel reinforcement included in price.		
10 T anchors - included with WPS in head.		
12 WEWA Anchors	Add	\$382
4" face head single - 4-5/8" min. depth	Add	\$57
		A40 A60
A40 or A60 Galvaneal	Add	\$30 \$54
G90 Galvanized	Add	\$93

WELDED ASSEMBLIES (3 SIDED FRAME)

Seam Weld Die Miter (KD)	SW	Add	\$86
Full Weld Die Miter (KD)	FW	Add	\$154

LISTED FIRE LABELS – Not Available

14 gauge 3-sided frame	Add	\$65
------------------------	-----	------

NOTE: This product is manufactured offsite and ships separately. Call to verify lead-times and ship schedule.

WS-30

StormPro™ 361 Assembly with Exit Device

Tornado-Resistant Prices

May, 2024



FOR USE WITH SARGENT FM 8700/FM PE8700 OR CORBIN RUSSWIN FE5400S/PED5400 FE X FE707A/FE708A MULLION

Storm Pro 361 assemblies are door and frame assemblies which have been tested and comply with the FEMA P-361 (2021), FEMA P-320 (2021) and ICC 500 (2014/2020) guidelines to provide inhabitants protection from tornados, hurricanes, and straight line winds. Up to 3 hr. UL fire label available. Size and hardware restrictions apply to products published below at this time. All hardware "by others".

14 GA. DOOR

WIDTH	HEIGHT	14 GAUGE
30	68 - 70	\$5,177
34, 36	68 - 70	\$5,426
38, 310, 40	68 - 70	\$5,540
30	72	\$5,371
34, 36	72	\$5,534
38, 310, 40	72	\$5,655
30	80	\$5,602
34, 36	80	\$5,771
38, 310, 40	80	\$5,880

Seamless T edge	Standard	A40 or A60 Galvaneal	A40	A60
Flush top cap	Standard	a. 68 HEIGHT	Add \$48	\$97
Closer reinforcement	Add \$36	b. 70 HEIGHT	Add \$48	\$103
Handed "A" bevel doors		c. 72 HEIGHT	Add \$48	\$111
UL fire label A, B, C, G (excludes closer)	Add \$65	d. 80 HEIGHT	Add \$48	\$118
20 minute label	Add \$17	G90 Galvanized		
5/8" standard undercut	No Add	a. 68 HEIGHT	Add \$354	
StormPro Hurricane & Tornado Resistant Impact Protective Systems - FLUSH ONLY		b. 70 HEIGHT	Add \$361	
FBC approval FL# 40296		c. 72 HEIGHT	Add \$367	
Design pressure is +/- 227 psf		d. 80 HEIGHT	Add \$373	
Combined Hurricane and Tornado Label	Add \$154	Glass Lites - Factory Installed (prices include kit) & Replaceable Module - Field Installed		
		Non-fire rated 10"x10"	Add \$4,544	
		Fire rated 10"x10"	Add \$8,947	
		Non-fire rated 4"x25"	Add \$5,512	
		Fire Rated 4"x25"	Add \$10,473	

OVERSIZED DOOR OPTIONS – Not available

M-14 KD FRAMES

	WIDTH	HEIGHT	4 THRU 6	6-1/8 THRU 7-7/8	8 THRU 9-7/8	10 THRU 11-7/8	12 THRU 14
SINGLE	30	68 - 70	\$1,074	\$1,103	\$1,146	\$1,228	\$1,285
		72	\$1,100	\$1,119	\$1,164	\$1,247	\$1,302
		80	\$1,155	\$1,179	\$1,215	\$1,277	\$1,329
	31 - 40	68 - 70	\$1,085	\$1,108	\$1,153	\$1,234	\$1,293
		72	\$1,111	\$1,124	\$1,171	\$1,253	\$1,310
		80	\$1,166	\$1,184	\$1,222	\$1,283	\$1,337
DOUBLE	60	68 - 70	\$1,150	\$1,171	\$1,217	\$1,285	\$1,340
		72	\$1,170	\$1,187	\$1,237	\$1,305	\$1,360
		80	\$1,244	\$1,265	\$1,305	\$1,349	\$1,404
	61 - 80	68 - 70	\$1,166	\$1,186	\$1,240	\$1,306	\$1,359
		72	\$1,186	\$1,202	\$1,260	\$1,326	\$1,379
		80	\$1,260	\$1,280	\$1,328	\$1,370	\$1,423

GENERAL INFORMATION

CURRIES M series frames are available double or single rabbet. Prices reflect hardware preparations for 1-3/4" doors. Refer to CURRIES Architectural Technical Data Manual for standard details and limitations. StormPro product frame label included.

M-14 KD CRS FRAMES

2" face unequal rabbet profile frames are standard.

2" face only, 4" head available. 8080 max.

Tagging and bundling Add \$6

12 ga. lintel channel reinforcement included in price.

4" face head single - 4-5/8" min. depth Add \$57

4" face head double - 4-5/8" min. depth Add \$80

10 T anchors - included with WPS in head.

12 WEWA Anchors Add \$382

Head anchors included in base price

	A40	A60
A40 or A60 Galvaneal	Add \$30	\$54
G90 Galvanized	Add	\$93

UNDERWRITERS LABORATORIES

Single frame Add \$29

Double frame Add \$58

WELDED ASSEMBLIES (3 SIDED FRAME)

Seam Weld Die Miter (KD) Add \$86

Full Weld Die Miter (KD) Add \$154

StormPro™ 361 Assembly with Exit Device
Tornado-Resistant Prices

May, 2024

FOR USE WITH SARGENT FM 8700/FM PE8700 OR CORBIN RUSSWIN FE5400S/PED5400 FE X FE707A/FE708A MULLION

Storm Pro 361 assemblies are door and frame assemblies which have been tested and comply with the FEMA P-361 (2021), FEMA P-320 (2021) and ICC 500 (2014/2020) guidelines to provide inhabitants protection from tornados, hurricanes, and straight line winds. Up to 3 hr. UL fire label available. Size and hardware restrictions apply to products published below at this time. All hardware "by others".

12 GA. DOOR

WIDTH	HEIGHT	12 GAUGE
30	68 - 70	\$6,430
34, 36	68 - 70	\$6,565
38, 310, 40	68 - 70	\$6,616
30	72	\$6,682
34, 36	72	\$6,732
38, 310, 40	72	\$6,792
30	80	\$6,831
34, 36	80	\$6,922
38, 310, 40	80	\$6,988

OVERSIZED DOOR OPTIONS – Not available

Seamless T edge	Standard	A40 or A60 Galvaneal	A40	A60
Flush top cap	Standard	a. 68 HEIGHT	Add \$48	\$97
Closer reinforcement	Add \$36	b. 70 HEIGHT	Add \$48	\$103
Handed "A" bevel doors		c. 72 HEIGHT	Add \$48	\$111
UL fire label A, B, C, G (excludes closer)	Add \$65	d. 80 HEIGHT	Add \$48	\$118
20 minute label	Add \$17	G90 Galvanized		
5/8" standard undercut	No Add	a. 68 HEIGHT	Add	\$354
StormPro Hurricane & Tornado Resistant Impact Protective Systems - FLUSH ONLY		b. 70 HEIGHT	Add	\$361
FBC approval FL# 40296		c. 72 HEIGHT	Add	\$367
Design pressure is +/- 227 psf		d. 80 HEIGHT	Add	\$373
Combined Hurricane and Tornado Label	Add \$154	Glass Lites - Factory Installed (prices include kit) & Replaceable Module - Field Installed		
		Non-fire rated 10"x10"	Add	\$4,544
		Fire Rated 10"x10"	Add	\$8,947
		Non-fire rated 4"x25"	Add	\$5,512
		Fire Rated 4"x25"	Add	\$10,473

M-12 KD FRAMES

	WIDTH	HEIGHT	4 THRU 6	6-1/8 THRU 7-7/8	8 THRU 9-7/8	10 THRU 11-7/8	12 THRU 14
SINGLE	30	68 - 70	\$1,429	\$1,459	\$1,503	\$1,584	\$1,646
		72	\$1,464	\$1,485	\$1,528	\$1,614	\$1,671
		80	\$1,535	\$1,557	\$1,594	\$1,658	\$1,712
	31 - 40	68 - 70	\$1,447	\$1,471	\$1,517	\$1,596	\$1,658
		72	\$1,482	\$1,497	\$1,542	\$1,626	\$1,683
		80	\$1,553	\$1,569	\$1,608	\$1,670	\$1,724
DOUBLE	60	68 - 70	\$1,535	\$1,558	\$1,605	\$1,670	\$1,730
		72	\$1,561	\$1,578	\$1,625	\$1,690	\$1,748
		80	\$1,651	\$1,674	\$1,711	\$1,754	\$1,812
	61 - 80	68 - 70	\$1,563	\$1,586	\$1,641	\$1,705	\$1,762
		72	\$1,589	\$1,606	\$1,661	\$1,725	\$1,780
		80	\$1,679	\$1,702	\$1,747	\$1,789	\$1,844

GENERAL INFORMATION

CURRIES M series frames are available double or single rabbit. Prices reflect hardware preparations for 1-3/4" doors. Refer to CURRIES Architectural Technical Data Manual for standard details and limitations. StormPro

M-14 KD CRS FRAMES

2" face unequal rabbit profile frames are standard.

2" face only, 4" head available. 8080 max.

Tagging and bundling	Add	\$6
12 ga. lintel channel reinforcement included in price.		
4" face head single - 4-5/8" min. depth	Add	\$57
4" face head double - 4-5/8" min. depth	Add	\$80
10 T anchors - included with WPS in head.		
12 WEWA Anchors	Add	\$382
Head anchors included in base price		

		A40	A60
A40 or A60 Galvaneal	Add	\$30	\$54
G90 Galvanized	Add		\$93

UNDERWRITERS LABORATORIES

Single frame	Add	\$29
Double frame	Add	\$58

WELDED ASSEMBLIES (3 SIDED FRAME)

Seam Weld Die Miter (KD)	Add	\$86
Full Weld Die Miter (KD)	Add	\$154

WS-32
StormPro™ 361 Shutter
Tornado-Resistant Prices
 May, 2024



FOR USE WITH CORBIN RUSSWIN FE6700 OR SARGENT FM6100

Storm Pro assemblies are door and frame assemblies which have been tested and comply with the FEMA P-361 (2021), FEMA P-320 (2021) and ICC 500 (2014/2020) guidelines for the design and construction of storm shelters and for use in safe rooms to provide inhabitants protection from tornados. Size and hardware restrictions apply to products published below at this time. All hardware "by others".

FLUSH DOORS

WIDTH	HEIGHT	14 GAUGE
26-30	30-68	\$5,501
31-36	68	\$5,756
37-40	68	\$5,871

OVERSIZED DOOR OPTIONS – Not available

Single door - 3'0" minimum height

Pair of doors - 3'0" minimum height

FLUSH DOOR ONLY

Seamless T Edge		Standard
Flush top cap		Standard
Closer Reinforcement		Add \$36
Concealed Multi-point Lock Prep		Standard
Continuous Hinge Prep		Add \$108
		A40 A60
A40 or A60 Galvaneal	Add	\$48 \$97
G90 Galvanized	Add	\$354
1/4" standard undercut		No Add

FIRE RATING - 4 SIDED ONLY

Underwriters Laboratories	ABCG	Add	\$65
20 minute U. L.		Add	\$17

M-14 GA. KD 4 SIDED FRAME*

	WIDTH	HEIGHT	4 THRU 6	6-1/8 THRU 7-7/8	8 THRU 9-7/8	10 THRU 11-7/8	12 THRU 14
SINGLE	26-30	30-68	\$1,474	\$1,487	\$1,539	\$1,687	\$1,757
	31-36	68	\$1,480	\$1,499	\$1,557	\$1,701	\$1,771
	37-40	68	\$1,480	\$1,499	\$1,557	\$1,701	\$1,771
DOUBLE	52-60	30-68	\$2,506	\$2,565	NA	NA	NA
	61-80	30-68	\$2,540	\$2,565	NA	NA	NA

*Optional 3 Sided Frame - single frames only Deduct \$293

*NOTE: Shutter frame must be welded.

Base double frame price includes 12 gauge mullion welded.

Double frame max. depth 7" for double rabbet; 6-1/2" for single rabbet.

See welded assemblies for corner welding prices.

NOTE: This product is manufactured offsite and ships separately.
 Call to verify lead-times and ship schedule.

Multi-point preps		Standard
Tagging and bundling		Add \$6
T-Anchors		Standard
WPS Anchors		Add \$382
EWA Anchors (head)		Standard
4" Face Head - 4-5/8" min. Depth		Add \$57
Glazing Bead on Shutter Frame	Per foot	Add \$15
		A40 A60
A40 or A60 Galvaneal	Add	\$40 \$71
G90 Galvanized	Add	\$124

WELDED ASSEMBLIES

Seam Weld	4-sided	Add	\$172
Full Weld	4-sided	Add	\$308
Seam Weld	3-sided	Add	\$86
Full Weld	3-sided	Add	\$154

FIRE RATING - 4 SIDED ONLY

Underwriters Laboratories		Add	\$29
---------------------------	--	-----	------

FOR USE WITH CORBIN RUSSWIN FE6700 OR SARGENT FM6100

Storm Pro assemblies are door and frame assemblies which have been tested and comply with the FEMA P-361 (2021), FEMA P-320 (2021) and ICC 500 (2014/2020) guidelines for the design and construction of storm shelters and for use in safe rooms to provide inhabitants protection from tornados. Size and hardware restrictions apply to products published below at this time. All hardware "by others".

FLUSH DOORS

WIDTH	HEIGHT	12 GAUGE
26-30	30-68	\$6,656
31-36	68	\$6,874
37-40	68	\$7,304

OVERSIZED DOOR OPTIONS – Not available
 Single door - 3'0" minimum height
 Pair of doors - 3'0" minimum height

FLUSH DOOR ONLY

Seamless T Edge		Standard
Flush top cap		Standard
Closer Reinforcement		Add \$36
Concealed Multi-point Lock Prep		Standard
Continuous Hinge Prep		Add \$108
		A40 A60
A40 or A60 Galvaneal	Add	\$48 \$97
G90 Galvanized	Add	\$354
1/4" standard undercut		No Add

FIRE RATING - 4 SIDED ONLY

Underwriters Laboratories	ABCG	Add	Less CL \$65
20 minute U. L.		Add	\$17

M-12 GA. KD 4 SIDED FRAME*

	WIDTH	HEIGHT	4 THRU 6	6-1/8 THRU 7-7/8	8 THRU 9-7/8	10 THRU 11-7/8	12 THRU 14
SINGLE	26-30	30-68	\$1,959	\$1,969	\$2,028	\$2,178	\$2,243
	31-36	68	\$1,977	\$1,997	\$2,056	\$2,204	\$2,273
	37-40	68	\$1,977	\$1,997	\$2,056	\$2,204	\$2,273
DOUBLE	52-60	30-68	\$3,040	\$3,103	NA	NA	NA
	61-80	30-68	\$3,104	\$3,161	NA	NA	NA

*Optional 3 Sided Frame - single frames only Deduct \$293

*NOTE: Shutter frame must be welded.
 Base double frame prices includes 12 gauge mullion welded.
 Double frame max. depth 7" for double rabbet; 6-1/2" for single rabbet.
 See welded assemblies for corner welding prices.

NOTE: This product is manufactured offsite and ships separately.
 Call to verify lead-times and ship schedule.

FIRE RATING - N/A

Multi-point preps		Standard
Tagging and bundling		Add \$6
T-Anchors		Standard
WPS Anchors		Add \$382
EWA Anchors (head)		Standard
4" Face Head - 4-5/8" min. Depth		Add \$57
Glazing Bead on Shutter Frame	Per foot	Add \$15
		A40 A60
A60 Galvaneal	Add	\$40 \$71
G90 Galvanized	Add	\$124

WELDED ASSEMBLIES

Seam Weld	4-sided	Add	\$172
Full Weld	4-sided	Add	\$308
Seam Weld	3-sided	Add	\$86
Full Weld	3-sided	Add	\$154

FIRE RATING - 4 SIDED ONLY

Underwriters Laboratories		Add	\$29
---------------------------	--	-----	------