

# Series 1100

## Electric Hinges/Pivots

---

Hager  
IVES  
McKinney  
BEST  
PBB  
Bommer  
Rixson  
ABH  
and more

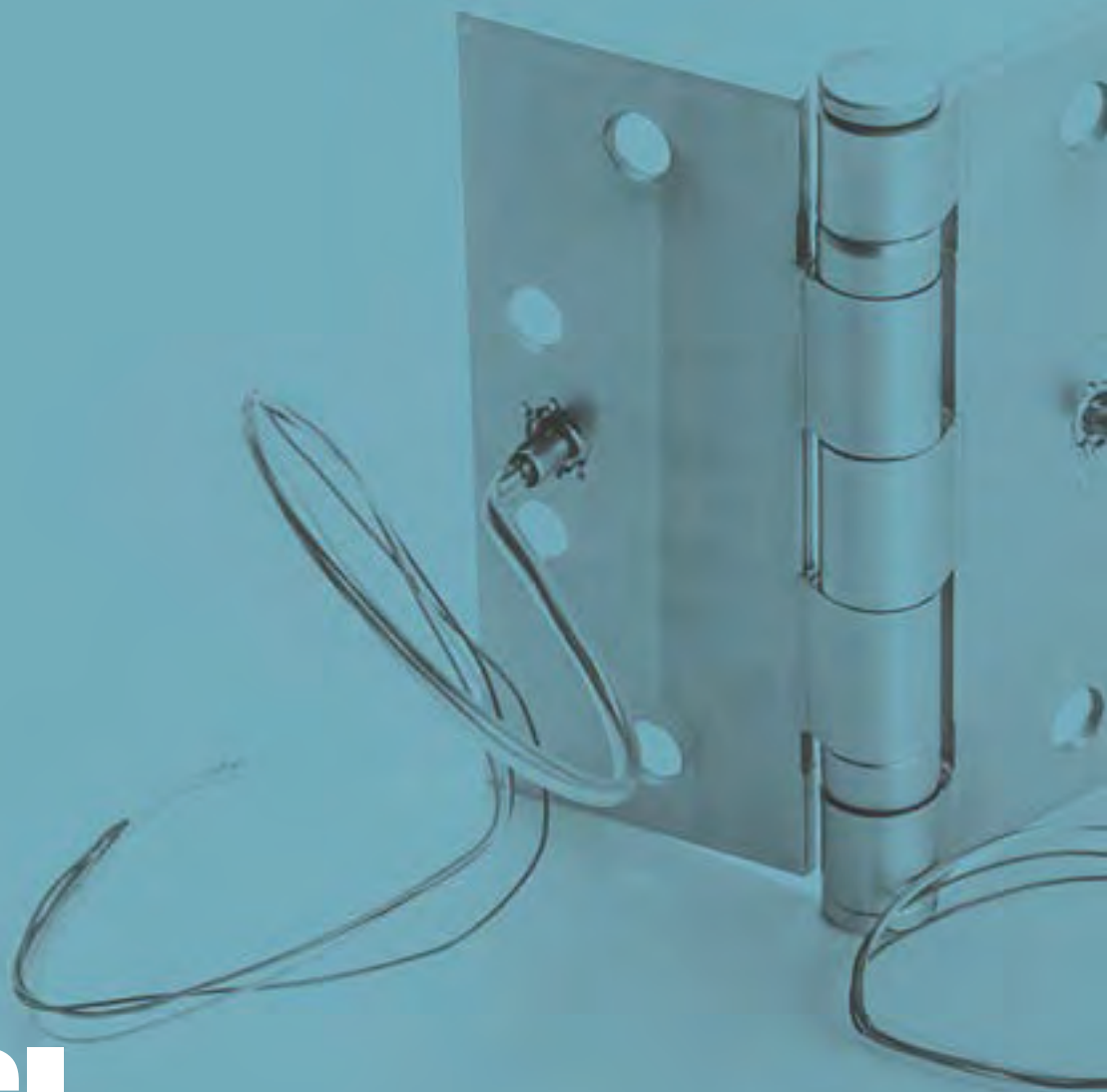

# ACSI

2720 Clark Avenue  
St. Louis, MO 63103  
(314) 652-5588  
(314) 652-2090 FAX

[www.acsi-inc.com](http://www.acsi-inc.com)

1-800-753-5558

# Series 1100 | Electric Hinges/Pivots

ACSI Series 1100 Electric Hinges/Pivots are designed for doors that require concealed low voltage power transfer, concealed electric monitoring or concealed low voltage power transfer with monitoring. ACSI Series 1100 products are UL Listed and carry a full one-year warranty.

## Manufacturers

**Hager, IVES, McKinney, BEST, PBB, Bommer, Rixson, ABH, Dorma, Design Hardware, Don-Jo and more\***

\*Consult factory for manufacturers not listed

- All IVES electric hinges supplied with Allegion connectors
- All McKinney electric hinges supplied with ASSA connectors

## Options

- Custom wire lead lengths
- Universal Molex® Connectors
- Connectors available in Hager, ASSA or IVES specification

## Features

- UL listed (UL File BP6073)
- UL Fire Rating on steel and stainless electric hinges (UL File R22305)
- Provide current transfer to electrified mortise or cylindrical locks, exit devices with electric latch retraction, electric strikes (pair of doors), & locks with monitoring/request to exit switches
- UL Rated for 3.5 amp continuous and a 16amp pulse
- Standard weight or heavy weight models
- Steel, brass, or stainless steel hinges
- Available in five knuckle and three knuckle hinges
- All architectural finishes in sizes 4x4 through 6x6
- Hinges/Pivots in stock for same day shipments

## Notes

- Electric hinge must be placed in the center position only.
- ACSI requires NON-NRP hinges for modification. Hinge pin is not field removable after modification.
- ACSI part #302-03-03 mortar guard is required for all application with grout-filled frames. Failure to install mortar guard will void the electric hinge warranty.
- All "specialty hinges" not previously modified by ACSI will include a onetime \$250 design/engineering fee plus the hinge modification price.

## Comparison Chart

| ACSI | BEST    | HAGER | McKINNEY | IVES |
|------|---------|-------|----------|------|
| 1104 | CE-54   | ETW-4 | CC-4     | TW4  |
| 1106 | CE-56   | ETW-6 | CC-6     | TW6  |
| 1108 | CE-58   | ETW-8 | CC-8     | TW8  |
| 1110 | CS      | EMN   | CS       | MON  |
| 1114 | CECS-54 | ETM-4 | CSCC-4   | TW4M |
| 1116 | CECS-56 | ETM-6 | CSCC-6   | TW6M |
| 1118 | CECS-58 | ETM-8 | CSCC-8   | TW8M |

## Models Available

| Model   | Description  |
|---------|--|
| 1102    | Concealed electric through-wire (2 wire, 22ga)                   |
| 1104    | Concealed electric through-wire (4 wire, 26/28ga)                |
| 1106    | Concealed electric through-wire (6 wire, 26/28ga)                |
| 1108    | Concealed electric through-wire (8 wire, 26/28ga)                |
| 1100-10 | Concealed electric through-wire (10 wire, 26/28ga)               |
| 1100-12 | Concealed electric through-wire (12 wire, 26/28ga)               |
| 1102x4  | Concealed electric through-wire (2 wire, 22ga x 4 wire, 26/28ga) |
| 1182*   | Concealed electric through-wire (2 wire, 18ga)                   |
| 1182x4* | Concealed electric through-wire (2 wire, 18ga x 4 wire, 26/28ga) |
| 1182x6* | Concealed electric through-wire (2 wire, 18ga x 6 wire, 26/28ga) |
| 1110    | Concealed electric monitor                                       |
| 1114    | Concealed electric monitor and through-wire (4 wire, 26/28ga)    |
| 1116    | Concealed electric monitor and through-wire (6 wire, 26/28ga)    |
| 1118    | Concealed electric monitor and through-wire (8 wire, 26/28ga)    |

\* Not available in pivot modification

## How to Order

| Manufacturer's Model     | ACSI Model |
|--------------------------|------------|
| BEST FBB179 4.5x4.5 26D  | 1104       |
| Hager BB1279 5.0x4.5 10B | 1108       |
| Rixson M19 US26 LH       | 1110       |

## Electrical Specifications

### Concealed electric through-wire

- 22ga, 26ga, 28ga conductors, 12 inch wire lead length both sides
  - 3.5A continuous @ 50VAC/VDC
  - 16A pulse @ 50VAC/DC
    - 400msec maximum pulse-width
    - 10sec minimum off-time between pulses
- 18ga conductors, 12 inch wire lead length both sides
  - 10A continuous @ 50VAC/VDC
  - 20A inrush @ 50VAC/DC for 4sec

### Concealed electric monitor

- 0.5A @ 30VDC



# SERIES 1100

## Electric Hinges/Pivots

Below pricing for hinges supplied by ACSI. Consult factory for hinges not listed.

| Standard Weight, 5 Knuckle, Steel<br>4 wire |                 |      | BB1279 | 5BB1  | TA2714 | FBB179 |
|---|-----------------|------|--------|-------|--------|--------|
| 4.0x4.0                                     | 26D 652         | 1104 | \$212  | \$230 | \$230  | \$212  |
|   | 10A/10B 641/640 |      | 224    | 244   | 244    | 224    |
|   | BLK 693         |      | 224    | 244   | 244    | 224    |
|   | 3 632           |      | 224    | 244   | 244    | 224    |
|   | 26 651          |      | 224    | 244   | 244    | 224    |
|   | 10 639          |      | 224    | 244   | 244    | 224    |
|   | 4 633           |      | 224    | 244   | 244    | 224    |
|   | P/BSP 600       |      | 224    | 244   | 244    | 224    |
| 4.5x4.0                                     | 26D 652         | 1104 | \$206  | \$224 | \$224  | \$206  |
|   | 10A/10B 641/640 |      | 224    | 244   | 244    | 224    |
|   | BLK 693         |      | 224    | 244   | 244    | 224    |
|   | 3 632           |      | 224    | 244   | 244    | 224    |
|   | 26 651          |      | 224    | 244   | 244    | 224    |
|   | 10 639          |      | 224    | 244   | 244    | 224    |
|   | 4 633           |      | 224    | 244   | 244    | 224    |
|   | P/BSP 600       |      | 224    | 244   | 244    | 224    |
| 4.5x4.5                                     | 26D 652         | 1104 | \$186  | \$186 | \$186  | \$186  |
|   | 10A/10B 641/640 |      | 190    | 208   | 208    | 190    |
|   | BLK 693         |      | 190    | 208   | 208    | 190    |
|   | 3 632           |      | 190    | 208   | 208    | 190    |
|   | 26 651          |      | 190    | 208   | 208    | 190    |
|   | 10 639          |      | 190    | 208   | 208    | 190    |
|   | 4 633           |      | 190    | 208   | 208    | 190    |
|   | P/BSP 600       |      | 190    | 208   | 208    | 190    |
| 5.0x4.0                                     | 26D 652         | 1104 | \$224  | \$244 | \$244  | \$224  |
|   | 10A/10B 641/640 |      | 240    | 262   | 262    | 240    |
|   | BLK 693         |      | 240    | 262   | 262    | 240    |
|   | 3 632           |      | 240    | 262   | 262    | 240    |
|   | 26 651          |      | 240    | 262   | 262    | 240    |
|   | 10 639          |      | 240    | 262   | 262    | 240    |
|   | 4 633           |      | 240    | 262   | 262    | 240    |
|   | P/BSP 600       |      | 240    | 262   | 262    | 240    |

# Series 1100 | Electric Hinges/Pivots

| Standard Weight, 5 Knuckle, Steel<br>4 wire |                 |      |  | BB1279 | 5BB1   | TA2714  | FBB179 |
|---|-----------------|------|--|--------|--------|---------|--------|
| 5.0X4.5                                     | 26D 652         | 1104 |  | \$216  | \$234  | \$234   | \$216  |
|   | 10A/10B 641/640 |      |  | 234    | 254    | 254     | 234    |
|   | BLK 693         |      |  | 234    | 254    | 254     | 234    |
|   | 3 632           |      |  | 234    | 254    | 254     | 234    |
|   | 26 651          |      |  | 234    | 254    | 254     | 234    |
|   | 10 639          |      |  | 234    | 254    | 254     | 234    |
|   | 4 633           |      |  | 234    | 254    | 254     | 234    |
|   | P/BSP 600       |      |  | 234    | 254    | 254     | 234    |
| 5.0x5.0                                     | 26D 652         | 1104 |  | \$220  | \$240  | \$240   | \$220  |
|   | 10A/10B 641/640 |      |  | 234    | 254    | 254     | 234    |
|   | BLK 693         |      |  | 234    | 254    | 254     | 234    |
|   | 3 632           |      |  | 234    | 254    | 254     | 234    |
|   | 26 651          |      |  | 234    | 254    | 254     | 234    |
|   | 10 639          |      |  | 234    | 254    | 254     | 234    |
|   | 4 633           |      |  | 234    | 254    | 254     | 234    |
|   | P/BSP 600       |      |  | 234    | 254    | 254     | 234    |
| Heavy Weight, 5 Knuckle, Steel<br>4 wire    |                 |      |  | BB1168 | 5BB1HW | T4A3786 | FBB168 |
| 4.5X4.0                                     | 26D 652         | 1104 |  | \$244  | \$266  | \$266   | \$244  |
|   | 10A/10B 641/640 |      |  | 262    | 286    | 286     | 262    |
|   | BLK 693         |      |  | 262    | 286    | 286     | 262    |
|   | 3 632           |      |  | 262    | 286    | 286     | 262    |
|   | 26 651          |      |  | 262    | 286    | 286     | 262    |
|   | 10 639          |      |  | 262    | 286    | 286     | 262    |
|   | 4 633           |      |  | 262    | 286    | 286     | 262    |
|   | P/BSP 600       |      |  | 262    | 286    | 286     | 262    |
| 4.5X4.5                                     | 26D 652         | 1104 |  | \$236  | \$256  | \$256   | \$236  |
|   | 10A/10B 641/640 |      |  | 258    | 280    | 280     | 258    |
|   | BLK 693         |      |  | 258    | 280    | 280     | 258    |
|   | 3 632           |      |  | 258    | 280    | 280     | 258    |
|   | 26 651          |      |  | 258    | 280    | 280     | 258    |
|   | 10 639          |      |  | 258    | 280    | 280     | 258    |
|   | 4 633           |      |  | 258    | 280    | 280     | 258    |
|   | P/BSP 600       |      |  | 258    | 280    | 280     | 258    |

# Series 1100 | Electric Hinges

| Heavy Weight, 5 Knuckle, Steel<br>4 wire                          |                 |      | BB1168 | 5BB1HW | T4A3786 | FBB168 |
|---|-----------------|------|--------|--------|---------|--------|
| 5.0x4.5   | 26D 652         | 1104 | \$246  | \$268  | \$268   | \$246  |
|   | 10A/10B 641/640 |      | 270    | 294    | 294     | 270    |
|   | BLK 693         |      | 270    | 294    | 294     | 270    |
|   | 3 632           |      | 270    | 294    | 294     | 270    |
|   | 26 651          |      | 270    | 294    | 294     | 270    |
|   | 10 639          |      | 270    | 294    | 294     | 270    |
|   | 4 633           |      | 270    | 294    | 294     | 270    |
|   | P/BSP 600       |      | 270    | 294    | 294     | 270    |
|   |                 |      |        |        |         |        |
| 5.0x5.0   | 26D 652         | 1104 | \$252  | \$274  | \$274   | \$252  |
|   | 10A/10B 641/640 |      | 270    | 294    | 294     | 270    |
|   | BLK 693         |      | 270    | 294    | 294     | 270    |
|   | 3 632           |      | 270    | 294    | 294     | 270    |
|   | 26 651          |      | 270    | 294    | 294     | 270    |
|   | 10 639          |      | 270    | 294    | 294     | 270    |
|   | 4 633           |      | 270    | 294    | 294     | 270    |
|   | P/BSP 600       |      | 270    | 294    | 294     | 270    |
|   |                 |      |        |        |         |        |
| Standard Weight, 5 Knuckle, Brass<br>or Stainless Steel<br>4 wire |                 |      | BB1191 | 5BB1   | TA2314  | FBB191 |
| 4.5x4.0   | 26D 626         | 1104 | \$242  | \$264  | \$264   | \$242  |
|   | 10B 613         |      | 246    | 268    | 268     | 246    |
|   | 3 605           |      | 246    | 268    | 268     | 246    |
|   | 26 625          |      | 246    | 268    | 268     | 246    |
|   | 10 612          |      | 246    | 268    | 268     | 246    |
|   | 4 606           |      | 246    | 268    | 268     | 246    |
|   | 32 629          |      | 308    | 334    | 334     | 308    |
|   | 32D 630         |      | 288    | 312    | 312     | 288    |
|   |                 |      |        |        |         |        |
| 4.5x4.5   | 26D 626         | 1104 | \$238  | \$260  | \$260   | \$238  |
|   | 10B 613         |      | 246    | 268    | 268     | 246    |
|   | 3 605           |      | 246    | 268    | 268     | 246    |
|   | 26 625          |      | 246    | 268    | 268     | 246    |
|   | 10 612          |      | 246    | 268    | 268     | 246    |
|   | 4 606           |      | 246    | 268    | 268     | 246    |
|   | 32 629          |      | 298    | 326    | 326     | 298    |
|   | 32D 630         |      | 278    | 304    | 304     | 278    |
|   |                 |      |        |        |         |        |
| 5.0x4.5   | 26D 626         | 1104 | \$270  | \$294  | \$294   | \$270  |
|   | 10B 613         |      | 284    | 310    | 310     | 284    |
|   | 3 605           |      | 284    | 310    | 310     | 284    |
|   | 26 625          |      | 284    | 310    | 310     | 284    |
|   | 10 612          |      | 276    | 300    | 300     | 276    |
|   | 4 606           |      | 276    | 300    | 300     | 276    |
|   | 32 629          |      | 308    | 334    | 334     | 308    |
|   | 32D 630         |      | 292    | 318    | 318     | 292    |
|   |                 |      |        |        |         |        |

1-800-753-5558

# Series 1100 | Electric Hinges

| Standard Weight, 5 Knuckle, Brass<br>or Stainless Steel<br>4 wire |         |      | BB1191 | 5BB1   | TA2314  | FBB191 |
|---|---------|------|--------|--------|---------|--------|
| 5.0x5.0   | 26D 626 | 1104 | \$270  | \$294  | \$294   | \$270  |
|   | 10B 613 |      | 284    | 310    | 310     | 284    |
|   | 3 605   |      | 284    | 310    | 310     | 284    |
|   | 26 625  |      | 284    | 310    | 310     | 284    |
|   | 10 612  |      | 276    | 300    | 300     | 276    |
|   | 4 606   |      | 276    | 300    | 300     | 276    |
|   | 32 629  |      | 316    | 344    | 344     | 316    |
|   | 32D 630 |      | 306    | 332    | 332     | 306    |
|   |         |      |        |        |         |        |
| Heavy Weight, 5 Knuckle, Brass<br>or Stainless Steel<br>4 wire    |         |      | BB1199 | 5BB1HW | T4A3386 | FBB199 |
| 4.5x4.0   | 26D 626 | 1104 | \$290  | \$316  | \$316   | \$290  |
|   | 10B 613 |      | 300    | 328    | 328     | 300    |
|   | 3 605   |      | 300    | 328    | 328     | 300    |
|   | 26 625  |      | 300    | 328    | 328     | 300    |
|   | 10 612  |      | 300    | 328    | 328     | 300    |
|   | 4 606   |      | 300    | 328    | 328     | 300    |
|   | 32 629  |      | 346    | 376    | 376     | 346    |
|   | 32D 630 |      | 324    | 352    | 352     | 324    |
|   |         |      |        |        |         |        |
| 4.5x4.5   | 26D 626 | 1104 | \$290  | \$316  | \$316   | \$290  |
|   | 10B 613 |      | 300    | 328    | 328     | 300    |
|   | 3 605   |      | 300    | 328    | 328     | 300    |
|   | 26 625  |      | 300    | 328    | 328     | 300    |
|   | 10 612  |      | 300    | 328    | 328     | 300    |
|   | 4 606   |      | 300    | 328    | 328     | 300    |
|   | 32 629  |      | 346    | 376    | 376     | 346    |
|   | 32D 630 |      | 314    | 342    | 342     | 314    |
|   |         |      |        |        |         |        |
| 5.0x4.5   | 26D 626 | 1104 | \$300  | \$328  | \$328   | \$300  |
|   | 10B 613 |      | 318    | 346    | 346     | 318    |
|   | 3 605   |      | 318    | 346    | 346     | 318    |
|   | 26 625  |      | 318    | 346    | 346     | 318    |
|   | 10 612  |      | 318    | 346    | 346     | 318    |
|   | 4 606   |      | 318    | 346    | 346     | 318    |
|   | 32 629  |      | 368    | 400    | 400     | 368    |
|   | 32D 630 |      | 332    | 362    | 362     | 332    |
|   |         |      |        |        |         |        |
| 5.0x5.0   | 26D 626 | 1104 | \$300  | \$328  | \$328   | \$300  |
|   | 10B 613 |      | 318    | 346    | 346     | 318    |
|   | 3 605   |      | 318    | 346    | 346     | 318    |
|   | 26 625  |      | 318    | 346    | 346     | 318    |
|   | 10 612  |      | 318    | 346    | 346     | 318    |
|   | 4 606   |      | 318    | 346    | 346     | 318    |
|   | 32 629  |      | 368    | 400    | 400     | 368    |
|   | 32D 630 |      | 340    | 372    | 372     | 340    |

# Series 1100 | Electric Hinges

| Standard Weight, 3 Knuckle, Steel<br>4 wire |                 |      | AB700 | 3CB1   | TA714 | CB1900 |
|---|-----------------|------|-------|--------|-------|--------|
| 4.5x4.5                                     | 26D 652         | 1104 | \$218 | \$238  | \$238 | \$218  |
|   | 10A/10B 641/640 |      | 234   | 254    | 254   | 234    |
|   | BLK 693         |      | 234   | 254    | 254   | 234    |
|   | 3 632           |      | 234   | 254    | 254   | 234    |
|   | 26 651          |      | 234   | 254    | 254   | 234    |
|   | 10 639          |      | 228   | 250    | 250   | 228    |
|   | 4 633           |      | 228   | 250    | 250   | 228    |
|   | P/BSP 600       |      | 228   | 250    | 250   | 228    |
| 5.0x4.5                                     | 26D 652         | 1104 | \$234 | \$254  | \$254 | \$234  |
|   | 10A/10B 641/640 |      | 242   | 264    | 264   | 242    |
|   | BLK 693         |      | 242   | 264    | 264   | 242    |
|   | 3 632           |      | 242   | 264    | 264   | 242    |
|   | 26 651          |      | 242   | 264    | 264   | 242    |
|   | 10 639          |      | 238   | 260    | 260   | 238    |
|   | 4 633           |      | 238   | 260    | 260   | 238    |
|   | P/BSP 600       |      | 238   | 260    | 260   | 238    |
| 5.0x5.0                                     | 26D 652         | 1104 | \$234 | \$254  | \$254 | \$234  |
|   | 10A/10B 641/640 |      | 242   | 264    | 264   | 242    |
|   | BLK 693         |      | 242   | 264    | 264   | 242    |
|   | 3 632           |      | 242   | 264    | 264   | 242    |
|   | 26 651          |      | 242   | 264    | 264   | 242    |
|   | 10 639          |      | 238   | 260    | 260   | 238    |
|   | 4 633           |      | 238   | 260    | 260   | 238    |
|   | P/BSP 600       |      | 238   | 260    | 260   | 238    |
| Heavy Weight, 3 Knuckle, Steel<br>4 wire    |                 |      | AB750 | 3CB1HW | TA786 | CB1901 |
| 4.5x4.5                                     | 26D 652         | 1104 | \$292 | \$318  | \$318 | \$292  |
|   | 10A/10B 641/640 |      | 310   | 338    | 338   | 310    |
|   | BLK 693         |      | 310   | 338    | 338   | 310    |
|   | 3 632           |      | 310   | 338    | 338   | 310    |
|   | 26 651          |      | 310   | 338    | 338   | 310    |
|   | 10 639          |      | 310   | 338    | 338   | 310    |
|   | 4 633           |      | 310   | 338    | 338   | 310    |
|   | P/BSP 600       |      | 310   | 338    | 338   | 310    |
| 5.0x4.5                                     | 26D 652         | 1104 | \$310 | \$338  | \$338 | \$310  |
|   | 10A/10B 641/640 |      | 326   | 354    | 354   | 326    |
|   | BLK 693         |      | 326   | 354    | 354   | 326    |
|   | 3 632           |      | 326   | 354    | 354   | 326    |
|   | 26 651          |      | 326   | 354    | 354   | 326    |
|   | 10 639          |      | 326   | 354    | 354   | 326    |
|   | 4 633           |      | 326   | 354    | 354   | 326    |
|   | P/BSP 600       |      | 326   | 354    | 354   | 326    |

# Series 1100 | Electric Hinges

| Standard Weight, 3 Knuckle, Brass or Stainless Steel<br>4 wire |         |      | AB800 | 3CB1   | TA314 | CB1960 |
|--|---------|------|-------|--------|-------|--------|
| 4.5x4.5  | 26D 626 | 1104 | \$288 | \$312  | \$312 | \$288  |
|  | 10B 613 |      | 346   | 376    | 376   | 346    |
|  | 3 605   |      | 346   | 376    | 376   | 346    |
|  | 26 625  |      | 346   | 376    | 376   | 346    |
|  | 10 612  |      | 288   | 312    | 312   | 288    |
|  | 32 629  |      | 326   | 354    | 354   | 326    |
|  | 32D 630 |      | 326   | 354    | 354   | 326    |
| 5.0x4.5  | 26D 626 | 1104 | \$314 | \$342  | \$342 | \$314  |
|  | 10B 613 |      | 368   | 400    | 400   | 368    |
|  | 3 605   |      | 368   | 400    | 400   | 368    |
|  | 26 625  |      | 368   | 400    | 400   | 368    |
|  | 10 612  |      | 314   | 342    | 342   | 314    |
|  | 32 629  |      | 358   | 390    | 390   | 358    |
|  | 32D 630 |      | 358   | 390    | 390   | 358    |
| 5.0x5.0  | 26D 626 | 1104 | \$314 | \$342  | \$342 | \$314  |
|  | 10B 613 |      | 334   | 364    | 364   | 334    |
|  | 3 605   |      | 334   | 364    | 364   | 334    |
|  | 26 625  |      | 334   | 364    | 364   | 334    |
|  | 10 612  |      | 314   | 342    | 342   | 314    |
|  | 32 629  |      | 358   | 390    | 390   | 358    |
|  | 32D 630 |      | 358   | 390    | 390   | 358    |
| Heavy Weight, 3 Knuckle, Brass or Stainless Steel<br>4 wire    |         |      | AB850 | 3CB1HW | TA386 | CB1961 |
| 4.5x4.5  | 26D 626 | 1104 | \$320 | \$350  | \$350 | \$320  |
|  | 10B 613 |      | 380   | 412    | 412   | 380    |
|  | 3 605   |      | 380   | 412    | 412   | 380    |
|  | 26 625  |      | 380   | 412    | 412   | 380    |
|  | 10 612  |      | 320   | 350    | 350   | 320    |
|  | 32 629  |      | 372   | 406    | 406   | 372    |
|  | 32D 630 |      | 372   | 406    | 406   | 372    |
| 5.0x4.5  | 26D 626 | 1104 | \$356 | \$388  | \$388 | \$356  |
|  | 10B 613 |      | 412   | 450    | 450   | 412    |
|  | 3 605   |      | 412   | 450    | 450   | 412    |
|  | 26 625  |      | 412   | 450    | 450   | 412    |
|  | 10 612  |      | 356   | 388    | 388   | 356    |
|  | 32 629  |      | 396   | 432    | 432   | 396    |
|  | 32D 630 |      | 396   | 432    | 432   | 396    |
| 5.0x5.0  | 26D 626 | 1104 | \$356 | \$388  | \$388 | \$356  |
|  | 10B 613 |      | 412   | 450    | 450   | 412    |
|  | 3 605   |      | 412   | 450    | 450   | 412    |
|  | 26 625  |      | 412   | 450    | 450   | 412    |
|  | 10 612  |      | 356   | 388    | 388   | 356    |
|  | 32 629  |      | 396   | 432    | 432   | 396    |
|  | 32D 630 |      | 396   | 432    | 432   | 396    |



## Series 1100 | Electric Hinges Options (ADD TO 1104 LIST PRICE)

| Model      | Hinge Option Description   | List Price      |
|------------|--|-----------------|
| 1106       | Concealed electric through-wire (6 wire, 26/28 ga)                               | \$66            |
| 1108       | Concealed electric through-wire (8 wire, 26/28 ga)                               | 70              |
| 1100-10    | Concealed electric through-wire (10 wire, 26/28 ga)                              | 140             |
| 1100-12    | Concealed electric through-wire (12 wire, 26/28 ga)                              | 150             |
| 1102       | Concealed electric through-wire (2 wire, 22 ga)                                  | 60              |
| 1102x4     | Concealed electric through-wire (2 wire, 22 ga x 4 wire, 26/28 ga)               | 110             |
| 1182       | Concealed electric through-wire (2 wire, 18 ga)                                  | 70              |
| 1182x4     | Concealed electric through-wire (2 wire, 18 ga x 4 wire, 26/28 ga)               | 120             |
| 1182x6     | Concealed electric through-wire (2 wire, 18 ga x 6 wire, 26/28 ga)               | 140             |
| 1110       | Concealed electric monitor   | 24              |
| 1114       | Concealed electric through-wire + monitor (4 wire)                               | 186             |
| 1116       | Concealed electric through-wire + monitor (6 wire)                               | 220             |
| 1118       | Concealed electric through-wire + monitor (8 wire)                               | 234             |
| 1100-PG    | Concealed electric through-wire (2 wire + ground, 18 ga) for 115V power transfer | 450             |
| ES         | Exposed electric switch (1 switch)   | Consult Factory |
| RC         | Radius corner hinges   | 30              |
| L          | Long wire leads  | Consult Factory |
| 302 -03-03 | 7" Hinge mortar guard  | 44              |

**Note:** Consult factory for Swing Clear, Wide Throw, Half Mortise, Half Surface, Raised Barrel, Hospital Tips, and all other hinges not listed for price and availability.

### Electric Pivots

| Pivot | Finish                 | Model     | List Price |
|-------|------------------------|-----------|------------|
| M19   | 26D, 26, 10B, 3, 10, 4 | 1102/1104 | \$660      |
| M19   | 26D, 26, 10B, 3, 10, 4 | 1110      | 700        |
| M19   | 26D, 26, 10B, 3, 10, 4 | 1108      | 680        |

### Electric Hinges/Pivots Modifications

**Below pricing for modifications to distributor supplied hinges.**

| Model   | Hinge Option Description   | List Price |
|---------|--|------------|
| 1104    | Concealed electric through-wire (4 wire, 26/28 ga)                 | \$184      |
| 1106    | Concealed electric through-wire (6 wire, 26/28 ga)                 | 240        |
| 1108    | Concealed electric through-wire (8 wire, 26/28 ga)                 | 250        |
| 1100-10 | Concealed electric through-wire (10 wire, 26/28 ga)                | 300        |
| 1100-12 | Concealed electric through-wire (12 wire, 26/28 ga)                | 320        |
| 1102    | Concealed electric through-wire (2 wire, 22 ga)                    | 230        |
| 1102x4  | Concealed electric through-wire (2 wire, 22 ga x 4 wire, 26/28 ga) | 290        |
| 1182    | Concealed electric through-wire (2 wire, 18 ga)                    | 250        |
| 1182x4  | Concealed electric through-wire (2 wire, 18 ga x 4 wire, 26/28 ga) | 300        |
| 1182x6  | Concealed electric through-wire (2 wire, 18 ga x 6 wire, 26/28 ga) | 320        |
| 1110    | Concealed electric monitor   | 190        |
| 1114    | Concealed electric through-wire + monitor (4 wire, 26/28 ga)       | 360        |
| 1116    | Concealed electric through-wire + monitor (6 wire, 26/28 ga)       | 400        |
| 1118    | Concealed electric through-wire + monitor (8 wire, 26/28 ga)       | 440        |

# Series 1100 | Electric Hinges/Pivots Modification Comparison Chart

| ACSI | BEST    | HAGER | IVES | McKINNEY |
|------|---------|-------|------|----------|
| 1104 | CE-54   | ETW-4 | TW4  | CC-4     |
| 1106 | CE-56   | ETW-6 | TW6  | CC-6     |
| 1108 | CE-58   | ETW-8 | TW8  | CC-8     |
| 1110 | CS      | EMN   | MON  | CS       |
| 1114 | CECS-54 | ETM-4 | TW4M | CSCC-4   |
| 1116 | CECS-56 | ETM-6 | TW6M | CSCC-6   |
| 1118 | CECS-58 | ETM-8 | TW8M | CSCC-8   |

## HOW TO ORDER (EXAMPLE)

| Hinge/Part Description | Modification |
|------------------------|--------------|
| FBB179 4.5x4.5 26D     | 1104         |
| BB1279 5.0X4.5 10B     | 1108         |
| M19-US26 LH            | 1110         |



WWW.ACSI-INC.COM  
 LIST PRICES EFFECTIVE  
 JANUARY 1, 2024

# Series 1200

## Quick Connect Systems

---



# ACSI

2720 Clark Avenue  
St. Louis, MO 63103  
(314) 652-5588  
(314) 652-2090 FAX

[www.acsi-inc.com](http://www.acsi-inc.com)

1-800-753-5558

# Series 1200 | Quick Connect Systems

ACSI Series 1200 Quick Connect Systems allow for trouble-free and time saving connections of electromechanical hardware openings. ACSI offers 3 types of connecting systems.

| Systems | Description   |
|---------|---|
| QC1     | ACSI Quick Connect System (Fits into a 3/8" door raceway) |
| QC2     | ASSA Connect System                                       |
| QC3     | Allegion Connect System                                   |

| QC1 ACSI Quick Connect System |   |        |           |
|-------------------------------|---|--------|-----------|
| Model                         | Description                                       | Length | Net Price |
| 5C54M                         | 5 Wire Power/Switch Harness, Male Connector 1 end | 54"    | \$20      |
| 5C120M                        | 5 Wire Power/Switch Harness, Male Connector 1 end | 120"   | \$30      |

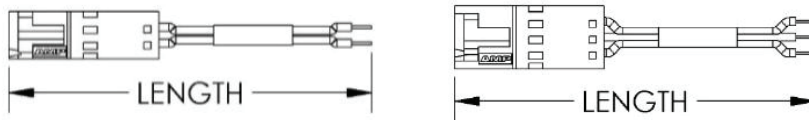

| QC2 ASSA Connect System   |          |                                 |           |        |           |  |
|---------------------------|----------|---------------------------------|-----------|--------|-----------|--|
| Model                     |          |                                 |           | Length | Net Price | Description  |
| Male Connectors Both Ends |          | Male Connector 1 End/Pins 1 End |           |        |           |  |
| 12C3MM                    | QC-C003  | 12C3MP                          | QC-C003P  | 3"     | \$14      | Connecting electric hinge with electric exit device                                    |
| 12C6MM                    | QC-C006  | 12C6MP                          | QC-C006P  | 6"     | \$15      |  |
| 12C12MM                   | QC-C012  | 12C12MP                         | QC-C012P  | 12"    | \$16      |  |
| 12C26MM                   | QC-C200  | 12C26MP                         | QC-C200P  | 26"    | \$17      | Connecting electric hinge through the door with electric lockset                       |
| 12C32MM                   | QC-C206  | 12C32MP                         | QC-C206P  | 32"    | \$18      |  |
| 12C38MM                   | QC-C300  | 12C38MP                         | QC-C300P  | 38"    | \$19      |  |
| 12C44MM                   | QC-C306  | 12C44MP                         | QC-C306P  | 44"    | \$20      |  |
| 12C50MM                   | QC-C400  | 12C50MP                         | QC-C400P  | 50"    | \$21      |  |
| 12C182MM                  | QC-C1500 | 12C182MP                        | QC-C1500P | 182"   | \$36      | Connecting electric hinge to power supply or through metal door with full or half lite |
|                           |          | 12C300MP                        | QC-C2500P | 300"   | \$48      |  |
|                           |          | 12C360MP                        | QC-C3000P | 360"   | \$54      |  |

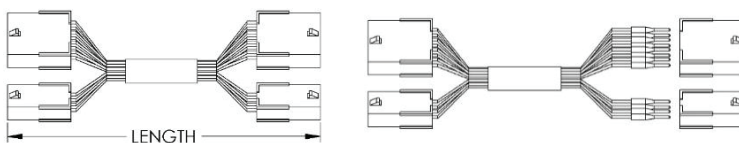

# Series 1200 | Quick Connect Systems

## QC3 Allegion Connect System CON

| Model                     |         |                                 |          | Length | Net Price   | Description  |
|---------------------------|---------|---------------------------------|----------|--------|-------------|--|
| Male Connectors Both Ends |         | Male Connector 1 End/Pins 1 End |          |        |             |  |
| 12C6MM-AL                 | CON-6   | 12C6MP-AL                       | CON-6P   | 6"     | <b>\$15</b> | Connecting electric hinge with electric exit device                                    |
| 12C12MM-AL                | CON-12  | 12C12MP-AL                      | CON-12P  | 12"    | <b>\$16</b> |  |
| 12C26MM-AL                | CON-26  | 12C26MP-AL                      | CON-26P  | 26"    | <b>\$17</b> | Connecting electric hinge through the door with electric lockset                       |
| 12C32MM-AL                | CON-32  | 12C32MP-AL                      | CON-32P  | 32"    | <b>\$18</b> |  |
| 12C38MM-AL                | CON-38  | 12C38MP-AL                      | CON-38P  | 38"    | <b>\$19</b> |  |
| 12C44MM-AL                | CON-44  | 12C44MP-AL                      | CON-44P  | 44"    | <b>\$20</b> |  |
| 12C50MM-AL                | CON-50  | 12C50MP-AL                      | CON-50P  | 50"    | <b>\$21</b> | Connecting electric hinge to power supply or through metal door with full or half lite |
| 12C192MM-AL               | CON-192 | 12C192MP-AL                     | CON-192P | 192"   | <b>\$42</b> |  |

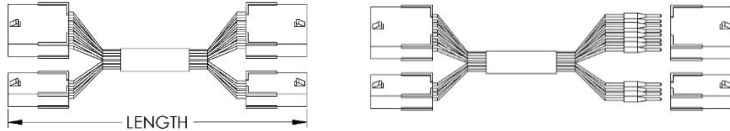

### ASSA Connector Positions

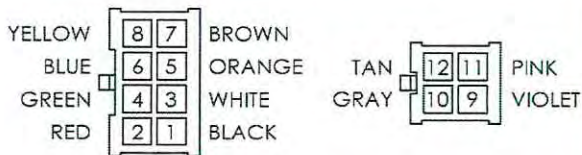

### Allegion Connector Positions

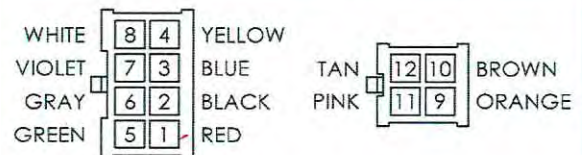

View from Back of Connectors (Terminal Insertion Side)



# Series 1300

## Door Controls

---

Mortise Keyswitches  
Pushbutton Switches  
Emergency Release  
Door Position Sensors  
Indicators  
Digital Keypads

# ACSI

2720 Clark Avenue  
St. Louis, MO 63103  
(314) 652-5588  
(314) 652-2090 FAX





[www.acsi-inc.com](http://www.acsi-inc.com)

1-800-753-5558

# Series 1300 | Door Controls

## Mortise Keyswitches



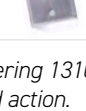



ACSI Series 1310 Mortise Keyswitches are designed to control electric locks, electric strikes, electric exit devices and a variety of other control applications. The keyswitches allow keying the electrically controlled openings to facility master key systems. DPDT contacts unless otherwise noted.

| Model    |   | Description   | List Price |
|----------|---|---|------------|
| 1310-1   |    | Single gang, wall mount   | \$156      |
| 1310-2   |    | Single gang, 2 LEDs (red & green), wall mount                                       | \$180      |
| 1310-4   |    | Narrow style, 1-3/4" frame mount  | \$168      |
| 1310-4-2 |   | Narrow style, 2 LEDs (red & green), 1-3/4" frame mount                              | \$190      |
| 1310-5   |  | Audible alarm, double gang, wall mount  | \$264      |
| 1310-5-2 |  | Audible alarm, double gang, 2 LEDs (red & green), wall mount                        | \$300      |
| 1310-6   |  | Single gang, 2 momentary switches, wall mount                                       | \$190      |
| 1310-7   |  | Single gang, 2 momentary switches, 1 LED (red or green), wall mount                 | \$210      |
| 1310-8   |  | Single gang, 2 momentary switches, 2 LEDs (red & green), wall mount                 | \$240      |
| 1310-9   |  | Adjustable time delay, single gang, 1 LED (red or green), SPDT contacts, wall mount | \$300      |

\*When ordering 1310 Keyswitches, specify momentary or maintained action.

## Pushbutton Switches

ACSI Series 1320 Pushbutton Switches provide a variety of functions for commercial and industrial door control applications. DPDT contacts unless otherwise noted.

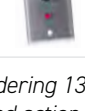
| Model    |   | Description   | List Price |
|----------|---|---|------------|
| 1320-1   |    | Single gang, wall mount   | \$120      |
| 1320-2   |    | Single gang, 1 LED (red or green), wall mount                                       | \$144      |
| 1320-3   |    | Single gang, 2 LEDs (red & green), wall mount                                       | \$168      |
| 1320-5   |    | Mushroom button, single gang, SPDT contacts, wall mount*                            | \$500      |
| 1320-5-2 |   | Mushroom button, single gang, 2 LEDs (red & green), SPDT contacts, wall mount*      | \$550      |
| 1320-6   |  | Narrow style, 1-3/4" frame mount  | \$144      |
| 1320-6-2 |  | Narrow style, 2 LEDs (red & green), 1-3/4" frame mount                              | \$180      |
| 1320-7   |  | Adjustable time delay, single gang, 1 LED (red or green), SPDT contacts, wall mount | \$250      |

\*When ordering 1320 Pushbuttons, specify momentary or maintained action.

# Series 1300 | Door Controls

## Emergency Release

ACSI 1330-3 Emergency Release provides manual emergency reporting; attractive/durable and finished in blue enamel.







### Features

- UL Listed
- California State Fire Marshall approved
- Normally open or normally closed contacts
- Key resettable for increased security
- Designed for indoor or outdoor use
- Mounts in a standard single gang box
- Comes packaged with two spare keys, mounting hardware and one glass break tube

| Model  |   | Description       | List Price   |
|--------|---|-------------------|--------------|
| 1330-3 |  | Emergency Release | <b>\$288</b> |

## Door Position Sensors

ACSI Series 1335 Door Position Sensors are used to confirm door position. Magnetic sensors mounted in the frame react to the proximity of the magnet mounted in the door. Pneumatic models also available for use in hazardous locations.

| Model  |   | Description                                 | List Price   |
|--------|---|---|--------------|
| 1335-1 |  | DPS Standard mortise, SPDT, NO/NC contacts  | <b>\$168</b> |
| 1335-2 |  | DPS ANSI, SPDT, NO/NC contacts              | <b>\$190</b> |
| 1335-3 |  | DPS 1" Recessed mount, SPDT, NO/NC contacts | <b>\$80</b>  |
| 1335-4 |  | DPS Standard mortise, DPDT, NO/NC contacts  | <b>\$182</b> |
| 1335-5 |  | DPS ANSI, DPDT, NO/NC contacts              | <b>\$200</b> |
| 1335-6 |  | DPS 1" Recessed mount, DPDT, NO/NC contacts | <b>\$110</b> |

## Indicators

ACSI Series 1340 Indicators provide visual or audible indication of system status.

| Model    |  | Description  | List Price   |
|----------|--|--|--------------|
| 1340-1   |    | Single gang, 1 LED (red or green), wall mount          | <b>\$72</b>  |
| 1340-1-2 |    | Single gang, 2 LEDs (red & green), wall mount          | <b>\$120</b> |
| 1340-2   |    | Audible alarm, single gang, wall mount                 | <b>\$144</b> |
| 1340-3   |    | High security audible alarm, single gang, wall mount   | <b>\$192</b> |
| 1341-1   |   | Narrow style, LED (Red or Green), 1 3/4" frame mount   | <b>\$72</b>  |
| 1341-2   |  | Narrow style, 2 LEDs (Red & Green), 1 3/4" frame mount | <b>\$120</b> |

## Electrical Specifications

### 1310/1320 Switches

- Contacts Rated 1A @ 30VDC

### 1330-3 Emergency Release Switch

- Separate NO/NC Outputs
- Can be wired for SPDT Contact Configuration
- Contacts Rated 1A @ 30VDC

### 1340-2 & 1340-3 Audible Alarm

- DC Voltage Range: 4V - 28V
- DC Current Range: 3mA - 16mA
- Frequency: 2900 Hz
- Sound Intensity: 64dB @ Min.V; 76dB @ Max.V

### Red/Green LED Indicator used with 1310/1320/1340 Controls

- 20mA @ 24VDC

1-800-753-5558



# Series 1300 | Door Controls





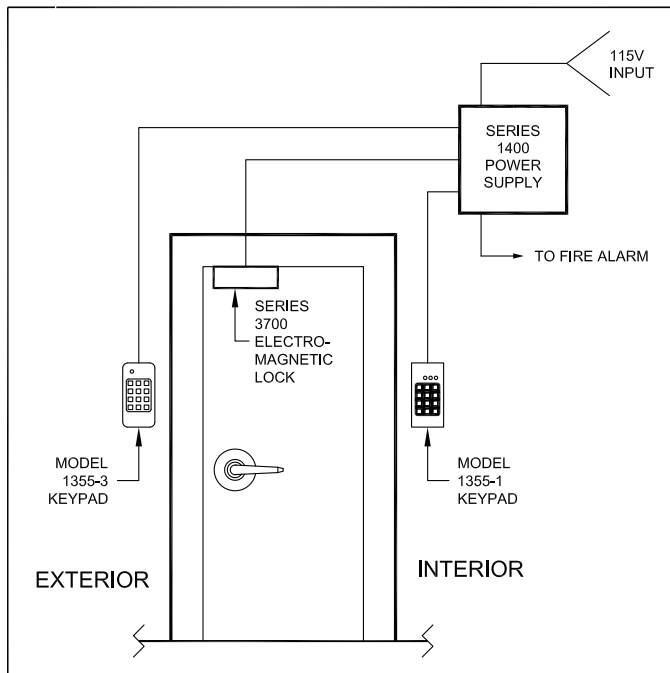

## Digital Keypads

ACSI Series 1355 Digital Keypads offer proven reliability for commercial, industrial and residential applications. The keypads are designed to control any electric locking device.

### Features

- Keypad programmable
- 10-30 VDC; 12-24VAC-auto adjusting (12-24VAC/DC for 1355-5)
- 120 user capability
- Codes can be 1 to 6 digits including repeated digits
- 1-90 sec. adjustable relock delay (1-255 sec. for 1355-6)
- LED status indicators (for all models except 1355-4)
- Request-to-exit switch input
- Main relay ON/OFF latching (toggle mode)
- Panic output (for all models except 1355-5 and 1355-6)
- Remote alarm panel interface capability
- Main relay: 5A, form C @ 24VDC with 10A surge (2A for 1355-3, 1355-4 and 1355-6)
- Non-volatile memory remembers codes and instructions when power is removed



| Model  |   | Description  | List Price     |
|--------|---|--|----------------|
| 1355-1 |    | Digital Indoor Keypad  | <b>\$264</b>   |
| 1355-2 |    | Weather Resistant Keypad   | <b>\$384</b>   |
| 1355-3 |    | Sealed Environmental Keypad <ul style="list-style-type: none"> <li>• Weather resistant, self-contained metal housing</li> <li>• Vandal resistant</li> <li>• Small design suitable for commercial, industrial and residential applications</li> </ul>   | <b>\$816</b>   |
| 1355-4 |   | Ruggedized Digital Keypad <ul style="list-style-type: none"> <li>• Weather resistant, self-contained metal housing</li> <li>• Vandal resistant</li> <li>• One piece housing suitable for wall, post or gooseneck mounting</li> <li>• Internal audible multi-status indicator (sounder)</li> <li>• Available in white or black</li> </ul>         | <b>\$816</b>   |
| 1355-5 |  | Mullion Digital Keypad <ul style="list-style-type: none"> <li>• Weather resistant for outdoor as well as indoor applications</li> <li>• Backlit hardened keys</li> <li>• Doorbell key with associated relay output</li> <li>• Narrow style suitable for aluminum door frame mounting</li> <li>• Available in bronze or satin aluminum</li> </ul> | <b>\$792</b>   |
| 1355-6 |  | Indoor/Outdoor Backlit Keypad <ul style="list-style-type: none"> <li>• Weather resistant</li> <li>• Illuminated backlit hardened keys</li> <li>• Flush mount design</li> <li>• Includes audible indicator (sounder)</li> </ul>   | <b>\$540</b>   |
| 1355-7 |  | Harsh Environment Keypad <ul style="list-style-type: none"> <li>• Vandal and weather resistant case</li> <li>• Indoor/outdoor applications</li> <li>• Touch sensitive flat key design</li> <li>• 12/24 volts AC/DC jumper selectable</li> </ul>  | <b>\$1,032</b> |

# Series 1400

## Power Supplies



2720 Clark Avenue  
St. Louis, MO 63103  
(314) 652-5588  
(314) 652-2090 FAX  
[www.acsi-inc.com](http://www.acsi-inc.com)

1-800-753-5558

# Series 1400 | Power Supplies

## 1406/1426 Power Supplies

ACSI 1406 and 1426 Power Supplies are designed to operate exit devices equipped with ACSI Series 1550 Electric Latch Retraction (required with 1550 Electric Solenoid Latch Retraction).

### Features

- UL Listed and tested to UL 294 standard
- Class 2 rated outputs
- 2A load capacity
- Overload, over voltage, and short circuit protection
- 1406 Series only: select from independent control of single exit devices from separate inputs (one or two single doors) or sequential operation of two exit devices from a single input (pair of doors)
- Automatic door operator interface
- Fire alarm interface
- Field adjustable latch retraction time delay
- 24VDC, 12VDC\* constant voltage outputs (250mA each)

\*Not available in battery backup models

### Day/Night Mode-ACSI 1426 Power Supply

Provides a separate input for retracting one exit device or two exit devices sequentially without activating the automatic door operator. While the latches are held retracted, the auto-operator can be activated independently from a different input.

### 1406BB/1426BB Power Supplies with Battery Backup

All the same features as above, but includes built-in battery backup power:

- 4 hours of backup power at full load during AC power failure
- Standby battery power with a supervised AC failure output and low battery output
- Supplied with (2) 12V, 7Ah lead acid batteries

## ACSI 1406 Application

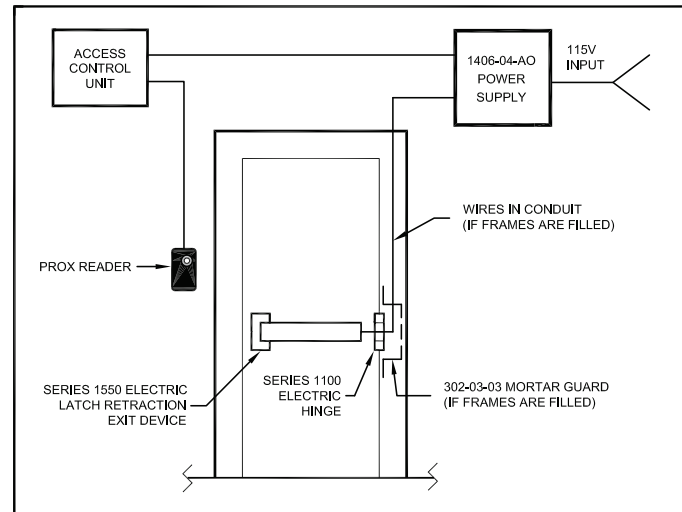

## ACSI 1426 Application

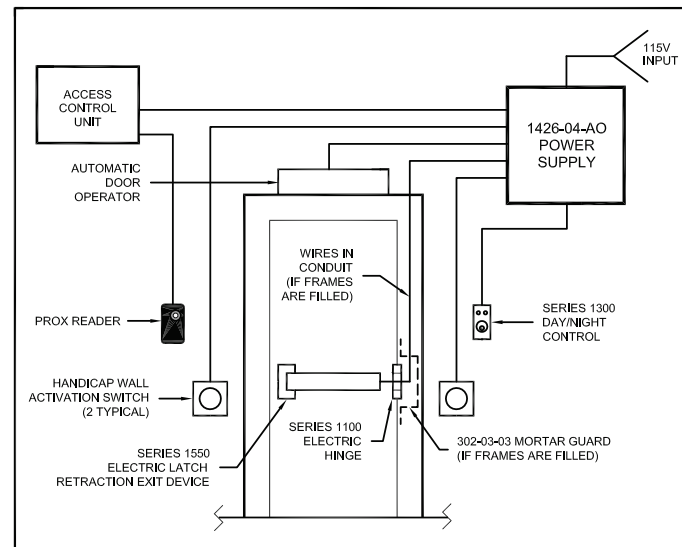

1406



1406BB

| Model  | Description                                    | List Price |
|--------|--|------------|
| 1406   | 1550 electric latch retraction                 | \$690      |
| 1426   | 1550 electric latch retraction, day/night mode | \$700      |
| 1406BB | 1406, battery backup                           | \$1,180    |
| 1426BB | 1426, battery backup                           | \$1,200    |

1-800-753-5558



# Series 1400 | Power Supplies

## 1410 Interlock Power Supply

ACSI 1410 Interlock Power Supply is designed to interconnect two or more doors using fail safe locking devices. Each supply can control up to four doors and the system can be expanded for requirements in excess of four doors. Any one door can be programmed to be a part of (common to) as many as three separate interlocking systems. Separate plug-in p.c. boards used to control interlocking doors can be programmed for normally locked or normally unlocked operation.

Inputs are available for fire alarm and optional emergency release interface for override of the interlocking system. Applications include darkrooms, laboratories, pharmaceuticals, detention centers, money counting rooms, airlocks, clean rooms, etc.

ACSI system engineers are available for design and consultation services to coordinate all aspects of the system. ACSI electric locking systems and all documentation including riser diagrams and point-to-point wiring diagrams can give distributors a single source for their system requirements.

### Features

- UL Listed and tested to UL 294 standard
- Filtered/Regulated 24VDC
- Class 2 rated outputs
- 2.2A load capacity
- Overload, over voltage, and short circuit protection
- Automatically accepts 120VAC or 240VAC input



1410-4

| Model  | Description      | List Price |
|--------|------------------|------------|
| 1410-2 | 2 Door Interlock | \$900      |
| 1410-3 | 3 Door Interlock | \$1,040    |
| 1410-4 | 4 Door Interlock | \$1,180    |

## ACSI Interlock System

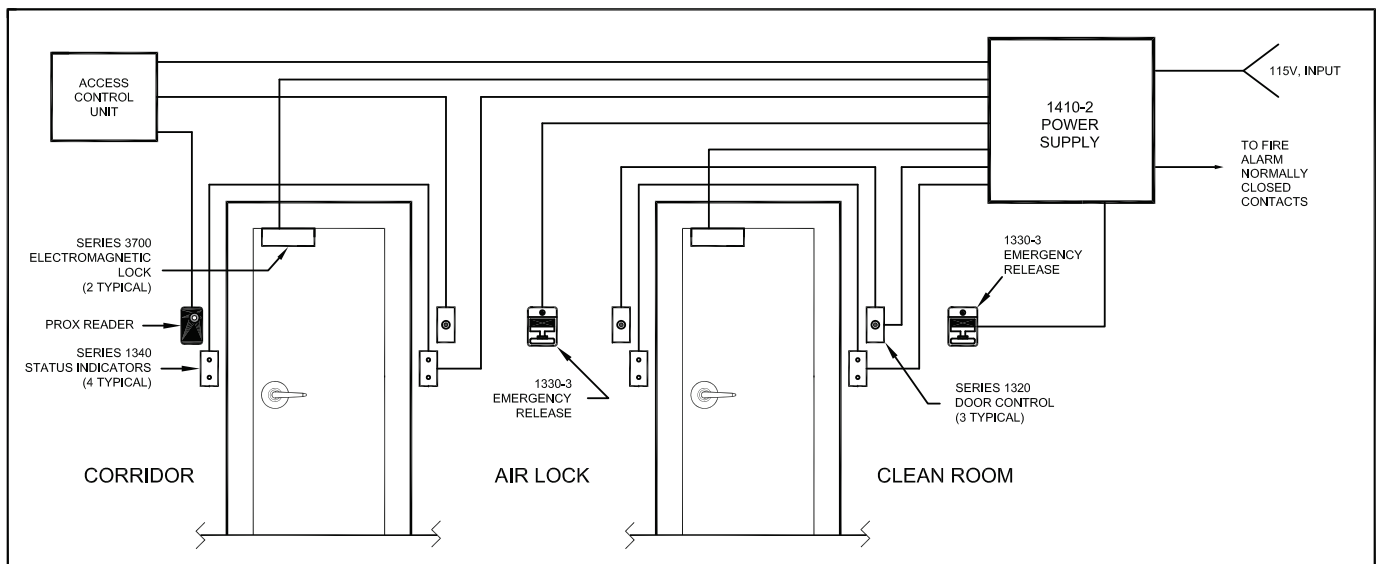

# Series 1400 | Power Supplies

## 1420 Power Supply

ACSI 1420 Power Supply can be used in the following applications:

- Provide power/control to exit devices equipped with the ACSI Series 1550-MD Motor Drive Electric Latch Retraction. (See ACSI Series 1500 Electric Exit Device Catalog)
- Provide power/control to electrified door hardware in applications requiring automatic door operator interface.

## Features

- UL Listed and tested to UL 294 standard
- Filtered/Regulated 24VDC
- Class 2 rated outputs
- 2A load capacity
- Overload, over voltage, and short circuit protection
- Automatically accepts 120VAC or 240VAC input

## Each 1420 Includes

- Separate inputs for activation switch on entry and exit sides of the opening.
- Relay dry contact output to automatic door operator input.
- Built-in 0.5 second time delay between activation of the electrified door hardware and automatic door operator.
- Input for optional fire alarm or emergency release switch when urgent unlocking of door is required.
- Auxiliary 24VDC constant voltage output
- Separate 24VDC outputs for fail safe and fail secure electrified door hardware.

## Options

DN – Day/Night mode provides a separate input for retracting one exit device or two exit devices simultaneously without activating the automatic door operator. While the latches are held retracted, the auto-operator can be activated independently from a different input.

## ACSI Automated Door Opening System

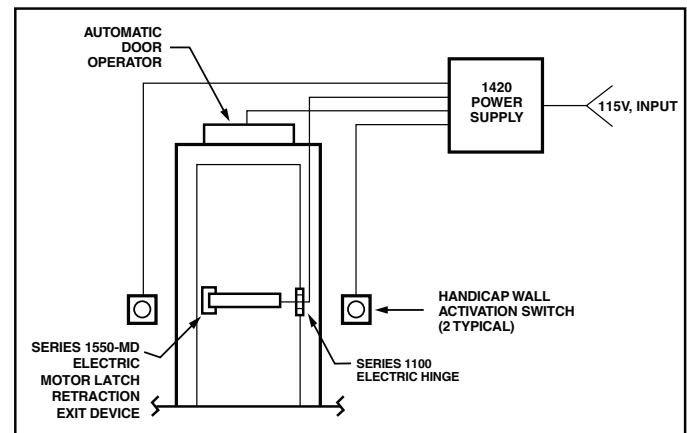

1420

| Model   | Description                            | List Price |
|---------|--|------------|
| 1420    | 24VDC, 2A automatic operator interface | \$460      |
| 1420-DN | 1420, day/night mode                   | \$520      |

# Series 1400 | Power Supplies

## 1440 Power Supply

ACSI 1440 Power Supply provides power for fail safe or fail secure locking devices.

### Features

- UL Listed and tested to UL 294 standard
- Filtered/Regulated 24VDC
- Class 2 rated outputs
- 2A load capacity
- Overload, over voltage, and short circuit protection
- Surge suppression on fail safe and fail secure outputs
- Automatically accepts 120VAC or 240VAC input

### Each 1440 Includes

- Interface relay to isolate the locking device current from the control switch
- Auxiliary 24VDC constant voltage for powering standalone devices such as keypads, motion detectors, status indicators, etc.
- Field terminal block set at 45° for ease of installation

### Options

TD – Adjustable time delay for 1 second to 60 minutes

| Model   | Description                 | List Price |
|---------|-----------------------------|------------|
| 1440    | 24VDC, 2A                   | \$420      |
| 1440-TD | 1440, adjustable time delay | \$510      |

### ACSI Locking System

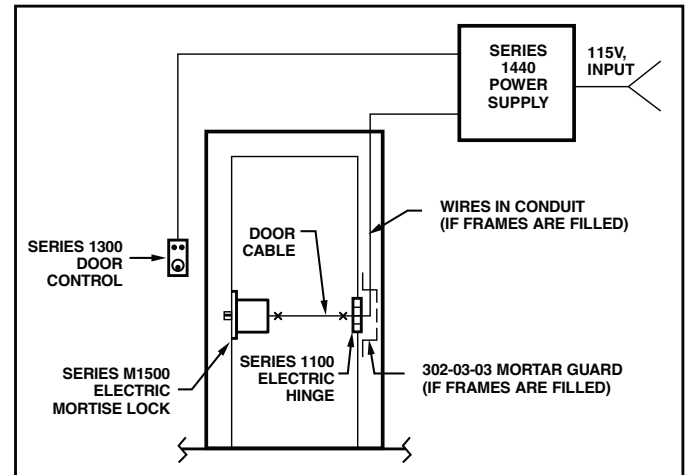

1440

# Series 1400 | Power Supplies

## 1451/1452 Power Supplies with Battery Backup

ACSI 1451 and 1452 Power Supplies can be used in the following applications:

- Provide power/control to exit devices equipped with the ACSI Series 1550-MD Motor Drive Electric Latch Retraction. (See ACSI Series 1500 Electric Exit Device Catalog)
- Provide power/control to electrified door hardware in applications requiring automatic door operator interface.
- Provide power for fail safe or fail secure locking devices.

### Features

- 1451-1A load capacity
- 1452-1.75A load capacity
- UL Listed for US and Canada
- Filtered/Regulated 12VDC or 24VDC
- Class 2 rated outputs
- Fire alarm interface
- Overload and short circuit protection
- Automatic switchover to standby battery when AC fails
- Built-in battery charger
- Supplied with (2) 12V, 7Ah lead acid batteries

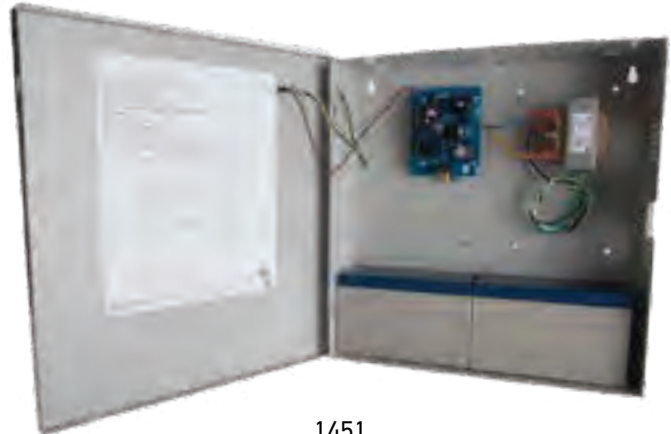

1451

### Options

- TD – Adjustable time delay for 1 second to 60 minutes
- DN – Day/Night mode provides a separate input for retracting one exit device or two exit devices simultaneously without activating the automatic door operator. While the latches are held retracted, the auto operator can be activated independently from a different input.
- AO – Automatic Operator Interface



1452

| Model   | Description                           | List Price |
|---------|---------------------------------------|------------|
| 1451    | 12VDC or 24VDC, 1A, battery backup    | \$700      |
| 1451-TD | 1451, adjustable time delay           | \$720      |
| 1451-DN | 1451, day/night mode                  | \$810      |
| 1451-AO | 1451, automatic operator interface    | \$780      |
| 1452    | 12VDC or 24VDC, 1.75A, battery backup | \$700      |
| 1452-TD | 1452, adjustable time delay           | \$730      |
| 1452-DN | 1452, day/night mode                  | \$820      |
| 1452-AO | 1452, automatic operator interface    | \$790      |

# Series 1400 | Power Supplies

## 1490 Delayed Egress Power Supply

ACSI 1490 Power Supply is designed to interface with ACSI electromagnetic locks in a delayed egress locking application.

### Features

- UL Listed
- Compliance with NFPA code requirements
- Filtered/Unregulated 24VDC
- 2A load capacity
- Input for delayed egress activation
- Manual reset of delayed egress alarm
- Optional auto reset available
- Fire alarm interface
- Output for audible alarm
- Field adjustable delay for nuisance alarm, door release, request-to-exit and auto reset delay times
- One power supply can provide up to 4 delayed egress alarm zones

### Description of System Operation

The delayed egress alarm becomes activated when the push bar of the Series 1500 modified exit device is depressed. A concealed AE (request-to-exit) switch initiates an irreversible cycle that begins with the Series 1300 audible alarm sounding for a predetermined time (field adjustable) while the Series 3700 electromagnetic lock remains energized locking the door.

At the end of the timing cycle, the electromagnetic lock de-energizes and unlocks the door while the audible alarm continues sounding. The door will remain unlocked and in an alarm state until manually reset by the Series 1300 keyswitch. Resetting the system will lock the door by energizing the electromagnetic lock and will turn off the audible alarm.

**Note:** When using the system with a door position switch, the door must be fully closed prior to resetting the system. Resetting with the door open will energize the electromagnetic lock, but will not turn off the audible alarm. The audible alarm will also begin sounding if a forced entry occurs while the system is armed.

In the event of a fire alarm, the electromagnetic lock will immediately de-energize to unlock the door. Upon resetting the fire alarm, the system will return to normal standby operation.

| Model   | Description  | List Price |
|---------|--------------|------------|
| 1490-21 | 1 zone card  | \$1,020    |
| 1490-22 | 2 zone cards | \$1,550    |
| 1490-23 | 3 zone cards | \$1,960    |
| 1490-24 | 4 zone cards | \$2,370    |

### ACSI 1490 Application

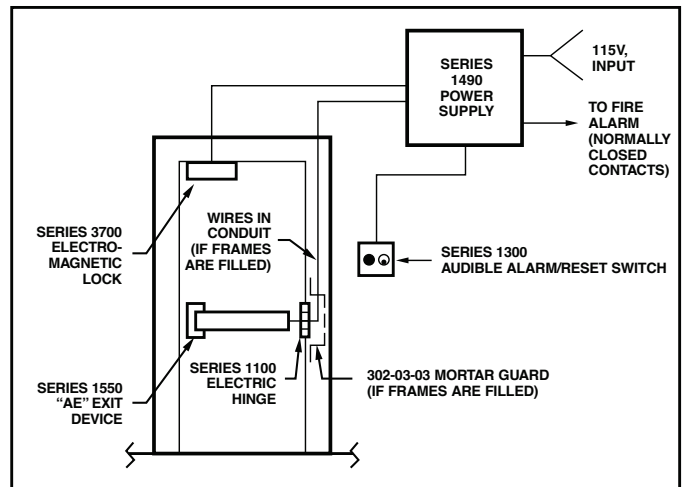

1490-21





# Series 1400 | Power Supplies

## Series 1400 Power Supply Specifications

ACSI Series 1400 Power Supplies are designed and manufactured by ACSI engineers to operate a variety of electric locking devices that will meet the most sophisticated specifications.

ACSI system engineers are available to assist you in the selection of the power supply that best meets your application. All ACSI designed systems include riser diagrams and point-to-point wiring diagrams that allow ease of interface with life-safety and security systems.

### Input

#### **1406, 1426, 1490**

120VAC, 0.75A, 60Hz

#### **1406BB, 1426BB**

120VAC, 1.08A, 60Hz

#### **1410, 1420, 1440, 1400-6100**

120VAC, 0.9A, 50/60Hz

240VAC, 0.6A, 50/60Hz

#### **1451**

115VAC, 0.6A, 50/60Hz

#### **1452**

115VAC, 0.6A, 50/60Hz

### Output

#### **1406, 1426**

1550 Device Outputs: 40VDC, 1.5A (combined) Filtered/Unregulated

Auxiliary 24V Output: 24VDC, 0.25A Filtered/Regulated

Auxiliary 12V Output: 12VDC, 0.25A Filtered/Regulated

#### **1406BB, 1426BB**

1550 Device Outputs: 40VDC, 1.8A (combined) Filtered/Unregulated

Auxiliary 24V Output: 24VDC, 0.2A Filtered/Regulated

#### **1490**

24VDC, 2A Filtered/Unregulated

#### **1420, 1440, 1400-6100**

24VDC, 2A Filtered/Regulated

#### **1410**

24VDC, 2.2A Filtered/Regulated

#### **1451**

12VDC or 24VDC, 1A Filtered/Regulated

#### **1452**

12VDC or 24VDC, 1.75A Filtered/Regulated

### Enclosure Dimensions/Type

#### **1406, 1410, 1420, 1426, 1440, 1400-6100**

10"x10"x4", NEMA Type 1 Screw Cover Junction Box

#### **1406BB, 1426BB**

12"x16"x4", NEMA Type 1 Screw Cover Junction Box

#### **1490**

12"x14"x4", Surface Mount Cabinet w/Hinged Door and Keyed Lock

#### **1451, 1452**

13.5"x13"x3.25", Surface Mount Cabinet w/Hinged Door and Cam Key Lock

### Enclosure Weight

#### **1410**

9 lbs (with all four plug-in boards installed onto motherboard)

#### **1406, 1426**

12 lbs

#### **1406BB, 1426BB**

26 lbs (with batteries)

#### **1420, 1440, 1400-6100**

8 lbs

#### **1490**

15 lbs (with all zone cards installed)

#### **1451, 1452**

18 lbs (with batteries)



# Series 1500

## Electric Exit Devices

---

Von Duprin

Corbin Russwin

Sargent

Yale

Dorma

Hager

Jackson

DormaKaba Commercial Hardware

BEST

Design Hardware

PDQ

First Choice

Falcon

Arrow

and more



# ACSI

2720 Clark Avenue  
St. Louis, MO 63103  
(314) 652-5588  
(314) 652-2090 FAX

[www.acsi-inc.com](http://www.acsi-inc.com)

1-800-753-5558

# Series 1500 | Electric Exit Devices

You supply the exit device and ACSI supplies high quality UL Listed modifications to a wide range of manufacturers' exit devices. ACSI engineers and technicians are available to provide system design, wiring diagrams, and a variety of technical services.

## 1550-MD Electric Motor Latch Retraction

ACSI Series 1550-MD Electric Motor Latch Retraction modification/kit provides a remote means of locking or unlocking exit devices.

- Simultaneous electric latch retraction and dogging (push bar depressed)
- UL Listed for both panic and fire exit hardware
- Available for mortise, rim, concealed and surface vertical rod exit devices
- Field or factory installed
- Quiet operation
- Continuous duty rated
- Low power consumption
- 24VDC operation
  - ACSI Series 1400 power supplies recommended
- Interface with life-safety systems
- Non-polarized leads
- On-board diagnostic LEDs
- Automatic retry



1550K-MDS



1550K-MDV



1550K-MDC



1550K-MDF



1550K-MDT



1550K-MDD



1550K-MDP



1550K-MDH



1550K-MDO

| Model       | Manufacturer's Series   | List Price |
|-------------|---|------------|
| 1550K-MDV   | Von Duprin 33A/35A, 98/99   | \$700      |
| 1550K-MDV22 | Von Duprin 22   | \$780      |
| 1550K-MDC   | Corbin Russwin ED4000, ED5000, Yale 7000                            | \$700      |
| 1550K-MDD   | Dorma 9000  | \$700      |
| 1550K-MDT   | Hager 4500, 4600<br>PDQ 6200<br>DormaKaba Commercial QED100, QED200 | \$780      |
| 1550K-MDO   | Falcon 1690, 1790<br>First Choice 3600, 3700                        | \$700      |
| 1550K-MDS   | Sargent 80<br>Arrow 1000, 3000, 4000                                | \$780      |
| 1550K-MDP   | Best Precision 2000, 5000   | \$780      |
| 1550K-MDF   | Falcon 24, 25   | \$780      |
| 1550K-MDH   | Design Hardware 1000<br>MARKSUSA M9900                              | \$780      |
| 1550K-MDY   | Yale 6000   | \$780      |
| 1550K-MDAEX | Adams Rite EX76, EX76W, EX88, EX88W                                 | \$780      |
| 1550K-MDX   | Dorex 9500  | \$780      |
| 1550K-MDA*  | Adams Rite 3000, 8000   | \$810      |
| 1550K-MDR*  | Regent 5700   | \$810      |
| 1550K-MDJ*  | Jackson 20  | \$810      |

\*Not available as a field installable kit. Factory installation required.

1-800-753-5558



## Series 1500 | Electric Exit Devices

### 1560/1570 Electric Trim Control

ACSI Series 1560/1570 Electric Trim Control modification provides a remote means of locking or unlocking outside lever handle trims of exit devices.

- Fail Safe (Power Lock)
  - Outside trim is locked when power is applied and unlocked when power is removed. Trim control will unlock in the event of a power failure.
- Fail Secure (Power Unlock)
  - Outside trim is unlocked when power is applied and locked when power is removed. Trim control will lock in the event of a power failure.
- Continuous duty rated
- Low power consumption
- 24VDC, 24VAC, 12VDC, or 12VAC operation
  - ACSI Series 1400 power supplies recommended
- Interface with life-safety systems



1570-996L-24VAC/DC

### 1510/1520 Electric Mortise Exit Control

ACSI Series 1510/1520 Electric Mortise Exit Control modification provides a remote means of locking or unlocking mortise exit devices.

- UL Listed
- Fail Safe (Power Lock)
  - Outside trim is locked when power is applied and unlocked when power is removed. Lockset will unlock in the event of a power failure.
- Fail Secure (Power Unlock)
  - Outside trim is unlocked when power is applied and locked when power is removed. Lockset will lock in the event of a power failure.
- Continuous duty rated
- Low power consumption
- 24VDC, 24VAC, 12VDC, or 12VAC operation
  - ACSI Series 1400 power supplies recommended
- Interface with life-safety systems



ME1520C-00-1-7500-24VAC/DC

# Series 1500 | Electric Exit Devices

## Electric Exit Device Modification Listing

**Note:** If you do not find the lock of your choice listed, please consult with our factory engineering staff. We may request that you send a sample for further evaluation.

| Arrow                       | Corbin Russwin  | Dorma    | Falcon     | BEST | Sargent | Von Duprin                    | Yale |
|-----------------------------|-----------------|----------|------------|------|---------|-------------------------------|------|
| 1000, 3000                  | ED4000          | 9000     | 24, 25     | 2000 | 80      | 33A/35A**                     | 7000 |
| 4000                        | ED5000          |          | 1690, 1790 | 5000 |         | 22, 98/99**                   | 6000 |
| Adams Rite                  | Design Hardware | Hager    | Jackson    | PDQ  | Regent  | DormaKaba Commercial Hardware |      |
| 3000                        | 1000            | 4500     | 20         | 6200 | 5700    | QED100, QED200                |      |
| EX76, EX76W,<br>EX88, EX88W |                 | 4600     |            |      |         |                               |      |
| Dorex                       | First Choice    | MARKSUSA |            |      |         |                               |      |
| 9500                        | 3600, 3700      | M9900    |            |      |         |                               |      |

\*\* Not available in Von Duprin 48 function.

# Series 1500 | Electric Exit Devices

## How to Order

| 1<br>EXIT DEVICE | 2<br>MODIFICATION # | 3<br>LOCK PART # | 4<br>OPERATING VOLTAGE | 5<br>OPTIONS | 6<br>QUICK CONNECT SYSTEM | 7<br>HANDING |
|------------------|---------------------|------------------|------------------------|--------------|---------------------------|--------------|
| RE               | 1550-MD             | FULL PART        | 24VDC                  | AE           | QC1                       | LHR          |
| VR               | 1560                | NUMBER           | 24VAC/DC               | LM           | QC2                       | RHR          |
| ME               | 1570                |                  | 12VDC                  |              | QC3                       |              |
|                  | 1510                |                  | 12VAC/DC               |              |                           |              |
|                  | 1520                |                  |                        |              |                           |              |

## Examples:

| 1<br>EXIT DEVICE | 2<br>MODIFICATION # | 3<br>LOCK PART #  | 4<br>OPERATING VOLTAGE | 5<br>OPTIONS | 6<br>QUICK CONNECT SYSTEM | 7<br>HANDING |
|------------------|---------------------|-------------------|------------------------|--------------|---------------------------|--------------|
| RE               | 1550-MD             | 8800 (SARGENT)    |                        | LM           | QC2                       | RHR          |
| ME               | 1520                | 9975 (VON DUPRIN) | 12VAC/DC               |              | QC3                       | LHR          |
| VR               | 1570                | 7120 (YALE)       | 24VDC                  | AE           | QC1                       | RHR          |

### 1. Exit Device

(Select type of lock to be modified)

LIST PRICE

|    |                          |            |
|----|--------------------------|------------|
| RE | Rim Exit Device          | <b>STD</b> |
| VR | Vertical Rod Exit Device | <b>STD</b> |
| ME | Mortise Exit Device      | <b>STD</b> |

### 4. Operating Voltage

Required for 1510/1520/1560/1570 modifications

LIST PRICE

|          |              |
|----------|--------------|
| 24VDC    | <b>STD</b>   |
| 24VAC/DC | <b>\$20</b>  |
| 12VAC/DC | <b>\$200</b> |

### 2. Modification Number

(Select type of lock modification required)

LIST PRICE

|         |                                  |              |
|---------|----------------------------------|--------------|
| 1550-MD | Motor Latch Retraction           | <b>\$800</b> |
| 1560    | Fail Safe Trim Control           | <b>\$340</b> |
| 1570    | Fail Secure Trim Control         | <b>\$340</b> |
| 1510    | Fail Safe Mortise Exit Control   | <b>\$340</b> |
| 1520    | Fail Secure Mortise Exit Control | <b>\$340</b> |

### 3. Lock Part Number

(Enter manufacturers full part number)

### 5. Options

LIST PRICE

|    |  |              |
|----|--|--------------|
| AE | <b>Authorized Egress</b><br>Monitors the use of the push bar. The AE Switch can be used to: <ul style="list-style-type: none"> <li>• Signal a control console when the push bar is depressed</li> <li>• Activate a door alarm</li> <li>• Control an electromagnetic lock for egress</li> <li>• Shunt a door alarm to allow egress</li> </ul> | <b>\$120</b> |
| LM | <b>Latch Bolt Monitor</b><br>Monitors the full extension of the latch bolt or rods.  | <b>\$120</b> |

### 6. Quick Connect System

(Select type of system to be modified)

LIST PRICE

|     |                           |                 |
|-----|---------------------------|-----------------|
| QC1 | ACSI Quick Connect System | <b>\$60</b>     |
| QC2 | ASSA ElectroLynx® System  | Consult Factory |
| QC3 | Allegion Connect System   | Consult Factory |

### 7. Handing

LIST PRICE

|     |                    |            |
|-----|--------------------|------------|
| RHR | Right Hand Reverse | <b>STD</b> |
| LHR | Left Hand Reverse  | <b>STD</b> |

1-800-753-5558

# Series 1500 | Electric Exit Devices

## Motor Electric Latch Retraction Comparison Chart

| Manufacturer   | Latch Retraction Part # | Power Supply Part #    | Latch Bolt Monitor Part # | Request-to-Exit |
|----------------|-------------------------|------------------------|---------------------------|-----------------|
| ACSI           | 1550-MD                 | 1420, 1440, 1451, 1452 | LM                        | AE              |
| Von Duprin     | QEL                     | 902                    | LX                        | RX              |
| Sargent        | 56                      | 3510                   | 53                        | 55              |
| Dorma          | MLR                     | PS532RF                | LM                        | MS              |
| Adams Rite     | SE                      | PS-SE                  | LM                        | M1              |
| Hager          | MLR                     | 2903, 2904             | LM                        | RX              |
| Corbin Russwin | MELR                    | BPS-24                 | M91                       | M92             |
| BEST           | MLR                     | RPSMLR2                | LS                        | TS              |

## Exit Device Switch Kits

ACSI Series K Switch Kits are field installed in exit devices. Series K Switch Kits include a SPDT (Single Pole Double Throw) switch assembly with long wire leads and easy-to-follow installation instructions. K Switch Kits may be used to:

- Provide instant release of magnetic locks for free egress
- Activate a door alarm
- Signal a control console when the push bar of an exit device is depressed
- Shunt a door alarm to allow free egress

| Model | Manufacturer   | List Price |
|-------|--|------------|
| K-100 | Von Duprin 22, 33A/35A, 98/99                                      | \$90       |
| K-200 | Von Duprin 22, 33A/35A, 98/99 (2-SPDT switches)                    | \$130      |
| K-123 | Latch Bolt Monitor for Von Duprin 33A/35A, 98/99                   | \$90       |
| K-102 | Von Duprin 88  | \$90       |
| K-103 | Sargent 80,<br>Arrow 1000, 3000, 4000<br>Dorex 9500                | \$90       |
| K-203 | Arrow 1000, 3000, 4000<br>Sargent 80 (1-DPDT switch)<br>Dorex 9500 | \$130      |
| K-104 | Sargent 9600, 9700, 9800, 9900                                     | \$90       |
| K-105 | Sargent 9300, 9400, 9500   | \$90       |
| K-106 | Adams Rite 3000, 8000  | \$90       |
| K-107 | Corbin Russwin 8000<br>Yale 2100                                   | \$90       |
| K-108 | Jackson 1085, 1095   | \$90       |
| K-109 | Corbin Russwin ED4000, ED5000<br>Yale 7000                         | \$90       |
| K-110 | Monarch 18, 19   | \$90       |
| K-111 | Doromatic 990, 1090  | \$90       |

| Model | Manufacturer   | List Price |
|-------|--|------------|
| K-112 | Doromatic 1490, 1590   | \$90       |
| K-124 | Best Precision 2000, 5000  | \$90       |
| K-125 | Dorma 9000   | \$90       |
| K-126 | Hager 4500, 4600<br>PDQ 6200<br>DormaKaba Commercial QED100, QED200                      | \$90       |
| K-226 | Hager 4500, 4600<br>PDQ 6200<br>DormaKaba Commercial QED100, QED200<br>(2 SPDT switches) | \$130      |
| K-128 | Design Hardware 1000<br>Mark USA M9900   | \$90       |
| K-129 | Falcon 24, 25  | \$90       |
| K-130 | Jackson 20   | \$90       |
| K-131 | Falcon 1690, 1790  | \$90       |
| K-132 | Adams Rite EX76, EX76W, EX88, EX88W  | \$90       |
| K-133 | Yale 6000  | \$90       |

# Series 1500 | Electric Exit Devices

## Electrical Specifications

### 1550-MD Motor Latch Retraction

- 24VDC, 1A Inrush, 400mA Holding

### 1510/1520

- 12VAC/DC, 612mA
- 24VAC/DC, 330mA

### 1560/1570

- 12VAC/DC, 612mA
- 24VAC/DC, 330mA

## Series 1550 Typical Installation

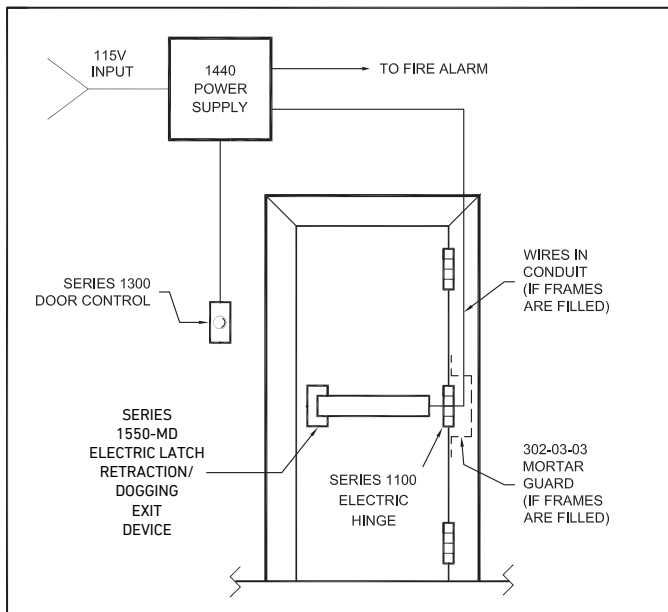

## ACSI Automated Door Opening System

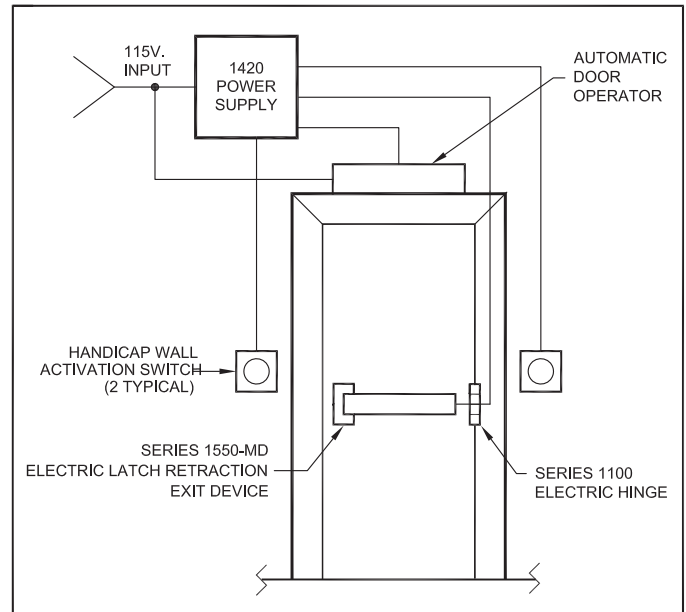



# Series 1500

## Electric Locks

---

Schlage  
Corbin Russwin  
Sargent  
Yale  
BEST  
Hager  
DormaKaba Commercial Hardware  
PDQ  
Falcon  
Arrow  
Design Hardware  
Tell  
Baldwin  
and more

# ACSI

2720 Clark Avenue  
St. Louis, MO 63103  
(314) 652-5588  
(314) 652-2090 FAX

[www.acsi-inc.com](http://www.acsi-inc.com)

1-800-753-5558



# Series 1500 | Electric Locks

ACSI supplies high quality UL Listed modifications to a wide range of manufacturers' locksets. Series 1500 electric locks provide safety and security for stairtower doors or controlled areas where both locking and latching are required. The Series 1500 locks allow remote electric locking or unlocking and/or motorized latch retraction while conforming to life-safety codes. Series 1500 locks are available in motor-controlled or solenoid-controlled in both mortise and cylindrical locks. Consult factory for solenoid-controlled locks.

## Features

- UL Listed
- California State Fire Marshall approved
- Fail Safe (Power Lock)
  - Outside trim is locked when power is applied and unlocked when power is removed (storeroom function when energized). Lockset will unlock in the event of a power failure (passage function).
- Fail Secure (Power Unlock)
  - Outside trim is unlocked when power is applied and locked when power is removed. Lockset will lock in the event of a power failure.
- 1500MLR-Motor Drive Latch Retraction
  - Outside trim (or both outside and inside trim depending on the lock function) is locked. The main latch bolt is retracted when power is applied. The main latch bolt is extended in the event of a power failure.
- Simple user selectable fail safe/fail secure operation in motor-controlled locks
- Continuous duty rated
- Low power consumption
- 24VDC, 24VAC, 12VDC or 12VAC operation
- When key cylinders are provided in the locks, the latch bolt may be momentarily retracted with key even though electrically locked. **Note:** Locks that are electrically unlocked may not be locked via the key cylinder.
- Wide variety of monitoring options are available
- Interface with life-safety systems

## Applications

Doors in stairtowers, offices, classrooms, interlocks, elevator lobbies, laboratories, computer rooms, cashier stations, hospital equipment rooms, pharmaceutical storage rooms

## Typical Installation

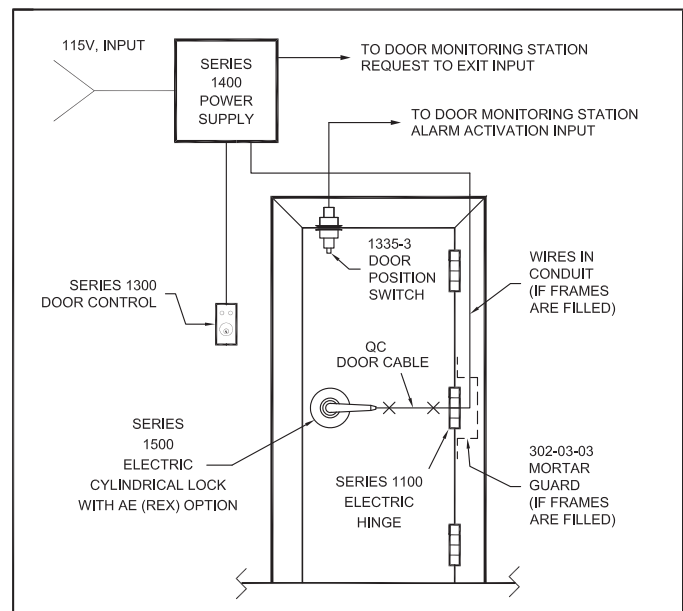
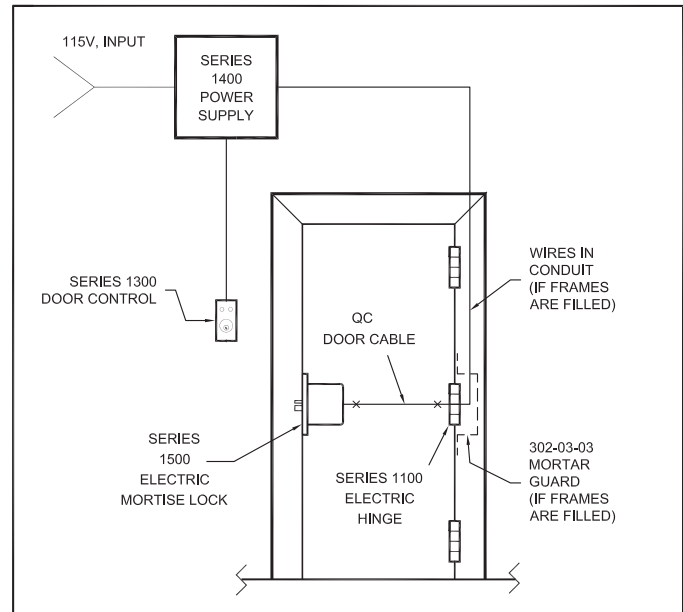

# Series 1500 | Electric Locks

## How to Order

| 1<br>LOCK TYPE | 2<br>MODIFICATION # | 3<br>OPTIONS | 4<br>LOCKING | 5<br>LOCK PART # | 6<br>OPERATING VOLTAGE | 7<br>QUICK CONNECT SYSTEM | 8<br>HANDING |
|----------------|---------------------|--------------|--------------|------------------|------------------------|---------------------------|--------------|
| M              | 1520M               | AE           | 1            | FULL             | 12/24V                 | QC1                       | RH           |
| C              | 1510M               | LM           | 2            | PART             | 24VDC                  | QC2                       | LH           |
| MU             | 1520                | SM           |              | NUMBER           | 24VAC/DC               | QC3                       | RHR          |
|                | 1510                | DM           |              |                  | 12VDC                  |                           | LHR          |
|                | 1500                | DMS          |              |                  | 12VAC/DC               |                           |              |
|                | 1500MLR             | DPS          |              |                  |                        |                           |              |
|                | 1520MLR             | LMR          |              |                  |                        |                           |              |
|                | 1510MLR             |              |              |                  |                        |                           |              |

## Example:

| LOCK TYPE | MODIFICATION # | OPTIONS | LOCKING | LOCK PART #     | OPERATING VOLTAGE | QUICK CONNECT CABLE | HANDING |
|-----------|----------------|---------|---------|-----------------|-------------------|---------------------|---------|
| M         | 1520M          | AE      | 1       | L9070 (SCHLAGE) | 12/24V            | QC3                 | RH      |

### 1. Lock Type

(Select type of lock to be modified)           LIST PRICE

|    |                  |               |
|----|------------------|---------------|
| M  | Mortise Lock     | <b>STD</b>    |
| C  | Cylindrical Lock | <b>+\$30</b>  |
| MU | Unit Lock        | <b>+\$300</b> |

### 2. Modification Number

(Select type of lock to be modified)           LIST PRICE

|          |   |                    |
|----------|---|--------------------|
| 1520M    | Fail Secure Motor-Controlled*                 | <b>\$300</b>       |
| 1510M    | Fail Safe Motor-Controlled*                   | <b>\$300</b>       |
| 1520     | Fail Secure Solenoid-Controlled               | <b>\$300</b>       |
| 1510     | Fail Safe Solenoid-Controlled                 | <b>\$300</b>       |
| 1500MLR  | Latch Retraction                              | <b>\$1,300</b>     |
| M1520MLR | Latch Retraction/Fail Secure Motor-Controlled | <b>\$1,600</b>     |
| M1510MLR | Latch Retraction/Fail Safe Motor-Controlled   | <b>\$1,600</b>     |
| 1500     | Monitor Only                                  | <b>See Options</b> |

**NOTE:** \*Factory ships Fail Secure as default (unless specified Fail Safe).  
Field selectable to Fail Safe.

1-800-753-5558

# Series 1500 | Electric Locks

## How to Order (Cont.)

| 3. Options <input type="checkbox"/> <input type="checkbox"/> <input type="checkbox"/> <input type="checkbox"/> <input type="checkbox"/> <input type="checkbox"/> |   | LIST PRICE   |
|--|---|--------------|
| AE   | <b>Authorized Egress (Mortise or Cylindrical Lock)</b><br>Monitors the use of the INSIDE trim when the OUTSIDE trim is locked.<br>The AE switch can be used to:<br>• Shunt a door alarm to allow egress<br>• Signal a control console when the trim is activated<br>• Activate a door alarm<br>• Control an electromagnetic lock for egress | <b>\$150</b> |
| LM   | <b>Latch Bolt Monitor (Mortise Lock)</b><br>Monitors the full extension of the main latch.  | <b>\$150</b> |
| SM   | <b>Security Monitoring (Mortise Lock)</b><br>Monitors the locked or unlocked status and the dead latch status in series.  | <b>\$280</b> |
| DM   | <b>Deadbolt Monitor (Mortise Lock)</b><br>Monitors the full extension of the deadbolt.  | <b>\$260</b> |
| DMS  | <b>Deadbolt Monitor Secured (Mortise Lock)</b><br>Monitors the full extension of the deadbolt disabling the electrical control of a fail secure lockset locking the OUTSIDE trim. Retracting the deadbolt enables the electrical control. Free egress at all times.<br>• Uses include private rooms, restrooms, and lactation rooms.        | <b>\$380</b> |
| DPS  | <b>Door Position Sensor (Mortise Lock)</b><br>Monitors the door position. A magnetic sensor mounted in the mortise lock reacts to the proximity of a magnet mounted behind the ASA strike.  | <b>\$200</b> |
| AM   | <b>Auxiliary Latch Monitor (Mortise Lock)</b><br>Monitors the position of the dead latch.   | <b>\$150</b> |
| LB   | <b>Locking Bar Monitor (Mortise Lock)</b><br>Monitors the position of the locking bar.  | <b>\$150</b> |
| KM   | <b>Key Cylinder Monitor (Mortise Lock)</b><br>Monitors the use of a key for retracting the latch.   | <b>\$150</b> |
| LMR  | <b>Latch Bolt Monitor Retracted (Mortise Lock with MLR)</b><br>Monitors the full retraction of the main latch. A dry contact closure will occur 0.5 seconds after the full retraction of the main latch bolt under power and will remain until power is removed or if the main latch bolt unintentionally extends.                          | <b>\$180</b> |
| MK-10  | <b>Authorized Egress Kit</b><br>Field installable for Schlage L series mortise lock.  | <b>\$90</b>  |

| 4. Locking <input type="checkbox"/> <input type="checkbox"/> <input type="checkbox"/> <input type="checkbox"/> <input type="checkbox"/> <input type="checkbox"/> |  | LIST PRICE  |
|--|--|-------------|
| 1  | Standard control locks outside (secure side) trim. | <b>STD</b>  |
| 2  | Locks both sides – mortise locks only.             | <b>\$40</b> |

| 5. Lock Part No. <input type="checkbox"/> <input type="checkbox"/> <input type="checkbox"/> <input type="checkbox"/> <input type="checkbox"/> <input type="checkbox"/>   |  |
|--|--|
| Distributors supply ACSI with mortise, cylindrical or unit locks for modification. Please supply the lock manufacturer's full part number.<br><b>Example:</b> L9070, 8237, 8808, ND80, 3357, etc.<br><i>Note: Refer to the last page of this catalog section for a complete listing of locks required by ACSI.</i> |  |

| 6. Operating Voltage <input type="checkbox"/> <input type="checkbox"/> <input type="checkbox"/> <input type="checkbox"/> <input type="checkbox"/> <input type="checkbox"/> |  | LIST PRICE   |
|--|--|--------------|
| 12/24V   | Motor-Controlled Locks, automatic 12V or 24V, AC or DC operating voltage | <b>STD</b>   |
| 24VDC  | Solenoid-Controlled Locks  | <b>\$100</b> |
| 24VAC/DC   | Solenoid-Controlled Locks  | <b>\$100</b> |
| 12VDC  | Solenoid-Controlled Locks  | <b>\$200</b> |
| 12VAC/DC   | Solenoid-Controlled Locks  | <b>\$200</b> |

*Note: For Solenoid-Controlled locks consult factory.*

| 7. Quick Connect System <input type="checkbox"/> <input type="checkbox"/> <input type="checkbox"/> <input type="checkbox"/> <input type="checkbox"/> <input type="checkbox"/> |                           |                        |
|---|---------------------------|------------------------|
| QC1   | ACSI Quick Connect System | <b>\$60</b>            |
| QC2   | ASSA Connect System       | <b>Consult Factory</b> |
| QC3   | Allegion Connect System   | <b>Consult Factory</b> |

| 8. Handing <input type="checkbox"/> <input type="checkbox"/> <input type="checkbox"/> <input type="checkbox"/> <input type="checkbox"/> <input type="checkbox"/> |                    | LIST PRICE |
|--|--------------------|------------|
| RH   | Right Hand         | <b>STD</b> |
| LH   | Left Hand          | <b>STD</b> |
| RHR  | Right Hand Reverse | <b>STD</b> |
| LHR  | Left Hand Reverse  | <b>STD</b> |

# Series 1500 | Electric Locks

## Electric Mortise Lock Bodies

ACSI Stocks Electric Mortise Lock Bodies available in Schlage, Corbin Russwin, Sargent, Yale, BEST and Falcon are available as motor-controlled. Motor-controlled locks are field selectable for fail safe or fail secure and have automatic 12V or 24V, AC or DC operation. ACSI 1500MLR motorized latch retraction is available in Schlage L9070B and also available in 1520MLR, 1510MLR for dual latch retraction and lock/unlock features. A variety of monitoring options are available. Consult factory for solenoid-controlled locks.

| Motor-Controlled |        |               |  | LIST PRICE      |
|------------------|--------|---------------|--|-----------------|
| M1510M           | L9070B | 12/24V        | Schlage Fail Safe                        | <b>\$920</b>    |
| M1510M           | L9453B | 12/24V        | Schlage Deadbolt Fail Safe               | <b>\$1,200</b>  |
| M1510M           | 2055B  | 12/24V        | Corbin Russwin Fail Safe                 | Consult Factory |
| M1510M           | 8237B  | 12/24V        | Sargent Fail Safe                        | Consult Factory |
| M1510M           | 8808B  | 12/24V        | Yale Fail Safe                           | Consult Factory |
| M1510M           | MA561B | 12/24V        | Falcon Fail Safe                         | Consult Factory |
| M1520M           | L9070B | 12/24V        | Schlage Fail Secure                      | <b>\$920</b>    |
| M1520M           | L9453B | 12/24V        | Schlage Deadbolt Fail Secure             | <b>\$1,200</b>  |
| M1520M           | 2055B  | 12/24V        | Corbin Russwin Fail Secure               | Consult Factory |
| M1520M           | 8237B  | 12/24V        | Sargent Fail Secure                      | Consult Factory |
| M1520M           | 8808B  | 12/24V        | Yale Fail Secure                         | Consult Factory |
| M1520M           | MA561B | 12/24V        | Falcon Fail Secure                       | Consult Factory |
| M1500MLR         | L9070B | 24VDC         | Schlage Latch Retraction                 | <b>\$1,850</b>  |
| M1510MLR         | L9070B | 24VDC, 12/24V | Schlage Latch Retraction/<br>Fail Safe   | <b>\$2,150</b>  |
| M1520MLR         | L9070B | 24VDC, 12/24V | Schlage Latch Retraction/<br>Fail Secure | <b>\$2,150</b>  |

| Solenoid-Controlled |        |          |                            | LIST PRICE      |
|---------------------|--------|----------|----------------------------|-----------------|
| M1510               | L9070B | 24VAC/DC | Schlage Fail Safe          | Consult Factory |
| M1510               | 2055B  | 24VAC/DC | Corbin Russwin Fail Safe   | Consult Factory |
| M1510               | 8237B  | 24VAC/DC | Sargent Fail Safe          | Consult Factory |
| M1510               | 8808B  | 24VAC/DC | Yale Fail Safe             | Consult Factory |
| M1510               | 45H7RB | 24VAC/DC | Best Fail Safe             | Consult Factory |
| M1510               | MA561B | 24VAC/DC | Falcon Fail Safe           | Consult Factory |
| M1520               | L9070B | 24VAC/DC | Schlage Fail Secure        | Consult Factory |
| M1520               | 2055B  | 24VAC/DC | Corbin Russwin Fail Secure | Consult Factory |
| M1520               | 8237B  | 24VAC/DC | Sargent Fail Secure        | Consult Factory |
| M1520               | 8808B  | 24VAC/DC | Yale Fail Secure           | Consult Factory |
| M1520               | 45H7RB | 24VAC/DC | Best Fail Secure           | Consult Factory |
| M1520               | MA561B | 24VAC/DC | Falcon Fail Secure         | Consult Factory |



## Electrical Specifications

### M1510M / M1520M

- 12/24V, 250mA Inrush, 10mA Holding

### M1510 / M1520

- 12VAC/DC, 612mA
- 24VAC/DC, 330mA

### MU1510 / MU1520

- 12VAC/DC, 612mA
- 24VAC/DC, 330mA

### M1500MLR

- 24VDC, 625mA Inrush, 150mA Holding

1-800-753-5558

# Series 1500 | Electric Locks

## Electric Cylindrical Locks

ACSI Stocks Electric Cylindrical Locks available in Schlage, Corbin Russwin, Sargent and Yale. The locks are available as motor-controlled. Motor-controlled locks are field selectable for fail safe or fail secure and have automatic 12V or 24V, AC or DC operation. Authorized Egress (Request-to-Exit) option is also available. Consult factory for solenoid-controlled locks.

| Motor-Controlled |         |        |     |     |                            | LIST PRICE      |
|------------------|---------|--------|-----|-----|----------------------------|-----------------|
| C1510M*          | ND70B   | 12/24V |     |     | Schlage Fail Safe          | <b>\$900</b>    |
| C1510M           | 10G04B  | 12/24V | LL  | 626 | Sargent Fail Safe          | Consult Factory |
| C1510M           | 3357B   | 12/24V | NZD | 626 | Corbin Russwin Fail Safe   | Consult Factory |
| C1510M           | 5405LNB | 12/24V | AU  | 626 | Yale Fail Safe             | Consult Factory |
| C1520M*          | ND70B   | 12/24V |     |     | Schlage Fail Secure        | <b>\$900</b>    |
| C1520M           | 10G04B  | 12/24V | LL  | 626 | Sargent Fail Secure        | Consult Factory |
| C1520M           | 3357B   | 12/24V | NZD | 626 | Corbin Russwin Fail Secure | Consult Factory |
| C1520M           | 5405LNB | 12/24V | AU  | 626 | Yale Fail Secure           | Consult Factory |

\* Specify trim style, format and finish. Available in Rhodes, Sparta and Athens trim style.  
 Finishes available in 626, 625 and 613. Add \$60 list for 613 finish. Add \$60 list for HD, RD, TD.

## Electrical Specifications

### C1510M / C1520M

- 12/24V, 250mA Inrush, 10mA Holding



Sargent C1520M



Schlage C1520



Yale C1520M



Corbin C1520M

1-800-753-5558

# Series 1500 | Electric Locks

## Electric Lock Comparison Chart

| ACSI              | ARROW            | BEST | CORBIN RUSSWIN      | DESIGN HARDWARE | FALCON |
|-------------------|------------------|------|---------------------|-----------------|--------|
| M1510M/M1520M-1** |                  |      | 20906, 20907        | E-M-07-FS/FSE   |        |
| M1510M/M1520M-2** |                  |      | 20914, 20915, 20932 | E-M-30-FS/FSE   |        |
| M1510-1           | A17-177, B17-177 | EWEL | 20903, 20910        | E-M-07-FS       | M851   |
| M1510-2           |                  | WWEL | 20901, 20920        | E-M-30-FS       | M811   |
| M1520-1           | A17-178, B17-178 | EWEU | 20905, 20930        | E-M-07-FSE      | M881   |
| M1520-2           |                  | WWEU | 20940               | E-M-30-FSE      | M821   |
| C1510M/C1520M-1** |                  |      |                     | E-Z-86-FS/FSE   |        |
| C1510-1           | Q12-177, H12-177 | DEL  | 33903               | E-Z-86-FS       | T851   |
| C1520-1           | Q12-178, H12-178 | DEU  | 33905               | E-Z-86-FSE      | T881   |
| AE                | RE               | RQE  | M92                 | REX             | RX*    |
| LM*               | LM*              | LS*  | M91*                | LM*             |        |
| SM*               | SM*              |      | M105*               | SM*             |        |
| DM*               |                  |      |                     |                 |        |
| DMS*              |                  |      |                     |                 |        |
| DPS*              |                  | DS*  |                     |                 |        |

\*\*Motor-controlled

\*Available in Mortise only

| ACSI              | HAGER     | PDQ      | SARGENT    | SCHLAGE                                | DormaKaba<br>Commercial Hardware | YALE   |
|-------------------|-----------|----------|------------|--|----------------------------------|--------|
| M1510M/M1520M-1** | 3880EL/EU | MR199A** | 8270, 8271 | L9090EL/EU<br>L9092EL/EU<br>L9094EL/EU |                                  |        |
| M1510M/M1520M-2** |           | MR200    | 8272, 8273 | L9091EL/EU<br>L9093EL/EU<br>L9095EL/EU |                                  |        |
| M1510-1           | 3880EL    |          | 8270       | L9080EL                                |                                  | 8890   |
| M1510-2           |           |          | 8272       | L9082EL                                |                                  | 9984-2 |
| M1520-1           | 3880EU    |          | 8271       | L9080EU                                |                                  | 8891   |
| M1520-2           |           |          | 8273       | L9082EU                                |                                  | 8895-2 |
| C1510M/C1520M-1** | 3480EL/EU |          |            | ND80EL/EU                              |                                  |        |
| C1510-1           | 3480EL    | GT199FS  | 10G70      | ND80EL                                 | QCL192                           | 5490   |
| C1520-1           | 3480EU    | GT199FSC | 10G71      | ND80EU                                 | QCL194                           | 5491   |
| AE                | RX        | REX      | RX         | RX                                     | X                                | REX    |
| LM*               | LM*       | LM*      | LX*        | LX*                                    |                                  | LBM*   |
| SM*               |           |          |            |  |                                  |        |
| DM*               |           |          | DX*        |  |                                  |        |
| DMS*              |           |          | DX*        |  |                                  |        |
| DPS*              | DPM*      |          |            |  |                                  |        |

\*\*Motor-controlled

\*Available in Mortise only

1-800-753-5558

# Series 1500 | Electric Locks

## Electric Lock Modification Listing

Note: If you do not find the lock of your choice listed, please consult with our factory engineering staff. We may request that you send a sample for further evaluation.

| Manufacturer       | Mortise Locks                                   | Cylindrical Locks  | Unit Locks |
|--------------------|---|--------------------|------------|
| Arrow              | AM17, BM17                                      | QL82               |            |
| Baldwin            | 6065*, 6065LS*                                  |                    |            |
| Best               | 45H7R*  |                    |            |
| Corbin Russwin     | 2055  | 3357               | UT15257    |
| Design Hardware    | M-05, M-13                                      | Z-84               |            |
| Falcon             | MA561, MA571                                    | T561               |            |
| Hager              | 3850, 3856                                      | 3480               |            |
| PDQ                | MR148*  |                    |            |
| Sargent            | 8237, 8225                                      | 10G04              |            |
| Schlage            | L9050, L9070<br>L9080** (see note below), L9453 | ND70, ND80<br>ND94 |            |
| DormaKaba          | QM160*  | QCL170             |            |
| Tell Manufacturing |   | LC2486             |            |
| Yale               | 8800, 8847                                      | 5405LN             |            |

\*Available in solenoid-controlled only

\*\*Schlage L9080 must be supplied with extra spring cage to compensate for lever sag of outside trim.

## Lock Schematics

AE – Authorized Egress

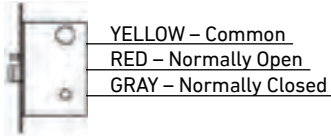

LM – Latch Bolt Monitor

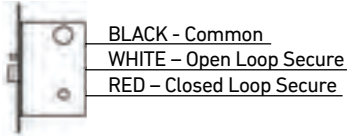

SM – Security Monitoring

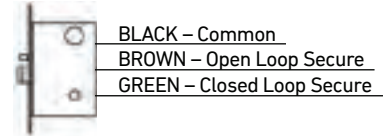

DM – Deadbolt Monitor

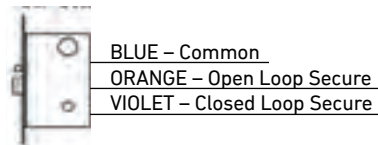

DPS – Door Position Sensor

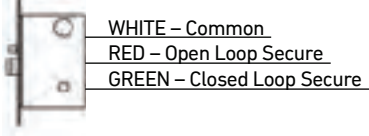

M1510 / M1520 / M1510M / M1520M

DMS – Deadbolt Monitor Secured

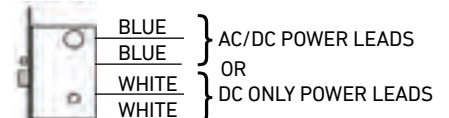

Red ty-wrap on leads designates 12V only.

AE – Authorized Egress

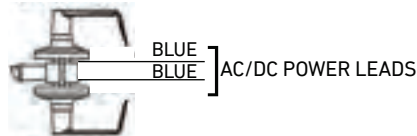
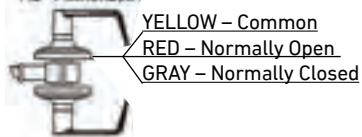

1500MLR

LMR - latch bolt monitor retracted

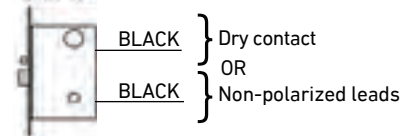

AM – Auxiliary Latch Monitor

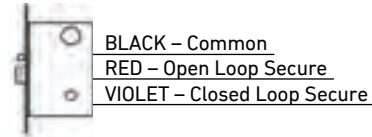

LB – Locking Bar Monitor

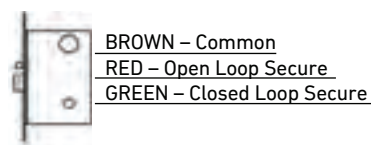

KM – Key Retraction Monitor

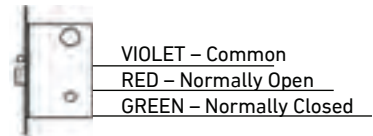



# Series 3700

## Electromagnetic Locks

---

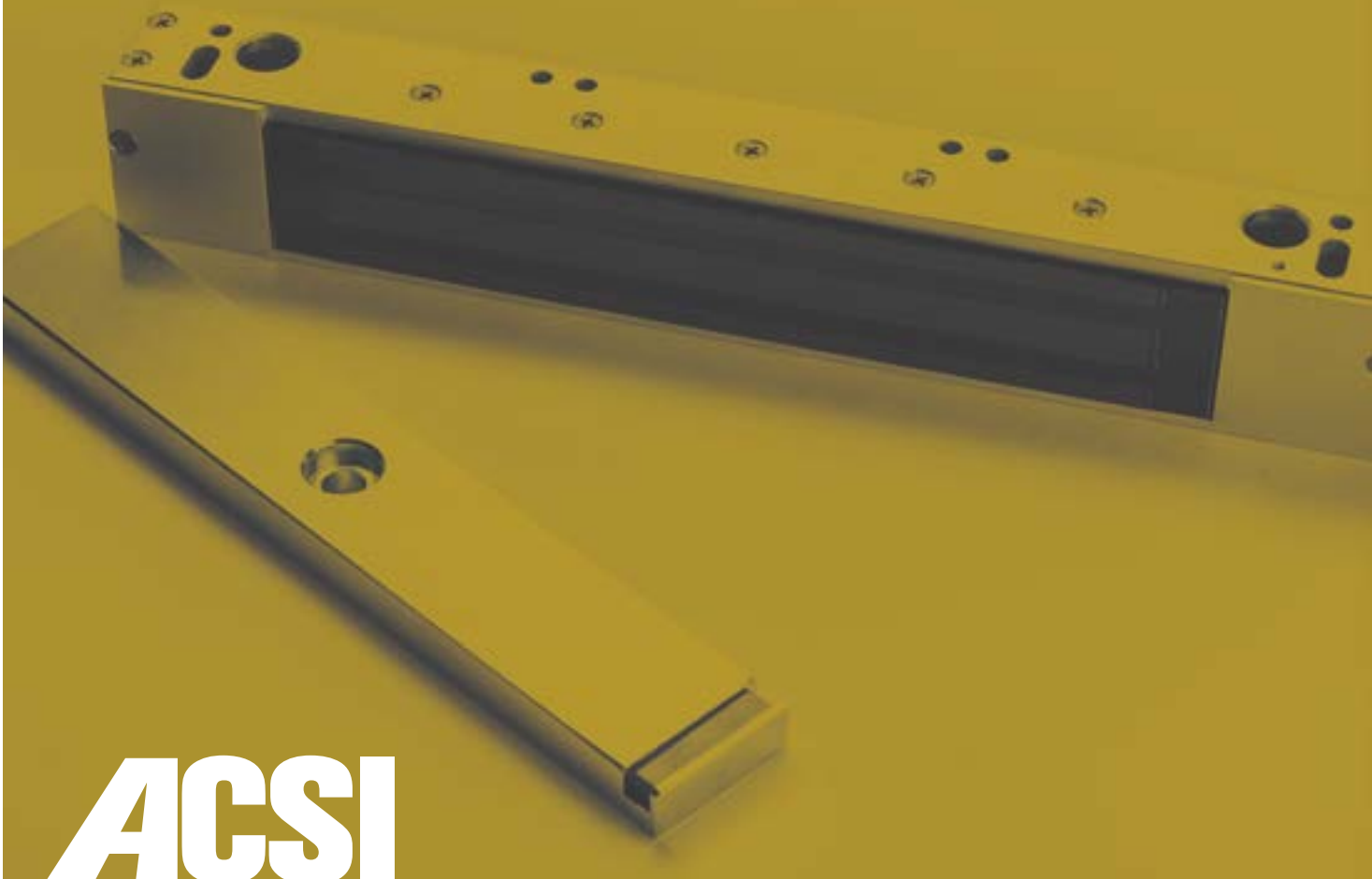

# ACSI

2720 Clark Avenue  
St. Louis, MO 63103  
(314) 652-5588  
(314) 652-2090 FAX

[www.acsi-inc.com](http://www.acsi-inc.com)

1-800-753-5558

# Series 3700 | Electromagnetic Locks

ACSI Series 3700 UL Listed Electromagnetic Locks combine high security features with fail safe operation and conform with life-safety codes. The Series 3700 is designed for single or pairs of outswing or inswing doors.

## Features

- UL Listed
- Variety of models available
- Positive fail safe security
- No moving parts - maintenance free
- Low power consumption
- Built-in surge and spike protection
- Built-in door position sensor

## Options

- Magnetic bond sensor
- Power LED
- Custom length housings
- Variety of architectural finishes
- Glass door brackets

## Typical Installation

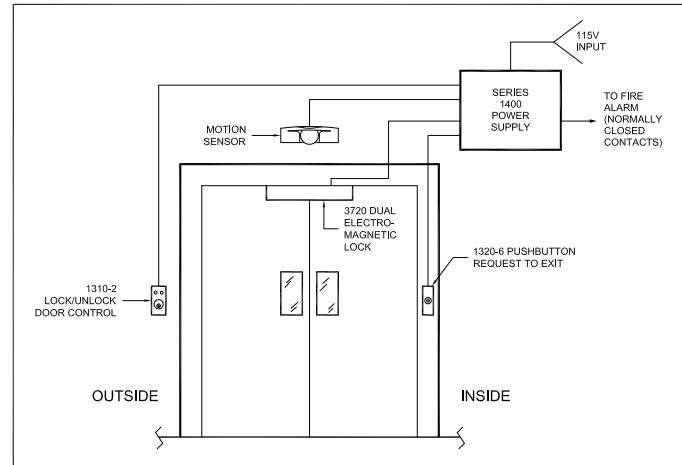

## Electrical Specifications

- 12VDC, 500mA
- 24VDC, 250mA

## How to Order

| 1. Model <span style="float:right">List Price</span> |   |
|--|---|
| 3710   | Single 1200 lb. magnetic lock (outswing) <b>\$540</b>                 |
| 3711   | Single 1200 lb. magnetic lock with Z bracket (inswing) <b>\$690</b>   |
| 3720   | Double 1200 lb. magnetic lock (outswing) <b>\$1,070</b>               |
| 3721   | Double 1200 lb. magnetic lock with Z bracket (inswing) <b>\$1,350</b> |
| 3750   | Single 1200 lb. magnetic lock for sliding doors <b>\$720</b>          |
| 3760   | Single 300 lb. magnetic lock <b>\$460</b>                             |
| 3770   | Double 300 lb. magnetic lock <b>\$930</b>                             |
| 3780   | Single 600 lb. magnetic lock <b>\$500</b>                             |
| 3790   | Double 600 lb. magnetic lock <b>\$1,010</b>                           |

| 2. Operating Voltage <span style="float:right">List Price</span> |             |
|--|-------------|
| 24VDC  | <b>STD</b>  |
| 12VDC  | <b>\$40</b> |

| 3. Finish <span style="float:right">List Price</span> |                                |
|---|--------------------------------|
| SA  | Satin Aluminum <b>STD</b>      |
| BA  | Black Anodized <b>POA</b>      |
| GA  | Gold Anodized <b>POA</b>       |
| DBN   | Dark Brown Anodized <b>POA</b> |
| US3   | Bright Brass <b>POA</b>        |
| US4   | Satin Brass <b>POA</b>         |
| US26  | Bright Chrome <b>POA</b>       |

| 4. Options <span style="float:right">List Price</span> |  |
|--|--|
| MBS  | Magnetic bond sensor <b>\$140</b>                                |
| L1   | 1 LED (green or red) <b>\$36</b>                                 |
| L2   | 2 LEDs (green and red) <b>\$70</b>                               |
| FP1  | Filler plate, single magnet* <b>\$86</b>                         |
| FP2  | Filler plate, double magnet* <b>\$100</b>                        |
| GLB-1  | 1/2" glass door bracket <b>\$140</b>                             |
| GLB-2  | 3/4" glass door bracket <b>\$140</b>                             |
| AB-1   | Angle bracket for single magnet (1"x1"x14") <b>\$140</b>         |
| AB-2   | Angle bracket for double magnet (1"x1"x25") <b>\$180</b>         |
| AB-3   | Angle bracket for single magnet (1-1/2"x2-5/8"x14") <b>\$140</b> |
| AB-4   | Angle bracket for double magnet (1-1/2"x2-5/8"x25") <b>\$190</b> |

\* Specify 1/2" or 5/8" thick.

Note: Please consult the factory for custom length decorative housings.

1-800-753-5558



# Series 6100

## Communicating Bath Door System

---

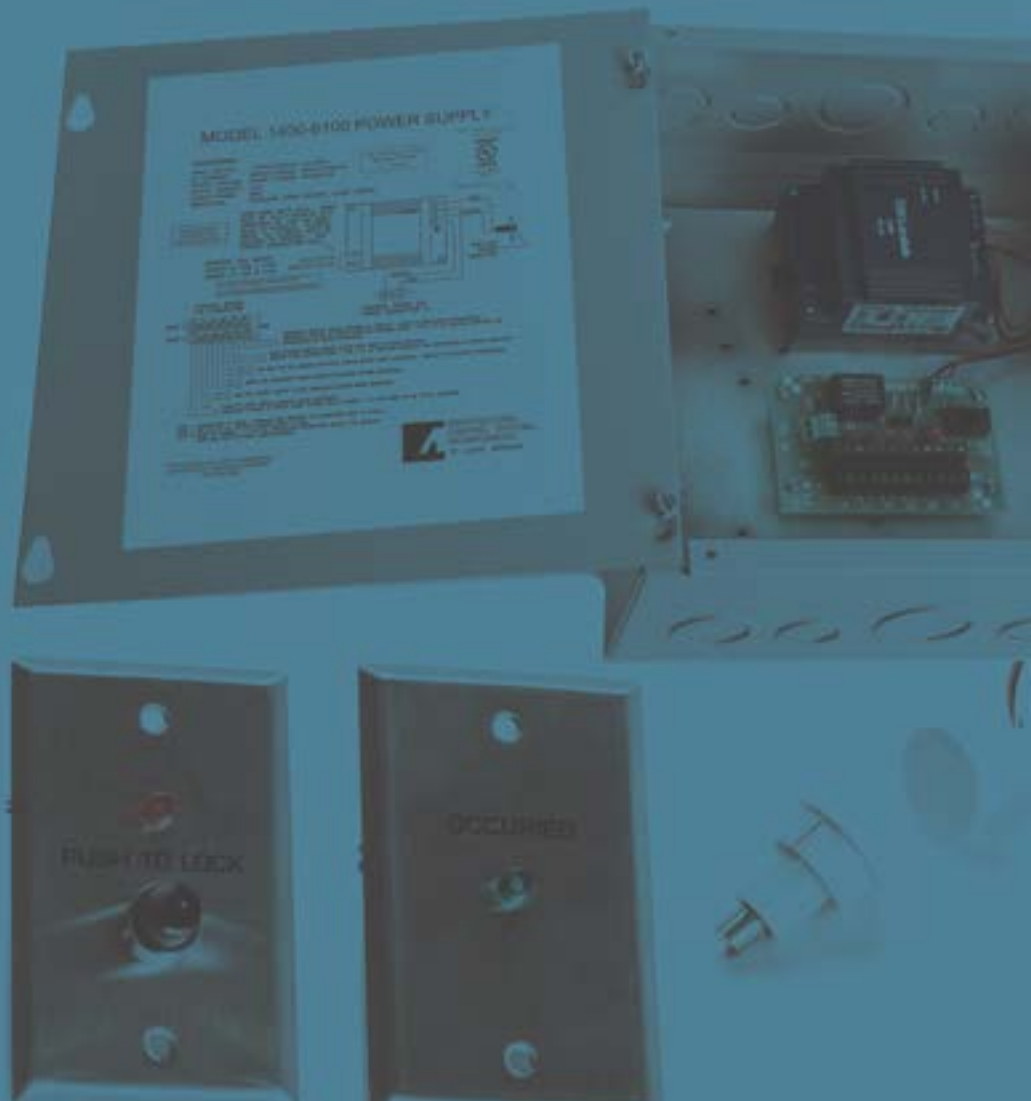

# ACSI

2720 Clark Avenue  
St. Louis, MO 63103  
(314) 652-5588  
(314) 652-2090 FAX

[www.acsi-inc.com](http://www.acsi-inc.com)

1-800-753-5558

# Series 6100 | Communicating Bath Door System

ACSI Series 6100 Communicating Bath Door System is designed to coordinate access to a common bathroom facility from adjoining rooms. This system allows more efficient utilization of floor space in facilities by eliminating the need for a bathroom in each room.

## Features

- Fail safe system - doors will unlock when power is removed
- Free egress at all times
- User privacy
- Eliminates accidental lock-out from either room to the bathroom
- Mechanical key override allows personnel to enter during an emergency
- 2A load capacity
- Inputs available for optional emergency release switch when urgent unlocking of the door is required
- Convenient field wiring of system components

## Options

- Located above outside doors for emergency release:

| Model        | Description                                  | List Price   |
|--------------|--|--------------|
| 1330-3       | Emergency Release                            | <b>\$288</b> |
| 1320-1MOM-ER | Pushbutton Switch marked "Emergency Release" | <b>\$140</b> |



| Model | Description                    | List Price   |
|-------|--------------------------------|--------------|
| 6100  | Communication Bath Door System | <b>\$960</b> |

## Included Components

| Qty    | Description                                      |
|--------|--|
| 1 Each | 1400-6100 Power Supply                           |
| 2 Each | Door Position Sensors                            |
| 2 Each | Pushbuttons with indicator marked "Push to Lock" |
| 2 Each | Indicators marked "Occupied"                     |

## Required Components

| Qty    | Description                     |
|--------|---------------------------------|
| 2 Each | Electric Hinges, Model 1104*    |
| 2 Each | M1510 or C1510 Fail Safe Locks* |

\*Electric hinges and electric locks are not included, but must be ordered separately with the Series 6100 system.

## Description of System Function

When the bathroom is not occupied, both doors are unlocked and all indicators are extinguished. Upon entering the bathroom from one of the rooms, the occupant depresses the inside pushbutton switch to lock both doors (both doors must be closed in order for them to lock). When the doors lock, the red indicators inside the bathroom indicate that both doors are locked from the outside. The green indicators outside the bathroom indicate that the bathroom is occupied.

**Note:** Both doors are always free egress and can be unlocked mechanically from the outside with a key. When the occupant exits either door, both doors automatically return to the unlocked condition and all indicators are extinguished.

# Series 6100 | Communicating Bath Door System

## How to Order

| 1<br>Model | 2<br>Electric Locking Device | 3<br>1104 Electric Hinge |
|------------|------------------------------|--------------------------|
| 6100       | A or B                       |                          |

### 1. 6100 System

|      |                                |
|------|--------------------------------|
| 6100 | Communicating Bath Door System |
|------|--------------------------------|

### 2. Electric Locking Device

Distributors supply ACSI with mortise or cylindrical locks for modification. Please supply the lock manufacturer's full part number. Example: L9070, 8237, 8808, ND80, 3357, etc.

|             |                            |
|-------------|----------------------------|
| A (2) M1510 | Electric Mortise Locks     |
| B (2) C1510 | Electric Cylindrical Locks |

### 3. 1104 Electric Hinges

Please specify manufacturer, weight, size and finish of the hinge required.

(2) Hager BB1279 4.5x4.5 26D 1104

(2) Stanley FBB191 5.0x4.5 10B 1104

**Note:** System may also be furnished with an emergency release device; i.e., 1330-3 Emergency Release or 1320-1 Pushbutton Switch.

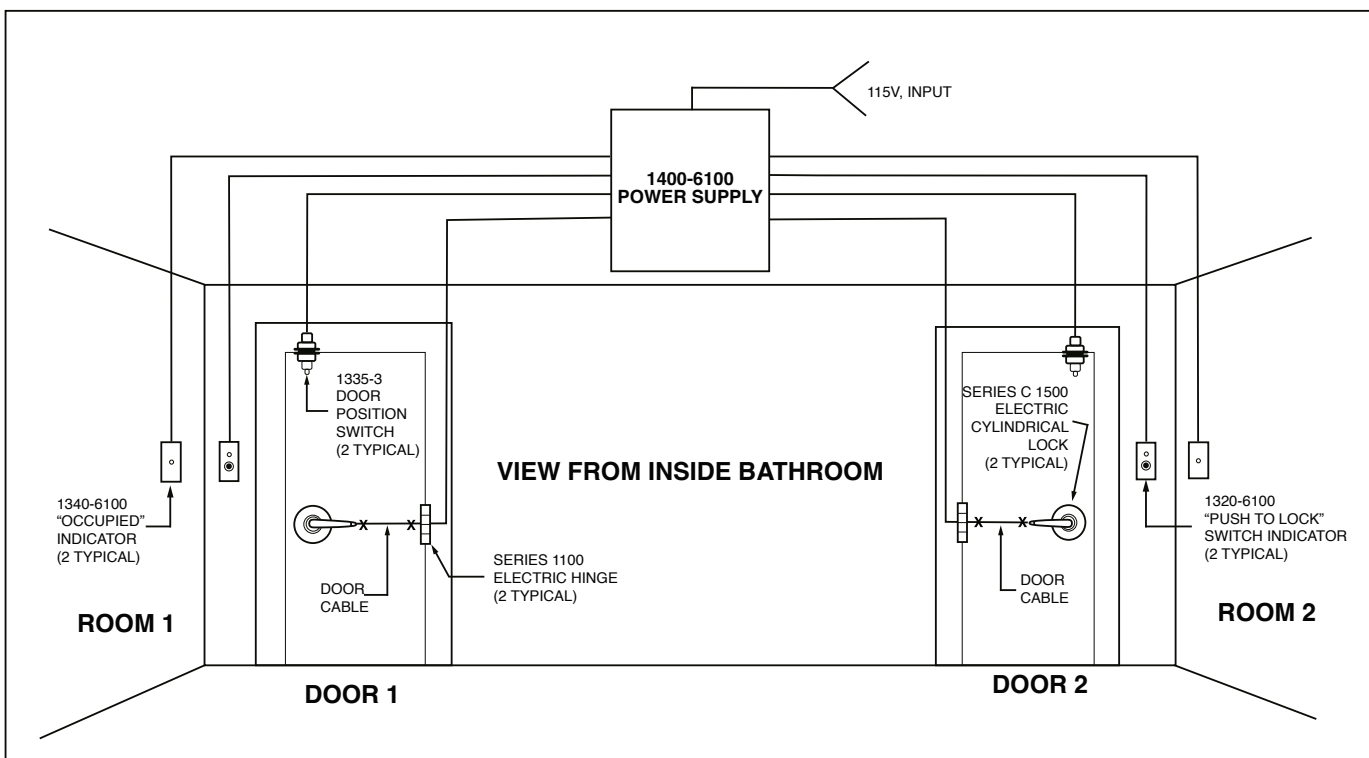

# Series 8500

## Gemini Locking Systems

---



# ACSI

2720 Clark Avenue  
St. Louis, MO 63103  
(314) 652-5588  
(314) 652-2090 FAX

[www.acsi-inc.com](http://www.acsi-inc.com)

1-800-753-5558

# Series 8500 | Gemini Locking Systems

ACSI Series 8500 Gemini Locking System provides safety and security for stairtower doors or controlled areas where both locking and latching are required. The Gemini system allows remote electric locking or unlocking while conforming to life-safety codes. The system consists of two components: a Gemini modified mortise lockset and a frame mounted Gemini operator.

## Features

- UL Listed Gemini mortise lock - no special door prep
- UL Listed Gemini operator located in the frame
- Ability to work with a wide range of mortise lock manufacturers:
  - Arrow
  - Corbin Russwin
  - Schlage
- Fail Safe (Power Lock)
  - Outside trim is locked when power is applied and unlocked when power is removed (storeroom function when energized). Lockset will unlock in the event of a power failure (passage function).
- Fail Secure (Power Unlock)
  - Outside trim is unlocked when power is applied and locked when power is removed. Lockset will lock in the event of a power failure.
- 24VDC or 24VAC/DC
- Optional quick connect cable
- Continuous duty rated
- Heavy-duty stainless steel housing
- Security monitoring available
- Interface with life-safety systems

- Mechanical key override
  - When key cylinders are provided in the locks, the latch bolt may be momentarily retracted with key even though electrically locked. **Note:** Locks that are electrically unlocked may not be locked via the key cylinder.
- Easy installation: Gemini operator fits easily into 2" face frames. Only one wiring termination.

## Series 8500 Typical Installation

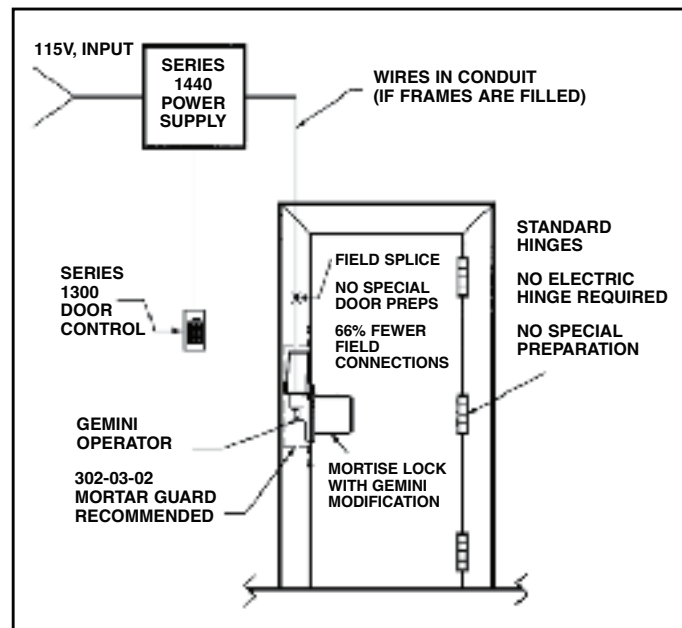

# Series 8500 | Gemini Locking Systems

## How to Order

| 1<br>GEMINI<br>OPERATOR | 2<br>LOCK TYPE | 3<br>CONTROL<br>MODE | 4<br>OPERATING<br>VOLTAGE | 5<br>QUICK CONNECT<br>CABLE | 6<br>SECURITY<br>MONITORING | 7<br>FINISH | 8<br>HANDING | 9<br>LOCK PART # |
|-------------------------|----------------|----------------------|---------------------------|-----------------------------|-----------------------------|-------------|--------------|------------------|
| 8500                    | M1             | PL                   | 24VDC                     | QC                          | CLS                         | 26D         | LH           | L9070            |
| 8500F                   | M2             | PUL                  | 24VAC/DC                  |                             | OLS                         |             | RH           |                  |
|                         |                |                      |                           |                             |                             |             | LHR          |                  |
|                         |                |                      |                           |                             |                             |             | RHR          |                  |

## Example:

| GEMINI<br>OPERATOR | LOCK TYPE | CONTROL<br>MODE | OPERATING<br>VOLTAGE | QUICK CONNECT<br>CABLE | SECURITY<br>MONITORING | FINISH | HANDING | LOCK PART # |
|--------------------|-----------|-----------------|----------------------|------------------------|------------------------|--------|---------|-------------|
| 8500               | M1        | PL              | 24VDC                | QC                     | CLS                    | 26D    | LH      | L9070       |

### 1. Gemini Operator LIST PRICE

|       |   |              |
|-------|---|--------------|
| 8500  | The standard Gemini operator is designed for 2" face frame applications and fits a standard ANSI 4-7/8" frame prep.                                   | <b>\$840</b> |
| 8500F | Also designed for 2" face frame applications, this operator is supplied with an oversized strikeplate for easy installation in retrofit applications. | <b>\$860</b> |

### 6. Security Monitoring LIST PRICE

|     |   |              |
|-----|---|--------------|
| CLS | Closed Loop Secure – Monitor<br>• When lock is secure (latch in strike-operator in locked position), monitor loop is a closed circuit. The circuit opens if security is breached. | <b>\$200</b> |
| OLS | Open Loop Secure – Monitor<br>• When lock is secure (latch in strike-operator in locked position), monitor loop is an open circuit. The circuit closes if security is breached.   | <b>\$200</b> |

*Note: Leave this space blank if not required.*

### 2. Lock Type LIST PRICE

|    |  |             |
|----|--|-------------|
| M1 | Mortise lock with one side (lever or knob) locked    | <b>STD</b>  |
| M2 | Mortise lock with both sides (lever and knob) locked | <b>\$40</b> |

### 7. Finish LIST PRICE

Specify US standard architectural hardware finish as required. **STD**

### 3. Control Mode LIST PRICE

|     |                            |              |
|-----|----------------------------|--------------|
| PL  | Power Lock (Fail Safe)     | <b>STD</b>   |
| PUL | Power Unlock (Fail Secure) | <b>\$200</b> |

### 8. Handing LIST PRICE

|     |                    |            |
|-----|--------------------|------------|
| LH  | Left Hand          | <b>STD</b> |
| RH  | Right Hand         | <b>STD</b> |
| LHR | Left Hand Reverse  | <b>STD</b> |
| RHR | Right Hand Reverse | <b>STD</b> |

### 4. Operating Voltage LIST PRICE

|          |             |
|----------|-------------|
| 24VDC    | <b>STD</b>  |
| 24VAC/DC | <b>\$38</b> |

### 9. Lock Part Number LIST PRICE

Distributors supply ACSI with mortise locks for modification. **STD**  
Please supply the lock manufacturer's full part number.

**Example:** L9070, 2055, BM17

*Note: Refer to the last page of this catalog section for a complete listing of locks required by ACSI.*

### 5. Quick Connect Cable LIST PRICE

|    |  |             |
|----|--|-------------|
| QC | An optional quick connect cable 10' in length with stripped wires at one end for splicing into an electrical box or power supply and with a connector on one end for quick connect to the Gemini operator is automatically supplied with a matching connector. | <b>\$70</b> |
|----|--|-------------|

*Note: Leave this space blank if not required.*

### Accessories LIST PRICE

|           |                          |             |
|-----------|--------------------------|-------------|
| 302-03-02 | Gemini Mortar Guard, 15" | <b>\$44</b> |
|-----------|--------------------------|-------------|

1-800-753-5558



# Series 8500 | Gemini Locking Systems

## Gemini Lock Modification Listing (Indicates Locksets that are UL Listed)

**Note:** If you do not find the lock of your choice listed, please consult with our factory engineering staff. We may request that you send a sample for further evaluation.

| Arrow | Corbin Russwin | Schlage |
|-------|----------------|---------|
| AM17  | 2055           | L9050   |
| BM17  |                | L9070   |
|       |                | L9080*  |

\*L9080 must be supplied with extra spring cage to compensate for lever sag of outside trim.

## Gemini Comparison Chart

| ACSI-Gemini        | SDC HiTower |
|--------------------|-------------|
| <b>Fail Safe</b>   |             |
| 8500-M1-PL         | 7550, 7540  |
| 8500-M2-PL         | 7530        |
| 8500-M1 or M2-PL*  | 7510, 7520  |
| <b>Fail Secure</b> |             |
| 8500-M1-PUL        | 7570        |
| 8500-M2-PUL        | 7560        |

\*Please consult the factory for proper part number.

| ACSI      | Description                    | SDC       |
|-----------|--------------------------------|-----------|
| CLS, OLS  | Monitoring                     | 9A, 69A   |
| QC        | Quick Connect Cable            | SC-10     |
| 302-03-02 | Mortar Guard for 2" Face Frame | 7500-EB-S |

## Electrical Specifications

### Gemini Operator

- 24VAC/DC, 600mA

### Monitoring Contact Rating

- 0.5A @ 30VDC

